

# DISD

## SD380

Main Performance Parameters (Standard Configuration)

Total Operating Mass :	19,000 KG	Max. Traction Force :	176 KN
Rated Load :	6,000 KG	Max. Dump Height :	3,200 mm
Rated Power :	178 KW	Min. Turning Radius(Outside tire edge) :	6,058 mm
Rated Bucket Capacity :	3.2~5.0	Overall Dimensions	
Max. Breakout Force :	183 KN	(Length X Width X Height) :	8,434 X 3,026 X 3,450 mm



DIPBE-02-2005

<https://www.tractormanualpdf.info/>

**DISD**  
A Doosan brand



# The most efficient expert in loose bulk materials transfer!

Integrated with 40 years of international standard professional loader manufacturing technologies, Little Giant is suitable for Emerging countries's working conditions.



## SD380

### Key features

#### MAIN PERFORMANCE FEATURES

- The Weichai Steyr low-RPM engine features an oil pump that has accepted professional test bench special adjustment, making engine acceleration performance much higher than industry level.
- Reasonable match between transmission and torque converter as well as fully play of engine power enable the whole machine to deliver stronger traction force-14% higher than industry level.
- The advanced Doosan drive axle and improved differential bevel gear process have increased gear flexural strength by 34.6%, enhancing the reliability of the drive axle and extending its lifespan.
- With 3,400mm wheel base and small turning radius of 6058mm, the machine model is designed for any material, with greater agility of movement and more efficient operation.
- Manufactured according to a reasonable and optimized design based on typical working conditions, the hydraulic system adopts double-pump confluence technology, and makes full use of power and energy, thereby minimizing engine oil pressure load and power loss and enabling miniaturization of the hydraulic pump.
- The hydraulic cylinder seals and hydraulic parts in main connecting areas are all imported PARKER brand parts, effectively improving the reliability of the hydraulic system.
- By using Doosan patented technology and a redesigned layout and materials, the cooling system significantly reduces hydraulic oil temperature and water temperature during operation and is capable of ensuring the unit's capacity to work 24hrs continuously under 45 °C of temperature without risk of overheating.
- Paints imported from South Korea offer more outstanding anti-rust and anti-fade effects.



Materials and Specifications in the catalogue are subject to change without notice.

Perfect Match between Power and Speed, Unrivalled Work Efficiency in the Industry

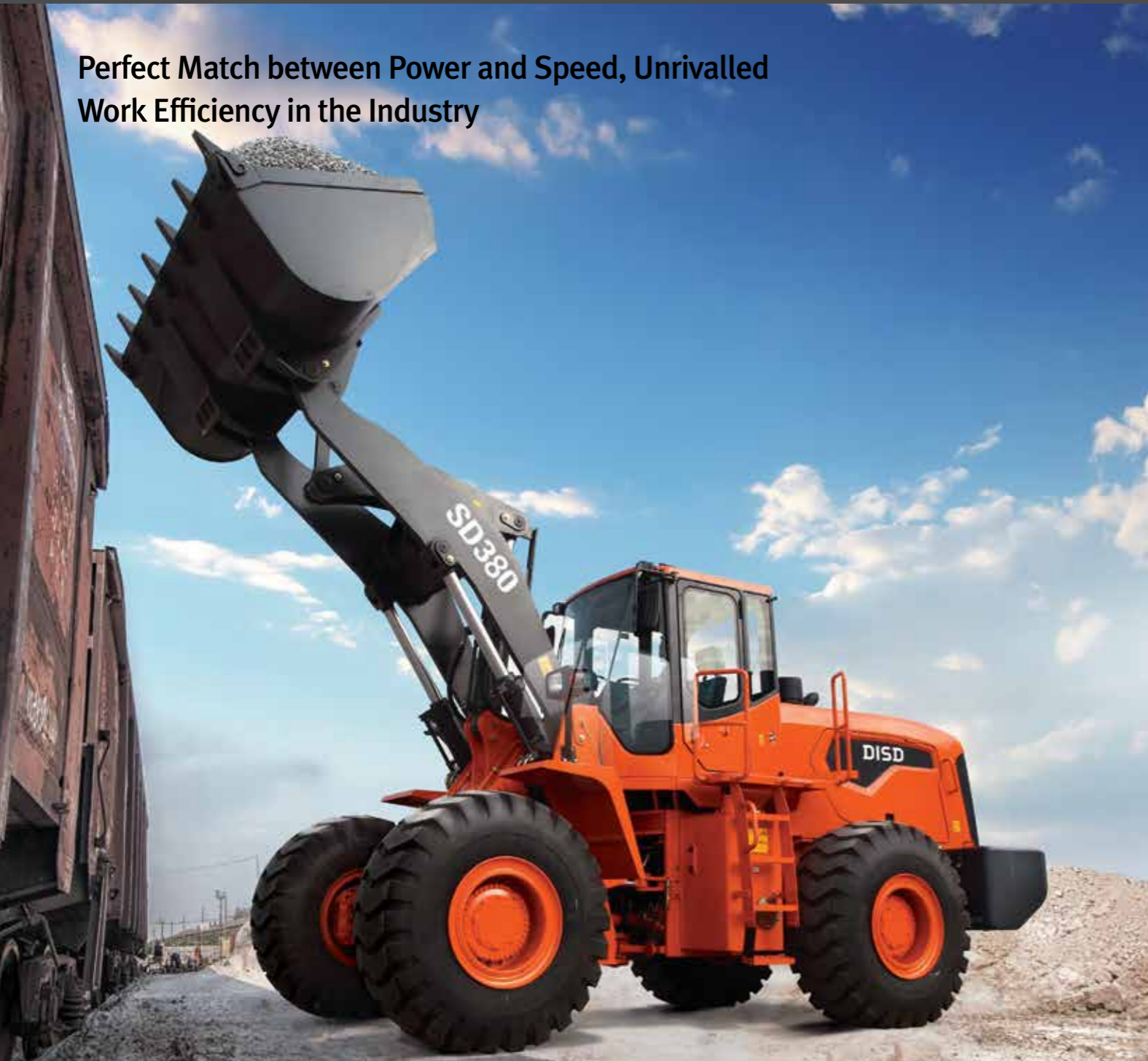

## “DISD – A Pioneer of Low-RPM Engine Matching Technology!”

### Engine

With 178KW rated power and 2,000 rpm rated rotation, the Weichai WD10G240E343 engine has been adjusted on the basis of condition subdivision, enabling lower fuel consumption in the most commonly used operating states.



### Triple fuel filter

Triple fuel filters protect engine and fuel system from low quality fuel and make engine life longer



### GearBox

The torque converter gearbox from German manufacturer ZF perfectly matches the engine, while Doosan's uniquely designed and patented gearshift-shock-improving technology efficiently prolongs the service life of the gearbox.

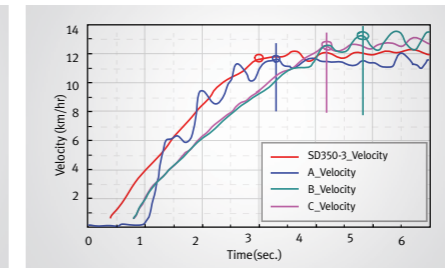

### Acceleration Performance Exceeds Industry Level

The injection pump has undergone special debugging at a professional test bench and features greatly improved engine acceleration performance, enabling Doosan machines to start work in the 3rd second while other brand machines are still in the acceleration phase.

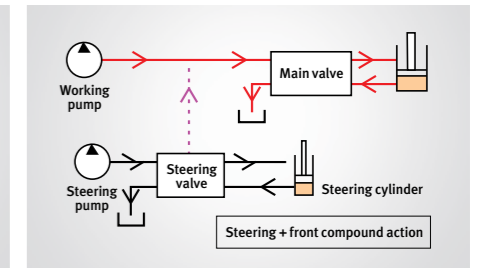

### Advanced Double Pump Confluence Technology

The hydraulic system uses condition subdivision to realize a reasonable match, and makes full use of power and energy, thereby minimizing engine oil pressure load and power loss and enabling miniaturization of the hydraulic pump.

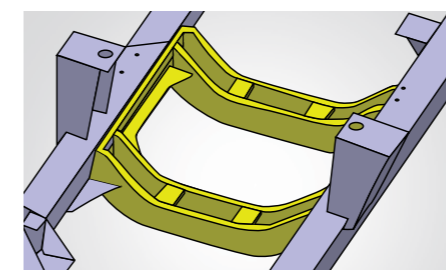

Connecting parts of swing frame adopt a reinforcement design to offer greater strength.

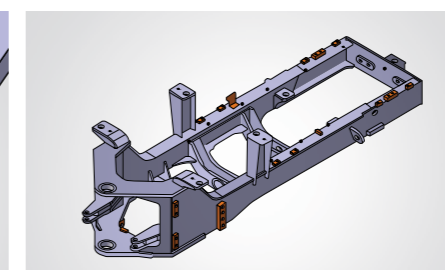

Thanks to the box-shaped structure of the rear frame side plates, the enhanced frame strength makes it easy to meet the challenge posed by harsh working conditions.

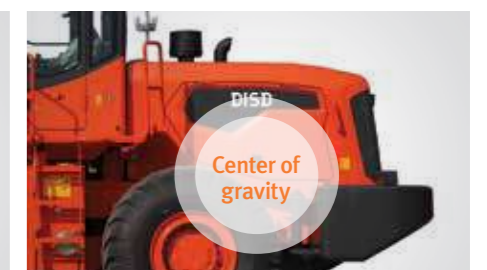

The whole center of gravity has been moved backward, and the real axle load bearing proportion has been increased to 54% resulting in a tipping load 10% higher than the industry level and greatly improved product stability.

Increasing the tilting angle  $a_3$  in the carry position allows the machine to move on bumpy roads without spilling any material, while increasing the dump angle  $a_2$  enables the machine to dump materials more quickly and completely.



With 3,400mm wheelbase and 6,058mm turning radius at outside tire edge, which is the smallest among similar products in the industry, Doosan's machine is specifically designed for light density material working conditions and offers greater overall flexibility, as well as more apparent advantages especially in confined work spaces.

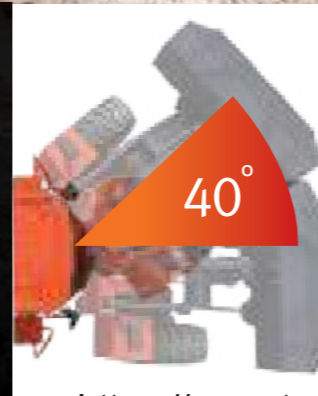

# Reliability

Low Oil Temperature for High Quality

# SD380

Greater Reliability Ensured by Efficient Cooling, 24 Hours Continuous Work under 45°C Environment without Risk of Overheating





**Cooling System**

By improving the cooling system's layout and materials, DISD's unique patented cooling technology greatly reduces hydraulic oil temperature and coolant temperature during operation time, thus resolving the high temperature problem that has been hanging over the industry for many years. The machine is guaranteed not to overheat even after 24hrs of continuous work under 45°C atmospheric temperature.





The hinge pins for operating devices in 6 positions have a radius of 5-10mm larger than similar products in the industry. The pin roll sets are made of highly wear-resistant materials and processed with a special heat treatment technology, thus offering greater durability and second-hand residual value.

The method of articulating the front and rear frames has been changed by replacing tapered roller bearings with joint bearings, effectively preventing such common problems as loose and breakage in the industry.

**Hydraulic Seal Piping**  
The adoption of PARKER brand parts has greatly improved the quality of the hydraulic system. In addition, all of the hydraulic parts must satisfy the endurance test standard in South Korea to ensure the high reliability of Doosan's loaders.

**Drive Axle**

Robust design and improved differential bevel gear processing have increased gear flexural strength by 34.6%, improving the reliability of the drive axle and extending its lifespan.

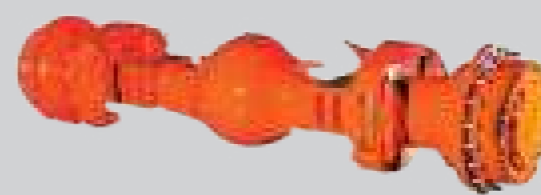



**Transmission Shaft** The use of a reinforced drive shaft and a self-locking nut for the drive shaft's connecting bolt has improved the durability of the drive system.



**Hydraulic System Action Time: 10.6 seconds**  
The sum total of the times of the three actions (lifting 5.5s, dumping 1.5s, lowering 3.6s) is 10.6s, which is much faster than the industry level, leading to a shorter cycle operation time and greater efficiency.

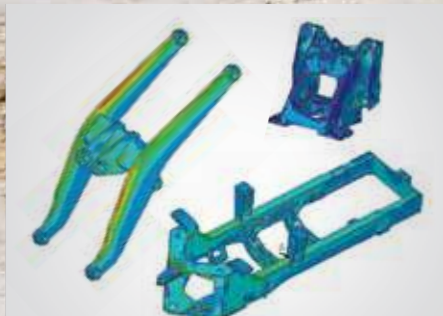

**Structural Parts**  
Made of high-strength steel and calculated using finite element analysis software, it guarantees easy operations under the most onerous and toughest working conditions.



**Multi-Way Valve**  
Adoption of new solid valves of wellknown brands and processed with highprecision, delivering good micro-motion performance, reduced internal leakage, and a prolonged service life.



**Low Temperature Startup (Flame Preheating)**  
The low temperature startup device (Diesel electric heating + Air flame preheating) effectively improves work situations where it is difficult to startup in low temperatures during winter.

# Comfort

Technology that Respects Human Health and Safety

The whole system comes with a standard integrated driving system that respects human health and safety, relieves fatigue, and improves work efficiency.



## Cab Vision

DISD's New Full Vision Cab adopts Korean technology. The viewpoint has been moved forward and the front visual field has been broadened by 25%, while the installation of high-performance damping material guarantees superior sealing, sound insulation, shock absorption effects.

# SD380

The upgraded SD380 model guides operations, improves work efficiency, relieves fatigue, and is operated more comfortably and easily. The operating environment in the cab boasts an optimized ergonomic design, has plenty of space and a good visual field, and delivers safe and reliable protection on the basis of a people-oriented conception.



## Cab

The cab's interior features an ergonomic design, a super-large driving space, wider front and rear visual fields, a user-friendly design for easier operability, and industry-leading driving comfort. A new model of shock pad is used to provide stronger durability and reduced shock and noise, effectively relieving the driver's fatigue.



Adjustable Armrest

## Deluxe Seat

High back, deep-seated position, dual armrests and multi-level spring shock absorption guarantee a comfortable operation.



## Shock Pad

A new model of shock pad is used to provide stronger durability and reduced shock and noise, effectively relieving the driver's fatigue.



## Entertainment System

High-quality audio entertainment systems (MP3, radio) create a pleasant and relaxed work environment. A USB port is also available for charging mobile phones.



Rear door opening angle increased up to 65°, making engine and radiator maintenance more convenient.



All-metal hood, greater durability



Both sides of the hood can be opened to the side

### Easier Replacement

The use of quick-change brake discs allows the user to check brake pads for excessive wear at any time and change the brake pads more easily without needing to remove the tires.



The booster pump delivers a higher augmented-thrust ratio, more stable braking performance, and more convenient daily maintenance thanks to its being mounted on the body's side.

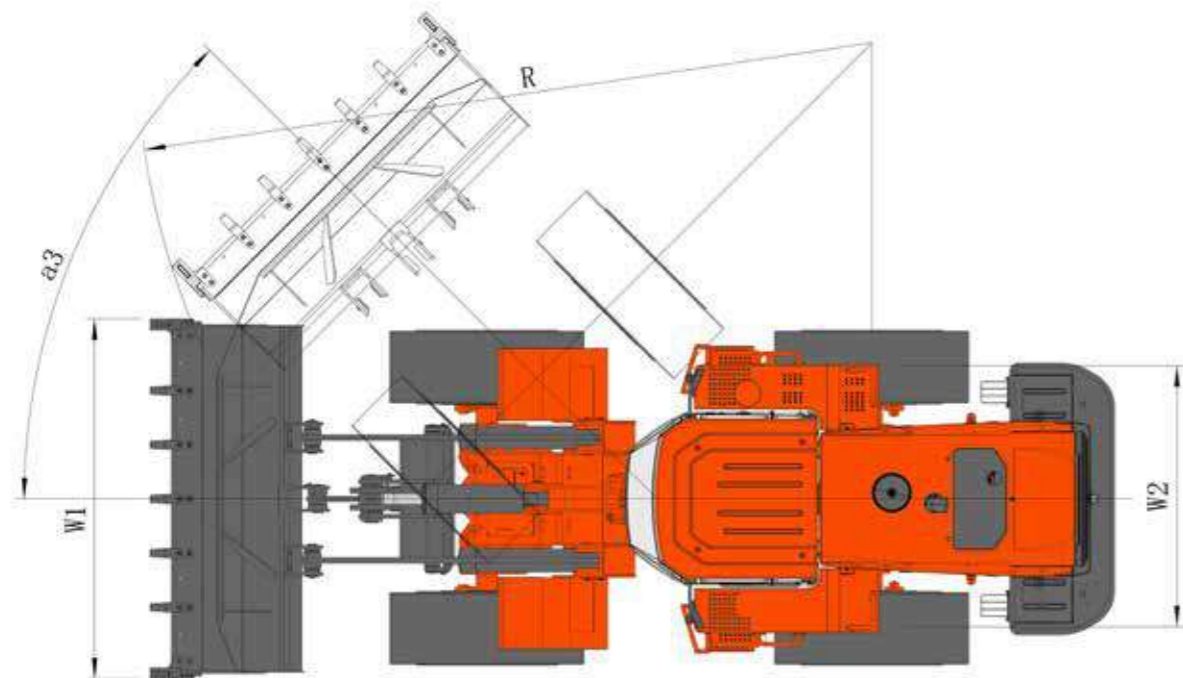
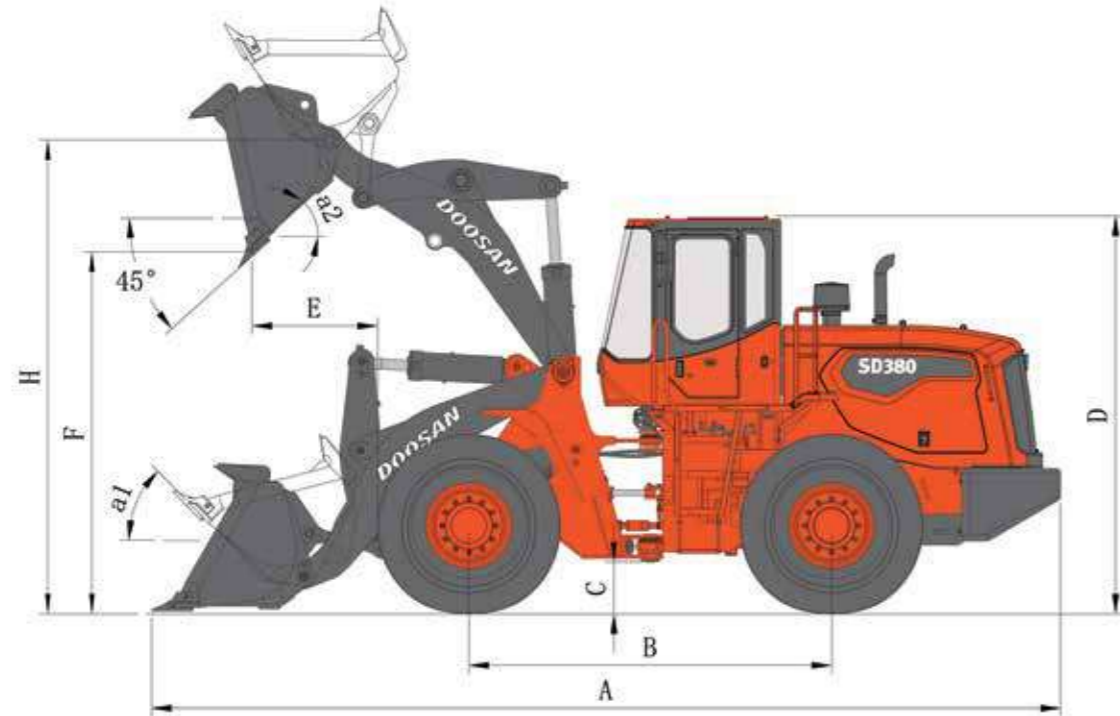

## General Specification

Operating Weight	19.0 ton
Machine Dimensions (A x W1 x D)	8,434 x 3,026 x 3,450 mm
Ground Clearance (C)	416 mm
Wheel Base (B)	3,400 mm
Tread (W2)	2,174 mm
Turning Radius (R)	6,740 mm
Steering Angle (a3)	40 deg

## Working Range

Dumping Height (F)	3,200 mm
Dump Reach (E)	1,165 mm
Max. Dump Angle (a2)	47°
Max. Tilt Angle on Ground (a1)	46°

## General parameters

Bucket capacity	3.7 m <sup>3</sup> Cutting Edge
Operating weight	19,000 KG
Overall length x width x height (mm)	8540 x 3035 x 3450 mm
Rated load	6,000 KG
Wheelbase	3400 mm
Tread	2,174 mm
Ground clearance	416 mm

## Engine

Model	Weichai Steyr engine WD10G240E343 (turbocharged)
Rated power	178 KW
Rated speed	2,000 rpm
Number of cylinders/bore & stroke(mm)	6 / 126 x 130
Displacement	9.7 L
Max. torque	1100N.m / 1,300 - 1,500 rpm

## Optional items of equipment

Bucket	3.5 m <sup>3</sup>
Enlarged coal bucket	5.0 m <sup>3</sup>
Extended arm (dump height)	3,690 mm
Quick coupler bucket	3.7 m <sup>3</sup> Cutting Edge
Timber grapples	

## Transmission system

Torque converter	Twin turbo
Gear box	
Planetary gear	Multiple disc Anti-shock power shift
Forward Speed(I II III IV)	6.7 / 12.5 / 23.4 / 35.1 km/hr
Drive form	Four-wheel drive
Rear axle swing angle	11°
Tire	23.5 - 25 - 20 PR
Max. traction force	176 KN
Max. climb angle	30°
Max. steering angle	40°
Min. turning radius (Bucket edge)	6,740 mm

## Capacity

Fuel tank capacity	350 L
Hydraulic oil tank capacity	250 L
Engine oil	20 L
Gear box oil	45 L
Drive axle oil (front/rear)	27 L / 27 L

## Working device

Max. dump height	3,200 mm
Dump reach	1,165 mm
Max. dump angle	47°
Max. breakout force	183 KN

## Hydraulic system

Pump type	Gear pump
Pump displacement	104.9mL/r
System operating pressure	21MPa
Front cycle time	
	Lifting Dumping Lowering Total
	5.5 s 1.5 s 3.6 s 10.6 s

## Noise

Noise at driving position	≤80 dB(A)
Machine exterior radiated noise	≤108.7 dB(A)

## Loading Material Unit Weight (Please determine the precise loading material weight according to the densities of the different materials given in the Table.)

Material Name	Density Kg/m <sup>3</sup>	Material Name	Density Kg/m <sup>3</sup>	Material Name	Density Kg/m <sup>3</sup>
Rubble	1,600	Dry	1,550	Sand rock	Crushed 1,550
Mine refuse	650	Wet	1,725		Solid 2,300
	Dry excavated 1,485	Soil	Fine clay 1,125		Loose and dry 1,440
Clay	Wet excavated 14725		Tight 1,840	Sand	Slightly wet 1,680
	Natural 1,650		Soft slurry 1730		Wet 1,850
Clay and gravel	Dry 11,185		Dry compacted soil 1,520		Compacted wet sand 1,850
	Wet 1,650	Granite	Crushed 1,650	Sand and gravel	Dry 1,730
Coal	Smoke-free raw coal 1,190		Solid 2,800		Wet 2,000
	Smoke raw coal 950		Crushed 1,810	Furnace cinders	Crushed 1,760
Weathered granite	75% rock,25% soil 1955	Plaster	Crushed 1,600		Solid 2,100
	50% rock,50% soil 1,725		Solid 2,780	Trappide	Crushed 1,740
	25% rock, 75% soil 1,585	Limestone	Crushed 1,550		Solid 2,880
	Pit gravel 1,900		Solid 2,600	Hematite	2,460
Gravel	Dry 1,485	Peat coal	Dry 415	Magnetite	2,780
	Dry(1/4" -2") 1,650		Wet 1,125	Iron pyrites	2,580
	Wet(1/4" -2") 2,015	Alumina	1,425	Taconite	2,800