

Operator's Manual



McCORMICK®
FARMALL®
Super C
Tractor

© Registered Trade-Mark

INTERNATIONAL HARVESTER COMPANY

180 North Michigan Ave.

Chicago 1, Illinois, U.S.A.

<https://www.tractormanualpdf.info/>

CONTENTS

Description	Page No.
INTRODUCTION	Inside
Delivery report (to be filled in when tractor is delivered).....	Front Cover
General.....	2
Serial numbers, engine and tractor.....	2
DESCRIPTION	
Before starting your new tractor.....	7
Instruments and controls.....	4 to 6
Preparing your tractor for each day's work.....	8, 9
Views of the tractor.....	3
OPERATING YOUR TRACTOR	
Driving the tractor.....	16 to 18
Hitching the tractor to the implement (without Fast-Hitch).....	29, 30
Operating a distillate engine on distillate.....	13 to 15
Operating a distillate engine on gasoline.....	15, 16
Operating a gasoline engine.....	10 to 12
Operating a kerosene engine.....	15
Operating the belt pulley.....	32
Operating the Farmall Touch-Control system.....	18, 19
Operating the Fast-Hitch System.....	21 to 29
Operating the Hydraulic Remote Control system.....	19 to 21
Operating the pneumatic tire pump.....	32
Operating the power take-off.....	30, 31
LUBRICATION	
General engine lubrication.....	33
Greasing the front wheels.....	35
Lubrication guide.....	37 to 41
Lubricating oil and grease specifications.....	35, 36
Oil filter.....	33, 34
MAINTENANCE	
Adjustable wide front axle.....	72, 73
Air cleaning system.....	49, 50
Battery ignition unit.....	51 to 54
Brakes.....	67, 68
Carburetor.....	43 to 45
Clutch.....	68, 69
Cold weather precautions.....	45, 46
Cooling system.....	46 to 49
Front wheels.....	70, 71
Fuel strainer.....	43
Magneto (tractors so equipped).....	54 to 57
Minor engine service operations.....	66
Periodic inspections.....	42, 43
Pneumatic tires.....	74 to 76
Rear wheels.....	74
Seat.....	78
Spark plugs and cables.....	51
Starting and lighting equipment.....	58 to 63
Starting engines that have been in storage.....	83
Storage battery.....	64, 65
Storing and housing your tractor.....	83
Touch-Control system and Hydraulic Remote Control system.....	76 to 78
Trouble shooting.....	79 to 82
Valve clearance adjustment.....	66
SPECIAL EQUIPMENT	84 to 93
SPECIFICATIONS	94, 95
COMPREHENSIVE INDEX	96 to 98

INTRODUCTION

Assembled in this book are operating and maintenance instructions for the Farmall Super C. This material has been prepared in detail in the hope that it will help you to better understand the correct care and efficient operation of your tractor.

If you should need information not given in this manual, or require the services of a trained mechanic, get in touch with the International Harvester dealer in your locality. Dealers are kept informed on the latest methods of servicing tractors. They carry stocks of IH parts, and are backed in every case by the full facilities of a nearby International Harvester District Office.

Throughout this manual the use of the terms LEFT, RIGHT, FRONT, and REAR must be understood to avoid confusion when following instructions. LEFT and RIGHT indicate the left and right sides of the tractor when facing forward in the driver's seat. Reference to FRONT indicates the radiator end of the tractor; to REAR, the drawbar end. See *Illust. 2*.

The illustrations in this manual are numbered to correspond with the pages on which they appear; for example, *Illust. 5, 6A, 6B, and 6C, are on page 6.*

When in need of parts, always specify the tractor and engine serial numbers. The tractor serial

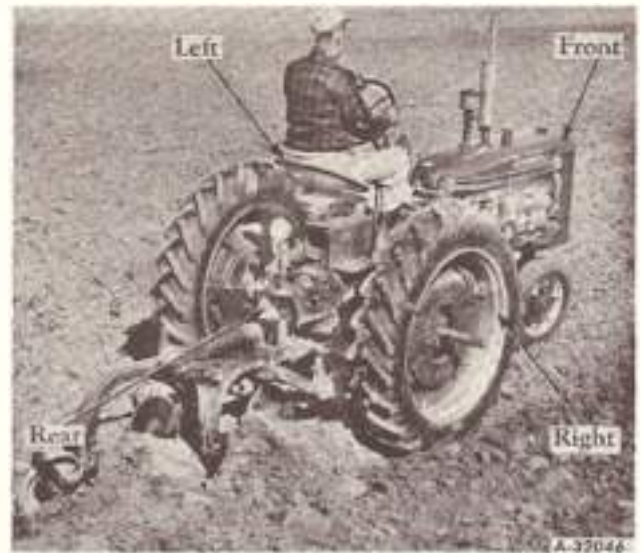

Illust. 2

number is stamped on a name plate attached to the tool box and seat support on the right side of the tractor. See *Illust. 2A*. The serial number is preceded by the letters FC. The engine serial number is stamped on the right side of the engine crankcase above the battery ignition unit. See *Illust. 2B*. This serial number is preceded by the letters FCM.

For ready reference we suggest that you write these serial numbers in the spaces provided on the Delivery Report.

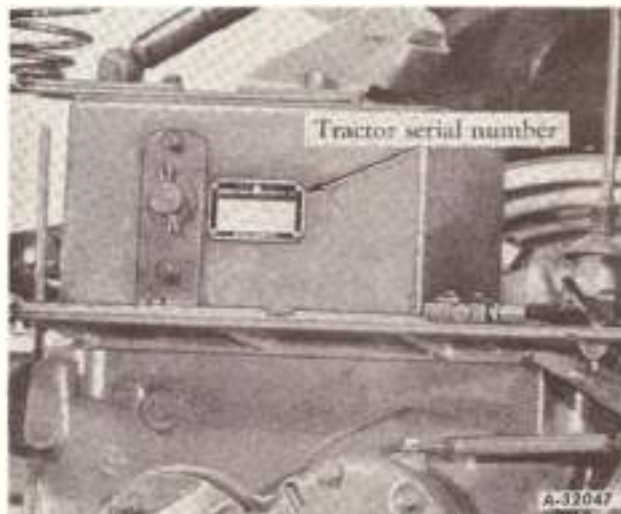

Illust. 2A

Location of the tractor serial number.

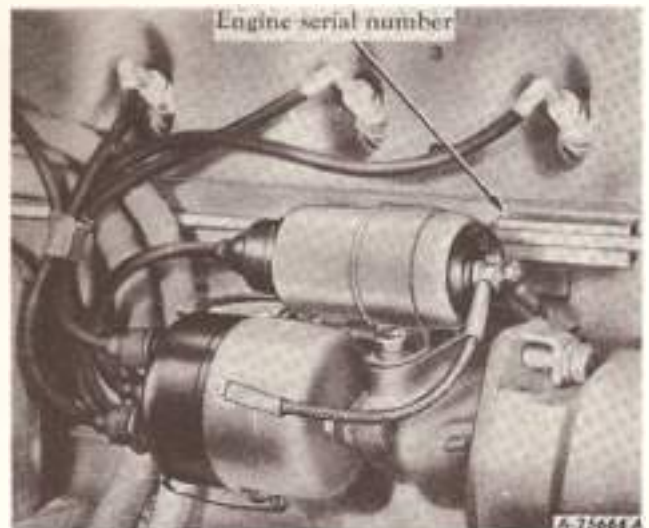

Illust. 2B

Location of the engine serial number.

DESCRIPTION

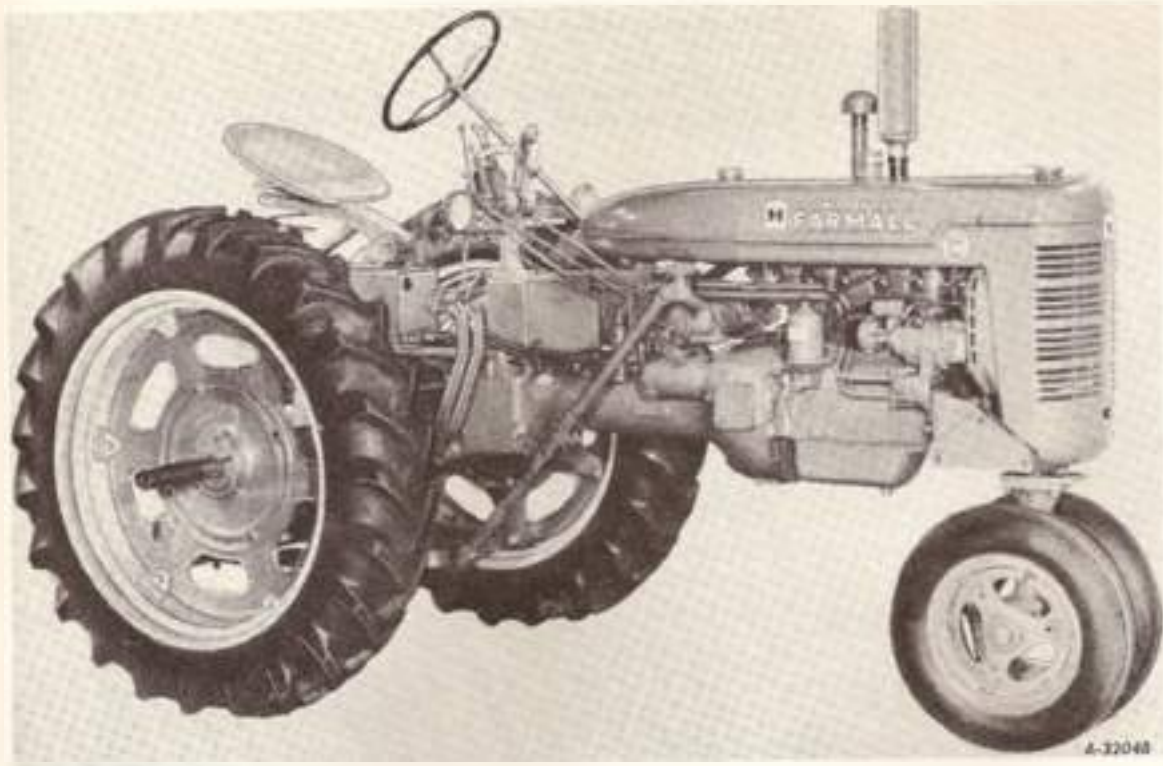

Illustr 3
Right side view of the tractor with Fast-Hitch.

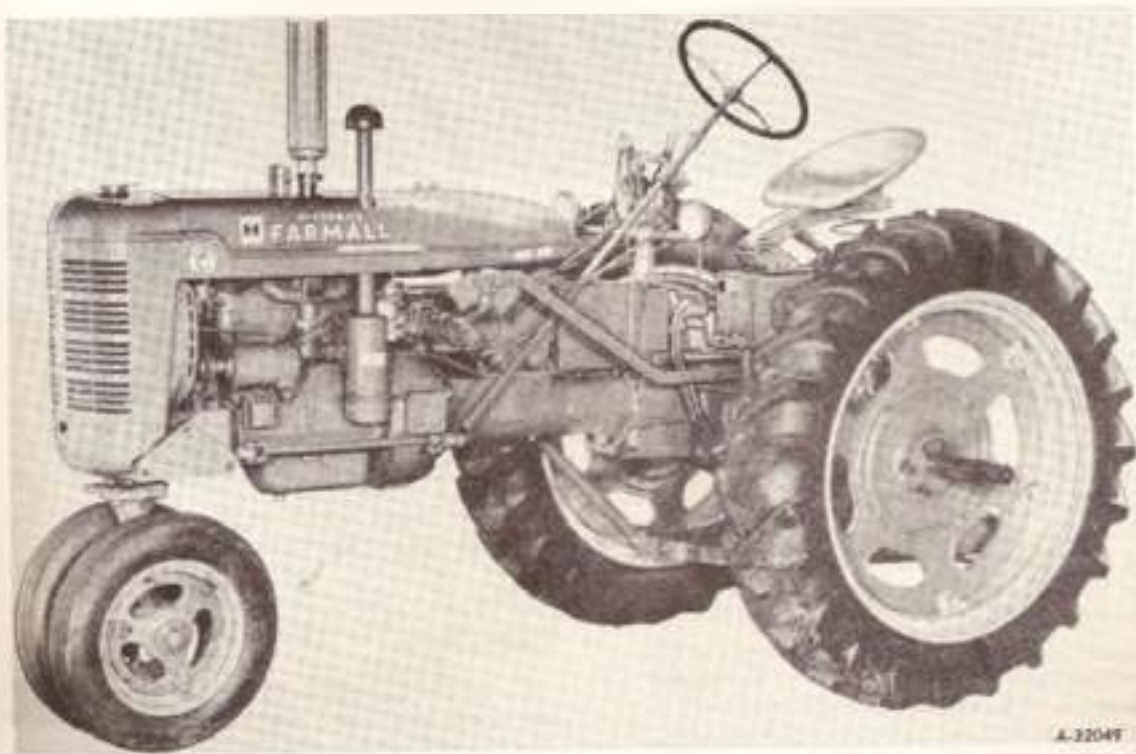

Illustr 3A
Left side view of the tractor with Fast-Hitch

Instruments and Controls

A variety of special equipment is available for use with the Farmall Super C. The instructions for operating and maintaining the special equipment have been included in the instructions for operating and maintaining the tractor. Disregard the instructions for special equipment not on your tractor.

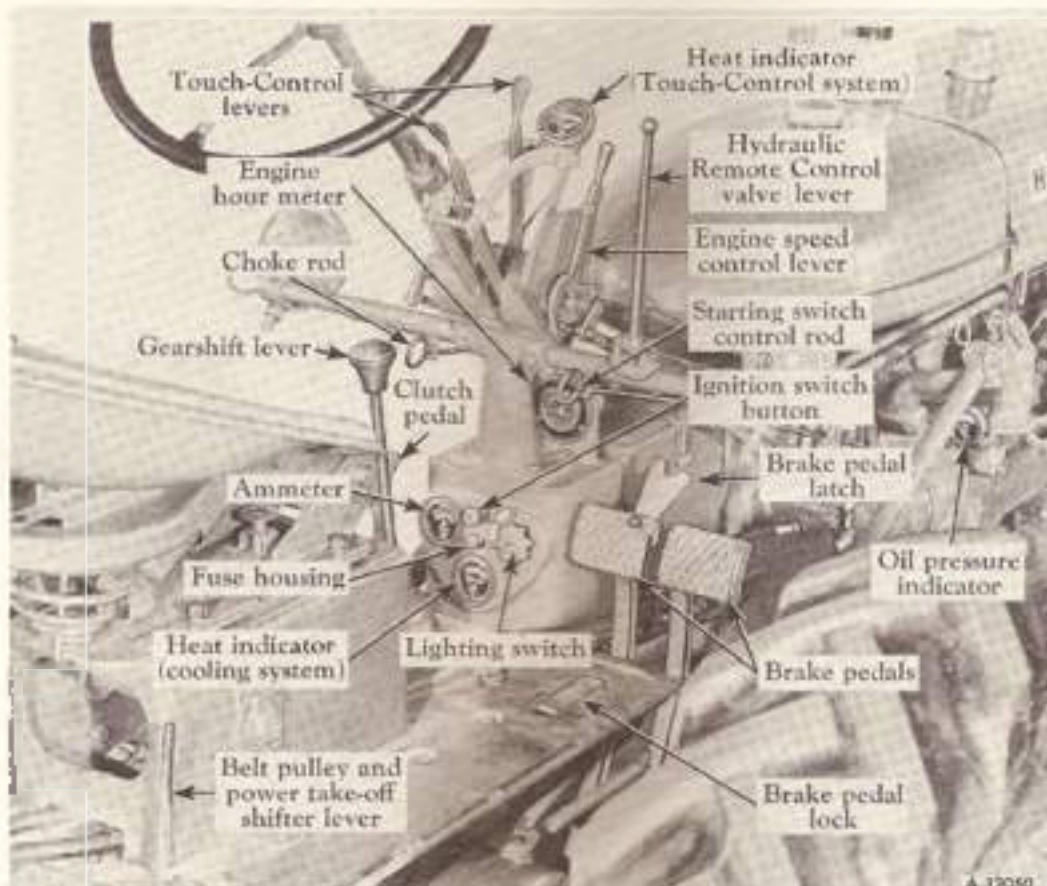

Illustration 4

Location of instruments and controls.

Brake Pedals

These pedals are used to stop the tractor, to hold the tractor in a stationary position, or to assist in making sharp turns as outlined below:

To stop the tractor, depress both pedals at the same time. Before driving the tractor in high gear, always latch the pedals together.

To hold the tractor in a stationary position, latch the pedals together, depress them, and lock them in this depressed position by using the brake pedal lock.

To assist in making a sharp turn, operate the pedals individually, depressing the pedal on the side toward which the turn is to be made.

The brake pedal latch (Illustrations 4 and 18) is used to latch both brake pedals together, causing the brakes to operate simultaneously.

The brake pedal lock (Illustration 18) is used to lock the brake pedals in the depressed position. This prevents the tractor from moving.

Clutch Pedal

This pedal, when depressed all the way, disengages the engine from the transmission.

Choke Rod

The choke rod makes it possible to regulate the carburetor choke from the driver's seat. Pulling out on the choke rod closes the carburetor choke for starting the engine; pushing it back in opens the choke.

Engine Speed Control Lever

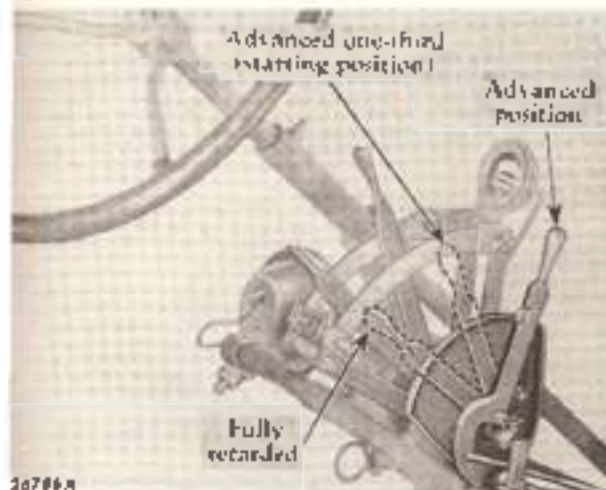

Illustr. 5

Various positions of the engine speed control lever.

This lever controls the speed of the engine and, when set in a given position, will maintain a uniform engine speed even though the engine load may vary.

The rated or maximum full load governed speed is 1,650 r.p.m.; maximum idle speed is approximately 815 r.p.m.; minimum idle speed (hand throttle) is 30 to 450 r.p.m. with the engine speed control lever fully retarded. See *Illustr. 5*. Never operate the engine at more than the regular governed speed. Excessive speeds are harmful.

The governor is set at the factory and should require no adjustment. Consult your International Harvester dealer if the governor does not function properly.

Ignition Switch Button

This button closes and opens the electrical circuit for operating and stopping the engine. Pull the button out for operating and push it in to stop the engine.

Caution! On tractors with battery ignition, when the engine is not operating or the engine has stalled and the operator leaves the tractor, the ignition switch button must be pushed all the way in, so that the switch is in the off position, to prevent battery discharge.

Starting Switch Control Rod

To start the engine, adjust the choke rod and pull out on the starting switch control rod as explained on page 11.

Belt Pulley and Power Take-Off Shifter Levers

The shifter lever is used to engage and disengage either the belt pulley or the power take-off. See pages 30 to 32 for operating instructions.

Oil Pressure Indicator

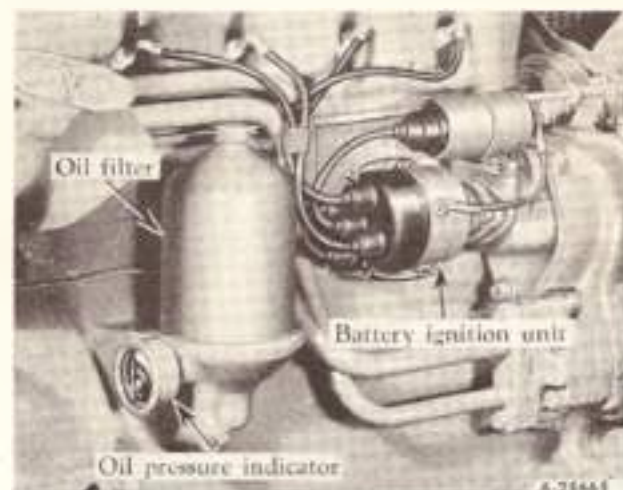

Illustr. 5A

Location of the oil pressure indicator.

This indicator (*Illustr. 5A*) shows whether lubricating oil is circulating through the engine. The indicator needle should be in the white area (*Illustr. 5B*) when the engine is running at speeds approximately 100 r.p.m. above slow idle speed. If it is not in the white area, stop the engine immediately and investigate the cause of the oil pressure failure. If you are unable to find the cause, be sure to consult your International Harvester dealer before operating the engine.



A-18539A

Illustr. 5B

Oil pressure indicator, showing the needle in the correct operating position.

Lighting Switch

The switch has three positions: "D"—dim lights, "B"—bright lights, and "O"—off.

Ammeter

This instrument indicates the charging rate of the generator or the discharge rate of the battery. If it shows discharge continuously, investigate the cause to avoid completely discharging the battery and possible damage to the generator. See pages 58 to 65 for additional information on electrical equipment.

DESCRIPTION

Gearshift Lever

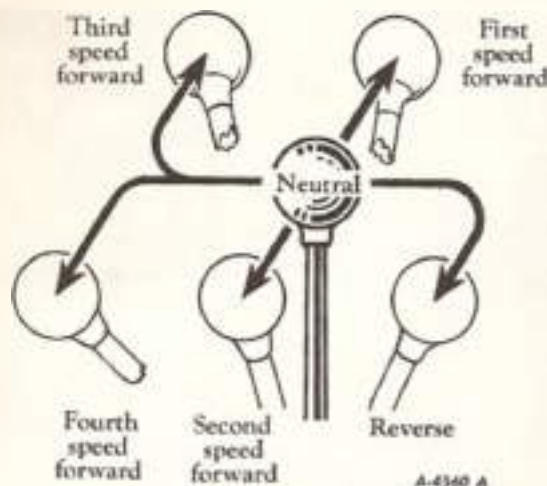

Illust. 6
Gearshift positions.

This lever is used to select the various gear ratios in the transmission. There are four forward speeds and one reverse speed. See *Illust. 6*.

Radiator Shutter Control Lever

The control lever opens and closes the radiator shutter, controlling the engine temperature. Pull the lever all the way back to close the shutter and move the lever forward to open the shutter. Note: Tractors with gasoline engines are not regularly equipped with this feature.

Hydraulic Remote Control Lever

This lever (*Illust. 9*) is used to control the flow of fluid in the cylinder and thus raise or lower the implements the desired amount, within the limits of the system. See pages 19 to 27 for information.

Heat Indicator for Cooling System

This instrument (*Illust. 4*) indicates when the liquid in the cooling system is at the proper temperature for best engine operation. The indicator pointer should be in the center of the "RUN" range (*Illust. 6A*) for engines using distillate or kerosene for fuel, and on the low side of the "RUN" range for engines using gasoline for fuel.



Illust. 6A

Heat indicator, showing the pointer in the correct operating position when operating on distillate or kerosene.

Touch-Control Levers

These levers (*Illust. 4*) operate the Farmall Touch-Control system. This system raises, lowers, and regulates the working depth of the various implements used with the tractor. For complete instructions, see pages 18 and 19.

Heat Indicator for Touch-Control System



Illust. 6B

Touch-Control Fluid heat indicator.

This indicator (*Illust. 4*) registers the temperature of the fluid in the Touch-Control system. When the Touch-Control system is operating, the indicator pointer should be in the "RUN" range approximately in the position shown in *Illust. 6B*. If the pointer moves into the "HOT" area, it is an indication that the system has been operating continuously at high pressure. If this condition occurs, stop the engine immediately and investigate the cause. If you are unable to find the cause, consult your International Harvester dealer before operating the engine. See page 19 for operating instructions.

Manifold Heat Control Lever

This control lever (*Illust. 6C*) is used only on distillate or kerosene engines. For normal operation set the lever in the top notch (hot) position. If the distillate or kerosene engine is to be operated on gasoline, set the control lever in the bottom notch (cold) position, and remove the manifold shield. For complete instructions, see pages 14 and 15.



Illust. 6C

Heat control lever set in the hot position (distillate or kerosene engines only)

DESCRIPTION

Before Starting Your New Tractor

Lubrication

Tractors shipped to destinations in the United States of America, Canada and Mexico are filled with oil in all parts before leaving the factory. Engines are filled with a light engine oil. This is for preservative purposes only and is not suitable for regular service. The original oil should be drained from the crankcase and air cleaner and replaced with the required amount of fresh oil of the proper viscosity for the prevailing temperature.

Tractors packed for export have all oil drained from the engine crankcase, air cleaner and all gear cases.

Before starting the engine for the first time, remove the spark plugs and put about one teaspoonful of crankcase oil into each cylinder; replace the spark plugs and crank the engine to distribute the oil over the cylinder walls. This assures positive lubrication of the cylinders and pistons immediately after starting and eliminates the possibility of scoring.

Lubricate the entire tractor, using the "Lubrication Guide."

Check the oil levels of the engine crankcase, air cleaner, transmission, belt pulley housing, and all gear cases to see that they are filled to the correct levels with oil of the proper viscosity for the prevailing temperature. See the "Lubrication Guide" and the "Lubrication Table."

Pneumatic Tires

Before moving the tractor, check the air pressure in the pneumatic tires and inflate or deflate the front tires to 28 pounds and the rear tires to 12 pounds. See the table on page 75 for more complete information.

Engine Cooling System

The cooling system capacity is approximately 15 U.S. quarts.

Be sure the radiator drain (*Illustr. 57*) is closed; then fill the radiator to a level approximately $2\frac{1}{4}$ inches below the top of the filler neck. Filling the radiator to this level will allow for expansion of the coolant under normal operating conditions. Use clean water; soft or rain water is recommended, as it does not contain alkali, which forms scale and eventually clogs the passages.

Fill the radiator slowly. This permits air to escape from the cylinder head and allows the cooling system to be filled to its maximum capacity.

Never start or operate the engine without water or antifreeze in the cooling system except as instructed in "Cold Weather Precautions" on page 43.

For further information see "Cooling System" (page 46). If the tractor is to be operated in freezing temperatures ($+32^{\circ}$ F. or lower) see "Cold Weather Precautions" on pages 43 and 46.

Fuel System

Provision is made in the design of this tractor so that it may be equipped with either a gasoline, distillate, or kerosene-burning engine. Before attempting to use a fuel for which your tractor is not designed, see your International Harvester dealer or the nearest International Harvester Company District Office for full details.

To obtain best results, use the fuel for which the tractor is designed, follow the operating instructions given for that fuel, and observe the following precautions:

Use clean fuel and keep it clean. Store fuel in tanks equipped with hose and nozzle to prevent contamination of the fuel. The use of funnels, cans and drums is not recommended because they are difficult to keep clean.

Distillate fuels should conform to International Harvester Company specifications (see your International Harvester dealer).

On distillate or kerosene-burning tractors, do not open the shut-off valves under the auxiliary tank and the main fuel tank, or even partially open them, at the same time, as this will permit the distillate or kerosene to mix with the gasoline, making the engine hard to start.

During the first 100 hours of operation, mix one pint of light engine oil with every five U.S. gallons of fuel.

Battery-to-Ground Cable

Tractors shipped from the factory with starting and lighting equipment have the battery-to-ground cable (*Illustr. 65*) disconnected and taped. Therefore, before attempting to start the engine, be sure the battery-to-ground cable is connected to the ground.

Instruments and Controls

Thoroughly acquaint yourself with all instruments and controls as described on pages 4 to 6.

DESCRIPTION

Preparing Your Tractor for Each Day's Work

Fuel System



Never refuel tractor while engine is running or extremely hot.



Illustr. 8A
Filling the fuel tank.

Fill the fuel tank (capacity 11 U.S. gallons) preferably at the end of each day's work. This will force out any moisture-laden air and prevent condensation.

Tractors designed for distillate or kerosene operation have an auxiliary tank (capacity $\frac{1}{2}$ U.S. gallon) for gasoline, which is used only for starting and warming up the engine. If a distillate or kerosene engine is to be operated on gasoline only, use the large fuel tank for gasoline and either shut off the small tank or use it as an auxiliary tank.

The filter caps on both fuel tanks have air vents. These vents should be kept open at all times to assure proper flow of the fuels. See Illustr. 8.

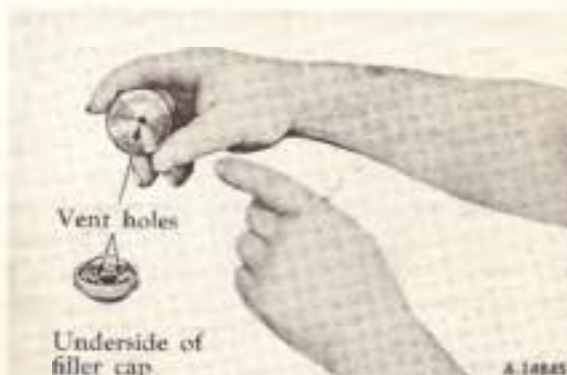

Illustr. 8
Vent holes in the filler cap.

Safety list! Never fill the fuel tank when the engine is running or when near an open flame. Do not smoke or use an oil lantern when working around inflammable fuels. When pouring fuel, keep the hose and nozzle or the funnel and container (if used) in contact with the metal of the fuel tank (Illustr. 8A) to avoid the possibility of an electric spark igniting the gas. Do not light matches near gasoline, as the air within a radius of several feet is mixed with a highly explosive vapor.

Cooling System

Remove the radiator filler cap and check the water level. Fill to a level approximately $2\frac{1}{4}$ inches below the top of the filler neck.

Hydraulic Remote Control System

To prepare the Hydraulic Remote Control system for the first time, follow these instructions:

Connect the break-away coupling rear half to the break-away coupling front half by giving the rear half a light push with a small bar. Because some force is required to latch the coupling, the coupling design provides for use of a small bar to obtain the necessary pressure.

DESCRIPTION

When connecting the break-away coupling front and rear halves, take care to keep the coupling free from dirt and grit. Use the dust caps furnished with the Remote Control to help protect the break-away coupling front half from dirt and damage when the coupling is disconnected.

Note. The Remote Control will lower the implement when the control hand lever is pulled back, provided that the top hose on the control valve is connected to the cylinder on the side of the pivot pin lock pin. It will operate in the reverse manner if the top hose is connected to the opposite side of the cylinder.

Lay the hoses out in a straight line behind the tractor and place the cylinder on a clean, smooth surface.

Remove the filler plug from the Touch-Control reservoir. Start the tractor engine and operate it at a moderate idle speed. Set the stroke limit collar at the yoke end of the piston; then operate the piston to its maximum stroke in both directions about ten times by moving the control lever (*Illustr. 9*) back and forth. This will fill the cylinder and hoses with fluid and remove the air from the system.



Illustr. 9

Operating the Remote Control lever.

Set the piston in the retracted position (all the way in) and add enough clean IH Touch-Control Fluid to the reservoir to bring the level up to within $\frac{1}{2}$ inch of the bottom of the filler opening. Replace and tighten the filler plug.

Attaching the Cylinder

To attach the cylinder to the trailing implement, see the instructions on page 20.

Lubrication

Air Cleaner

Change the oil in the air cleaner oil cup. Fill to the level mark with engine oil. The capacity is $\frac{3}{4}$ U.S. pint.

Engine Crankcase

When operating on gasoline, add sufficient oil to bring the oil up to the level of the upper test cock in the crankcase pan. See *Illustr. 38B*.

When operating on distillate or kerosene: Before starting your engine for the day's work, open the lower test cock in the crankcase pan and allow the oil to drain to this level. Close the lower test cock and open the upper cock in the crankcase pan. Add new oil (approximately one U.S. pint) until it appears at this level and then close the cock. See *Illustr. 38B*.

Lubrication Fittings

See the "Lubrication Guide" for complete daily lubrication requirements.

Periodic Inspections

See pages 42 and 43.

OPERATING YOUR TRACTOR

Before attempting to start or operate the tractor, be sure you review the instructions for the new tractor and thoroughly familiarize yourself with the instruments and controls.

Operating a Gasoline Engine

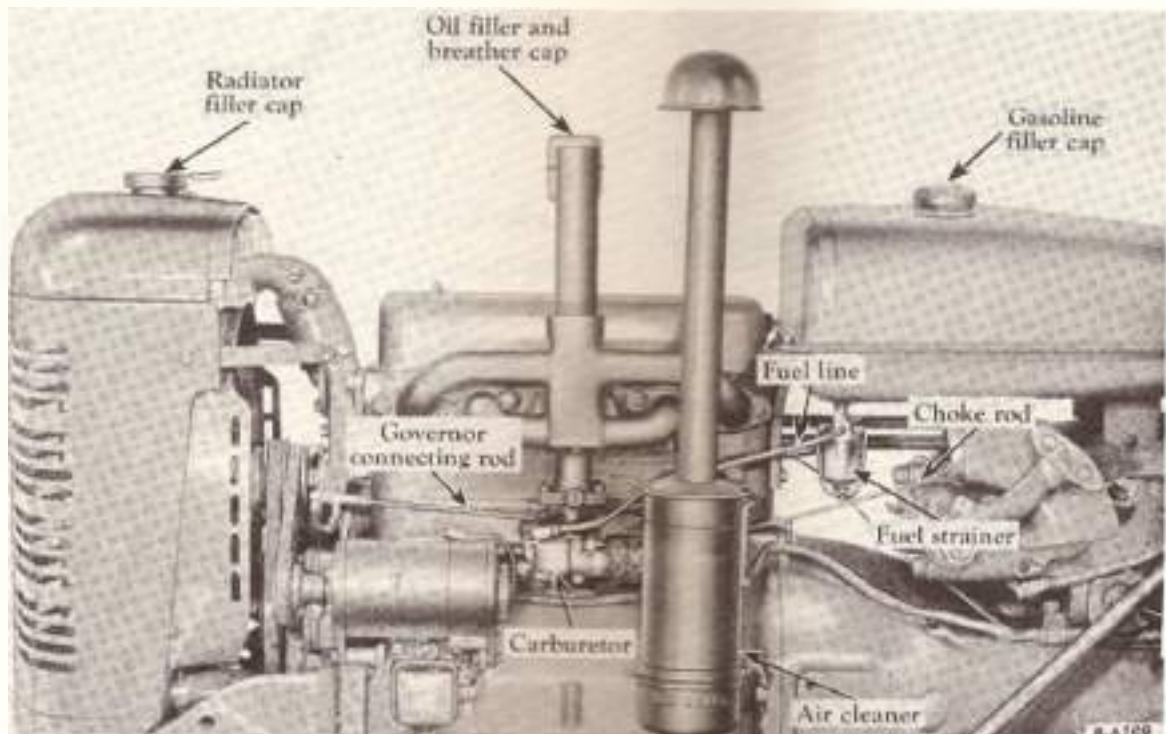

Illustr. 10

Fuel system—gasoline engine.



Loose or "Boggy" clothing should not be worn by the operator because of the danger of it wrapping on or getting into the moving parts.

Radiator Shutter

Tractors designed for gasoline engine operation are not regularly equipped with a radiator shutter but this feature can be supplied. If your tractor is so equipped, close the radiator shutter when starting the engine in cold weather; then regulate it as required to hold the needle of the heat indicator on the low side of the "RUN" range.

Fuel System

Check the gasoline tank to make sure it is full; also be sure the shut-off valve on the fuel strainer under the gasoline tank is open.

To assure against leakage or seepage when the valve is in its full open position, be sure to screw the needle stem (shut-off valve) out until the seat on the stem is tight against the stop.

OPERATING YOUR TRACTOR

Starting the Engine with the Cranking Motor



When starting the engine in a barn or garage, keep the doors wide open as the exhaust gas from internal combustion engines contains poisonous carbon monoxide which is odorless, tasteless and colorless.

1. Put the gearshift lever in the neutral position. See *Illustr. 6*.

2. Pull the choke rod all the way out. See *Illustr. 11*.

When using the choke, avoid overchoking, as excessive use of the choke will flood the engine, making it hard to start. The use of the choke for starting will vary, depending on temperature and altitude.

3. Advance the engine speed control lever one-third. See *Illustr. 5*.

4. Pull the ignition switch button out. See *Illustr. 11A*.



Illustr. 11
Pulling the choke rod out.



Illustr. 11A
Pulling the ignition switch button out.

5. Disengage the engine clutch by pressing down on the clutch pedal. Pull out on the starting switch control rod (*Illustr. 11B*) and release it as soon as the engine starts. However, do not operate the cranking motor for more than thirty seconds at any one time. If the engine does not start within this time, release the starting switch control rod and wait a minute or two, then try again. Slowly release the clutch pedal after the engine starts.



Illustr. 11B
Pulling the starting switch control rod out.

OPERATING YOUR TRACTOR

Hand-Cranking the Gasoline Engine



Be sure the gearshift lever of the tractor is in neutral before starting the engine.

1. Put the gearshift lever in the neutral position. See *Illust. 6*.
2. Pull the choke rod all the way out. See *Illust. 11*.
3. Advance the engine speed control lever one-third. See *Illust. 5*.
4. Pull the ignition switch button out. See *Illust. 11A*.
5. Crank the engine one or two strokes; then push the choke rod halfway in.
6. Crank the engine until it starts. See *Illust. 12*.

Caution! When cranking the engine, be sure the gearshift lever is in the neutral position and always stand in a position that will eliminate any possibility of being struck by the starting crank if there is a reversal of the direction of the engine. Crank the engine by using quick upstrokes; do not spin it.



Illust. 12
Correct method of hand-cranking.

The following instructions offer approximate requirements which may be changed to suit local conditions:

During warm weather, or with the engine warm, pull the choke rod halfway out; then crank the engine, using quick upstrokes until the engine starts.

During cold weather, or with the engine cold, pull the choke rod all the way out and crank the engine with quick upstrokes as follows:

Six to eight lifts of the crank at temperatures 0° to $+10^{\circ}$ F.

Four to five lifts of the crank at temperatures $+10^{\circ}$ to $+20^{\circ}$ F.

Two to three lifts of the crank at temperatures $+20^{\circ}$ to $+30^{\circ}$ F.

Then push the choke rod halfway in and crank the engine with quick upstrokes until it starts.

After the Engine Starts

As soon as the engine starts, adjust the choke to a point where the engine operates without missing and, as the engine warms up, open the choke all the way by gradually pushing the choke rod all the way in. Do not use the choke to enrich the fuel mixture except when starting the engine.

Immediately after the engine starts, check the oil pressure indicator (*Illust. 38*) to make sure lubricating oil is circulating through the engine. The indicator needle should be in the white area when the engine is running at speeds approximately 100 r.p.m. above slow idle speed. If it is not, stop the engine and inspect the oil system to find the cause of failure. If unable to find the cause, consult your International Harvester dealer before operating the engine.

Stopping the Gasoline Engine

Retard the engine speed control lever by pulling it all the way back (*Illust. 5*). Allow the engine to cool slowly from full-load operation by slowly idling the engine for a short time. Then push the ignition switch control button all the way in to stop the engine. It is advisable to close the gasoline shut-off valve if the engine is to be stopped for any length of time.

OPERATING YOUR TRACTOR

Operating a Distillate Engine on Distillate

Follow these four steps when operating a distillate engine on distillate:

1. Set the manifold heat control lever in the top notch (hot) position. See page 14.
2. Start the engine on gasoline.
3. Change over to distillate fuel.
4. Change back to gasoline before stopping the engine, to insure having gasoline in the fuel bowl for the next starting.

The above steps are fully explained in this manual. Study them carefully.

Radiator Shutter

Tractors designed for operation on distillate are regularly equipped with a radiator shutter to assist in warming up a cold engine quickly and to maintain the engine at the most efficient operating temperature. Distillate fuels are heavier than gasoline and therefore require more heat for proper vaporization. Before starting a distillate engine, close the radiator shutter completely.

After the engine has been started, allow it to operate with the radiator shutter closed until the pointer on the heat indicator is in the center of the "RUN" section; then regulate the shutter enough to keep the pointer on the heat indicator in the center of the "RUN" section (Illustr. 6A).

The adjustment of the shutter will vary, depending on the load the tractor is handling, length of idling periods, atmospheric temperatures, and the kind

and quality of fuel that is being used.

Important! Before filling the radiator in freezing weather, close the radiator shutter and start the engine; then put the water in the radiator immediately. This prevents water from freezing during the warming-up period. After the engine has warmed up, adjust the radiator shutter to maintain the operating temperature of the engine in the center of the "RUN" section on the heat indicator (Illustr. 6A).

Fuel System

Check the fuel and auxiliary gasoline tanks to make sure they are full. Open the gasoline valve and be sure the shut-off valve for the main fuel tank is closed (This shut-off valve should not be opened until the engine has been operating on gasoline long enough to be thoroughly warmed up.)

Continued on next page.

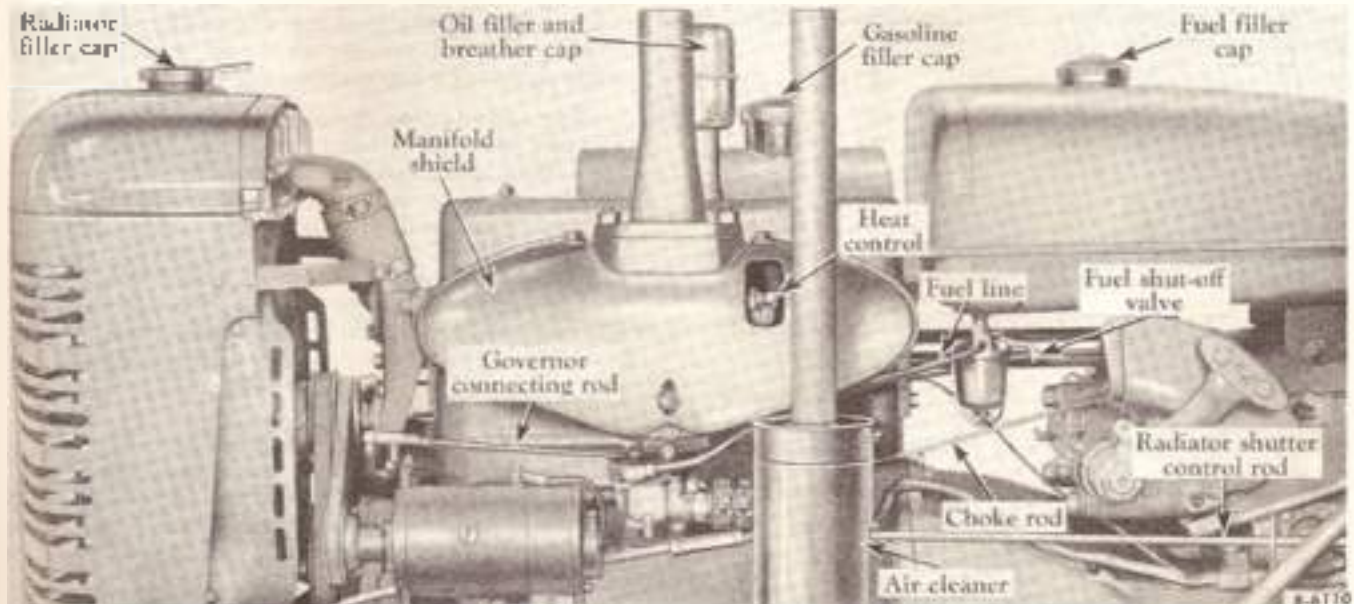

Illustr. 13
Fuel system—distillate engine.

Fuel System—Continued

Do not mix fuels! Do not open the shut-off valve under the auxiliary tank and the one under the main fuel tank at the same time as this will permit the distillate fuel to mix with the gasoline, making the engine hard to start.

Before starting the engine on gasoline, be sure there is no distillate fuel in the carburetor or in the fuel strainer.

Manifold Heat Control

The distillate engine manifold is designed so that the hot exhaust gases pass around the intake manifold and heat the incoming fuel mixture, resulting in maximum efficiency under all normal operating conditions.

The manifold heat control valve has three adjustment positions: (1) top notch (hot) position; (2) center notch (intermediate) position; (3) bottom notch (cold) position. See *Illustr. 6C*.

With these adjustments, the heat of the manifold can be regulated to suit various operating conditions, which are governed by the prevailing air temperature, the load the engine is handling, and the kind and quality of fuel that is being used.

When operating the engine on distillate, the heat control valve should be set in the top notch (hot) position (*Illustr. 6C*). To do this, loosen the nut on the heat control adjusting lever and raise the lever to the top notch. Always keep the valve in this position except when the prevailing temperature is very high or when the engine is operating with a constant heavy load. In such cases, use either the intermediate or cold position.

The manifold should be kept hot at all times to properly vaporize the heavy fuels and to avoid dilution of the crankcase lubricating oil.

Starting the Distillate Engine with the Cranking Motor

1. Put the gearshift lever in the neutral position. See *Illustr. 6*.
2. Open the gasoline shut-off valve under the auxiliary gasoline tank and be sure the shut-off valve for the main fuel tank is closed. See *Illustr. 13*.
3. Advance the engine speed control lever one third. See *Illustr. 5*.
4. Close the radiator shutter.
5. Pull the ignition switch button out. See *Illustr. 17A*.
6. Pull the choke rod all the way out. See *Illustr. 11*.

7. Disengage the engine clutch by pressing down on the clutch pedal. Pull out on the starting switch control rod (*Illustr. 11B*) and release it as soon as the engine starts. However, do not operate the cranking motor for more than thirty seconds at any one time. If the engine does not start within this time, release the starting switch control rod and wait a minute or two; then try again. Slowly release the clutch pedal after the engine starts.

Hand-Cranking the Distillate Engine

1. Put the gearshift lever in the neutral position. See *Illustr. 6*.
2. Open the gasoline shut-off valve under the auxiliary gasoline tank and be sure the shut-off valve for the main fuel tank is closed. See *Illustr. 13*.
3. Advance the engine speed control lever one third. See *Illustr. 5*.
4. Close the radiator shutter.
5. Pull the ignition switch button out. See *Illustr. 17A*.
6. Pull the choke rod all the way out. Crank the engine one or two strokes; then push the choke rod halfway in. Crank the engine until it starts. See *Illustr. 12*.

Avoid overchoking as excessive use of the choke will flood the engine, making it hard to start. For best results follow the procedure outlined on page 12.

After the Engine Starts

As soon as the engine starts, adjust the choke to a point where the engine runs without missing. As the engine warms up, gradually open the choke all the way by slowly pushing the choke rod all the way in. Do not use the choke to enrich the fuel mixture except when starting the engine.

Immediately after the engine starts, check the oil pressure indicator (*Illustr. 3B*) to make sure lubricating oil is circulating through the engine. The indicator needle should be in the white area when the engine is running at speeds approximately 100 r.p.m. above slow idle speed. If it is not, stop the engine and inspect the oil system to find the cause of failure. If unable to find the cause, consult your International Harvester dealer before operating the engine.

Changing Over to Distillate Fuel

When the engine has operated a while and the needle on the heat indicator is well into the "RUN" section, change over to operate on distillate by tightly closing the gasoline shut-off valve and quickly opening the shut-off valve under the main fuel tank.

After the engine has thoroughly warmed up, adjust the radiator shutter so as to maintain the needle on the heat indicator in the center of the "RUN" section. See *Illustr. 6A*.

OPERATING YOUR TRACTOR

Stopping the Distillate Engine

Close the distillate shut-off valve and open the gasoline shut-off valve. Operate the engine two or three minutes with the engine speed control lever one-half advanced to empty the fuel lines and carburetor of distillate and to fill them with gasoline. This will insure having gasoline in the fuel bowl for starting again. Retard the engine speed control lever by pulling it all the way back and push the ignition

switch button all the way in.

After the engine has stopped, it is good practice to close the gasoline shut-off valve.

To start an engine that has been stopped while operating on distillate and has cooled off, close the main fuel shut-off valve and drain the distillate from the carburetor fuel bowl and fuel strainer bowl; then proceed in accordance with the starting instructions shown on page 14.

Operating a Kerosene Engine

If your tractor is equipped with a kerosene-burning engine, follow the same operating instructions as outlined for distillate operation.

If a kerosene engine is to be operated on gasoline, the same instructions as for operating a distillate engine on gasoline will apply.

Operating a Distillate Engine on Gasoline

Distillate or kerosene engines may be operated on gasoline if necessary; however, more satisfactory results will be obtained when the engine is operated on the fuel for which the engine is designed.

To operate a distillate engine on gasoline, follow the same operating instructions as for distillate operation (pages 13 and 14) except as outlined below.

Fuel System

The 11 U.S. gallon fuel tank is used for gasoline and the small tank may be used as an auxiliary tank.

Radiator Shutter

Close the radiator shutter when starting the engine in cold weather, and as the engine warms up, regulate the shutter so the heat indicator pointer maintains its position on the low side of the "RUN" section.

Manifold Heat Control

Set the heat control lever in the cold position except when operating under a light load or in extremely cold weather; then the lever should be set in the intermediate position. See *Illustr. 6C*.

Manifold Shield

Remove the manifold shield except when operating in extremely cold weather.

Stopping the Engine

Retard the engine speed control lever by pulling it all the way back. See *Illustr. 5*. Allow the engine to cool slowly from full-load operation by slowly idling the engine for a short time. Then push the ignition switch button all the way in to stop the engine. It is advisable to close the gasoline shut-off valve if the engine is to be stopped for any length of time.

OPERATING YOUR TRACTOR

Driving the Tractor

Starting the Tractor



ILLUSTRATION 10

Shifting gears before starting the tractor in station.

1. Advance the engine speed control lever slightly. See Illustration 5.
2. Disengage the clutch by pressing the clutch pedal all the way in.
3. Hold the clutch pedal in this position and move the gearshift lever in the desired speed (Illustration 6); then advance the engine speed control lever to a



Always engage the clutch gently, especially when going up a hill or when pulling out of a ditch.



Always lock the brake pedals together when driving on the highway or when driving in high gear.

Be sure the brakes are properly adjusted.

position where the engine operates best for the load to be handled.

4. Start the tractor in motion by slowly releasing the clutch pedal. Note: Do not shift gears while the engine clutch is engaged or while the tractor is in motion.

5. Do not "ride" the clutch or brake pedals by resting the feet on the pedals while driving the tractor because this will result in excessive wear on the linings.

Always latch the brake pedals together before driving the tractor in high gear. To latch the pedals together, engage the latch into the slot in back of the right pedal. See Illustration 18. When the brake pedals are not latched together, the latch should rest in the slot in back of the left brake pedal.



Be extra careful when working on hillsides. Watch out for holes or ditches into which a wheel will fall and overturn the tractor.

OPERATING YOUR TRACTOR



Never dismount from the tractor while it is in motion. Wait until it stops.



Always keep the tractor in gear when going down steep hills.

Steering the Tractor

The tractor is steered in the conventional manner by means of the steering wheel; however, to make a sharp or pivot turn, press the right or left brake pedal, depending on the direction in which the turn is to be made. The brake pedals must be unlatched so they can be operated individually.

Towing the Tractor

When towing is necessary, use a tow rope or cable and have an operator steer the tractor and operate the brakes.

Attach a tow rope or cable at the implement mounting bolt holes on the side of the steering gear housing. In no case should the attachment be made to the lower holster. When towing a tractor, do not exceed a speed of 20 m.p.h.



Reduce speed before making a turn or when applying the brakes. Remember, the danger of the tractor overturning increases four times when the speed is doubled.



If the tractor will not move because the rear wheels have dug in or sunk deeply into the ground, don't fasten logs, posts, or anything to the rear wheels that will prevent them from rotating. This would be certain to tip the tractor over backward. Instead,



... dig out or jack up the rear wheels and fill in under them. Or, if another tractor is available, hitch it with a chain to the front end of the "stuck" tractor at the implement mounting bolt holes on the side of the steering gear housing. The power of both tractors should be used, and a heavy pull must be kept on the chain all the time.

OPERATING YOUR TRACTOR



Always drive the tractor at speeds slow enough to insure safety, especially when driving over rough ground or near ditches.

Stopping the Tractor

Disengage the clutch by pressing down firmly on the clutch pedal and move the gearshift lever to the neutral position. Use the brakes if necessary.

Locking the Brakes

Always lock the brakes when tractor is parked on a grade or when doing belt work. To lock the

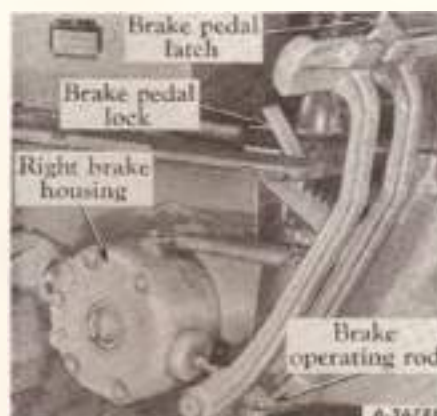

Illustr. 18

Brake pedals in the locked position.

brakes, first latch the brake pedals together with the latch as previously described. Then press down on the brake pedals, lift up the brake pedal lock and let it fall forward. See *Illustr. 18*. The lock will then engage with the ratchet on the left brake pedal. The brake pedals will lock in this position. To release the brakes, simply press the brake pedals further down, lift the lock, and let it fall back into the disengaged position.

Operating the Farmall Touch-Control System

The Farmall Touch-Control system provides hydraulic power with convenient fingertip control for raising, lowering and adjusting the working depth of the various implements used with this tractor. Implements can be regulated and adjusted without stopping work while the tractor is in motion or while standing still.

Touch-Control Levers and Stops

Two control levers are provided to give the operator complete, instantaneous and effortless control of all direct-connected implement operating adjustments. These levers can be used separately or both at the same time. The use of these levers will depend on the type of implement mounted on or pulled by the tractor. Complete instructions for operating the control levers are included in the Operator's Manual furnished with the implement. General instructions for operating these levers are given below.

Each control lever quadrant is provided with a pair of adjustable Touch-Control lever stops. See *Illustr. 19*.

The front stops, when set in a given position, will



Illustr. 18A

Touch-Control levers and heat indicator.

limit the travel of the control levers and prevent the implement from being raised above the desired height.

The rear stops are used to point out the position where the control levers should be each time the implement is lowered to maintain a uniform working depth.

OPERATING YOUR TRACTOR

Raising and Lowering the Implement

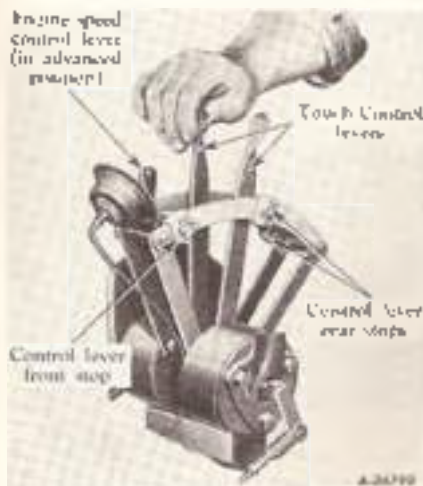

Illust. 19

Operating the Farmall Touch-Control system

To lower the implement, move the control lever back until the implement has reached the desired working depth; then move the rear stop to this position and tighten it in place.

The working depth will be maintained by moving the lever back to the stop each time the implement is lowered.

After attaching the implement to the tractor, the Touch-Control lever from stop must first be properly set if there is a possibility of the implement not clearing the underside of the tractor. Once the stop is set, the implement can be raised quickly by a forward kick of the control lever.

To set the Touch-Control lever from stop, slowly move the control lever forward to raise the imple-

ment and stop it before the implement strikes any part of the underside of the tractor. Then move the stop up against the control lever and tighten it in this position. This will prevent the control lever from being moved beyond the point of the desired lifting height.

Touch-Control Heat Indicator

When the Touch-Control system is operating efficiently, the pointer on the heat indicator should be in the "RUN" range approximately in the position shown in *Illust. 6B*.

Caution: If the pointer moves into the "HOT" area, it indicates that the system has been operating continually at high pressure. If this condition should occur, stop the engine immediately and investigate the cause. One of the most common reasons for this condition is the striking of the implement on the underside of the tractor.

Operating the Touch-Control system continually at high pressure will cause damage to the pump and seals. If the implement strikes the underside of the tractor, in addition to doing possible damage to the tractor or implement, the Touch-Control system will not have completed its cycle. This will cause the pump unit to operate at maximum high pressure and will heat the fluid excessively, thereby causing possible internal damage to the pump and seals. When this condition is detected, immediately move the control lever back and set the control lever from stop at a point where the raised implement will not strike the underside of the tractor. If you are unable to find the cause, consult your International Harvester dealer before operating the engine.

For additional information, see pages 76 to 78.

Operating the Hydraulic Remote Control System

Remote Control on your tractor gives you the same ease of control with trailing implements that you have with Touch-Control for mounted implements. The Hydraulic Remote Control system consists of three major units: a control valve (with hand lever and connecting linkage), a safety break-away coupling, and a hydraulic cylinder. Hydraulic pressure for the Remote Control system is provided by the regular Farmall Touch-Control pump.

A Hydraulic Extension Attachment is available for the Farmall Super C, equipped with Fast-Hitch. See page 26.

Remote Control and Touch-Control Operation

With your tractor equipped with both Touch-

Control and Remote Control, you can select instantly between control of mounted implements or control of trailing implements without having to disengage either control. When using a trailing implement, you merely operate the control lever when using a mounted implement, you simply operate the Touch-Control hand levers. In either case, both types of control operate without interference from the other.

When the application demands, both Touch-Control and Remote Control can be operated at the same time. The Touch-Control pump will keep both systems ready for operation. When all hand levers are moved at the same time, the system requiring least pressures operates first.

OPERATING YOUR TRACTOR

Break-Away Hose Coupling



Illustr. 80

The break-away coupling lets the tractor break free without damage to the hoses if an obstruction trips the safety hitch of the implement.

A safety coupling connects the hoses on the tractor with those on the implement. This coupling opens automatically with only a 60-pound tug—a small fraction of the strength of the hoses. It lets an implement break free without damage to hoses if an obstruction trips the safety hitch on the implement. The coupling also opens when a latch is tripped with the fingers. See *Illustr. 20A*. You can disconnect the hoses instantly at the end of a day's work by pressing back on the break-away frame latch and pulling back on the hoses.

When a coupling opens, tight-fitting, spring-loaded valves prevent loss of fluid from the system and also keep out dust and water. The coupling is quickly reconnected, when there is no pressure in the system, by pushing the two couplings together with the hands. When the system is under pressure, a small bar will snap the coupling together. See *Illustr. 20A*.

Attaching the Cylinder

Before operating the Hydraulic Remote Control



Illustr. 20A

Connecting the break-away coupling.

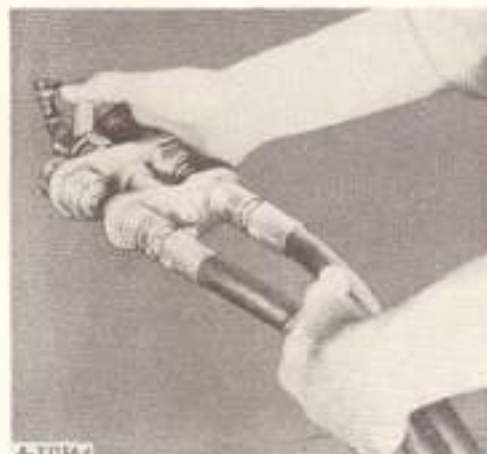

Illustr. 20B

Disconnecting the break-away coupling.

system, attach the cylinder to the trailing implement and adjust the system.

Move the control lever backward or forward until the desired working depth is reached. Then loosen the thumbscrew on the stroke limit collar and set the collar on the piston rod (*Illustr. 20C*) at the position which will allow the implement to reach the desired working depth. The same depth will then be maintained each time the implement is lowered.

Adjusting the Working Depth



Illustr. 20C

Adjusting the working depth by setting the stroke limit collar.

The length of the cylinder piston stroke gauges the working position of the implement. If you want to plow six inches deep, for example, set the collar on the piston rod to give the length of stroke that corresponds to a six-inch depth. The plow will automatically stop at this depth when the collar comes against the limit stop valve in the cylinder. A light push from the collar is ample to close this valve. When the valve closes, oil circulation to the cylinder is stopped, thus halting piston travel. See *Illustr. 21*. This valve eliminates need for heavy collars, yokes and other cumbersome depth-adjusting mechanisms used on some types of cylinders.

OPERATING YOUR TRACTOR

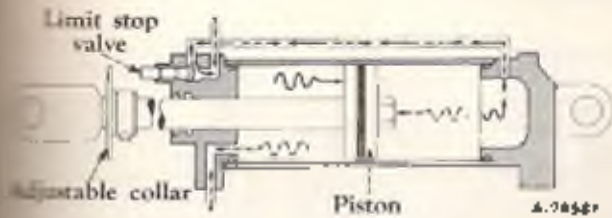

Illustr. 21

When the quick-adjustable stop limit collar strikes the stop valve, the flow of oil is shut off, stopping the piston travel.

No tools are needed to adjust the position of the collar.

Raising and Lowering the Implement

To raise the implement, move the control lever (Illustr. 21A) all the way forward. Hold it at this position until the desired height is reached; then let go and allow the lever to return to the neutral position.

To lower the implement, pull the control lever all the way back until the desired working depth is reached; then let go and allow the lever to return to the neutral position.

To partially raise the implement when it is desirable to ease the load (as when hitching implements, or in cultivating through wet places), move the control lever slowly forward, just enough to secure the desired lift.

Note: The Remote Control will operate as described above if the top hose on the control valve is connected to the cylinder on the side with the pivot

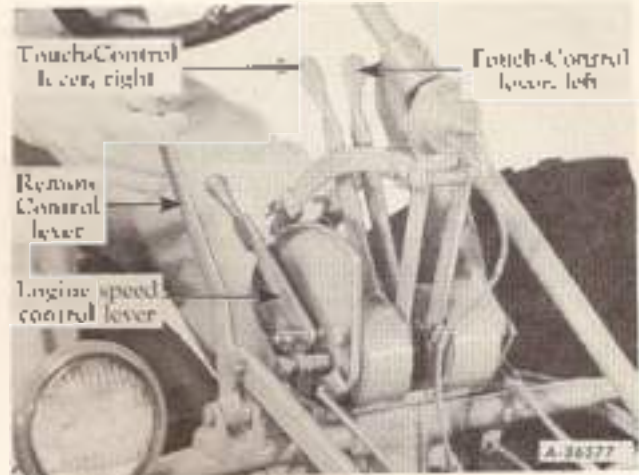

Illustr. 21A

A convenient lever operates the control valve which directs pressure to the hydraulic cylinder.

pin lock pin. It will operate in the reverse manner if the top hose is connected to the opposite side of the cylinder.

To hold the implement in a raised position when the cylinder is removed, use the locking pin furnished with the implement.

To transport the implement, set the stroke limit collar against the valve in the end of the cylinder. This prevents oil circulation and thus locks the implement rigidly in position.

Operating the Fast-Hitch System

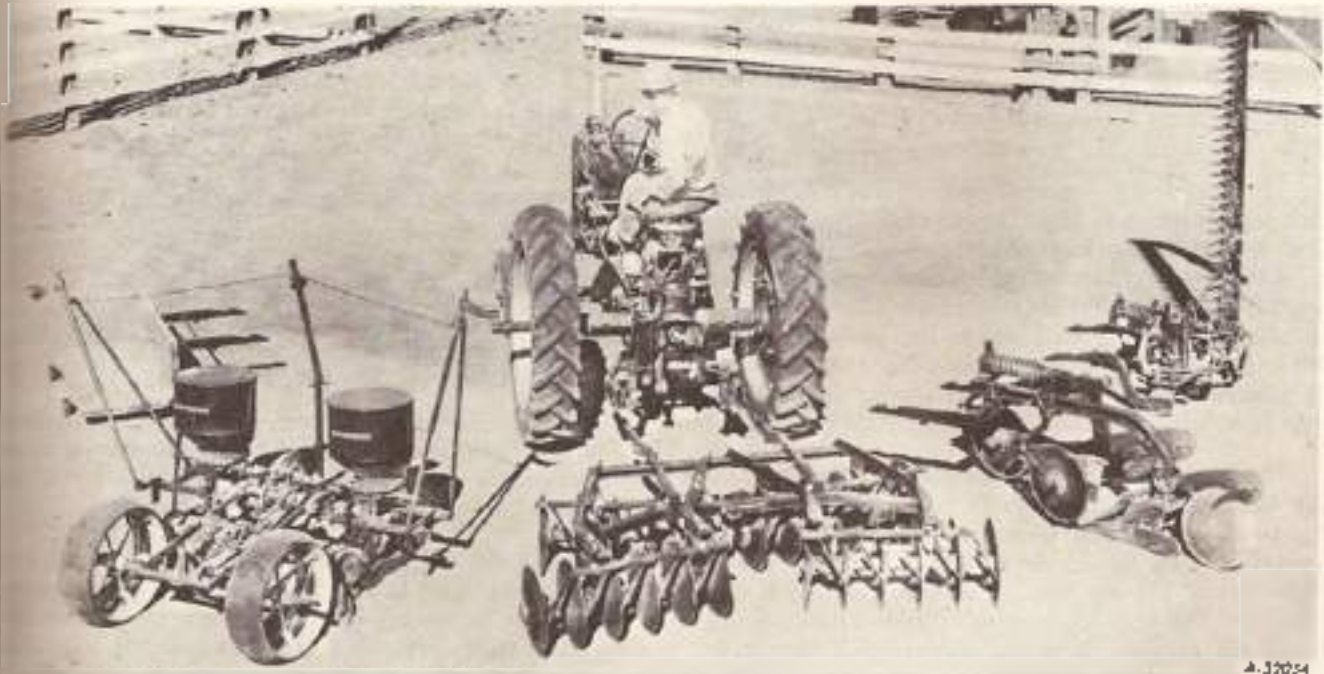

Illustr. 21B

View showing the operator aligning the Fast-Hitch with the implement hitching beams on a lander disk harrow. Several other Fast-Hitch implements are also shown.

General

This hitch provides a simplified means of attaching rear-mounted implements and also adds to the flexibility afforded by the combination of Touch-Control and Hydraulic Remote Control.

Coupling, uncoupling, depth control, and leveling of implements all can be done from the tractor seat. Other adjustments, as outlined on the following pages, are available to the operator.

The Remote Control cylinder raises and lowers the complete hitch, thus raising the implement to the transport position, or lowering it to the working position.

Caution When operating the hitch in other than the fixed drawbar position, both the belt pulley and the power take-off quick attachable safety shield must be removed to prevent these parts from being damaged or broken when the hitch is raised. The belt pulley shaft must be covered with the belt pulley spacer and shaft guard, and the power take-off shaft must be covered with the power take-off shaft guard if not already so protected.

Note: The following operating and adjusting instructions are general only. See the implement Operator's Manual for specific instructions.

Control Levers Used with Fast-Hitch

Three hydraulic control levers serve to control, independently, leveling, depth adjusting, raising, and lowering the implements. The two Touch-Control levers (*Illustr. 21A*), located on the steering shaft brackets directly in front of the operator, serve to control leveling and depth for plowing. The left lever controls leveling for plowing when opening up a furrow or for a change in plowing depth. The right lever serves for depth control.

The Remote Control cylinder is controlled by the control lever (*Illustr. 21A*) located on the headlight support pipe in front and to the right of the operator. This lever is used to raise and lower implements. Do not attempt to gauge the depth with this lever. The implement must be free to float up and down for proper operation. Always pull this lever to the rear as far as it will go when lowering the implement. The lever must be held in the hand until the cylinder is completely retracted; then release it.

Coupling the Implement

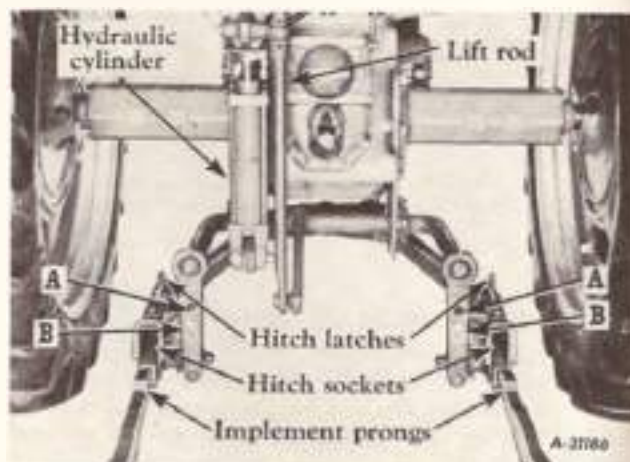

Illustr. 22

Coupling the implement to the tractor.

Coupling implements to tractors with Fast-Hitch is relatively simple but it requires a little thought and practice to do the job quickly without loss of motion. New hitches and implements often need to be "broken in" to work best. Easier action is obtained when the point wears away. Liberally smear the inside of new hitch sockets with pressure-gun grease (chassis lubricant). Make certain the use of the hydraulic control levers is understood. Spend a little time observing the action of the hitch when it is moved by the hydraulic controls.

Set the control lever as required to locate the hitch sockets at the same height as the implement prongs. See *Illustr. 22, 23, and 23A*.

The implement and tractor should rest on reasonably level ground.

For plows: Set the left Touch-Control lever at the front of the quadrant. This levels the hitch the same as the prongs when the plow is resting on level ground.

For implements requiring hitch height adjustment: Set the right Touch-Control lever in the center of the quadrant for plows. Set the lever near the top of the quadrant when used for middlebusters.

Back the tractor until the prongs begin to enter the sockets, and lower the hitch until the weight of the hitch is resting on the prongs; then, with the tractor engine running at approximately one-third throttle opening, back the tractor with a sudden motion so the prongs are forced into the sockets and the latches fall in place.

OPERATING YOUR TRACTOR

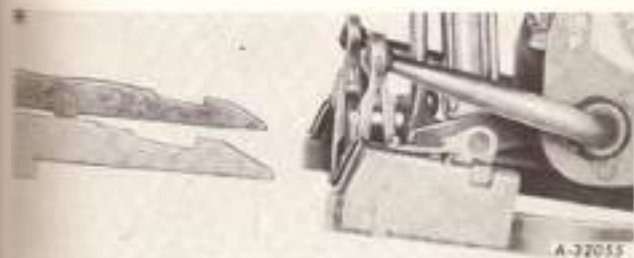

Illustr. 23

Side view showing proper hitch alignment.

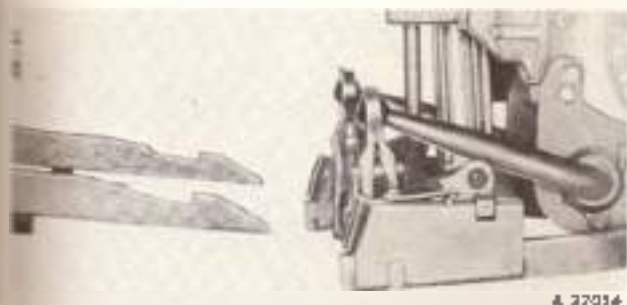

Illustr. 23A

Side view showing improper hitch alignment.

When difficulty in making the connection is experienced and the prongs enter the sockets but not far enough for the latches to fall—the implement may be picked up by the hitch and then set back on the ground. When this is done, the implement will then rest in a better position for lining up.

The above method of coupling will necessarily



Illustr. 23C

View from the tractor seat, showing improper hitch alignment.

be modified for some implements. Variations, such as a difference in tractor tire sizes or the type of tool equipment used, must be considered. Carefully study *Illustr. 23, 23A, 23B, and 23C* to learn the correct procedure for any case.

Uncoupling the Implement

To uncouple the implement, lift the hitch latches with the hook furnished. If the latches are difficult to disengage, back the tractor slightly against the implement to relieve the strain on the latches. The latches (*Illustr. 22*) will remain open until the implement prongs are withdrawn.

Hitch Adjustments

For proper operation when plowing, place the quick-attachable pins in upper storage holes "A" (*Illustr. 22*) in the lateral links. The hitch yoke will then be free to swing from side to side.

Place pins "B" in the lower storage holes to restrain the hitch yoke from swinging when using middlebusters and cultivator rear sections.

Plows operating with one tractor wheel in the furrow require a leveling adjustment which depends on the plowing depth.

To permit leveling control for plows, connect one end of the leveling link (*Illustr. 24*) to the Touch-Control inside left arm with the ruckshaft rear clevis pin, and connect the other end to the bellcrank with a quick-attachable pin.



Illustr. 23B

View from the tractor seat, showing proper hitch alignment.

Continued on next page.

OPERATING YOUR TRACTOR

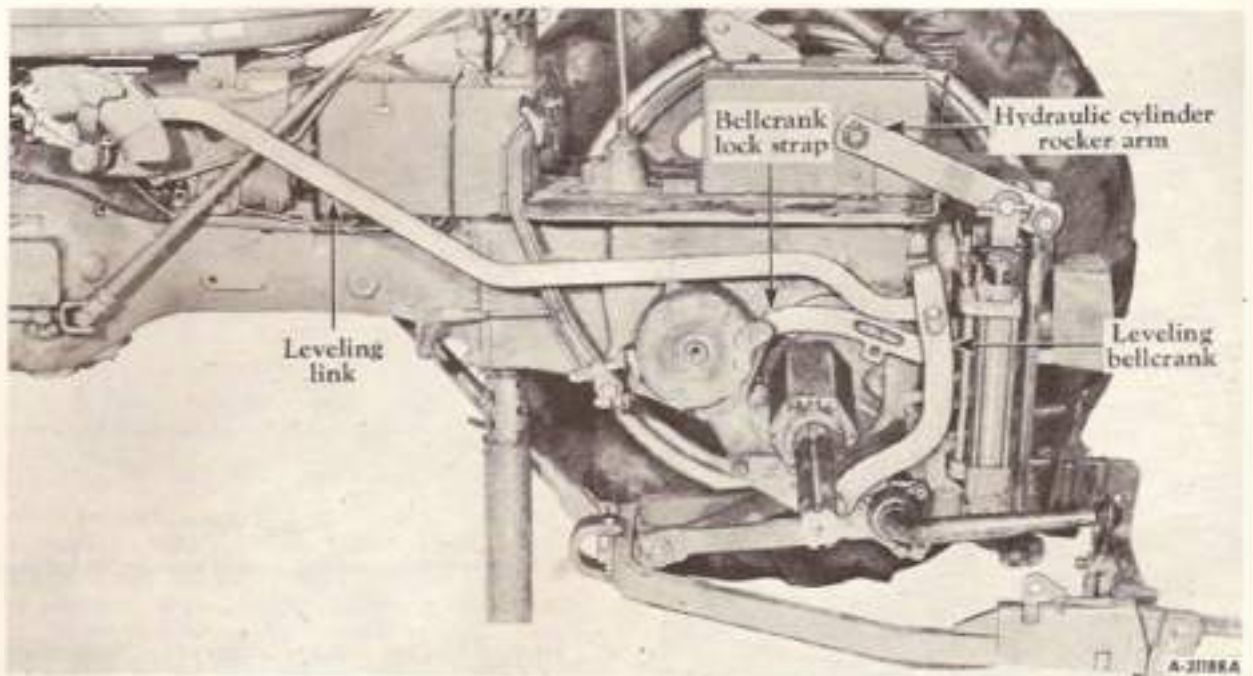

Illust. 24
Connecting the leveling link.

Hitch Adjustments—Continued

For implements such as middlebushers, planters, and rear-mounted cultivators controlled by gauge wheels, remove the leveling link.

Place a quick-attachable pin through the leveling bellcrank and slot in the lock strap as shown at "D" in *Illust. 24A*. This allows the implement to float through a limited range to follow the contour of the ground as determined by the gauge wheels.

Note that in this case the implement will be slightly off level when raised for transporting.

To keep the center line of the hitch rockshaft level with the tractor rear axle (such as for a cultivator rear section not equipped with gauge wheels), place the pin through the bellcrank and the hole in the lock strap as shown at "E" in *Illust. 25*.



Illust. 24A
Quick-attachable pin in position for implements with gauge wheels.

OPERATING YOUR TRACTOR



Illust. 25

Quick-attachable pin in position for implements without gauge wheels.

To regulate the working depth of tillage implements such as plows, the depth-adjusting link must be extended and connected to the Touch-Control rockshaft right arm with clevis pin "F" (Illust. 25A). Pointed pin "G" must be in place to provide a rigid down pressure. Secure both pins in place with quick-attachable cover pins.

The working depth of implements other than plows is gauged from the tractor or by gauge wheels. Penetration is gauged by pitch and down pressure.

For such implements, telescope the depth adjusting link, replace the pointed pin through the sleeve, and connect the sleeve to stud "H" (Illust. 25B) on



Illust. 25A

Position of the depth-adjusting link for implements without gauge wheels.

the side of the tractor clutch housing. Secure with a quick-attachable cover pin.

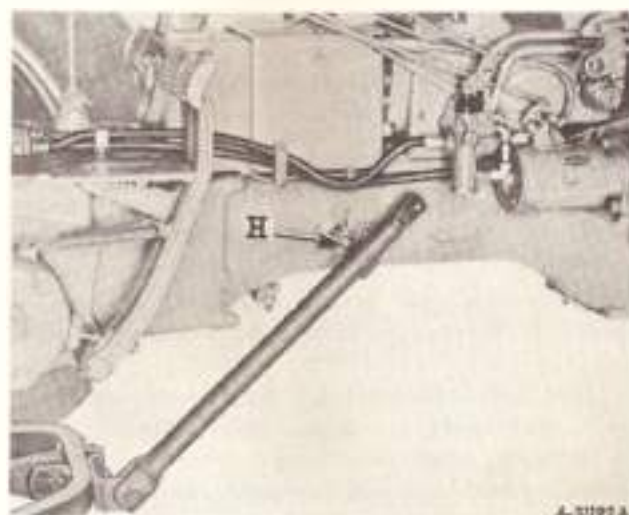

Illust. 25B

Position of the depth-adjusting link for implements with gauge wheels.

OPERATING YOUR TRACTOR

Hydraulic Extension Attachment for Trailing Implements



Illust 26

Fast-Hitch Hydraulic Extension Attachment assembled for trailing implements.

You also can use the rear-mounted, double-acting cylinder of Farmall Fast-Hitch to control trailing implements. A Hydraulic Extension Attachment is available to allow you to interchange the cylinder between Fast-Hitch and your trailing implement quickly. No tools are needed; no oil is lost.

The cylinder is readily installed on any implement having cylinder mounting brackets (Illust. 26) that conform to standardized dimensions. An adjustable collar on the piston rod can be set to precisely regulate the implement working position.

The Hydraulic Extension Attachment, consisting principally of six hoses, two self-sealing couplings, a hydraulic break-away coupling and bracket, six reducing bushings, and a cylinder replacement link, when installed as instructed, permits Remote Control operation of trailing implements.

To change back to Fast-Hitch implement operation, remove the 61-inch hoses by disconnecting the break-away coupling rear half and the self-sealing couplings. Remove the cylinder replacement link from the tractor; then remove the hydraulic

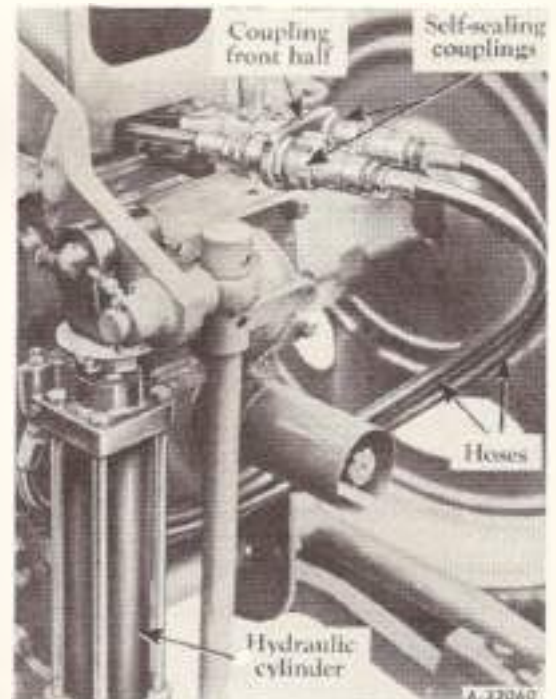

Illust 26A

Hydraulic Extension Attachment changed back to Fast-Hitch implement operation.

cylinder from the trailing implement and install it on the tractor. Connect the self-sealing coupling halves to the break-away coupling front half. See Illust 26A.



Illust 26B

Hydraulic cylinder replaced by cylinder replacement link.

OPERATING YOUR TRACTOR

Fast-Hitch Load Limitations

Caution Do not overload the rear axle or the Fast-Hitch components with implements or accessories. Loads equivalent to those shown below are considered satisfactory:

1. 750-pound disk harrow with a rear tread up to 82 inches.
2. Spring-tooth harrow with a rear tread up to 88 inches.
3. Utility carrier with a 1,000-pound payload, two sets of front wheel weights, and a rear tread up to 76 inches.
4. Utility carrier with a 700-pound payload, and a rear tread up to 80 inches.
5. Utility carrier with a 400-pound payload, and rear tread up to 88 inches.

In general, loads must decrease as tread settings increase, and as distance from the rear axle to the center of gravity of the load increases.

Fast-Hitch Drawbar

Do not attempt to pull any loads other than implements adaptable to the Fast-Hitch system, unless the Fast-Hitch drawbar is in place.

Insert the Fast-Hitch drawbar prongs into the hitch sockets so that the latches snap in place. See *Illustr. 27*.

Remove pin "C" (*Illustr. 27A*) from the hole in the left side of the drawbar and insert it through the sleeve and lift rod at "A". Secure in place with a quick-attachable center pin.

When not in use, replace the pin in the drawbar storage hole to prevent losing or mislaying it. Quick-attachable pins "B" must be in the lower storage holes to prevent the hitch yoke from swinging.

When operating power take-off-driven machines, the drawbar extension plate attachment must be secured to the top and center of the drawbar (*Illustr. 27A*) to provide a standardized power take-off hitch.

When the hydraulic cylinder is used on trailing implements, a cylinder replacement link (*Illustr. 26B*) is used to keep the drawbar at a stationary height.



Illustr. 27
Installing the drawbar.

Three adjustment holes in the link provide stationary drawbar heights of $13\frac{1}{2}$, $16\frac{1}{2}$, and $19\frac{1}{2}$ inches on tractors with 10-36 rear tires.

Insert the $\frac{3}{8}$ x 2 $\frac{3}{16}$ -inch standard pin through the hole in the link selected for the desired drawbar height.

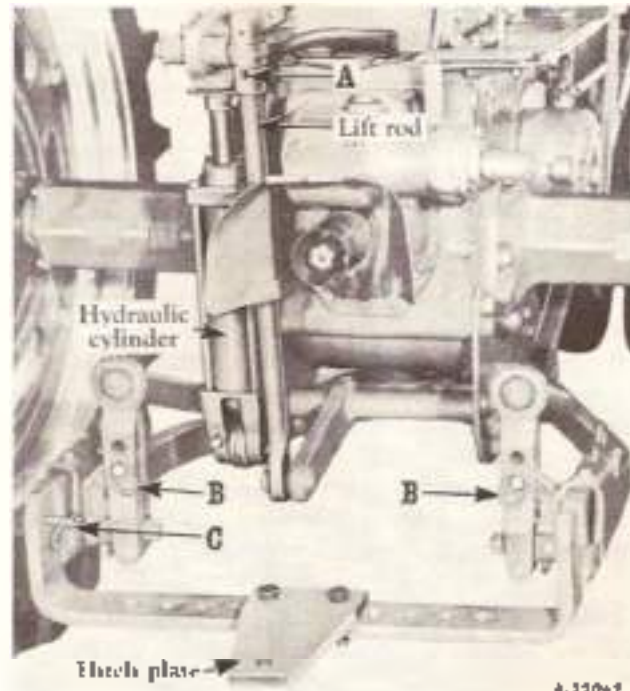

Illustr. 27A
Drawbar and extension plate

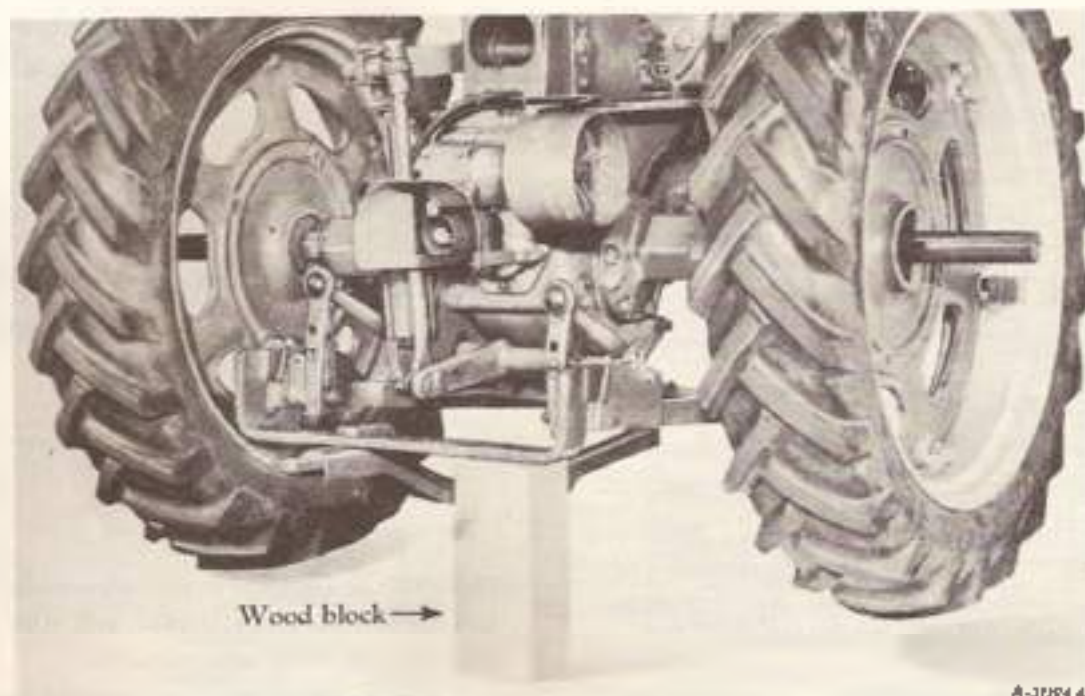

A-37204 4

Illustr. 28

Raising the tractor wheel off the ground.

Raising the Tractor Wheel Off the Ground

The drawbar attachment also can be used as a convenient means of raising the tractor wheels off the ground to remove a wheel or change the rear wheel treads. This can be done by placing a wood block under the drawbar and moving the control lever back so that a down pressure is exerted by the cylinder. See *Illustr. 28*.

Safety first! Be sure the support block is strong and large enough to support the tractor. Also, if a wheel is to be removed from the tractor, place a swing block or jack under the rear axle carrier to prevent the tractor from descending if the control valve should leak or the control lever be accidentally moved, as the holding ability of the check valve is not effective when the tractor is supported in this manner.

Swinging Drawbar

To use the Swinging Drawbar Attachment with

trailing implements (see *Illustr. 26*), place the swinging drawbar guide on top of the drawbar. See *Illustr. 29*. Then attach the front end of the swinging drawbar to the depth adjusting link bracket with the pivot pin and quick-attachable cotter pin.

Use the two $\frac{3}{4}$ N.C. x $1\frac{3}{4}$ -inch cap screws, nuts and lock washers as stops on each side of the swinging drawbar to locate the drawbar in a desired position or to limit the range of the arc. The hole at the rear end of the swinging drawbar is correctly located for power take-off-operated machines.

Caution! Never use the swinging drawbar with power take-off-driven machines without having the stop bolts in the drawbar with one bolt on each side of the swinging drawbar.

When the drawbar is in the extreme lowered position, be cautious when backing up the tractor so as not to allow the swinging drawbar to touch the ground.

OPERATING YOUR TRACTOR

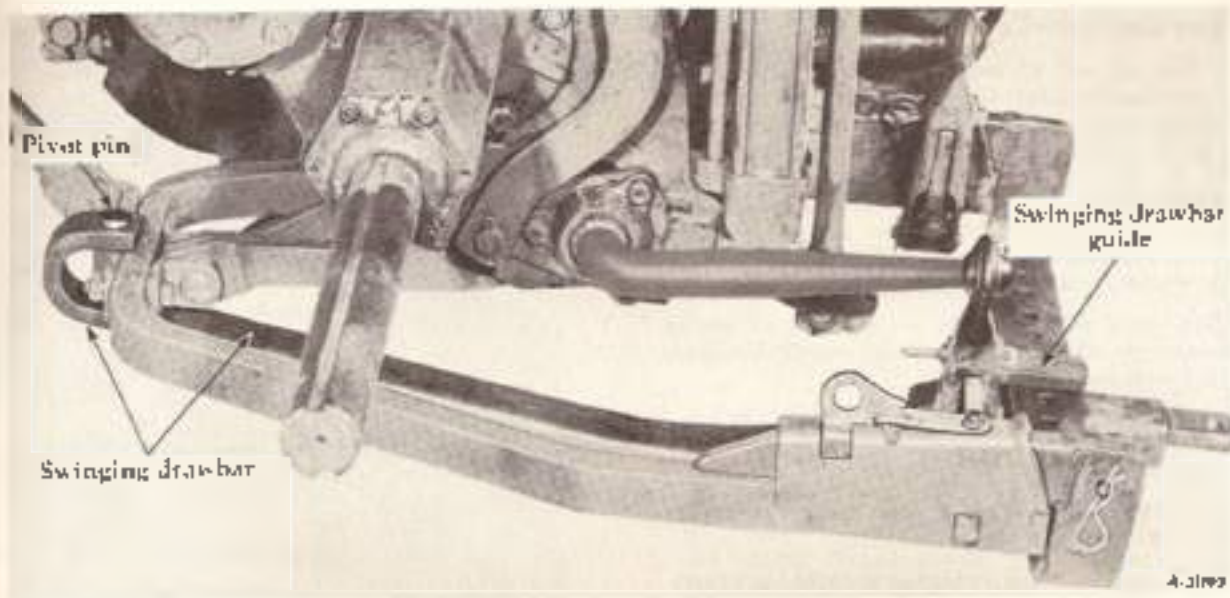

Illustration 99
Attaching the swinging drawbar.

Hitching the Tractor to the Implement (Tractors without Fast-Hitch)

Do not attempt to pull when the drawbar is removed.
Drawbar bolts must be kept tight.
All litches for trailing implements must be attached to the drawbar.

Swinging Drawbar

If your tractor is not equipped with the Fast-Hitch, it is provided with a swinging drawbar. This type of drawbar permits sharper turns when pulling trailing implements and makes tractor operation easier, especially when working in small or irregular fields. The swinging drawbar is free to swing the entire width of the drawbar or, when desired, the

swinging drawbar can be locked in a stationary position.

The tractor exerts its pulling power on pull-behind implements by means of the swinging drawbar which is adjustable up and down to accommodate different hitches. Proper hitching will save both the tractor and the implement it is pulling from undue strains. Make the hitch so that the

Continued on next page



Always hitch to the tractor drawbar, and when pulling a heavy load, pull stumps, rocks, or fence posts, don't take up the slack of the chain with a jerk.



Never stand between the tractor and the drawn implement when hitching.

Swinging Drawbar—Continued

center line of pull of the tractor will fall in line with, or at least be near, the center line of draft of the hitched-on implement. Hitching to one side or the other of the line of draft will cause stresses and strains on the tractor and the implement being pulled, frequently great enough to do permanent damage. Incorrect hitching also tends to make the tractor difficult to steer and will result in unsatisfactory work by the implement being pulled.

When using a long chain to hitch the tractor to the load, drive the tractor forward slowly until all slack is taken out of the chain.

Drawbar Adjustment

The drawbar can be set at four different heights to obtain the proper hitch position.

The hitch bar on the swinging drawbar is adjustable in or out. For ordinary drawbar operations the hitch bar should be in the inner positions, except for standardized power take-off and hitch applications when the hitch bar should be fully extended with the drawbar in the lowest adjustment position (*Illustr. 30*).

Important! When operating with engine-driven machines, such as the No. 64 Harvester-Thresher or the No. 55-T or No. 55-W Balers, the hitch bar should be in the eight-inch position (approximate)

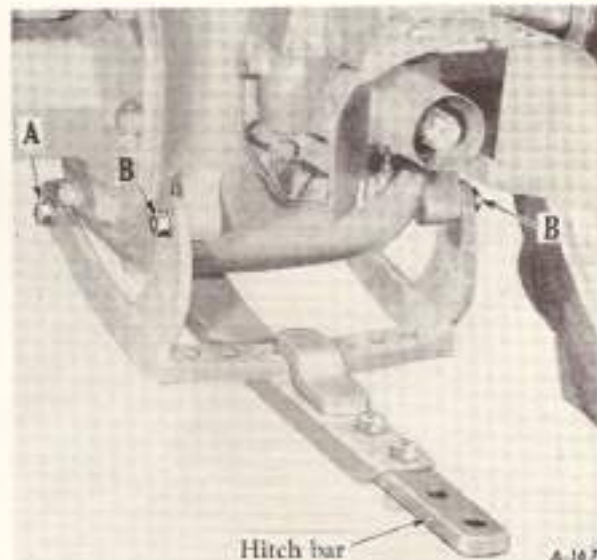

Illustr. 30
Drawbar adjustment.

behind the power take off shaft. At this position three hitch bar holes will be exposed behind a swinging drawbar.

To raise or lower the drawbar, loosen bolts "A" and remove bolts "B" (*Illustr. 30*). Raise or lower the drawbar so that it can be fastened with the upper or lower holes in the drawbar at the upper or lower holes in the transmission case at the position desired. Replace bolts "B" and tighten bolts "A" and "B."



Always ride on the tractor seat when driving on the highway as to and from the field. Never ride on the tractor drawbar or on the drawn implement.



Only one person, the operator, should be permitted to ride on the tractor when it is in operation.

Operating the Power Take-Off

Note: The same shifter lever is used to operate either the belt pulley or power take-off and should always be in the disengaged (forward) position (*Illustr. 31*) when not in use.

The power take-off is started and stopped by the same engine clutch as the tractor. Be sure to disengage the engine clutch before moving the shifter lever.

OPERATING YOUR TRACTOR

Operating the Power Take-Off with the Tractor Standing Still



Illustr. 31

Operating the power take-off.

1. The transmission gearshift lever must be in the neutral position.
2. Move the engine speed control lever back to low idle speed.
3. Depress the clutch pedal to disengage the engine clutch.

4. Move the shifter lever all the way back. See *Illustr. 31*.
5. Slowly release the clutch pedal.

Operating the Power Take-Off with the Tractor in Motion

Follow the first four steps outlined above; then, keeping your foot pressed down on the clutch pedal (in the disengaged position), advance the engine speed control lever and move the transmission gearshift lever to the speed desired to run the tractor. Slowly release the clutch pedal and the tractor will start in motion with the power take-off in operation.

When operating the power take-off, be sure that the master shield (*Illustr. 31*) covering the power take-off exposed shaft is always in place.

When the power take off shaft is not in use, always keep it covered with the power take-off shaft guard.

Be sure to stop the power take-off before dismantling from the tractor.

Power Take-Off Specifications

Power take-off shaft governed speed (maximum) (full load).....	} 539 r.p.m.
Power take-off shaft governed speed (low idle) (no load).....	} 139 r.p.m.
Power take-off shaft governed speed (fast idle) (no load).....	} 593 r.p.m.



Always stop the power take-off before dismantling from the tractor.



When tractor is pulling power equipment, be sure that all power line shielding is in place and in good order.

OPERATING YOUR TRACTOR

Operating the Belt Pulley



Don't put on or remove the belt from the belt pulley while the pulley is in motion.

The belt pulley is started and stopped by the same engine clutch as the tractor. Be sure to disengage the engine clutch before moving the shifter lever. The same shifter lever is used to operate either the belt pulley or power take-off, and should always be in the disengaged (forward) position when not in use.

1. The transmission gearshift lever must be in the neutral position.
2. Move the engine speed control lever back to low idle speed.
3. Depress the clutch pedal to disengage the engine clutch.
4. Move the shifter lever all the way back.
4. Slowly release the clutch pedal.
6. Observe the following instructions when using the tractor belt pulley:
 - a. Secure the implement to receive power in the desired location.
 - b. Align the tractor belt pulley with the imple-

ment pulley. Keep the tractor level if possible.

c. Observe the direction of belt travel indicated on the belt, and install the belt accordingly to prevent damaging it.

d. Tighten the belt enough to prevent the belt from rubbing against itself during operation. Do this by driving the tractor into the belt, locking the brakes, and blocking the tractor rear wheels. (When using a very long belt or a crossed belt, it will not be possible to eliminate all rubbing.)

e. Gradually bring the tractor engine up to speed, making sure the belt is running true.

Note: Static electricity generated by belt work can be discharged harmlessly by attaching a chain to the tractor and letting it touch the ground.

When the belt pulley is not in use, it can be removed and the exposed shaft covered with the spacer and the pulley shaft guard.

If the belt pulley unit is removed for any reason, be sure to have the correct shims in place when reassembling the unit, as the size and number of these shims will change the tooth contact of the gears. See your International Harvester dealer if adjustment for tooth contact becomes necessary.

For additional belt pulley information, see page 91.

Belt Pulley Specifications

Diameter (inches)	Face Width (inches)	Pulley Speed (r.p.m.)	Belt Speed (feet per minute)
8½	6	1,363	3,033
7½	6½	1,563	2,760

*Regularly supplied with Belt Pulley Attachment.

Operating the Pneumatic Tire Pump

Note: A carbureted engine must be used as the source of power.

Remove one of the spark plugs from the tractor engine, or any carbureted engine having the correct spark plug thread size, and replace with pumping element "A". See *Illust. 32*. Attach one end "B" of the pump hose to the pumping element, and other end "C" to the valve stem of the tire to be inflated.

Start the engine and run it at low speed for maximum efficiency.

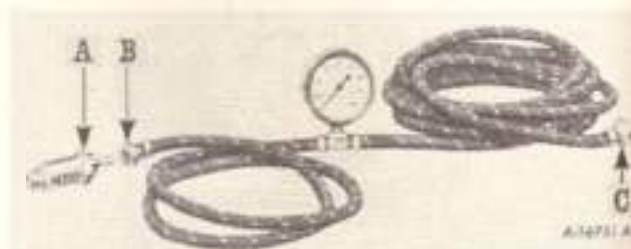

Illust. 32
Engine tire pump with 16-foot hose and air gauge.

LUBRICATION

The life of any tractor depends upon the care it is given. Proper lubrication is a very important part of that care.

General Engine Lubrication



Don't oil or grease the tractor while the engine is running.

The engine has a pressure-feed lubrication system. A gear-type oil pump circulates the lubricating oil under pressure to the crankshaft bearings, connecting rod bearings, camshaft bearings, valve mechanism, timing gears, and governor, thereby assuring positive lubrication of all parts.

The engine is equipped with an oil filter which continually cleans the oil while the engine is running. To obtain the full benefit from the filter, replace the used element with a new one every time the oil is changed in the crankcase (after every 120 hours of operation). Cleaning the old element is not satisfactory.

To pour oil into the engine, remove the breather cap from the oil filler pipe on the valve housing. See *Illustr. 30A*. Test cocks, located on the side of the crankcase pan, indicate the high and low levels of the oil. See *Illustr. 30B*. The oil should never be above the high level nor below the low level.

Never check the oil level while the engine is operating.

Purpose of the Oil Filter

The life of your engine depends upon clean oil being circulated in all bearings. Every good tractor operator knows that dirt and other injurious materials eventually get into the crankcase of the engine and that in the normal course of engine operation the lubricating oil undergoes changes which produce

Oil Pressure Indicator

The oil pressure indicator (*Illustr. 5B*) shows whether lubricating oil is circulating through the engine. This indicator should register in the white area when the engine is running at speeds approximately 100 r.p.m. above low idle speed. If the indicator does not register, stop the engine at once and inspect the oil system to find the cause of failure. If unable to find the cause, consult your International Harvester dealer before operating the engine.

Always check the oil pressure indicator immediately after starting the engine.

Oil Pump

A screen is attached to the oil intake of the gear-type oil pump in the crankcase. It stops large dirt particles from entering the lubricating system. This screen should be cleaned whenever the oil pan is removed. The oil intake floats on top of the oil in the crankcase and draws the oil from the surface, thereby eliminating the possibility of mixing water or sediment with the oil.

Crankcase Breather

The crankcase breather cap, which is also the cap for the oil filler pipe, is located on the top of the valve housing. Remove the breather cap and clean it after every 120 hours of operation; under severe dust conditions, clean more frequently.

To clean, wash the breather cap in kerosene, dip it in engine lubricating oil, and replace after wiping off the excess oil.

Oil Filter

sludge, acids, gums, varnish, and other harmful by-products.

The purpose of the oil filter is to separate and remove the dirt and other foreign substances from the oil to prevent these injurious materials from being circulated to the engine. This filter is so efficient it will keep the circulating oil free of harmful materials for 120 hours of opera-

Continued on next page.

LUBRICATION

Purpose of the Oil Filter—Continued



Illustr. 34
Removing the dirty oil filter element

tion. At this time the crankcase oil should be changed and the inexpensive filter element replaced. See pages 33 and 36 for the recommended oil to use for the prevailing temperature. By following the simple, common-sense procedure for keeping dirt and oil impurities away from precision-made engine parts, you will safeguard your tractor engine against undue wear and the operating troubles and upkeep expense which are a natural result of that condition.

Note. To avoid delays, we recommend that you carry extra filter elements on hand so that replacement can be made at the proper time.

Changing the Filter Element

1. Do not change the element while the engine is running.
2. Remove the oil filter base drain plug (Illustr. 34) and allow the oil filter to drain completely.
3. Clean the filter case to prevent dirt from dropping into the base.
4. Unscrew and remove the retaining bolt.
5. Lift up and remove the case.
6. Remove the old element. See Illustr. 34.

Note: If some special equipment on the tractor prevents lifting the case over the element, remove the case and the element together.

7. Wipe out the base and the case with a cloth dampened with kerosene.

8. Install the new filter element as follows:

- (a) Replace the drain plug in the filter base

and install the new filter element, leaving the retaining band on the element.

- (b) Inspect the small metering hole at the threaded end of the oil filter retaining bolt, and make sure that it is not plugged. A plugged metering hole will impair or stop all oil flow through the oil filter element.
- (c) Make sure that the case gasket is in place and in good condition. Then replace the case and retaining bolt, being careful not to jam the retaining bolt down into the filter seal located inside the filter element. Lower the retaining bolt carefully and screw it through the seal, into the filter base, and tighten securely.

9. Drain and refill the crankcase oil pan with new oil as instructed in the "Lubrication Guide."

10. Start the engine and check the oil pressure indicator to see whether lubricating oil is circulating through the engine; then inspect the filter for oil leaks.

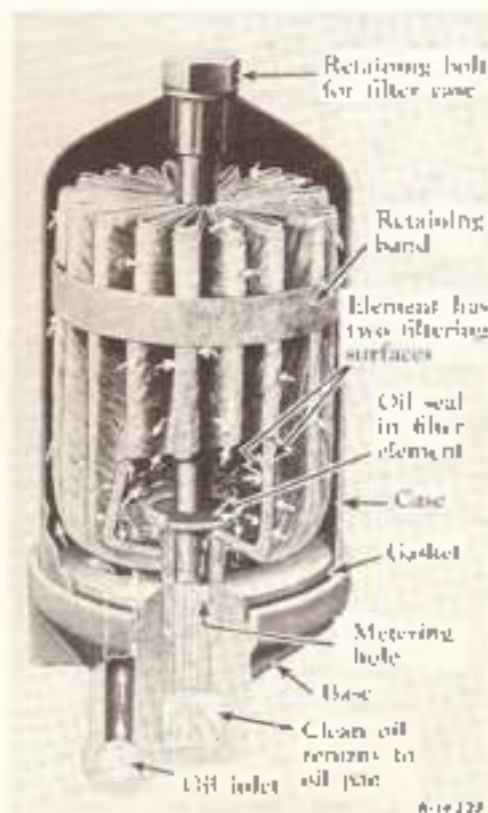

Illustr. 34A
Cutaway view of the oil filter showing passage of oil through the inside and outside surfaces of the umbrella-type filter element.

LUBRICATION

Greasing the Front Wheels

Removing and Greasing

Every six months or after every 500 hours of operation, whichever occurs first, remove, clean and repack the front wheel bearings.

Raise the front end of the tractor until the wheel clears the ground. Remove hub cap "A," the cotter pin, nut "F" and washer "G." Remove bearing "B" and place it in hub cap "A" or in a clean container; then remove the wheel. Clean the inside of hub "H," remove the old grease from the bearings, clean the bearings with kerosene, and repack them with fiber grease.

It is advisable to leave bearing "C" on the axle and clean it with a brush and kerosene. Repack the rollers with new grease before reassembling the bearings.

Inspect the oil seal and felt washer "D," and if they are not in satisfactory condition replace them with new ones. A dirt reflector "E" is also provided on the axle to prevent dirt from entering at the inner bearing.

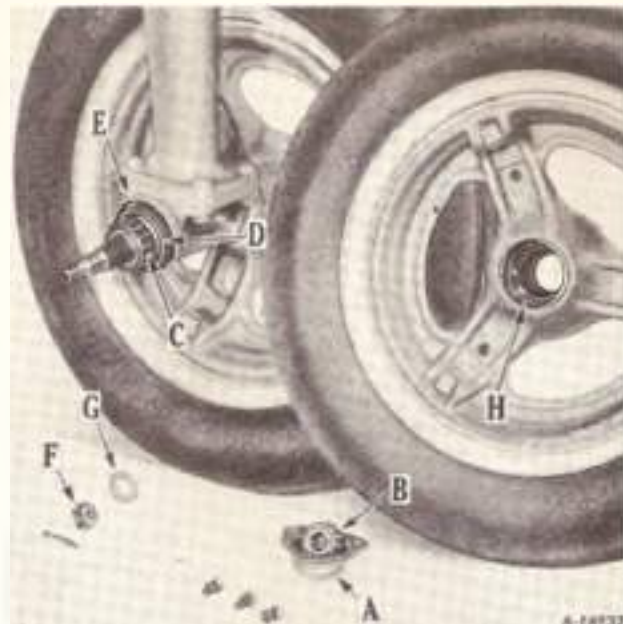

Illustr. 35

Wheel removed for cleaning and greasing

Replacing and Adjusting

Reassemble the wheel and tighten nut "F" until the wheel binds slightly, rotating the wheel at the

same time. Back the nut off one castellation from the cotter pin hole; replace the cotter pin and hub cap.

Be sure to keep all parts clean.

Lubricating Oil and Grease Specifications

Engine Oil

Engine lubricating oil of regular, premium or heavy-duty grade is satisfactory for use in this engine. The oil should be well-refined petroleum oil, free from water, fatty oils and acids.

To Aid Starting

To facilitate starting, the selection of crankcase lubricating oils should be based on the lowest anticipated temperature for the day. It is not necessary to change the crankcase oil every time the temperature rises or falls into another temperature range during some part of the 24-hour day.

Also see "Cold Weather Precautions" on pages 45 and 46 for special instructions.

Gear Lubricant

Tractors shipped from the factory to destinations

in the United States of America, Canada, and Mexico are filled with SAE-80 regular-type lubricant in the transmission, differential and steering gear housing.

Use a good-quality oil, free from solid materials. Use only high-quality lubricating oils and grease. For your own protection, select only oils and grease of recognized manufacture.

Lubrication Fitting Grease

Use pressure-gun grease (chassis lubricant) for lubrication fittings on which the hand lubricator is applied.

Important! Keep your supply of lubricating oil and grease absolutely clean and free from dust. Always use clean containers. Keep the lubricator clean and wipe dirt from the fittings before applying the lubricator.

Lubrication Table

Point of Lubrication	Capacity	Anticipated Air Temperature		
		Above +80°F.	+80°F. to +32°F.	Below +32°F.
Engine crankcase	5 qt.	SAE-30	SAE-20	SAE-10W
Air cleaner oil cup	$\frac{1}{4}$ pt.	SAE-30	SAE-20	SAE-10W
Battery ignition unit Distributor and drive housing	Chassis lubricant	Chassis lubricant	Chassis lubricant
Cam hole felt (in distributor)	Light engine oil	Light engine oil	Light engine oil
Magneto (tractors so equipped)	Light oil*	Light oil*	Light oil*
Generator	SAE-20	SAE-20	SAE-20
Cranking motor	SAE-20	SAE-20	SAE-20
Transmission case without power take-off and belt pulley	$4\frac{3}{4}$ gal.	SAE-80	SAE-80	SAE-80
With power take-off and belt pulley	5 gal.			
Steering gear housing	$1\frac{1}{4}$ pt.	SAE-80	SAE-80	SAE-80
Touch-Control reservoir (refill)	$6\frac{3}{4}$ pt. approx.	IH Touch-Control Fluid	IH Touch-Control Fluid	IH Touch-Control Fluid
Lubrication fittings †	Chassis lubricant	Chassis lubricant	Chassis lubricant

*Magneto distributor bearing and impulse coupling: Use a very light oil, such as cream separator or sewing machine oil, for temperatures above +10° F. Use kerosene in the impulse coupling for temperatures below +10° F. See page 34 for further information.

†Use pressure-gun grease (chassis lubricant) for fittings on which the hand lubricator is applied, for all temperatures.

LUBRICATION

Lubrication Guide

The symbols shown around the reference numbers on the illustration on this page indicate the intervals of lubrication.

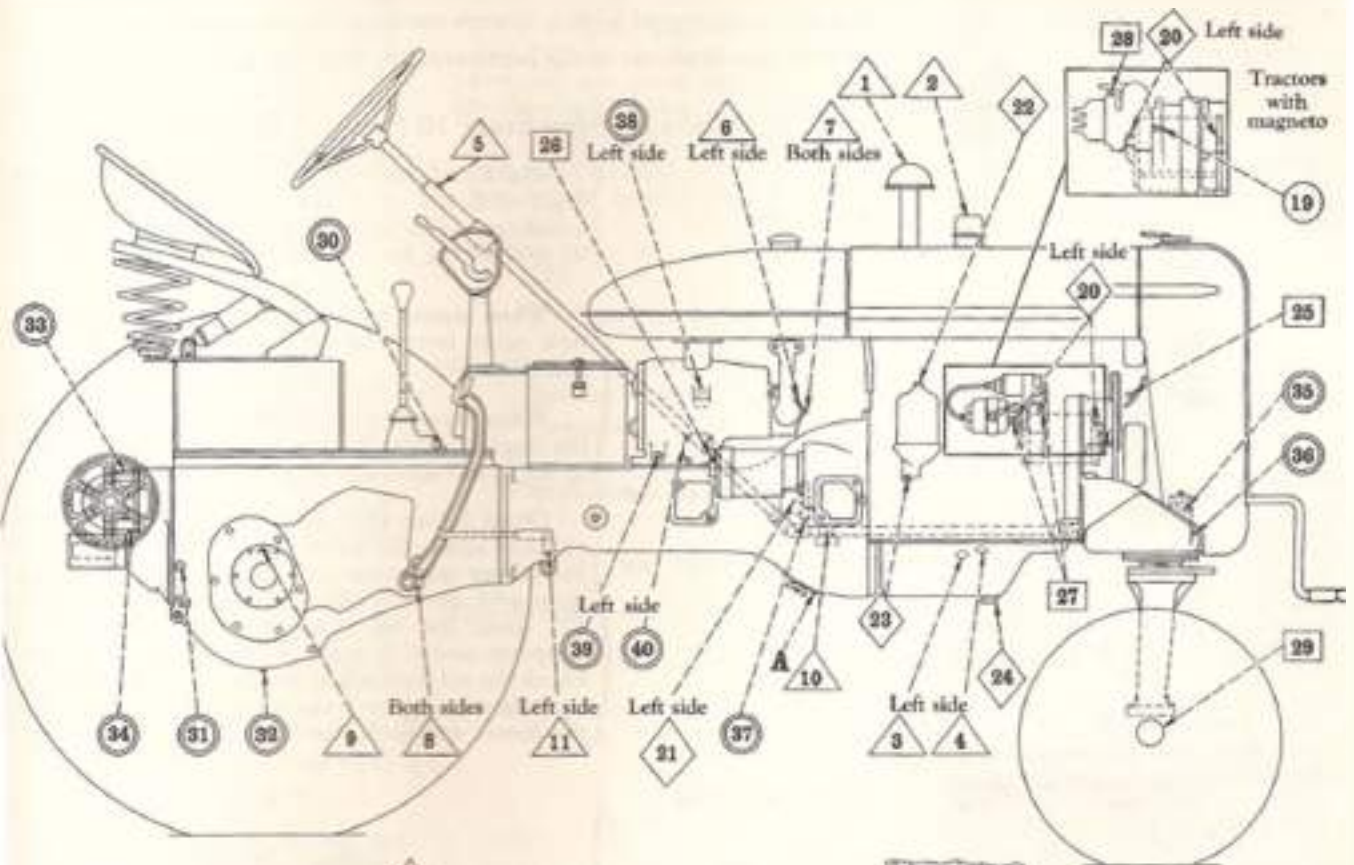

Illustr. 37

8-6077a

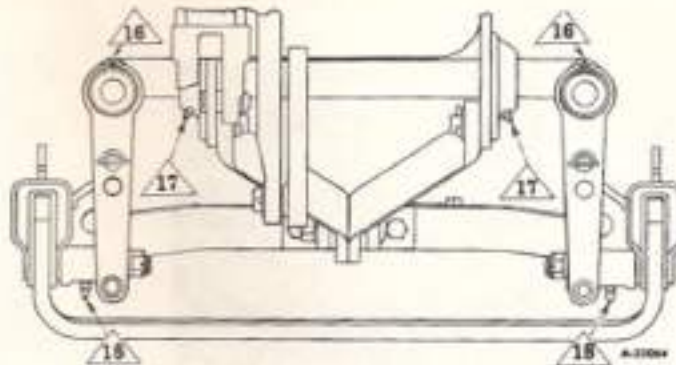

Illustr. 37A
Fast-Hitch Lubrication

LUBRICATION

Key to Lubrication Symbols

The symbols shown around the reference numbers on page 37 indicate intervals of lubrication.

Numbers correspond with reference numbers on the illustrations.

Detailed specifications of the lubricants are listed on pages 35 and 36.

△—Daily or After Every 10 Hours of Operation



Illustration 30
Air cleaner oil cup



Illustration 38A
Crankcase oil filler

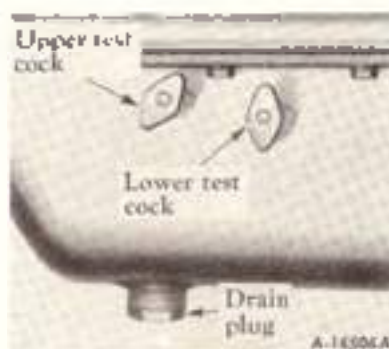

Illustration 38B
Oil level test cocks.



Illustration 38C
Steering shaft rear bearing.

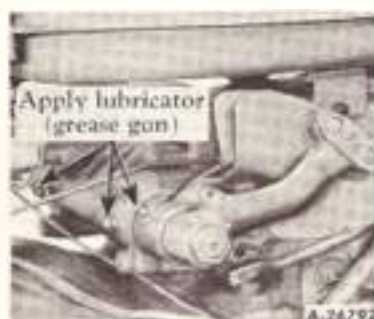

Illustration 38D
Rockshaft arms and bearings



Illustration 38E
Clutch pedal and shaft

1—Air cleaner.

2—Oil filler.

3—Lower oil level test cock.

4—Upper oil level test cock.

5—Steering shaft rear bearing.

6—Rockshaft arms.

7—Rockshaft bearings (2).

8—Clutch pedal
Brake pedal (1)

9—Rear axle bearings (2).

10—Steering shaft center bearing.

11—Clutch shaft.

Clean and refill the oil cup to the oil head with the same new oil used in the crankcase. The capacity is $\frac{3}{4}$ U.S. pint. See Illustrations 39 and 30 for further information. See Illustration 38B for further information.

When operating on gasoline: Add sufficient new oil to bring the oil up to the level of the upper test cock (4).

When operating on distillate: Before starting the engine for the day's work, drain the oil down to the lower test cock and add new oil as follows:

Open lower test cock (3) in the crankcase and allow the oil to drain to this level. Close the lower test cock and open upper test cock (4) then add new oil through crankcase oil filler (2) until the oil appears at the upper test cock (approx. one U.S. pint). Close the cock. Do not operate the engine if the level of the oil is below the lower test cock. See Illustrations 38A and 38B.

Use pressure-gun grease (chassis lube) and apply two or three strokes of the lubricator or sufficient grease to flush out the old grease dirt. See Illustrations 38C to 38E inclusive.

LUBRICATION



Illustr. 39

Rear axle bearing and brake pedal.



Illustr. 39A

Steering shaft center bearing and clutch release bearing retainer.



Illustr. 39B

Fast-Hitch



Illustr. 39C

Magneto (tractors so equipped).

Adjustable Wide Front Axle

- 12—Tie rod (4).
- 13—Steering knuckle post (2)
- 14—Front axle pivot shaft.
- 15—Shay rod bearing, Fast-Hitch
- 16—Lateral link (2)
- 17—Outside bearing race (2).
- 18—Shay link and swivel (2)

Use pressure-gun grease (chassis lubricant) and apply two or three strokes of the lubricator, or sufficient grease to flush out the old grease and dirt. See *Illustr. 37 and 37B*.

○—Weekly or After Every 60 Hours of Operation

- 19—Impulse coupling (tractors with magneto).

Use a light oil, such as sewing machine or cream separator oil, and oil liberally. Use kerosene when the temperature is below -10°F . See *Illustr. 39C*.

Miscellaneous parts.

Lubricate the clutch and brake pedal connections with a few drops of engine oil.

◇—After Every 120 Hours of Operation

- 20—Generator oil cups (2).

Use an oil can and apply eight to ten drops of SAE-20 oil in each cup. See *Illustr. 39D*.

- 21—Clutch release bearing retainer.

Use pressure-gun grease (chassis lubricant) and apply two or three strokes of the lubricator. Do not overlubricate. The fitting can be reached by removing the clutch housing dust cover from the left side of the clutch housing. See *Illustr. 39A*.

- 22—Oil filter element.

- 23—Oil filter drain plug.

Replace the oil filter element every time the crankcase oil is changed. Remove oil filter drain plug (23) and allow all oil to drain out. Remove the oil filter retaining bolt and case and remove the used filter element. Replace the drain plug and install a new filter element as instructed on page 34. See *Illustr. 39E*.

- 24—Crankcase oil pan drain plug.

Remove plug (24) and drain all oil from the crankcase while the engine is warm; then refill with new oil to the level of upper test cock (4). The crankcase pan capacity is five (5) U. S. quarts. See *Illustr. 38B*. For the correct lubricating oil to use, see the lubrication specifications on pages 35 and 36.

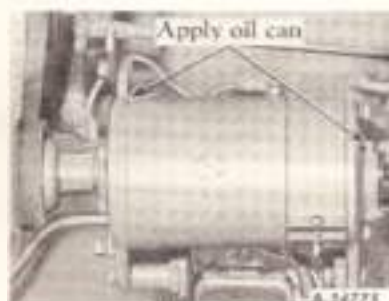

Illustr. 39D

Generator.



Illustr. 39E

Oil filter.

LUBRICATION

□—Every Six Months or After Every 500 Hours of Operation



Illust. 40
Fan hub.

25—Fan hub.

Turn the fan hub so oil retainer screw (25) is to the left horizontal position. Remove the screw and fill the hub to the level of the filler hole opening with engine oil. Now turn the fan hub so the oil filler hole is on the bottom, to allow the excess oil to drain off. Replace the oil retainer screw. See page 49 for further information. See *Illust. 40*.



Illust. 40A
Cranking motor.

26—Cranking motor.

Put a few drops of SAE-20 oil in the cranking motor oil cup. See *Illust. 40A*. See page 63 for further information.



Illust. 40B
Distributor.

27—Distributor.

Remove the grease plugs and insert lubrication fittings. Apply pressure-gun grease (chassis lubricant) to the distributor fitting until a small quantity comes out of the relief hole opposite the plug. Apply several strokes of the lubricator to the drive housing fitting. See *Illust. 40B*.

Remove the distributor cap and the distributor rotor, and apply one or two drops of light engine oil to the felt in the hole at the end of the breaker cam. See pages 51 and 52 for complete information on distributor lubrication.

28—Magneto distributor bearing (tractors with magneto).

Fill the distributor bearing oil cup with very light oil, such as cream separator or sewing machine oil. See pages 54 and 55 for complete information on magneto lubrication. See *Illust. 39C*.

29—Front wheels

Remove, clean, and repack the front wheel bearings with fiber grease. See page 33 for further instructions.



Illust. 40C
Transmission filler plug.



Illust. 40D
Transmission oil level and drain plug.

LUBRICATION

○—Periodic

Check the oil level periodically. Use approved lubricant (SAE-80) and keep the lubricant up to level plug (31) on the right rear side of the transmission case (*Illust. 40D*). Change the oil in the transmission case at least once a year. However, do not drive the tractor more than 1,000 hours without changing the oil. Remove drain plug (32) and allow all the oil to drain out (*Illust. 40D*). Replace the drain plug and remove filler plug (30) and level plug (31). Refill with approved lubricant (SAE-80) up to the level plug opening and replace the plugs (*Illusts. 40C and 40D*). For the capacity of the transmission case, see the "Lubrication Table" on page 36.

The belt pulley is automatically lubricated from the transmission; therefore plug (33) is used only as an inspection hole plug. Remove drain plug (34) and allow all oil to drain out of the belt pulley housing each time the oil is changed in the transmission. See *Illust. 41*.

Check the oil level periodically and add sufficient approved lubricant to bring it up to the level of plug (35).

Keep the hole in the vent plug (*Illust. 41A*) open at all times to relieve the pressure which may build up due to temperature changes.

Change the oil at least once a year. However, do not operate the tractor more than 1,000 hours without changing the oil. Once a season, or when necessary, drain by removing plug (36) and refill with new lubricant (capacity $1\frac{1}{2}$ U.S. pints). See *Illust. 41A*.

Use pressure-gun grease (chassis lubricant). After every 1,000 hours or at least once every year, apply a few strokes of the lubricator to clutch release bearing fitting (37) or just enough grease until it starts to come out of the bleeder hole on top of the bearing retainer. To reach the fitting, remove clutch housing handhole cover "A." See *Illust. 37*. Also see *Illust. 41B*.

See pages 77 and 78.

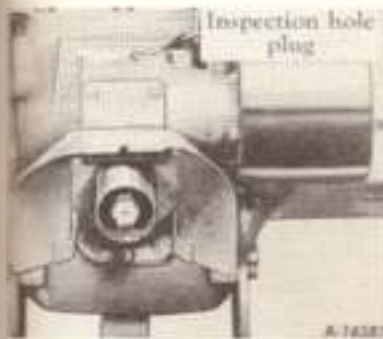

Illust. 41

Belt pulley housing.

Transmission

- 30—Oil filler plug.
- 31—Oil level plug.
- 32—Oil drain plug.

Belt Pulley Housing

- 33—Inspection hole plug.
- 34—Drain plug.



Illust. 41A

Steering gear housing.

Steering Gear Housing

- 35—Filler and level plug.
- 36—Drain plug.



Illust. 41B

Clutch release bearing.

- 37—Clutch release bearing.

Touch-Control Reservoir

- 38—Filler and level plug.
- 39—Drain plug.
- 40—Strainer.

MAINTENANCE

Periodic Inspections

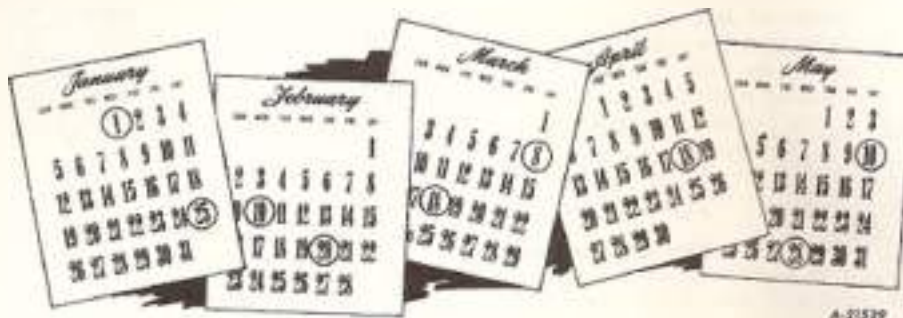

To keep your tractor performing efficiently, it is advisable to systematically inspect the following points at intervals as outlined below

After Every 10 Hours of Operation

- Air cleaner cap..... Remove dirt or chaff.* See page 30.
- Air cleaner oil cup..... Remove, clean and refill. See pages 49 and 50.
- Cooling system..... Check the level of the coolant in the radiator. See page 47.
- Lubrication points..... See the "Lubrication Guide."

After Every 60 Hours of Operation

- Air cleaner, complete..... Remove and clean * See pages 49 and 50.
- Fan belt and generator belt..... Check the tension, replace the belts when necessary. See pages 48 and 60.
- Flexible rubber connections between air cleaner and carburetor..... Inspect for loose fit or damage.
- Radiator core..... Clean the spaces. See page 48.
- Lubrication points..... See the "Lubrication Guide."

After Every 120 Hours of Operation

- Crankcase breather cap..... Remove and clean.
- Engine crankcase..... Drain and change the oil.
- Lubricating oil filter..... Replace the filter element. See page 34
- Spark arrester..... Remove the pipe plug and run the engine at low idle until all loose particles are removed. Replace the plug.
- Storage battery..... Check the liquid level and specific gravity. See page 64
- Lubrication points..... See the "Lubrication Guide."

After Every 250 Hours of Operation

- Fuel strainer and sediment bowl..... Take apart and clean. See page 43.
- Magneto breaker points and chamber (tractors with magnetos)..... Clean the chamber and check the breaker points and breaker point opening. See page 55.
- Magneto drive chamber and impulse coupling (tractors with magnetos)..... Check and clean if necessary. See "Cold Weather Precautions" on page 45.
- Spark plugs..... Remove and clean; check the gaps. See page 51.

*When unusual dust or dirt conditions are encountered during operation, it may be necessary to service more frequently

MAINTENANCE

After Every 400 Hours of Operation

brake pedals.....	Check for free movement and equalization. See page 67.
latch pedal.....	Check for free movement. See page 68.
engine valves.....	Check for clearance. See page 66.
fuel line screen (at carburetor).....	Remove and clean. See page 41.

Every 6 Months or After Every 500 Hours of Operation

cooling system.....	Clean. See page 47.
distributor breaker points and chamber.....	Clean the chamber and check the breaker points and breaker point opening. See page 52.
front wheels.....	Clean and repack with new grease. See page 35.
lubrication points (1,000 hours).....	See the "Lubrication Guide" (Periodic).

Fuel Strainer

Cleaning the Fuel Strainer and Sediment Bowl

Clean the fuel strainer after every 250 hours of operation. To do this, proceed as follows:

1. Close all shut-off valves.
2. Take the strainer apart by loosening the lower jam nut.
3. Clean the sediment bowl and clean the screen if necessary.
4. When reassembling, be sure the cork gasket between the bowl and the main body is in good condition and does not leak. Use a new gasket if necessary.

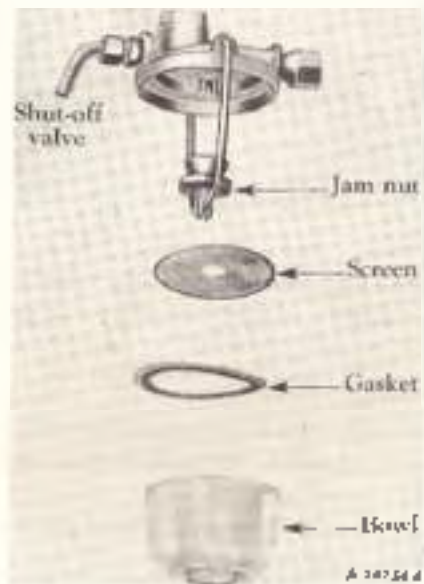

Illustr. 43

Fuel strainer showing the glass bowl removed for cleaning.

Carburetor

Use clean fuel; the presence of dirt and water will disturb the functioning of the carburetor. Clean the fuel screen after every 400 hours of operation.

The fuel screen can be removed for cleaning by unscrewing the fuel line fitting and removing the elbow; clean the screen and replace it.

The flange nuts which hold the carburetor to the manifold should be checked periodically for tightness.

Occasionally check cover screws "A" (Illustr. 44 or 44A) which fasten the fuel bowl to the fuel bowl cover. They should be kept tight to avoid any air leakage past the fuel bowl cover gasket.

The engine and carburetor are correctly set when shipped from the factory. If this setting has been disturbed for any reason, proceed as follows:

Adjusting the Idle Adjusting Screw

Close the idle adjusting screw to its seat by turning it to the right (or in); then open it one turn. Start the engine and operate it at fast idling speed (without any load) until thoroughly warm. Cover the radiator if necessary or close the radiator shutter if the tractor is so equipped.

Continued on next page.

MAINTENANCE

Adjusting the Idle Adjusting Screw—Continued

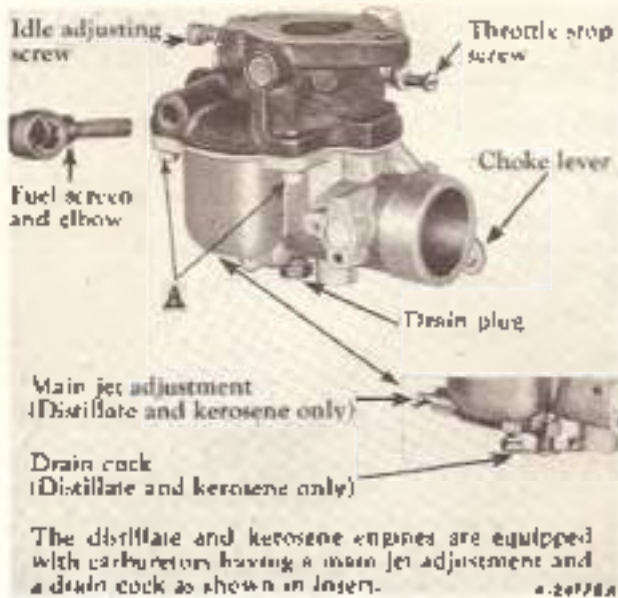

Illust. 44

Carter gasoline carburetor adjustments. (The distillate or kerosene carburetor is similar except for the parts shown in the lower right corner.)

While the engine is running at fast idle speed, it is advisable to screw in the throttle stop screw a few turns to prevent the engine from stopping when the throttle is closed. Now close the throttle by pulling the engine speed control lever all the way back. The engine will then be idling at a fairly high speed and the throttle stop screw can be backed out a little at a time until the desired idle speed is obtained.

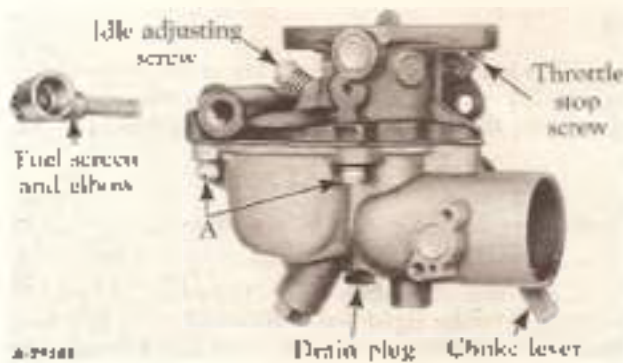

Illust. 44A

Zenith gasoline carburetor adjustments. The distillate or kerosene carburetor has a main jet adjustment similar to the Carter carburetor shown in Illust. 44.



Illust. 44b

Carburetor adjustment.

If the engine misses or rolls while backing out the throttle stop screw, the idle adjusting screw may be adjusted either in or out until the engine operates smoothly. Speed up the engine for a few seconds, then recheck the idle adjustment. A slight adjustment in or out will give the smoothest idle.

Main Jet Adjustment

(For Distillate or Kerosene Carburetors)

If your tractor is equipped for distillate or kerosene operation, set the manifold heat control lever in the hot position (Illust. 6C) and allow the engine to operate on gasoline until thoroughly warmed up. The pointer on the heat indicator should be in the center of the "RUN" section. Now change over to operate on distillate or kerosene and operate the engine a short time before making any adjustments.

To regulate the main jet adjustment, advance the engine speed control lever to the fast idle position (push forward in advance), and turn the main jet adjustment clockwise until the fuel flow is shut off and the speed of the engine drops because of the lean mixture; then open until the engine runs smoothly. After the engine has been put under load, readjust the main jet adjustment if necessary. Always adjust so that the engine operates smoothly with as lean a mixture as possible.

Recheck the idling speed as described under "Adjusting the Idle Adjusting Screw."

If the engine is not receiving the correct amount of fuel, it may be that the main jet adjusting screw has loosened. If necessary, tighten the adjusting screw packing nut securely.

MAINTENANCE

Removing the Carburetor

1. Shut off the fuel supply at the fuel tank.
2. Drain the carburetor by removing the drain plug when operating on gasoline, or by opening the drain cock when operating on distillate or kerosene. After the carburetor has drained completely, close the drain cock or replace the drain plug.
3. Disconnect the choke and governor controls.
4. Disconnect the fuel line.
5. Remove the air cleaner connections to the carburetor.
6. Remove the complete carburetor by removing cap screws or nuts "A" (Illustr. 45) which fasten it to the manifold.

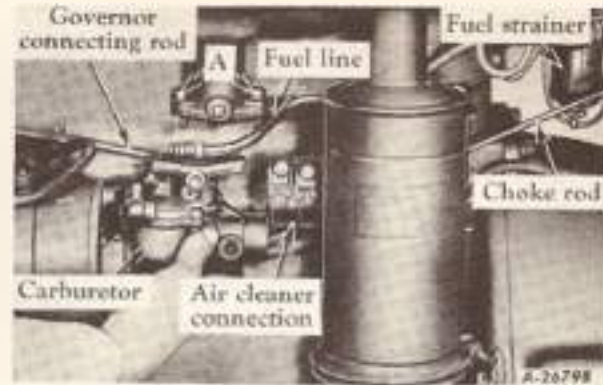

Illustr. 45
Removing the carburetor.

Installing the Carburetor

1. Install the carburetor on the engine in the reverse order of removal.

2. Turn on the gasoline supply.
3. Adjust the carburetor as described previously.

Cold Weather Precautions

When operating the tractor in temperatures of $+32^{\circ}\text{F}$. or lower, observe the following precautions:

Fuel System

Use only a high-test, winter-grade gasoline for starting, and keep your supply in a closed container so the more volatile portion does not evaporate.

Fill the fuel tank at the end of the day's run to prevent moisture from collecting in the tank.

Lubrication

Be sure to use lubricant of the correct viscosity in the engine crankcase, air cleaner and magneto impulse coupling, as specified in the "Lubrication Table."

Magneto Impulse Coupling (Tractors with Magneto)

For satisfactory starting, it is important to keep the magneto impulse coupling oiled liberally, as specified on page 29. Keep the impulse coupling free of dirt and gummy rust formation.

When the engine is hand-cranked, the impulse coupling should trip (click) twice for each revolution of the engine; failure to do so may indicate need of oiling. To clean the magneto, remove it as described on page 36 and flush the impulse coupling and magneto drive chamber with kerosene.

Cooling System

When the temperature is likely to be $+32^{\circ}\text{F}$. or

lower, there is danger of the water freezing in the cooling system.

To prevent this, drain the water from the cooling system at the end of each run or use one of the recommended antifreeze solutions.

Draining and Refilling the Cooling System

1. Remove the radiator drain pipe cap on the lower left side of the engine. See Illustr. 47.
2. See that the drain hole is not plugged and that the water drains completely. Then replace the drain pipe cap.

Important! In freezing weather, follow this procedure when filling the radiator and cooling system:

Have sufficient water to fill the cooling system available at the tractor (warm water is desirable).

Close the radiator shutter (if the tractor is so equipped) or cover the radiator.

Start the engine and immediately fill the radiator and cooling system with water.

This method prevents the rubber sealing rings on the cylinder sleeves from becoming overheated before the engine is filled with water and also prevents the water from freezing during the warm-up period. For engines using distillate or kerosene, adjust the radiator shutter to maintain the operating temperature of the engine in the center of the "RUN" range on the heat indicator (Illustr. 6A), or on the low side of the "RUN" range for gasoline fuel.

MAINTENANCE

Antifreeze Solutions

The following table shows the quantity of antifreeze to be added to the cooling system for various temperatures:

Freezing Point (Fahrenheit)	Pints of antifreeze required		
	Ethylene Glycol	Distilled Glycerine	Denatured Alcohol
+10°	7½	10	9
0°	10	12	11
-10°	12	14	13
-20°	13½	16	15
-30°	15	18	17
-40°	16½	—	19½
-50°	17½	—	21½
-60°	18½	—	23½
-70°	19½	—	—

The use of alcohol as an antifreeze is not recommended because denatured alcohol boils at +173°F. However, if it is necessary to use alcohol, check the solution frequently to make certain you have adequate protection for the prevailing temperature.

Note. Use only one type of antifreeze solution.

Do not mix solutions, as it will be difficult to determine the exact amount of protection.

Never use any of the following in the cooling water as an antifreeze.

Honey, salt, kerosene, fuel oil, glucose or sugar, calcium chloride, or any alkaline solution.

If an antifreeze solution is to be used, observe the following instructions:

1. Inspect the hose connections. They must be in good condition inside and out. Then tighten all water connections.

2. Inspect the fan belt and adjust it to the proper tension as described on page 48. If the belt is worn or oil soaked, it is best to install a new one.

3. Drain and clean the cooling system as described on page 47.

4. Make sure the radiator drain is tightly closed. Pour the required amount of antifreeze into the cooling system. Fill the radiator with clean water (use soft or rain water if possible) to a level approximately 2¼ inches below the top of the filler neck. Then inspect all hose connections for leaks.

Cooling System

Adding Water to the Cooling System

Caution! If the water in the cooling system is hot and water is to be added, observe the following:



If the motor overheats, allow the engine to cool off before removing the cap to fill the radiator. When removing the cap, be extremely careful to avoid being scalded by steam which has built up pressure in the radiator.

The cooling system operates under pressure which is controlled by means of a regulating valve built into the radiator cap. Always use clean water (soft or rain water if possible).

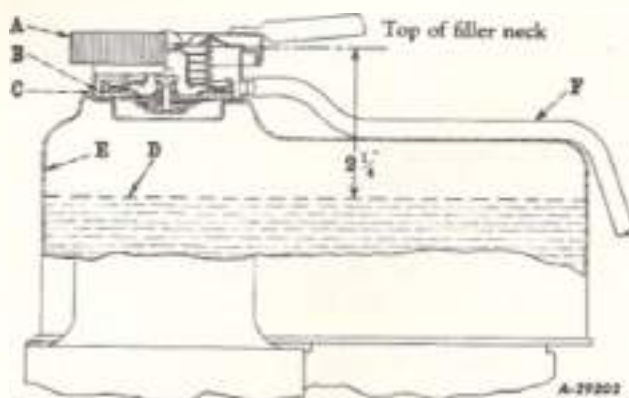

Figure 46

Water level in pressure-cooled radiator

"A" Radiator cap.

"B" Filler cap gasket.

"C" Filler neck.

"D" Water level.

"E" Upper water tank.

"F" Overflow pipe.

MAINTENANCE

Turn radiator cap "A" (see *Illustr. 46*) slowly counterclockwise to the safety stop to allow the pressure or any steam to escape; then press down on the cap and continue to turn until the cap is free to be removed.

Allow the engine to cool and fill the radiator slowly to approximately $2\frac{1}{4}$ inches below the top of filler neck "C." Due to expansion, when the system becomes hot any excess water will be discharged through overflow pipe "E."

Note: Do not pour cold water into the radiator if the engine is very hot unless conditions make it absolutely necessary. In this case start the engine and let it idle; then slowly pour the water into the radiator.

Before replacing the filler cap, be sure to remove any chaff or dirt particles which may be on the gasket surface or cap, and tighten the cap clockwise to the stop.

Note: A pressure-cooled system will not operate properly unless the cooling system is right.

The gasket surface must be in good condition. The cap must be properly tightened to the stop, and the system must not have loose connections or leaks. Unless these instructions are followed, pressure will not be maintained, and loss of water and consequent overheating will result. When draining the radiator, always remove the filler cap to permit complete drainage.

Do not attempt to repair or replace any of the regulating valve parts. If the valve is faulty, replace it with a new radiator cap of the same type.

Filling the Cooling System

1. The water capacity of the cooling system is approximately 15 U.S. quarts.
2. Replace the drain pipe cap.
3. Fill the radiator to a level approximately $2\frac{1}{4}$ inches below the top of the filler neck. Filling the radiator to this level will allow for expansion of the coolant under normal operating conditions.

Fill the radiator slowly. This permits air to escape from the cylinder head, allowing the cooling system to be filled to its maximum capacity.

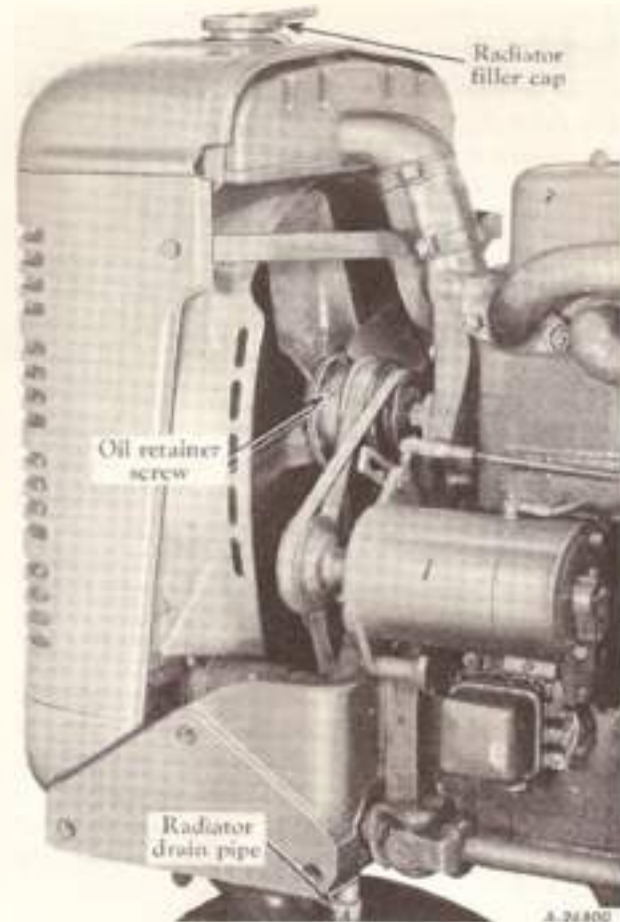

Illustr. 47
Cooling system

Cleaning Out Dirt and Sludge

1. Drain the cooling system by removing the drain pipe cap. See *Illustr. 37*. Allow the system to drain; then replace the cap.
2. Fill the cooling system with a solution of two pounds of ordinary washing soda mixed with 15 U.S. quarts of water (cooling system capacity).
3. Leave off the radiator filler cap and operate the engine until the water is hot; then drain and flush with clean water.

Rust Prevention

One of the most common causes of engine overheating is a rust-clogged cooling system. Rust interferes with circulation and cooling, which causes overheating.

Continued on next page.

MAINTENANCE

Rust Prevention—Continued

In localities where alkaline, acid, or saline waters are the only kind available, the addition of a rust preventive or "inhibitor" will tend to minimize the corrosive action of such waters.

For rust prevention during winter use of the engine, a fresh filling of antifreeze containing an effective corrosion preventive should be used. In the spring, drain and discard the old antifreeze solution, as the rust preventive or "inhibitor" may be exhausted from contamination and continued use.

After draining the antifreeze, a rust preventive should be added to the cooling water to protect the cooling system during warm weather operations. This inhibitor solution should be drained and discarded in the fall when danger of freezing again makes necessary the use of an antifreeze.

Thermostat

The water is circulated through the engine block, cylinder head and radiator by a belt-driven water pump. Circulation is controlled by a thermostat that prevents the water from flowing through the radiator until the engine has reached operating temperature. With the thermostat closed, water circulates only through the engine block.

Radiator Care

Overheating is often caused by bent or clogged radiator fins. If the spaces between the radiator fins become clogged, clean them with forced air or water. When straightening bent fins, be careful not to injure the tubes or to break the bond between the fins and the tubes.

Fan Belt

Fan Belt Tension

The slack of the fan belt should be checked after every sixty hours of operation to assure maintenance of the correct tension. The tension is correct when the belt can be depressed without effort by your thumb approximately $\frac{3}{8}$ inch to one inch midway between the two pulleys. See *Illustr. 4B*. If the slack is more than one inch, adjust the belt as follows:

Adjusting the Fan Belt

Loosen generator mounting bolts "A" and nut "B" (*Illustr. 4B*) before adjusting the fan belt tension. The tension of the fan belt can be adjusted by loosening fan spindle "C" and moving the fan and hub

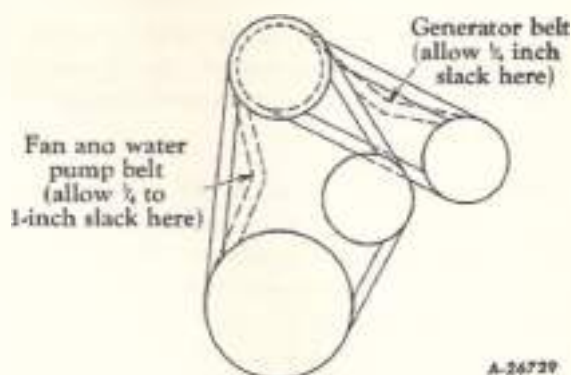

Illustr. 4B

Correct belt tension.

assembly up or down until the correct tension is obtained. After obtaining the correct tension, tighten fan spindle "C."

To adjust the generator belt, see the instructions below. After a new belt has been in use approximately fifty hours, check the tension and adjust again if necessary.

Adjusting the Generator Belt

After the fan belt tension has been adjusted, move the generator toward or away from the engine to get the correct generator belt tension. The tension is correct when the belt can be depressed without effort by your thumb approximately $\frac{3}{8}$ inch midway between the two pulleys (*Illustr. 4B*). After the proper adjustment has been made, tighten bolts "A" and nut "B" (*Illustr. 4B*).

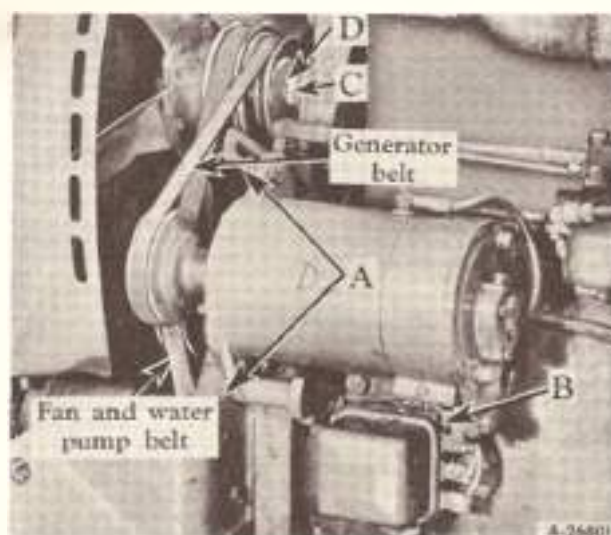

Illustr. 4B

Fan and generator belts.

MAINTENANCE

Removing the Fan Belt

To remove the fan belt, loosen fan spindle "C" (Illustr. 48A) and slide the spindle to the bottom of the groove in the fan bracket. The fan belt can then be slipped over the water pump pulley and the bottom drive pulley, and then worked up over the fan blades.

Replacing the Fan Belt

Replace the fan belt when it becomes soaked with grease, or when it is so badly worn that it does not drive the fan at the proper speed.

When replacing the belt, reverse the procedure outlined under "Removing the Fan Belt," except that the belt can be started on the lower pulley and the water pump pulley by hand. By slowly cranking the engine, the belt will find the correct position.

Fan Hub Lubrication

Every six months or after every 500 hours of operation, whichever occurs first, remove the oil retainer screw (Illustr. 47) and turn the fan assembly so the oil filler hole is in the left horizontal position.

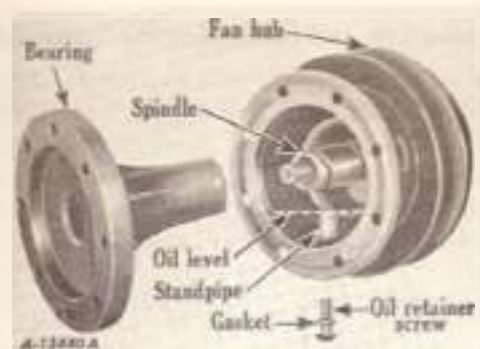

Illustr. 49

Fan hub partially disassembled, showing the oil level.

Add engine oil until the oil reaches the level of the hole. Now turn the assembly so the hole is at the bottom and allow any excess oil to drain out. The oil is then up to the level of the top of the stand pipe (approximately $1/10$ U. S. pint). See Illustr. 49. Replace the oil retainer screw and be sure the retainer screw gasket is in place.

Note: The rubber gasket located behind the hub at "D" (Illustr. 48A) is used for shipping purposes only. It does not have to be replaced when worn out.

Air Cleaning System

Clean air for combustion is assured by an oil-type air cleaner. A heavy screen in the air intake cap prevents large particles from entering the air cleaner. The air then passes to the oil cup, where it goes through a barb of oil. As the air rises to the intake manifold, it passes through a series of oil-barbed screens and the fine dust is removed. As the oil from the screens works back down, it carries the dirt with it and settles in the oil cup. Never allow dirt to build up in the oil cup to more than $3/8$ inch deep.

Oil Cup Service

Remove, clean and refill the oil cup every day, or after every ten hours of operation (more frequently when operating under dusty conditions). Refill the oil cup to the oil level head with oil of the same viscosity used in the engine crankcase. The capacity of the oil cup is $3/8$ U. S. pint.

Do not remove the oil cup while the engine is operating.

Before replacing the oil cup, clean or wipe the oil or grit from the top bead of the oil cup, the retaining clamp, and the surface under the clamp.

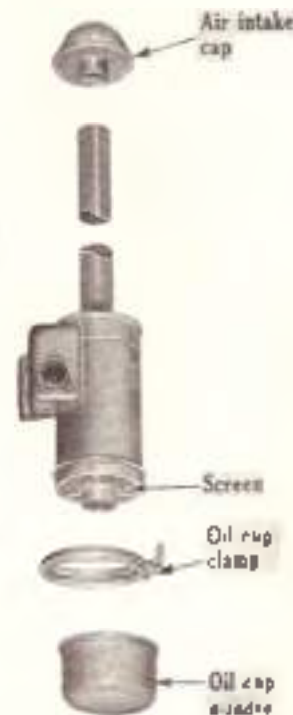

Illustr. 49A

Exploded view of the air cleaner.

MAINTENANCE

Air Intake Cap and Screen (or Pre-Screener)

The screen in the air intake cap (or Pre-Screener, if used) prevents chaff and other coarse dirt from getting into the air cleaner. Keep this screen clean and free from all chaff, oil, dust, or paint, as clogged holes in the screen will reduce the power of the engine by restricting the flow of air.

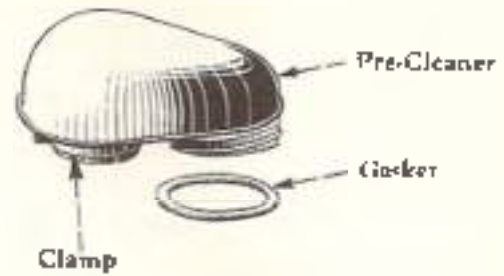

Washing the Air Cleaner

After every sixty hours of operation, particularly if operating the tractor in an atmosphere heavily laden with dust, chaff, or lint, remove the entire air cleaner from the tractor, disassemble it (Illustr. 49A) and wash the parts thoroughly in kerosene. Be sure to clean out the air intake pipe.

After all parts have been thoroughly cleaned, replace the air cleaner body on the tractor. Make sure all joints are airtight. Replace the air intake cap. Fill the oil cup to the proper level with oil of the specified viscosity and replace it on the air cleaner. Be sure it is held securely in place by the cup clamp.

General Precautions

As an added precaution against dirt entering the engine, frequently inspect the flexible rubber hose connections between the carburetor and the air cleaner. If they show any signs of deterioration, replace them. To eliminate strain on the rubber hose connections, be sure the pipes line up.

All joints between the air cleaner and carburetor, manifold and the cylinders of the engine should be tight. All gaskets must be in good condition and the bolts should be drawn up tight.

Cleaning the Pre-Cleaner

Collector-Type Pre-Cleaner

Remove and clean the dust jar frequently, at least before the jar becomes three-quarters full. Remove the Pre-Cleaner and inspect the fins regularly.

When the fins become dirty or oily, wash the entire Pre-Cleaner in kerosene. Replace the gasket and tighten the jar securely.



Collector-type Pre-Cleaner disassembled for cleaning.

Detachable-Sleeve-Type Pre-Cleaner

Empty the Pre-Cleaner when the dust reaches the dust level mark.

To clean: Loosen the wing nut and remove the cover assembly. Then lift the plastic body from the base, turn upside down and shake the dust from the dirt compartment.

Reassemble the Pre-Cleaner on the tractor. See Illustr. 50A.



Illustr. 50A

Detachable-sleeve-type Pre-Cleaner.

MAINTENANCE

Spark Plugs and Cables

Checking the Spark Plug Gap



Illustr. 51

Checking the spark plug gap (use the gaps to .023 inch).

Caution! Remove all dirt from the base of the spark plug before removing the spark plug.

Remove the spark plugs after every 200 to 300 hours of operation for cleaning and checking the gaps between the electrodes. A gap of .023 inch should be maintained. When making this adjustment, always bend the outer electrode. Never bend the center electrode, as it may damage the insulator. If the gap between the electrodes is too great, due to improper setting or burning of the ends, the engine will misfire and will be hard to start.

Cleaning the Spark Plugs

Sandblasting is the recommended method for cleaning spark plugs. Never scrape or clean the

insulator with anything that will scratch the porcelain. Scratched porcelain allows carbon and dirt to accumulate much faster.

Always use a spark plug wrench when removing or replacing the spark plugs. This helps to prevent cracking the porcelain. When replacing spark plugs, be sure the gaskets are in good condition and screw the plugs in tight. Replace defective plugs with new plugs.

See your International Harvester dealer for various makes of replacement plugs for normal or special service. These plugs have been tested and recommended as best suited for this engine.

Spark Plug Cables

If the spark plug cables are removed for any reason, note the position of each cable on the distributor or magneto. *Illustr. 52* or *54A* shows the correct wiring.

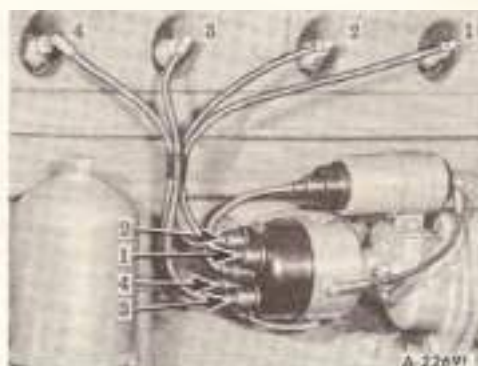

Illustr. 51A

Spark plug wiring. The engine firing order is 1, 3, 4, 2.

Battery Ignition Unit

Lubrication

Every six months or after every 500 hours of operation, whichever occurs first, remove the grease plugs (*Illustr. 52*) and insert lubrication fittings. Apply pressure-gun grease (chassis lubricant) to the distributor fitting until a small quantity comes out of the relief hole opposite the plug. Apply several strokes of the grease gun to the drive housing fitting.

Remove the distributor cap and the distributor rotor and apply one or two drops of light engine oil to the felt in the hole at the end of the breaker cam. See *Illustr. 52A* and *52B*.

Greasing the Breaker Mechanism and Checking the Points

It is important that the breaker chamber be kept clean because oil on the breaker points will cause rapid burning. Remove the distributor cap, distributor rotor, and the breaker cover for breaker chamber inspection. See *Illustr. 52B*. Care should be taken, when removing the breaker cover, to prevent dirt from entering the breaker chamber. Be sure the chamber is clean and that the breaker points are in good condition and have the proper opening.

Continued on next page.

MAINTENANCE

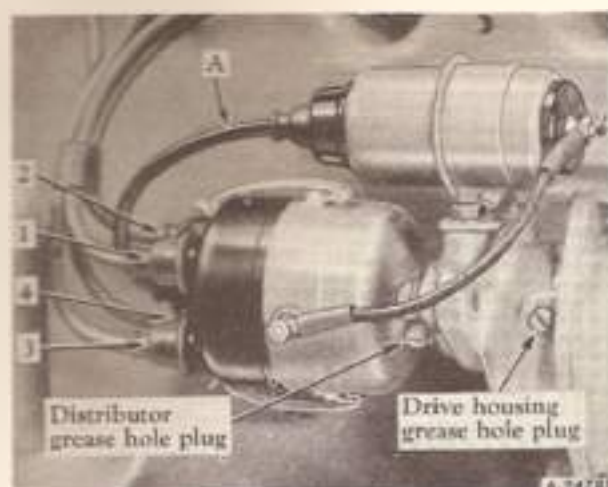

Illustr. 52
Distributor wiring and lubrication.

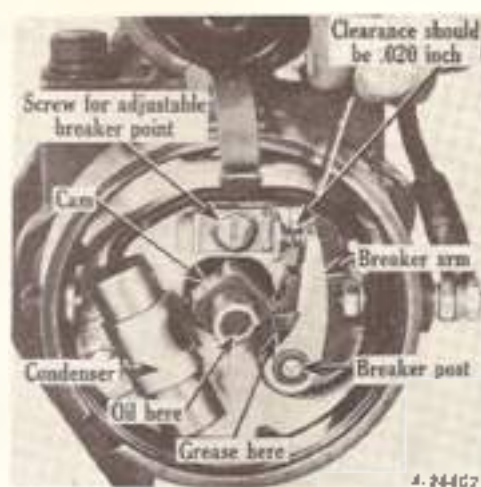

Illustr. 52A
Adjusting the breaker points.

Greasing the Breaker Mechanism and Checking the Points—Continued

Never use emery cloth or sandpaper to clean the points. If the points are worn excessively, replace both points.

Fill the recess in the breaker post with grease and pack a small quantity of magneto grease in back of the breaker arm rubbing block and apply a light coating of the same grease on the lobes and flats of the breaker cam. See *Illustr. 52A and 52B*. See your International Harvester dealer for the proper grease to use.

Check the condition of the breaker points for build-up or lip formation. If present, the points must be dressed before the points opening can be checked or set. Check the opening between the breaker points with a feeler gauge as shown in *Illustr. 52A*. The point opening should be .020 inch when the rubbing block is on the high part of the cam.

If the opening is not correct, adjust it by loosening the screw holding the adjustable point. Then move the point toward or away from the point on the breaker arm until the gauge slips snugly into the opening. After the adjustment has been made, tighten the screw.

Distributor Cap

Every three or four months remove the distributor cap and examine the inside. If any dust, moisture or oil deposits are present, thoroughly clean and wipe dry. To assure long life of the distributor, care must be taken to keep the three small ventilator holes in the distributor cap open at all times. Also see that the distributor rotor is kept clean.

If the terminal nipples are removed, be sure the distributor cap terminals and coil terminal are clean and dry. The distributor is equipped with these nipples to prevent any external electrical leakage when the tractor is operating under adverse conditions.

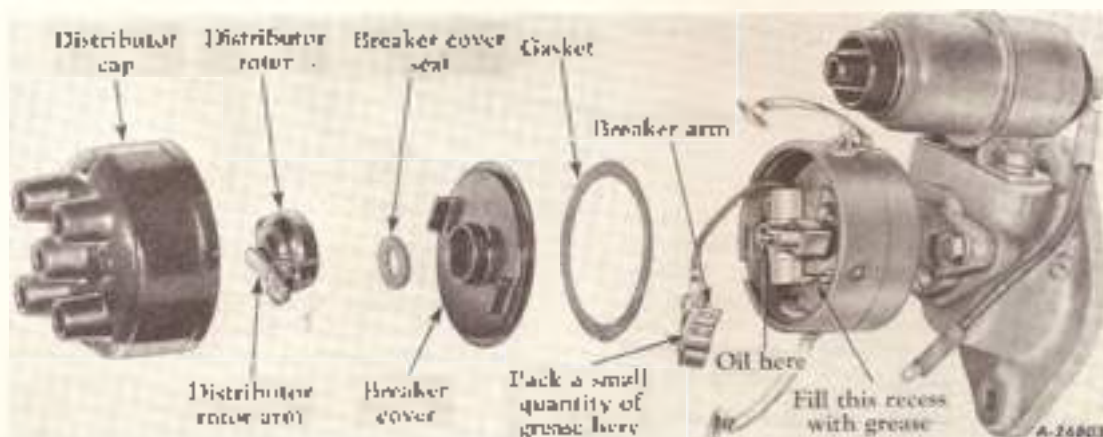

Illustr. 52B
Distributor partially disassembled for servicing.

Ignition Coil

The ignition coil does not require special service other than to keep all terminals and connections clean and tight.

Removing the Battery Ignition Unit

If it is necessary to remove the battery ignition unit for any reason, proceed as follows:

1. Disconnect ignition switch cable "C" (Illustr. 53A) from the ignition coil.
2. Pull secondary cable "A" (Illustr. 53B) out of the center socket on the distributor cap and remove the cap.
3. Crank the engine slowly until the distributor rotor arm is in the No. 1 firing position. See Illustr. 53A.
4. Remove the two cap screws and the mounting lip from the distributor drive housing flange and remove the complete unit.

Installing the Battery Ignition Unit

Note: If the gears on the drive shaft have not been disengaged or rotated at any time after the complete unit has been removed, disregard Steps 1 and 2 outlined below. Also it should not be necessary to retime the distributor to the engine.

1. Place the battery ignition unit in one hand, and with the fingers of the other hand, turn the drive lugs on a clockwise direction until the rotor arm is approximately in the No. 1 firing position. See Illustr. 53. Then continue to turn slowly and lightly until a slight resistance is felt.
2. Pull out the drive shaft to disengage the gears; then turn the shaft so drive shaft lugs "A" are approximately 35° past horizontal or approximately in the same position as drive shaft slots "B". See

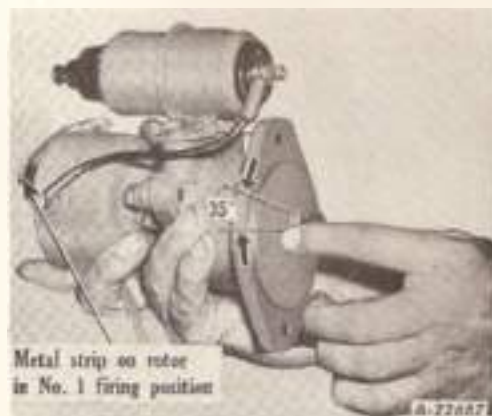

Illustr. 53

Adjusting the distributor rotor and drive shaft just for timing the distributor



Illustr. 53A

Assembling the battery ignition unit

Illustr. 53A. Engage the gears and press the drive shaft in with the palm of the hand.

3. Assemble the battery ignition unit and gasket and fasten with the mounting bolts and washers, using the mounting clip in front of the lock washer on the top bolt. Assemble the distributor cap.
4. Connect switch cable "C" (Illustr. 53A) to the negative (-) terminal on the ignition coil.

Timing the Distributor to the Engine

Loosen distributor mounting bolts "B". See Illustr. 53B. Set the engine on the top dead center of the No. 1 firing stroke. The secondary cable should be assembled properly in the coil terminal. Pull out the ignition switch button and note if the ammeter shows discharge. If the ammeter shows

Continued on next page.



Illustr. 53B

Advancing the distributor while holding the secondary cable 1/4 to 3/8 inch from the primary terminal

MAINTENANCE

Timing the Distributor to the Engine—Continued

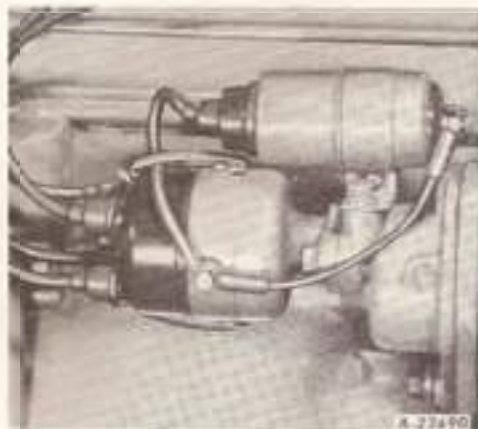

Illustr. 54

Showing the secondary cable held under the distributor cap spring for final check of timing.

discharge, the points are closed and retarding the distributor is not necessary. If the ammeter does not show discharge, retard the distributor by turning the body about 30° in the same direction as the cam rotation. Pull secondary cable "A" (Illustr. 53B) out of the center socket on the distributor cap and hold the free end of the cable within $\frac{1}{16}$ to $\frac{3}{16}$ inch from the distributor primary terminal as shown in Illustr. 53B. Advance the distributor by turning the distributor body slowly in a direction opposite to the cam rotation until a spark occurs.

Place the secondary cable under the distributor cap spring and place the terminal within $\frac{1}{16}$ to $\frac{3}{16}$ inch of the distributor primary terminal as shown in Illustr. 54. Make a final check by cranking the engine until the timing mark approaches the timing

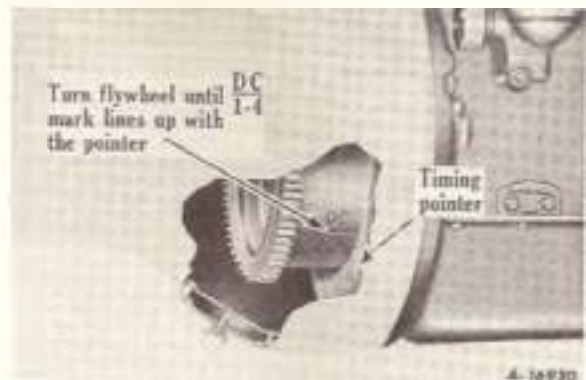

Illustr. 54A

Timing pointer.

pointer, and continuing until the spark just occurs at the gap between the secondary cable and the primary terminal. (The timing pointer can be seen by removing the handhole cover in the bottom of the clutch housing. See Illustr. 54A.) The timing marks should just be in line or slightly past top dead center (never time before top dead center). If necessary, make the required adjustment to have the spark occur as specified. Retighten the distributor mounting bolts. Assemble the rubber nipples provided and attach the spark plug cables to the spark plugs and to the terminal sockets of the distributor cap in the following order: The No. 1 cylinder spark plug to the socket marked "1" in Illustr. 52. Then, going around the distributor cap in a clockwise direction, attach the cable from the No. 3 spark plug to the next or second socket, the cable from the No. 4 spark plug to the next or third socket, and the cable from the No. 2 spark plug to the fourth or last socket. Assemble the secondary cable in the distributor cap. See Illustr. 51A and 52.

Magneto

Lubrication

Every week, or after every sixty hours of operation, oil the impulse coupling liberally with a light oil, such as cream separator or sewing machine oil. Use kerosene when the temperature is below +10°F.

Every six months, or after every 500 hours of operation, whichever occurs first, fill the distributor bearing oil cup (Illustr. 54B) with very light oil, such as cream separator or sewing machine oil.

Do not oil often, as excessive oil might work into the breaker point chamber and cause rapid point wear.

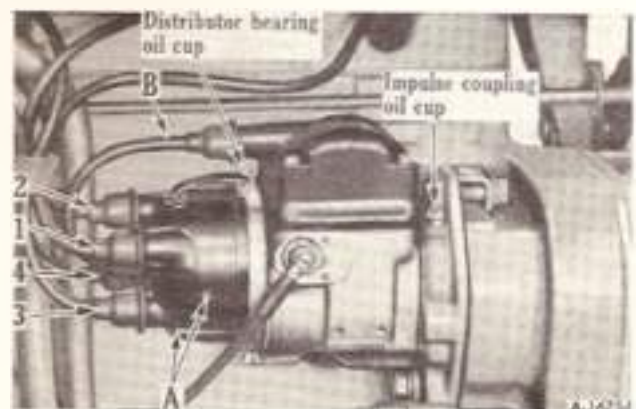

Illustr. 54B

Magneto wiring and lubrication.

MAINTENANCE

Magneto Impulse Coupling and Magneto Drive Chamber

For satisfactory starting, it is important to keep the magneto impulse coupling oiled liberally as specified on page 39. The impulse coupling should be kept free of dirt and gummy rust formation.

When the engine is hand-cranked, the impulse coupling should trip (click) twice for each revolution of the engine. Failure to do so indicates the need for cleaning or service.

After every 250 hours of operation, check the magneto drive chamber and clean it if necessary.

Remove the magneto as described on page 36 and flush the impulse coupling and magneto drive chamber with kerosene.

If it is necessary to remove the impulse coupling from the magneto for cleaning or service, we recommend this be done by your International Harvester dealer.

Greasing the Breaker Mechanism and Checking the Points

The magneto requires very little attention other than properly lubricating the oil cups as specified above. It is important, however, to keep the breaker arm chamber clean as oil on the breaker points will cause rapid point wear. Overlubrication of the distributor bearing oil cup (Illustr. 54B) might cause a dirty breaker point chamber. After every 250 hours of operation, inspect the breaker point chamber to see that it is clean. See that the points are in good condition and have the proper opening. If the chamber is clean, no attention is necessary other than checking the opening of the points; but if the chamber is dirty, all parts must be thoroughly cleaned. After cleaning, the points should be dressed, the point opening checked, and the breaker arm greased as outlined below.

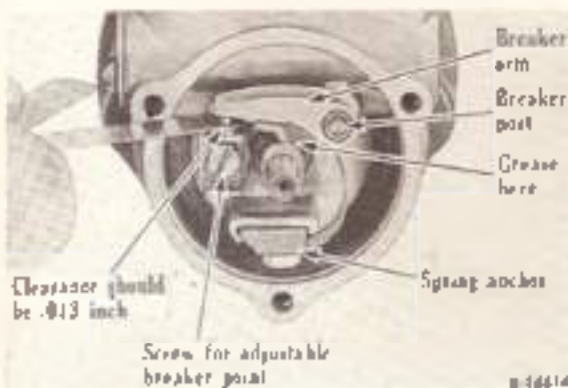

Illustr. 55

Adjusting the breaker points

To reach the breaker mechanism, remove the distributor cap and crank the engine slowly until the metal strip on the distributor rotor points toward the No. 3 terminal on the distributor cap and the impulse coupling just trips. Remove the distributor rotor. Take off the distributor body by removing three screws "A" (Illustr. 56). Do not crank the engine while the distributor body is removed or it might be necessary to return the magneto to the engine.

Remove the breaker arm and anchor from the chamber and clean all parts. Inspect the breaker points and, if necessary, dress them with a sharp, fine file. If the points are worn excessively, replace both points.

Fill the recess in the breaker post with grease and pack a small quantity of magneto grease in back of the breaker arm rubbing block. See Illustr. 55 and 56. See your International Harvester dealer for the proper grease to use.

Assemble the breaker arm, leaving the spring anchor projecting $\frac{1}{4}$ to $\frac{3}{16}$ inch above the top of the slot so it is pushed into place by the distributor body. Be sure the points line up when the breaker arm is pushed into place.

Check the opening between the breaker points with a feeler gauge. See Illustr. 55. The point opening should be .013 inch when the rubbing block is on the high part of the cam. If the opening is not correct, adjust it by loosening the screw holding the adjustable point (Illustr. 55) and moving the point up or down until the gauge slips snugly into the opening. After the proper adjustment has been made, tighten the screw.

Line up the distributor rotor key with the key-way in the spindle (Illustr. 56) and press the rotor loosely on the spindle. With the engine on the top dead center of the No. 1 firing stroke, turn the distributor rotor until the metal strip on the rotor points to the No. 1 terminal on the distributor cap. Place the distributor body on the magneto and be sure the rotor shaft enters the "D" shaped hole in the magneto rotor pinion. Remove the distributor rotor to tighten three screws "A" (Illustr. 56). Replace the distributor rotor and the distributor cap.

Greasing the Rotor Bearings and the Distributor Gear

After every 2,000 hours of operation or at least every two years, the magneto rotor bearings, distributor gear and distributor gear chamber should be cleaned and repacked with IH magneto grease. We recommend this be done by your International Harvester dealer.

MAINTENANCE

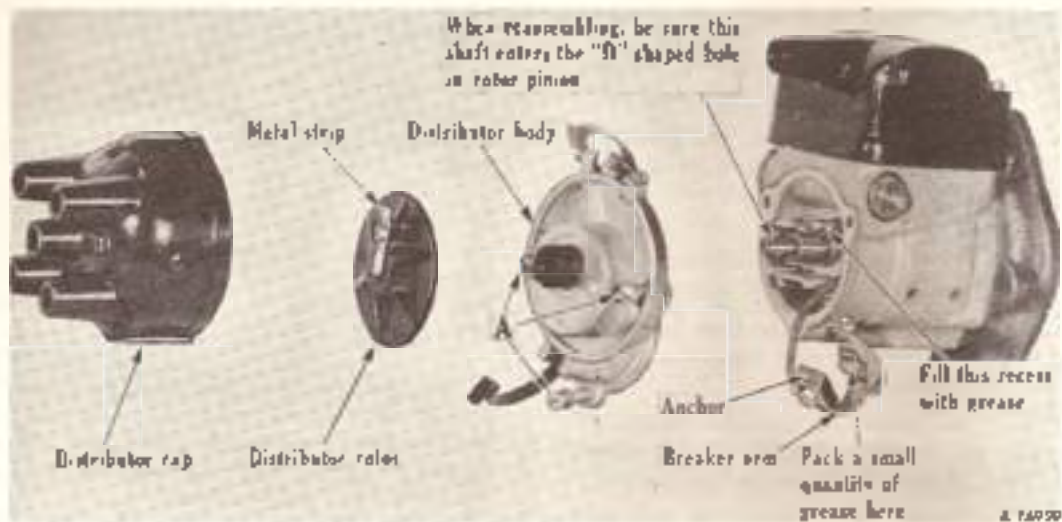

Illustr. 56

Magneto disassembled.

Distributor Cap

Every three or four months remove the distributor cap and examine the inside. If any dust, moisture or oil deposits are present, thoroughly clean and wipe dry. To assure long life of the distributor, take care to keep two small ventilator holes "A" (Illustr. 56A) open at all times. Also see that the distributor rotor is kept clean. If the distributor cap terminal nipples are removed, be sure the terminals and coil cover terminals are clean and dry. The magneto is equipped with these nipples to prevent any external electrical leakage when the tractor is operating under adverse conditions.

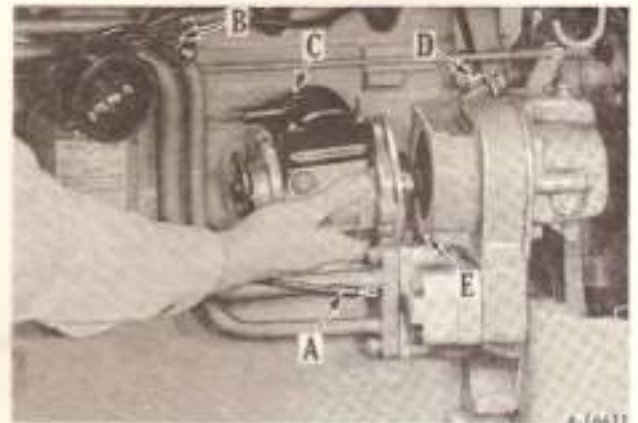

Illustr. 56A

Removing the magneto

Removing the Magneto

If it is necessary to remove the magneto for any reason, proceed as follows:

1. Disconnect ignition switch cable "A" (Illustr. 56A) by removing the Phillips head screw and lock washer attaching the cable to the magneto terminal.

2. Pull out cable "B" from coil cover "C" and remove the distributor cap.

3. Remove the cap screw and mounting clip "D," and remove the cap screw from hole "E." The magneto assembly can then be removed.

Installing and Timing the Magneto to the Engine

1. Pull out cable "B" (*Illustr. 36A*) from the coil cover end. This will eliminate any possibility of accidental starting.

2. Crank the engine until the No. 1 piston (the piston next to the radiator) is on the top dead center of the compression stroke. The compression stroke can be determined by removing the No. 1 spark plug, placing your thumb over the opening, and cranking the engine until an outward pressure is felt. Continue cranking slowly until the DC/1-4 mark on the flywheel is in line with the pointer on the clutch housing cover. Both intake and exhaust valves will now be closed. The timing pointer can be seen through the opening in the bottom of the clutch housing. See *Illustr. 57*.

3. Remove the distributor cap and turn the magneto coupling in a counterclockwise direction (as viewed from the coupling end) until the metal strip on the distributor rotor points toward the No. 1 terminal on the distributor cap. Replace the distributor cap.

4. Assemble the magneto on the engine, making sure that the lugs on the impulse coupling engage in the slots on the magneto drive coupling. (Assemble the magneto so the top is as close to the crankcase as possible.)

5. Insert the magneto mounting cap screw through the magneto flange and into hole "E" (*Illustr. 36A*). Screw the cap screw in just enough to hold the magneto in place. Crank the engine one complete revolution to the next top dead center. Pull the upper part of the magneto away from the engine until the impulse coupling just trips.

6. Fasten the upper part of the magneto to the

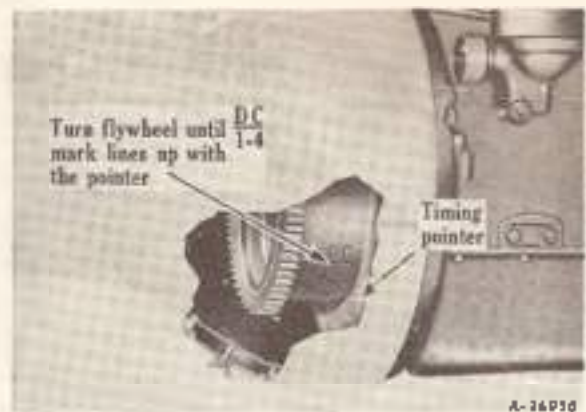

Illustr. 57
Timing pointer.

flange with the mounting clip and cap screw "D" and tighten both cap screws securely. Attach the spark plug cables to the spark plugs and to the terminal sockets of the magneto distributor cap in the following order: The No. 1 cylinder spark plug cable to the socket marked "1" in *Illustr. 54B*. Then, going around the distributor cap in a clockwise direction, attach the cable from the No. 3 spark plug to the next or second socket, the cable from the No. 4 spark plug to the next or third socket, and the cable from the No. 2 spark plug to the fourth or last socket. See *Illustrs. 52 and 54B*.

7. Connect the switch cable to the magneto terminal.

8. To check the timing, crank the engine slowly until the top dead center of the No. 1 cylinder is reached. At this time the impulse coupling should just trip.

9. The magneto is now correctly wired and timed.

10. Push cable "B" back into the socket in the coil cover (*Illustr. 36A*).

MAINTENANCE

Starting and Lighting Equipment

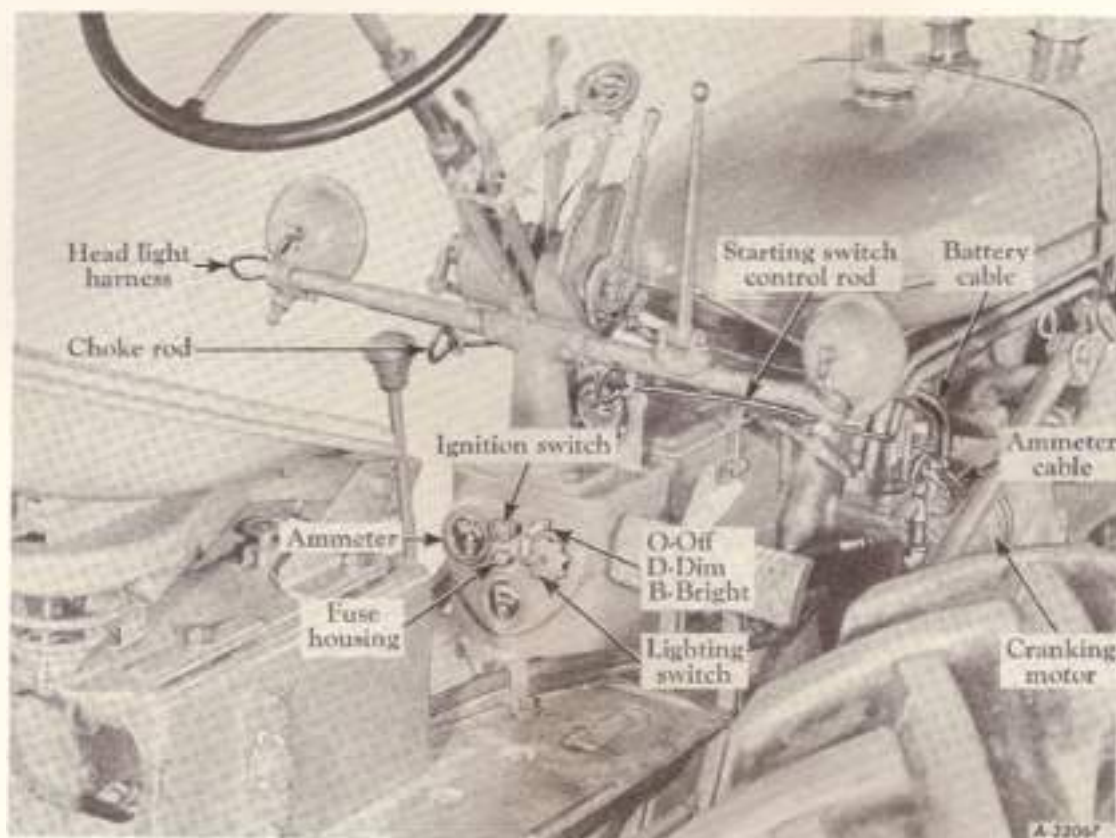

Illustr. 58

Lighting switch, ignition switch, cranking motor, etc.

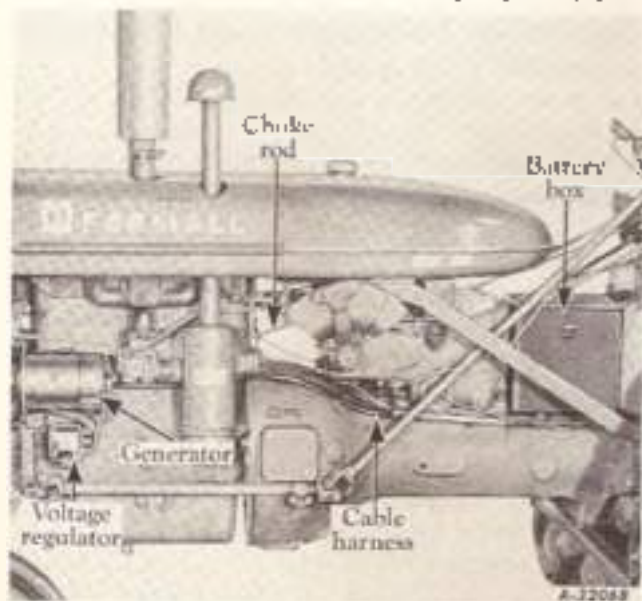

Illustr. 58A

Generator, voltage regulator, cables, etc.

Description

The electrical system of the tractor is a six-volt system and consists of a generator, voltage regulator, cranking motor, lights, lighting switch and a battery ignition unit with a six-volt battery (or a magneto, if used). The system is a single-wire type with a ground return to the battery.

Use the illustrations on pages 58 and 59 and the wiring diagrams on pages 62 and 63 as a guide for identifying the various electrical units and for tracing the electrical cables and connections. Be sure all terminals are clean and securely fastened.

When the electrical equipment is installed at the factory, the battery-to-ground cable (Illustr. 65) is disconnected and taped. Before attempting to start the tractor, make certain that the ground cable is connected.

MAINTENANCE

Headlights and Rear Light

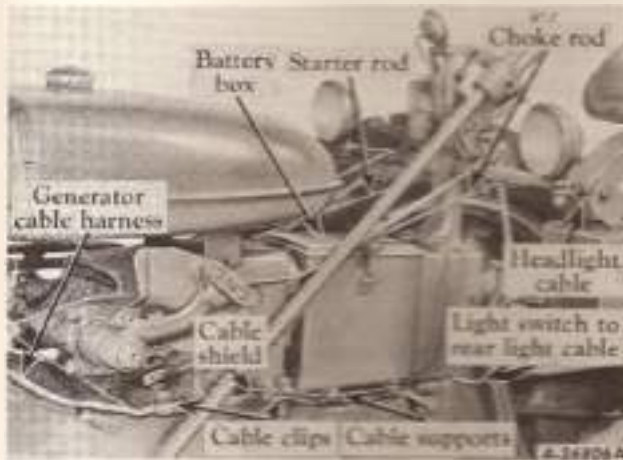

Illustr. 59
Headlights.

The headlights and rear light on your tractor are sealed-beam lights especially developed for farming operations. The parts are so constructed that the filament, reflector, lens and gasket are all assembled in a unit permanently sealed against dirt, moisture and corrosion. If a filament burns out or a lens breaks, the complete unit must be replaced. See your International Harvester Dealer.

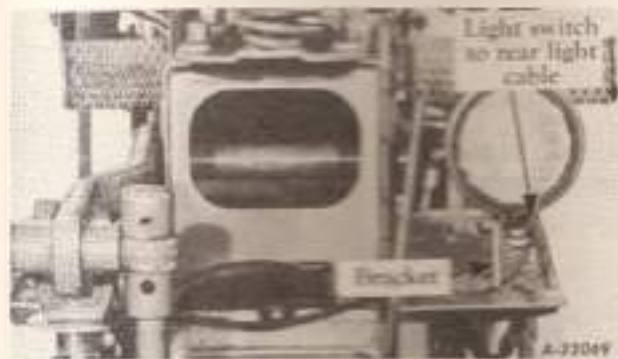

Illustr. 59A
Rear light and bracket.

Lighting Switch

The lighting switch has three positions: "O"—off position, "D"—dim lights, and "B"—bright lights.

Fuse

A cartridge-type SFE-20 fuse is located in the fuse housing between the light switch and the ammeter. If a short circuit occurs in the lighting circuit the fuse will burn out and break the circuit, preventing damage to the electrical system.

It is important to use the same capacity fuse for replacement. If the lights fail, check the fuse. If

the fuse continually burns out, check the electrical wiring for short circuits.

To install a new fuse, unscrew the fuse holder on the instrument panel (Illustr. 59B), pull out the old fuse and replace it with a new one.

Instrument Panel Connections

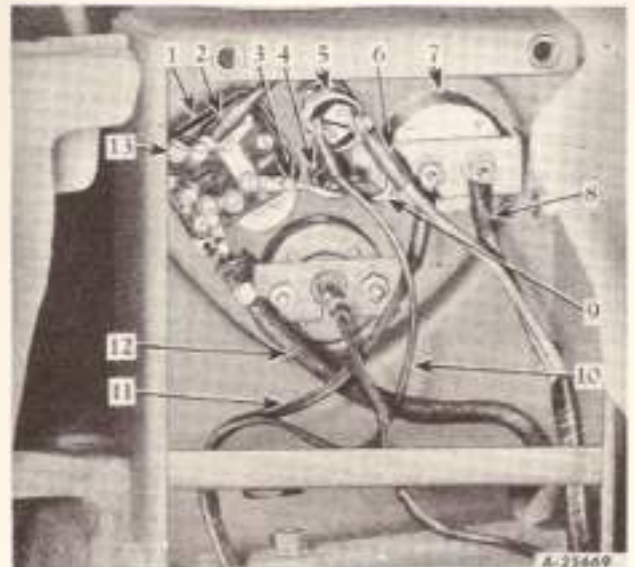

Illustr. 59B

Back of the instrument panel, showing lighting switch, ignition switch, ammeter, cables, etc. (Tractor with battery ignition)

Index to reference numbers shown in Illustr. 59B

Ref. No.	Description
1	Lighting switch
2	Lighting switch to headlights cable (black).
3	Fuse housing to lighting switch cable
4	Fuse housing.
5	Ignition switch.
6	Ignition switch to regulator "L" terminal cable (natural with green cross tracer).
7	Ammeter
8	Regulator "BAT" terminal to ammeter cable (natural with black and red cross tracers)
9	Fuse housing to ignition switch cable.
10	Ignition switch to coil cable.
11	Ammeter to cranking motor cable.
12	Lighting switch to rear light cable.
13	Dimmer resistance coil.

MAINTENANCE

Generator and Regulator

The generator supplies current to keep the battery in a charged condition, replacing the energy consumed by the cranking motor and lights. The generator on your tractor is sealed to prevent the entrance of dirt and moisture. It is hinge-mounted on the left side of the engine crankcase and is driven by a V-belt from the fan pulley. The generator, as received from the factory, has a fixed third brush which is set to give the maximum generator output.

The generator charging rate is controlled by a voltage regulator which controls the generator output, thereby maintaining a satisfactory charging rate, and prevents the battery from overcharging under varying temperatures and operating conditions. It should not require adjustment or attention. If the regulator fails to operate correctly, replace it with a new one or see your International Harvester dealer.

Caution! Do not at any time place a jumper lead between or accidentally bridge the battery terminal and the field terminal on the regulator. Serious damage to the regulator may result.

Polarizing the Generator

If the generator or the regulator has been removed or the leads disconnected, the generator should be repolarized. After the leads have been reconnected, but before the engine is started, proceed as follows:

After making certain that the grounded battery terminal is the positive (+) one, momentarily connect a jumper lead between the "BAT" terminal of the regulator and the "A" terminal of the generator. This allows a momentary surge of current to flow through the generator which correctly polarizes it. Reversed polarity may result in vibration, arcing and burning of the relay contact points.

Important! Do not touch the jumper lead to the "F" terminal on the generator, as this will damage the regulator.

Generator Belt

Generator Belt Tension

Check the slack of the generator belt to assure maintenance of the correct tension. The belt should never be loose enough to allow slippage but should not be so tight as to cause excessive side-thrust on the generator bearing. Allow approximately $\frac{1}{4}$ -inch slack. See *Illustr. 48*.

Removing the Generator Belt

Loosen bolts "A" and nut "B" (*Illustr. 48A*), move the generator in toward the engine and remove the belt from the generator pulley. Loosen fan spindle "C" and slide the fan and hub assembly to the bottom of the groove in the fan bracket. Slip the generator belt through the fan belt and work it up over the fan blades.

Replacing the Generator Belt

Replace the generator belt when it becomes soaked with grease or badly worn.

When replacing the belt, reverse the procedure outlined under "Removing the Generator Belt." Adjust the fan belt and generator belt as described on page 48.

Cleaning the Generator Commutator

If the commutator is dirty or slightly grooved, it can be polished by placing a piece of No. 00 sandpaper on the commutator while the armature is slowly revolving. See *Illustr. 60*. Never use emery or carborundum cloth. Blow all dust from the commutator after the polishing operation is finished.

If the commutator is badly worn, rough or out-of-round, it is advisable to take the unit to your International Harvester dealer and have the commutator reconditioned.

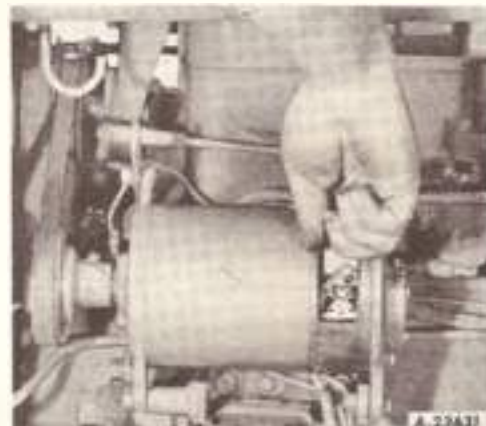

Illustr. 60

Cleaning the generator commutator

Generator Lubrication

Follow the lubricating instructions for the generator as outlined in the Lubrication Guide. Do not lubricate excessively, since excessive oiling may cause the oil and grease to gum on the commutator, and will result in a reduction of the generator output and increased commutator and brush wear.

Never oil the commutator or lubricate the generator while it is in operation.

Cranking Motor

The cranking motor is mounted on the right side of the clutch housing.

At regular intervals, remove the cranking motor cover hand and inspect the commutator.

Cleaning the Cranking Motor Commutator

To clean the commutator, pull out cable "A" (Illustr. 52) or cable "B" (Illustr. 54B) from the center socket on the distributor cap. Remove the cranking motor cover hand. Depress the starting switch by pulling back on the starting switch lever and, with the cranking motor operating, insert a piece of No. 00 sandpaper over the commutator to clean off dirt and discoloration. See Illustr. 61.

Never use emery or carborundum cloth. Always blow all dust from the commutator compartment after cleaning.

Cranking Motor Lubrication

Every six months or after every 500 hours of

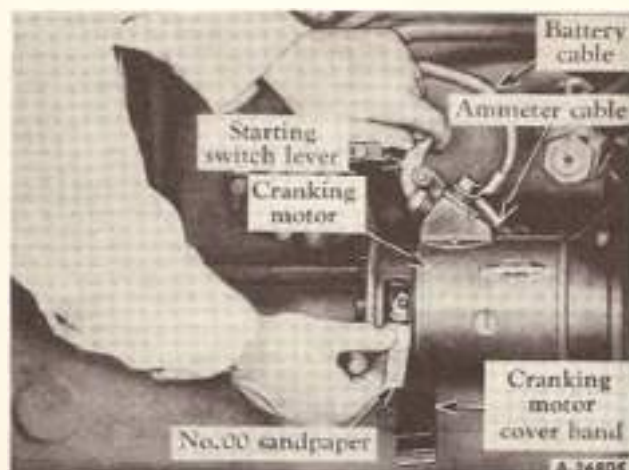

Illustr. 61

Cleaning the cranking motor commutator.

operation, whichever occurs first, put a few drops of SAE-20 oil in the cranking motor oil cup. Also put a few drops of SAE-20 oil on the bushing at the drive end whenever the motor is removed for service.

Removing the Cranking Motor

1. Disconnect the ground cable from the battery.
2. Remove the battery cable and the ammeter cable from the terminal on the cranking motor switch. See Illustr. 62.
3. Remove the two cap screws which hold the cranking motor to the clutch housing and remove the complete cranking motor.

To install the cranking motor, reverse the removal procedures.

MAINTENANCE

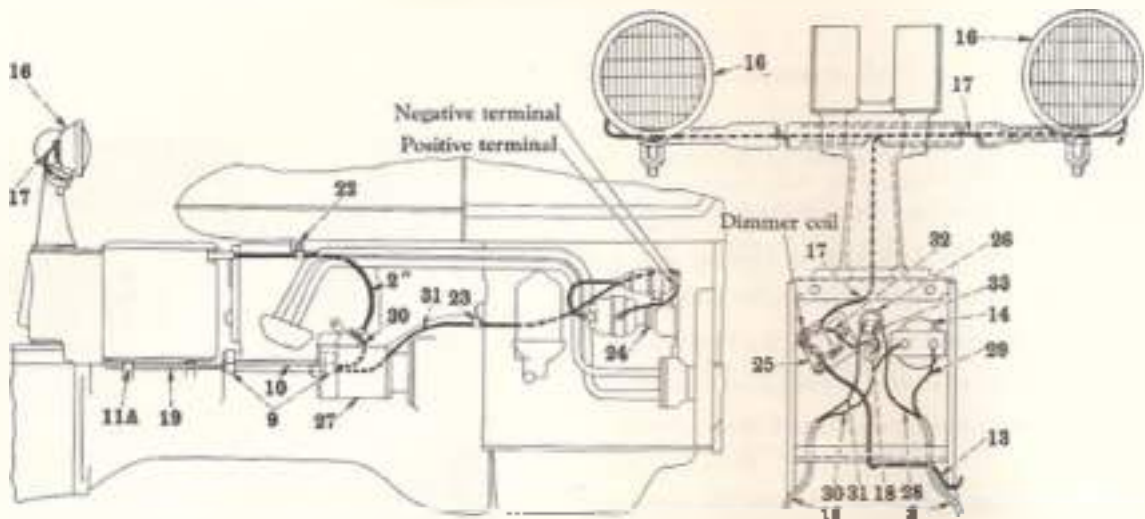

Right side view showing cranking motor, and battery ignition unit connections

View showing lighting switch, ignition switch, fuse housing, ammeter, and headlight connections



Battery connections

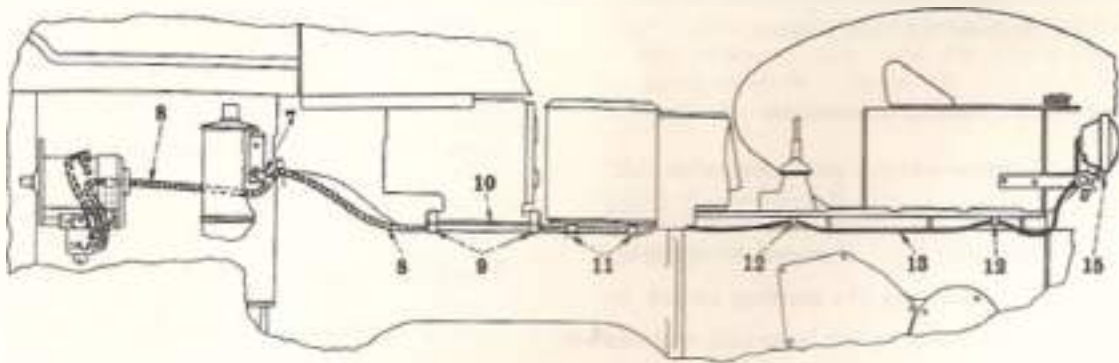

Left side view showing generator, regulator, and rear light connections

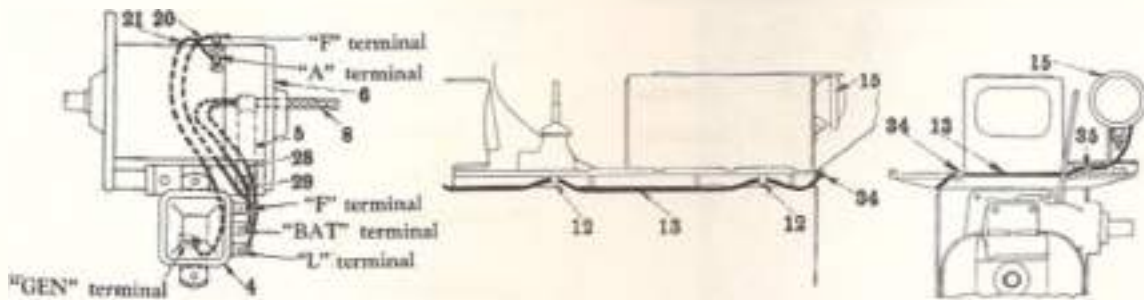

Generator and regulator connections

Rear light mounting on tractor with Fast-Hitch

8.7371

Sheet 62

Wiring diagrams for starting and lighting on tractors with battery ignition.

MAINTENANCE

Index to reference numbers shown in illustration on opposite page

Ref. No.	Description	Ref. No.	Description
1	Battery	19	Cable—ignition and lighting
2	Cable—battery to cranking motor	20	Cable—regulator "E" terminal to generator "F" terminal
3	Cable—battery-to-ground.	21	Cable—regulator "GEN" terminal to generator "A" terminal
4	Voltage regulator	22	Clip on fuel tank rear mounting bolt
5	Clip on generator bracket rear bolt	23	Clip on clutch housing bolt
6	Generator	24	Battery ignition unit
7	Clip on lower air cleaner mounting bolt	25	Lighting switch
8	Cable harness	26	Battery ignition switch
9	Clip on Torch-Control cylinder block mounting bolt	27	Cranking motor
10	Cable harness shield	28	Cable—ignition switch to regulator "E" terminal (natural with green cross tracers)
11	Cable harness supports on battery hold-down bolts (left side)	29	Cable—regulator "BAT" terminal to ammeter (natural with black and red cross tracers)
11A	Clip on battery box rear hold-down bolt (right side)	30	Cable—ammeter to cranking motor
12	Clip on underside of rear frame cover	31	Cable—ignition switch to coil
13	Cable—switch to rear light	32	Cable—fuse housing to lighting switch
14	Ammeter	33	Cable—fuse housing to ignition switch
15	Rear light	34	Clip on rear frame cover left-hand mounting bolt
16	Headlight	35	Clip on belt pulley guard left-hand mounting bolt
17	Headlight harness		
18	Fuse housing		

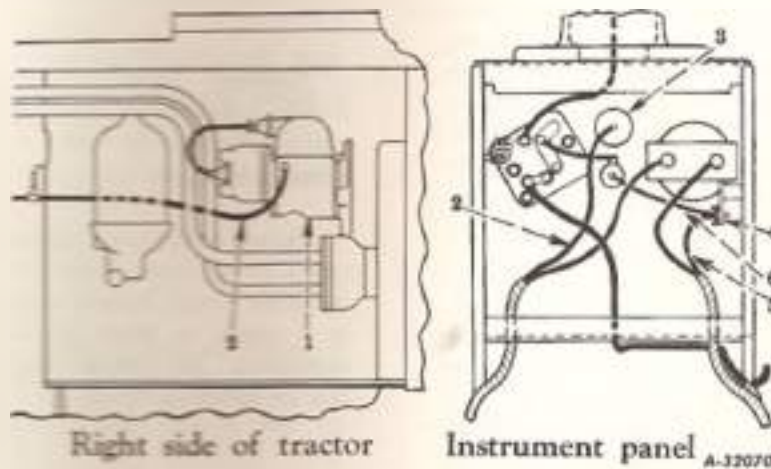

Illustr. 63

Wiring diagram for tractors equipped with magneto.

Starting and Lighting (Magneto Ignition)

Starting and lighting equipment on tractors equipped with magneto is the same as for tractors with battery ignition except as shown in the table at the right and in *Illustr. 63*.

Use *Illustr. 62 and 63* and both tables on this page as a guide to the wiring and electrical work.

Index to reference numbers shown in *Illustr. 63*

Ref. No.	Description
1	Magneto
2	Cable—ignition switch to magneto
3	Magneto ignition switch
4	Junction block
5	Cable—junction block to regulator "E" terminal
6	Cable—fuse housing to junction block

MAINTENANCE

Storage Battery

Electrical energy, obtained through chemical action, is stored in the battery to be used for starting the engine and for furnishing electric lighting. It is not the source of electricity but only a storage reservoir for use when the generator is not running. In starting, for instance, the battery supplies the energy; but as soon as the engine starts, the generator output begins to replace the electricity taken from the battery.

You will receive maximum satisfactory service from your battery by closely following a few simple precautions and service operations.

A registration card is furnished with the battery. The purchaser of a new battery should take the card to the International Harvester dealer for registration.

Complete instructions for moist, uncharged batteries (used for export) are included with the battery.



Illust 64

Taking a hydrometer reading of the electrolyte in the battery.

Cleaning and Servicing the Battery

Battery cable terminals must be kept clean and tight. Use hot water for cleaning the top of the battery. Brighten the terminal contact surface with wire wool and reassemble. Be sure the terminals are clamped tightly and that the battery is fastened securely in the battery box. Replace unserviceable cables. Keep the vent holes in the battery filler caps open.

Liquid Level

The electrolyte (acid and water) in each cell should be at star level at all times to prevent battery failure. When the electrolyte is below this level, pure, distilled water should be added. If your battery is equipped with automatic liquid leveling devices, follow the directions furnished with the battery or consult your International Harvester dealer. Never use hydrant water or any water which has been in a metal container. Keep pure, distilled water on hand in a glass jar for battery use only. Use a clean syringe when adding water and be careful not to allow dirt or corrosive salts to enter the cells.

Acid or electrolyte should never be added except by a skilled batteryman. Under no circumstances add any special battery "dopes," solutions or powders.

Caution! Electric storage batteries give off highly inflammable hydrogen gas when charging and continue to do so for some time after receiving a steady charge.

Do not under any circumstances allow an electric spark or an open flame near the battery. Do not lay tools across battery terminals as this may result in a spark or short circuit which may cause an explosion. Be careful to avoid spilling any electrolyte on hands or clothing.

Specific Gravity

The specific gravity of the electrolyte indicates the relative condition of the battery charge and warns when it may be necessary to recharge the battery.

Inspect the battery once every two weeks to maintain the correct specific gravity. The specific gravity of a fully charged battery is 1.255 to 1.280 corrected to +80° F (liquid temperature). A specific gravity reading of at least 1.230 corrected to +80° F, should be maintained. Never allow the battery to fall below 1.230.

The specific gravity reading will vary with the temperature of the electrolyte. Four readings taken at any temperature other than +80° F., a temperature correction must be applied. This is done by adding .004 specific gravity for every 10° above +80° F., and by subtracting .004 specific gravity for every 10° below +80° F.

Example No. 1

Hydrometer reading.....1.270
 Electrolyte temperature.....+20°F.
 Subtract .024 Sp. Gr.(.004 x 6)
 Corrected Sp. Gr. is.....1.246

Example No. 2

Hydrometer reading.....1.255
 Electrolyte temperature.....+100°F.
 Add .008 Sp. Gr.(.004 x 2)
 Corrected Sp. Gr. is.....1.263

Use an accurate hydrometer when testing for specific gravity. Readings should not be taken immediately after adding water.

All cells should show approximately the same specific gravity reading. Wide variations indicate something is wrong.

For dependable battery service, see your International Harvester dealer.

Battery Voltage

With the battery fully charged and on charge at the normal rate, the average cell voltage at +80° F. ranges between 2.5 and 2.7 volts; at +100° F., between 2.4 and 2.6 volts.

Cold Weather Operation

It is especially important to keep the battery at full charge for cold weather operation. Add water to the battery in freezing temperatures only when the tractor is to operate for several hours, to thoroughly mix the water and the electrolyte, or damage to the battery will result from the water freezing.

The electrolyte of a battery in various stages of charge will start to freeze at temperatures indicated in the table.

Specific Gravity (corrected to +80° F.)	Freezing Temperature (degrees Fahrenheit)
1.230—1½ charge.....	-62° F.
1.180.....	-16° F.
1.130.....	+ 1° F.
1.080.....	+19° F.

The temperatures shown in the table indicate the approximate points at which the first ice crystals begin to appear in the solution. The solution does not freeze solid until a lower temperature is reached. A battery three-fourths charged is in no danger of damage from freezing. Therefore, keep the battery better than three-fourths charged, especially during winter weather.

If your tractor is not to be operated for some time during the winter months, it is advisable to remove the battery and store it in a cool, dry place above freezing (+32° F.). Place the battery on a rack or bench.

Check the battery at least once a month for water level and specific gravity. If the battery shows need of charging it should be given immediate attention. Keeping the battery fully charged not only adds to its life but makes it available for instant use when needed.

Before working on any part of the electrical system, disconnect the battery-to-ground cable. See *Illustr. 63*.

Do not reconnect this cable until all electrical work has been completed. This will prevent shorting and causing damage to any of the electrical units.



Illustr. 65
Battery and cables.

MAINTENANCE

Valve Clearance Adjustment

Check the valve clearance after every 400 hours of operation and adjust the clearance if necessary. A clearance of .014 inch, measured when the valves are closed and the engine is warm, is necessary between the end of the valve levers and the valve stems.

When the exhaust valves are equipped with positive-action valve rotators, check the valve clearance after 50 hours of operation, and after every 120 hours thereafter until the clearance remains the same between two checks.

The loss of valve lash is due to the valve seating in the head without the accompanying build-up of deposits as experienced with standard (non-rotating) valves.

Adjusting the Clearance

1. To safeguard against accidentally starting the engine when checking the valve clearance, remove distributor-to-coil cable "A" from the socket on the coil. See *Illust. 52*. (On tractors equipped with magnets, remove cable "B" from the coil cover. See *Illust. 54B*.)

2. Remove the valve housing.

3. Remove the spark plug from the No. 1 cylinder (the cylinder next to the radiator).

Place your thumb over the spark plug opening and slowly crank the engine until an outward pressure is felt. Pressure indicates the No. 1 piston is moving toward the upper dead center of the compression stroke.

Continue cranking slowly until the DC/1-4 mark on the flywheel is in line with the pointer on the clutch housing cover. The timing pointer can be seen by removing the clutch housing handhole cover. See *Illusts. 55A and 59A*. Both valves are now closed on the compression stroke of the No. 1 cylinder.

4. Loosen the lock nut and adjust the screw in the valve lever so the gauge slips snugly between the end of the valve lever and the valve stem. See *Illust. 66*.

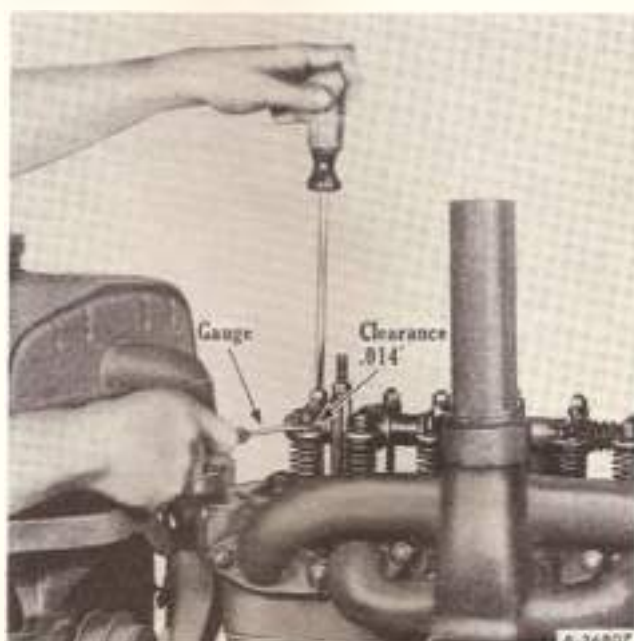

Illust. 66

Gauging the valve levers with a feeler gauge

5. Tighten the lock nut and recheck the clearance.

6. Crank the engine one-half revolution at a time and check the clearance of each cylinder's valves and adjust if necessary. Do this on each set of cylinder valves in succession according to the firing order of the engine, which is 1, 3, 4, 2.

7. Replace the valve housing. Check to see that the valve housing gasket makes an airtight seal with the cylinder head. Use a new gasket if necessary.

8. Replace distributor-to-coil cable "A" (*Illust. 52*) or magneto cable "B" (*Illust. 54B*) into the socket from which it was removed.

Important! Be accurate—use a feeler gauge for checking the valve clearance.

Minor Engine Service Operations

Cylinder Head Gasket

For most satisfactory results in tightening the cylinder head after installing the cylinder head gasket, tighten down all nuts fairly snug, starting with the row in the center, then going to the others. Retighten in the same order, giving each nut a small part of a turn at a time. Continue this until all nuts are tight. Do not screw one nut down perfectly tight and then go to the next as you will not obtain an even pressure on the gasket in this manner.

After replacing the cylinder head, it is necessary to insure against leaks by retightening the stud nuts after the engine has been operating and the water

jacket has become thoroughly heated. To properly tighten the nuts the valve rocker shaft assembly must be raised.

Caution! Be sure to adjust the valve taper clearance after the last tightening of the cylinder head stud nuts. See "Valve Clearance Adjustment."

Crankshaft Bearings, Pistons and Rings

We cannot impress too strongly the necessity of having your International Harvester dealer do the work of replacing the connecting-rod bearings, crankshaft bearings, pistons and rings, and grinding the valves.

Brakes

Note: Movement by hand at top of rear frame cover

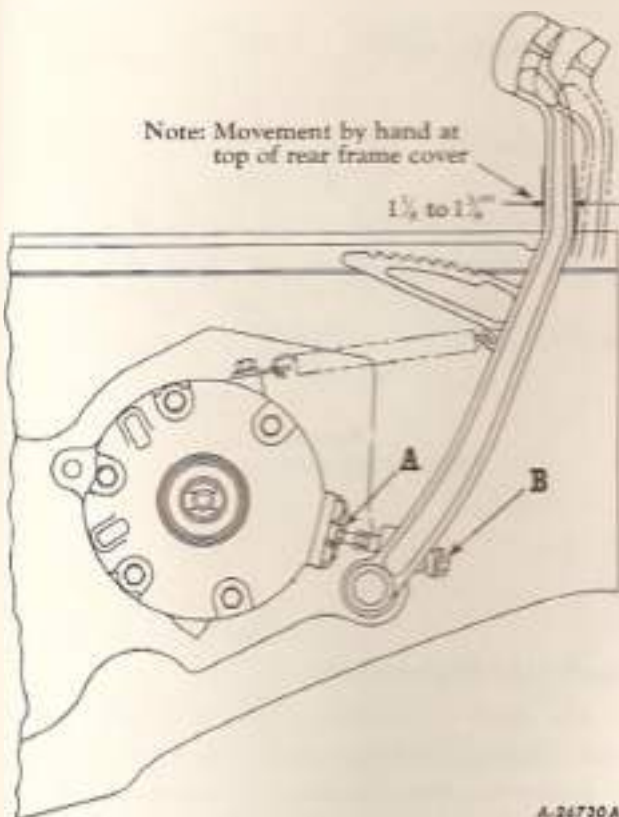

Illustr. 67
Brake pedal adjustment.

This tractor is equipped with mechanical disc-type brakes. The brakes are controlled by foot pedals which can be operated individually or simultaneously when locked together.

Caution Always lock the brake pedals together when traveling in high gear.

The brakes should not drag and should not have an excessive free movement of the pedals before they take hold. The pedals should have a free movement of $1\frac{1}{8}$ to $1\frac{3}{8}$ inches (the measurement to be taken between the points of contact of the brake pedals with the top of the rear frame cover), or just enough movement so that when a slight pressure is applied on the brake pedals, the brake lock can be dropped into the first notch in the rack on the left brake pedal. See Illustr. 67A.

Adjustment

Adjust the free pedal travel of the right brake pedal first, as follows:

Loosen lock nut "A" (Illustr. 67), then turn brake operating rod "B" until the correct free pedal travel

is obtained. Then adjust the free pedal travel of the left brake pedal in the same manner by adjusting the brake operating rod at the left brake housing.

To obtain equalization of both brakes it is very important that both brake pedals have the same amount of free movement. A definite way to check the equalization of the brakes is to jack up both rear wheels so they will turn freely, block the tractor securely and latch the brake pedals together; then start the engine. Shift the gears to either third or fourth speed and engage the clutch; while the wheels are turning, apply the brakes. Application of the brakes should slow down both wheels at the same time and also tend to reduce the speed of the engine. If one wheel stops and the other one continues to revolve when the brakes are applied, loosen the adjustment on the wheel that stops just enough so both wheels stop simultaneously when the brakes are applied.

When the correct adjustment has been made, tighten jam nut "A" (Illustr. 67) on the right and left operating rods.

If the brake operating rod assembly has been disassembled for any reason, the brake operating rod spring should be preloaded $1\frac{1}{8}$ inch as shown in Illustr. 68.

To preload the spring, place the head of the operating rod in a vise. Assemble the plain washer, spring and ball on the operating rod with the flat surface of the ball against the spring. Then assemble the spacer and the first of the three jam nuts.

Continued on next page.

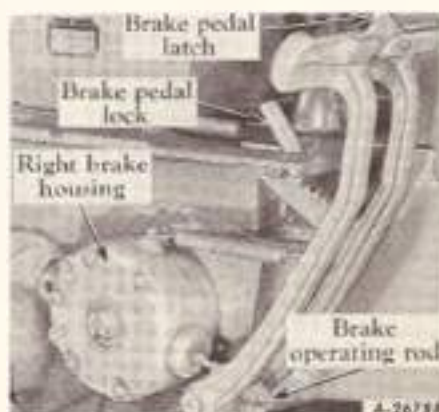

Illustr. 67A
Brake pedals.

Adjustment—Continued

Turn this nut on the operating rod up against the spacer until the correct preload dimension is obtained (the measurement to be taken between the plain flat washer and the flat side of the operating rod ball).

Turn the second jam nut up on the operating rod and tighten it against the first nut to lock it in place.

The third jam nut is used to adjust the brake pedal free travel.

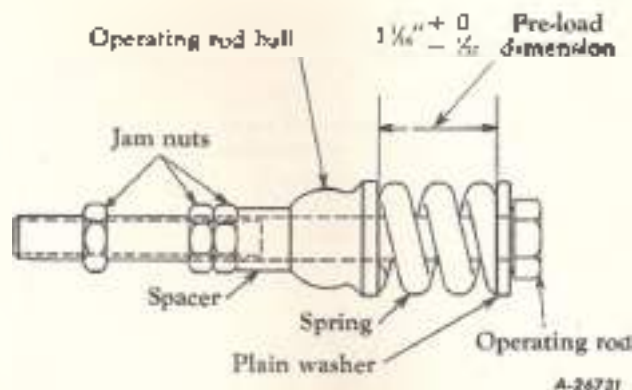

Illustr. 68
Brake operating rod assembly

Engine Clutch

This engine is equipped with either a "Rockford" or "Auburn" clutch; both clutches are spring-loaded clutches and each have a nine-inch single plate and a dry disc. You can identify which type is in your tractor by counting the number of pressure springs. The "Rockford" clutch has six pressure springs, while the "Auburn" has three springs. See *Illustr. 68A*.

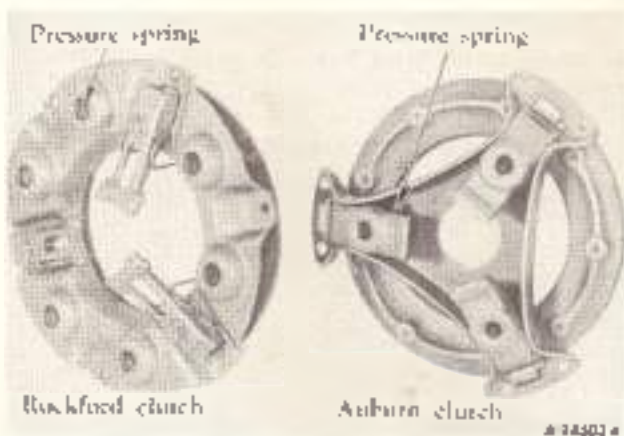

Illustr. 68A
Types of clutches.

Care of the Engine Clutch

The clutch is so designed that it requires minimum attention. Lubricate the clutch release bearing retainer after every 120 hours of operation and the clutch release bearing after every 1,000 hours of operation, or at least once a year as instructed in the "Lubrication Guide" on pages 39 and 41. Do not overlubricate.

Clutch Clearance

It is very important that a clearance of $\frac{3}{16}$ inch be maintained between the clutch release bearing and the clutch release levers. In order to maintain this clearance, the clutch pedal should have a free movement of $1\frac{1}{8}$ inches from the stop on the transmission cover when the clutch is fully engaged. See *Illustrs. 69 and 69B*. As the clutch wears, this free movement decreases and adjustment should be made. The clutch may be badly damaged unless a free movement of the foot pedal is maintained.

The correct free movement can easily be maintained by adjusting the length of clutch operating rod "B". See *Illustr. 69B*.

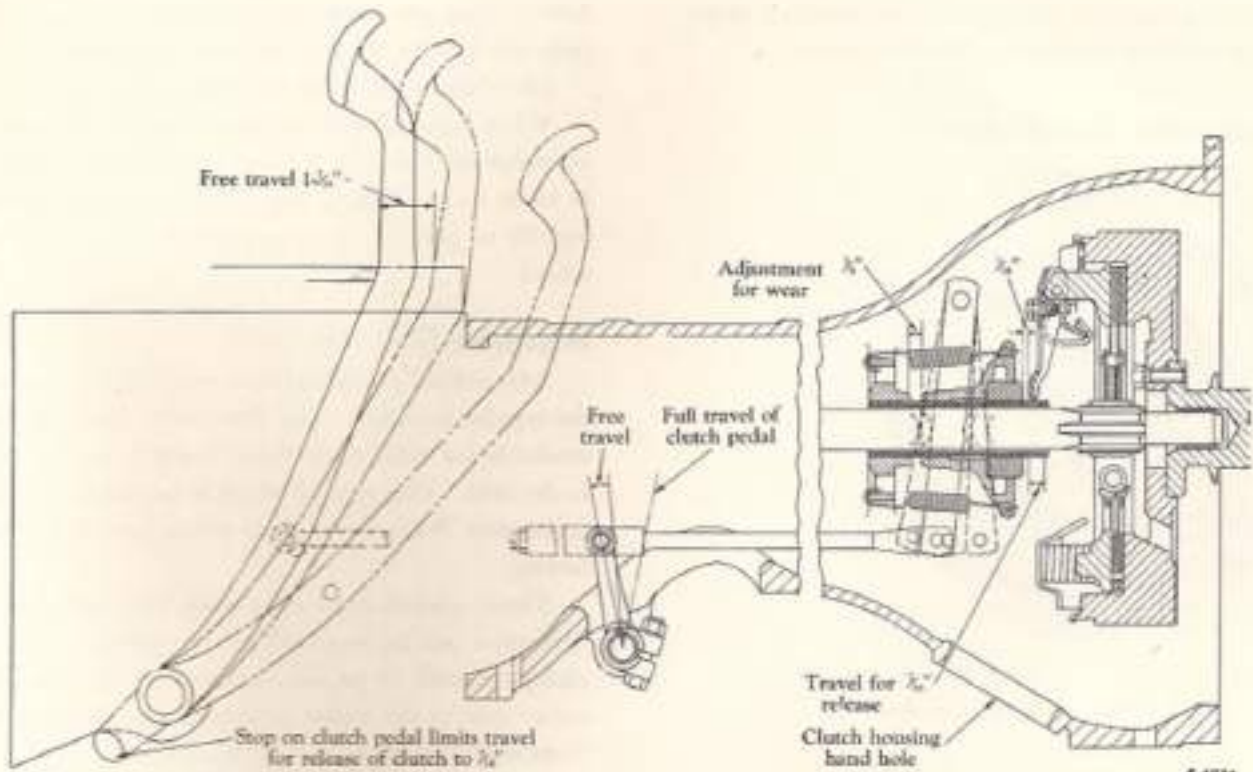

8-4078

Illust. 69

Clutch and connections.

To adjust the length of the clutch pedal rod, loosen nut "A," remove clevis pin "B," and turn clevis "C" until a correct free movement of $1\frac{3}{8}$ inches is obtained; then replace the clevis pin and tighten lock nut "A." See Illust. 69A. This will provide a $\frac{3}{16}$ -inch clearance between the clutch fingers and the release bearing. See Illust. 69.

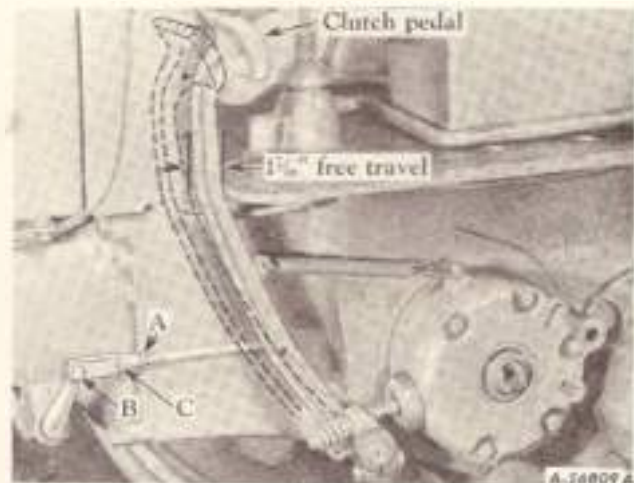

A-26809 A

Illust. 69B

Clutch pedal free movement



A-26808

Illust. 69A

Clutch housing

MAINTENANCE

Front Wheels

Front wheels are provided with mounting holes for the addition of cast-iron wheel weights.

Nonadjustable Front Wheels

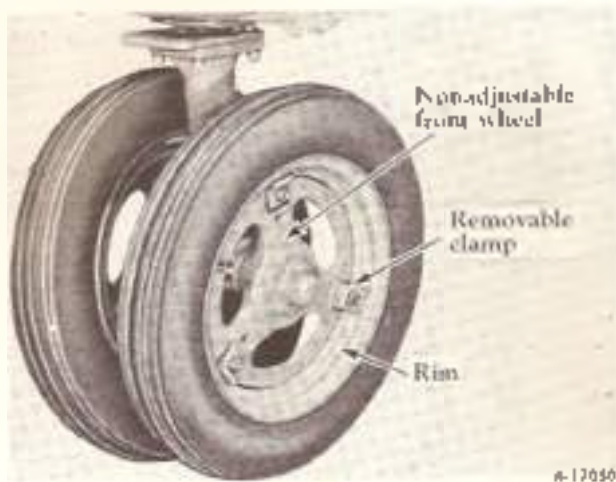

Illustr. 70

Nonadjustable front wheels

The nonadjustable front wheels regularly furnished have demountable steel rims for 4.00-15 or

5.00-15 four-ply tractor-type pneumatic tires. The rims are held in place by removable clamps.

To lubricate the front wheels, see page 35.

When assembling the front wheel rim, be sure to assemble the clamp in the correct position as shown in *Illustr. 70A*. Tighten the clamp bolts securely and equally to prevent misalignment of the rim on the wheel.

Adjustable Front Wheels

Adjustable front wheels are available for use with the regular front axle. See *Illustr. 70B*. They are also available for Adjustable Wide front Axles installed in the field. This type of wheel is furnished with the Adjustable Wide Front Axle when installed at the factory.

These wheels have rims with attached clamps. The rims can be mounted on the wheels with the clamps turned in or out and can be mounted on either side of the wheel to increase or decrease the front wheel tread.

When the adjustable wheels are used with the regular front axle (*Illustr. 70B*), three different tread positions of 6 $\frac{3}{4}$ inches, 9 $\frac{1}{2}$ inches and 12 $\frac{3}{4}$ inches can be obtained as described on the following page.

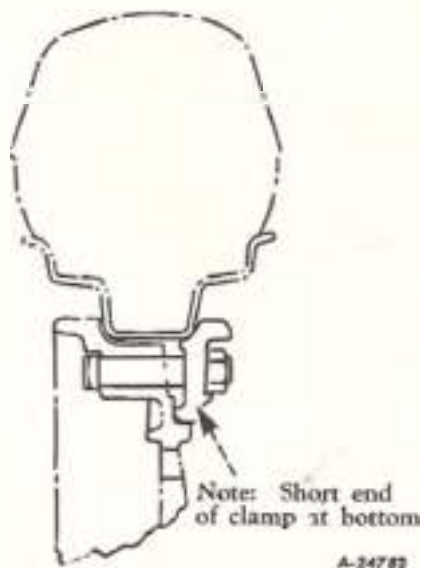

Illustr. 70A

Assembling the front wheel rim clamps on nonadjustable front wheels.



Illustr. 70B

Adjustable front wheels mounted on the regular front axle in the 12 $\frac{3}{4}$ -inch tread position.

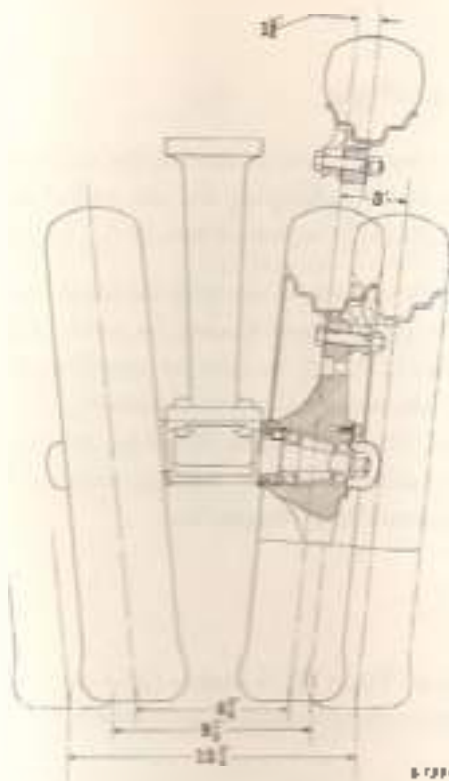

Illustr. 71

Diagrams of tread positions for adjustable front wheels.

1. The 6 3/4-inch tread position is obtained by mounting the clamps on the outside of the wheels with the rims turned in (Position 2). See Illustr. 71A.

2. The 9 1/4-inch tread is obtained by mounting the clamps on the inside of the wheels with the rims turned out (Position 3). See Illustr. 71A.

3. The 12 1/4-inch tread can be obtained by mounting the clamps on the outside of the wheels with the rims turned out (Position 4). See Illustr. 71A.

When the adjustable front wheels are used with the Adjustable Wide Front Axle, various additional tread widths can be obtained by mounting the rims on the wheels in the positions described below. See Illustr. 71A. Also see the tables on page 72.

Position 1 (usable only with 4.00-15 tires)

Rim clamps mounted on the inside face of the wheel with the rim turned in.

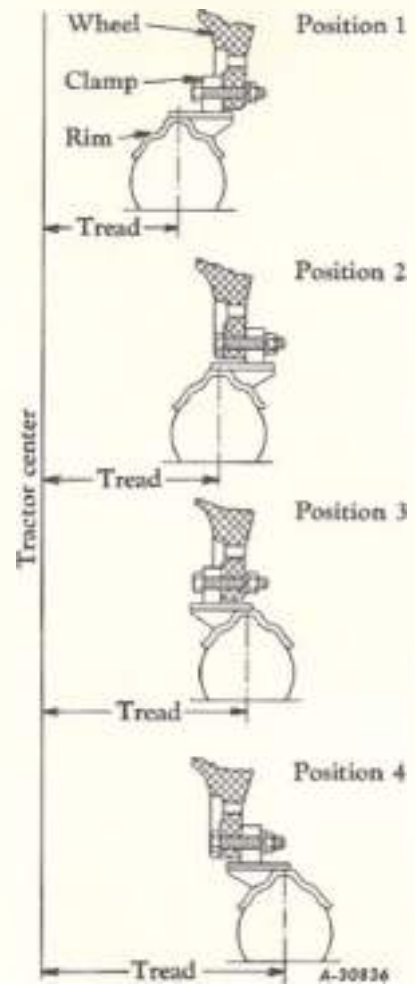

Illustr. 71A

Assembling the front wheel rims with attached clamps.

Position 2

Rim clamps mounted on the outside face of the wheel with the rim turned in.

Position 3

Rim clamps mounted on the inside face of the wheel with the rim turned out.

Position 4

Rim clamps mounted on the outside face of the wheel with the rim turned out.

Note. Do not use Position 4 when the tractor is carrying heavy front-end weight, such as a front-mounted loader, heavy-mounted implements, etc.

Adjustable Wide-Tread Front Axle

Your tractor may be equipped with one of two basic Adjustable Wide-Tread Front Axle Attachments as ordered: one provides a tread range of 56 to 89½ inches; the other, a tread range of 50 to 83½ inches. Many intermediate settings between these limits are possible.

The above figures apply when using 4.00-15 tires having variable-tread-type rims and wheels. If nonadjustable wheels or larger tires are used, the tread range is more limited. Various tread settings,

which can be obtained by moving the axle extensions in or out and by changing the rim and clamp positions on the wheels, are shown in the tables.

Inner Position 1 of the variable-tread rim on the adjustable front wheel cannot be used with a tire larger than 4.00-15 because of interference of the tire with the tie rod and axle extension. Do not use maximum offset Position 4 when the tractor is carrying added front-end weight, such as loaders, heavy-mounted implements, etc.

Adjustable Wide-Tread Front Axle Attachment with Tread Range of 50 to 83½ Inches (in 4-Inch Intervals)

Nondadjustable Wheels53¼ to 77¼			
		4.00-15 Tires	5.00-15 Tires	6.50-16 Tires
Variable Tread Wheels	Rim Position 1	50 to 74	Not usable	Not usable
	Rim Position 2	53¼ to 77¼	53¼ to 77¼	54 to 78
	Rim Position 3	56 to 80	56 to 80	54¼ to 78½
	Rim Position 4	59¼ to 83¼	59¼ to 83¼	57¼ to 81¼

Adjustable Wide-Tread Front Axle Attachment with Tread Range of 56 to 89½ Inches (in 4-Inch Intervals)

Nonadjustable Wheels59¼ to 83¼			
		4.00-15 Tires	5.00-15 Tires	6.50-16 Tires
Variable Tread Wheels	Rim Position 1	56 to 80	Not usable	Not usable
	Rim Position 2	59¼ to 83¼	59¼ to 83¼	60 to 84
	Rim Position 3	62 to 86	62 to 86	60¼ to 84½
	Rim Position 4	65¼ to 89¼	65¼ to 89¼	63¼ to 87¼

MAINTENANCE

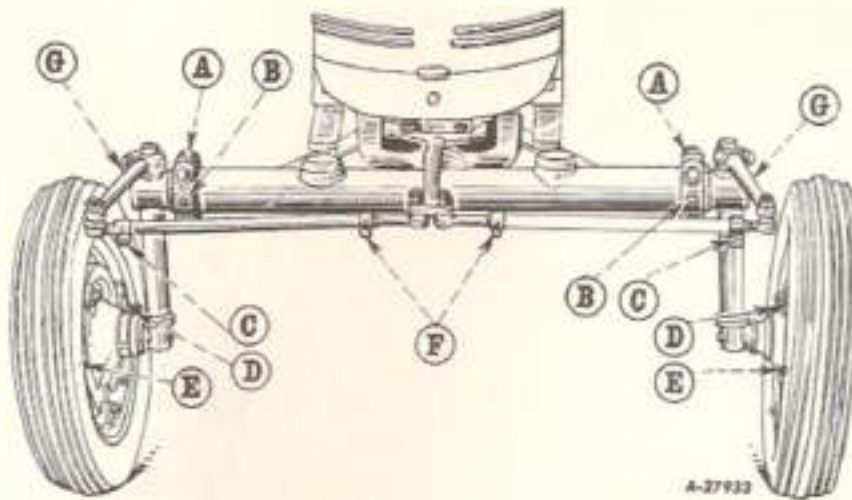

Illust. 73

Adjustable Wide-Tread Front Axle.

Note: The 50-inch tread position cannot be obtained on tractors equipped with 5.00-15 tires. The 6.50-16 tire can be used only in maximum tread rim Position 4. See *Illust. 71A*. This tire is for flotation purposes only and is not to be used for heavy superimposed front-end loads. The wheel base of the tractors equipped with the Adjustable Wide-Tread Front Axle is 91 $\frac{1}{8}$ inches. The ground clearance under the front axle is 23 $\frac{1}{8}$ inches.

Adjusting the Tread Widths

1. Loosen the bolts holding axle extension clamps "A." See *Illust. 73*.
2. Pull out the cotter pins and remove axle extension clamp pins "B." Remove the bolts from tie rod clamps "C."
3. Pull the axle extensions out an equal distance on both sides to the desired tread position and move the tie rods as correspond.
4. Replace axle extension clamp pins "B" in the

holes selected and tighten the clamps. Also replace and tighten the bolts in the tie rod clamps.

Be sure to make the arm adjustments equal.

Adjusting the Toe-In

The front wheels should have $\frac{1}{8}$ -inch to $\frac{1}{4}$ -inch toe-in ($\frac{1}{8}$ inch to $\frac{1}{4}$ inch closer in front than in the rear). Measure the distance between two points "D" and two points "E." See *Illust. 73*. Points "D" and "E" must be at the outer edges of the rims and at the same height from the ground as the hub caps.

To adjust the toe-in, disconnect steering knuckle arms "G", loosen tie rod clamp cap screws "C" and turn the tie rod ends in or out as required. Be sure to make the arm adjustments equal.

Adjustments also can be made without disconnecting the tie rods from the steering knuckle arms by removing bolts "E" from the tie rod clamps and loosening the bolts in tie rod clamps "C". Then turn the tie rod tubes clockwise or counterclockwise until the correct toe-in is obtained.

MAINTENANCE

Rear Wheels

The rear wheels are cast iron and have demountable steel rims for 8-36, 9-36 or 10-36 four-ply tractor-type, agricultural-tread tires as ordered with the tractor.

The rear wheel tread can be varied from 48 to 71 inches with the wheels dished in (rim clamps turned in) or from 57 to 80 inches with the wheels dished out (rim clamps turned out).

These adjustments can be made by moving the wheels in or out on the axles, and by reversing the wheels on the axles. When reversing the wheels on the axles, make sure that the tires rotate in the direction shown by the arrow on the side of the tires. This will mean changing the wheels from one side of the tractor to the other unless the tires are removed from the rims.

Rear wheels are provided with mounting holes for the addition of cast-iron wheel weights.



Illust. 74

Rear wheel dished out

Pneumatic Tires

Observe the following instructions and recommendations in order to secure maximum life and efficient service from the pneumatic tires.

Inflation

Keep the pneumatic tires properly inflated to the pressures shown in the table on page 75. Underinflation will damage the tire cord body and may cause the tire to slip on the rim and tear out the tube valve stem. Overinflation results in excessive slippage, causing rapid tire wear.

Check the air pressure once a week with an accurate low-pressure gauge having one-pound graduations. Do not allow the air pressure to drop below the recommendations.

Always see that tire valve caps are in place and are screwed tightly. The caps prevent the loss of air through the valve core, and also prevent loose soil, mud, gravel, snow, and ice from entering and damaging the valve core and air chamber in the tires.

Tires can be inflated with a pressure pump, hand pump, or a spark plug pump. Spark plug pumps can be purchased from International Harvester dealers.

Using the Spark Plug Pump

Note: Do not use a diesel engine as the source of power.

Remove one of the spark plugs from the tractor engine, or any carbureted engine having the correct spark plug thread size, and replace with pumping element "A." See *Illust. 74A*. Attach one end "B" of the pump hose to the pumping element, and other end "C" to the valve stem of the tire to be inflated.

Start the engine and run it at low speed for maximum efficiency.

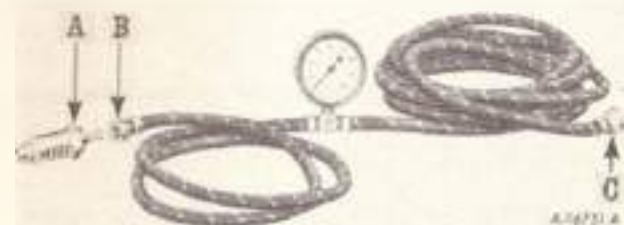

Illust. 74A

Engine tire pump with 16-foot hose and air gauge.

MAINTENANCE

Operating Pressure for Low-Pressure Traction Tires

Caution! Upon receiving your tractor, immediately adjust the air pressure in tires as indicated below.

Front and Rear Tires	Lb. Per Sq. In.	KG/CM ²
Front (All Sizes)		
A—4-ply tires.....	28	1.97
B—6-ply tires.....	36	2.53
Rear		
C—Minimum inflation pressure, 4 and 6-ply tires.....	12	.84
D—When plowing, increase pressure on tire on furrow wheel by.....	4	.28
E—When special heavy wheels are used, or heavy implements such as corn pickers, budgers, etc., are carried on the tractor, inflation pressure must be increased. See Tire and Rim Association schedule or contact your International Harvester dealer or tire dealer.		
F—Maximum inflation pressure, 4-ply tires.....	16	1.12
G—Maximum inflation pressure, 6-ply tires, all sizes.....	24	1.68

Shipping Tractors Equipped with Pneumatic Tires

When tractors are transported on a carrier, such as a railroad car or trailer, inflation pressures should be as follows to make possible rigid blocking and to prevent bouncing:

All 4-ply front tires.....	30 lb.
All 6-ply front tires.....	36 lb.
All rear tires.....	30 lb.

Important! Deflate the tires to the correct operating pressure before the tractor is transported under its own power, towed, put into service, or placed in storage for any length of time; otherwise, the rubber will check or crack.

Maximum speed for highway use should not exceed 20 miles per hour. For farming operations a maximum speed of 10 miles per hour is recommended.

Mounting Tires on the Rim

After mounting a new or old tire on the rim, inflate it to 30-pound pressure to seat the tire bead on the rim flange and to prevent the tire from creeping and shearing off the valve. Then deflate or inflate the tire to the correct operating pressure.

Traction and Weights

The recommended air pressures are shown in the table. The tractor should not be operated with the tires improperly inflated. To insure the maxi-

mum hours of service, watch the tread lug; if they wear down too fast, immediately add more weight to cut down slippage. Check for high air pressure. Consult your International Harvester dealer for information.

Wheel Weights

The drawbar pull of a tractor can be increased by adding cast-iron weights to the driving wheels, and by the use of liquid in the tire tubes.

The amount of the increase in drawbar pull by the addition of certain definite weights varies with the type of soil. When very heavy weight is required, both liquid and cast-iron weights can be used.

Overloading

Do not overload the tractor tires by mounting implements on the tractor which exceed the load capacity of the size of the tires on the tractor.

After adding weights to the rear wheel, it may be necessary to readjust the height of the drawbar to obtain the correct alignment.

Liquid Weight

Tractor tire tubes can be three-quarters filled with liquid, using clean water for temperatures above freezing (+32° F.). A calcium chloride solution (CaCl₂) is recommended when operating in freezing temperatures.

Putting Liquid into the Tube

Purchase an adapter (Illustr. 75) from an International Harvester dealer. The adapter is equipped with a bleeder for letting out the air displaced by the liquid.

Jack up the tractor and revolve the tire so the valve stem is on top. Remove the valve core housing and screw on the adapter, then attach the water hose to the adapter.

The liquid can be put into the tube from a tank placed at least five feet higher than the tire, or by using a hand force pump, or compressed air and a pressure tank filled with liquid.

Remove the hose and adapter; then replace the valve core housing and inflate the tire to the correct operating pressure.

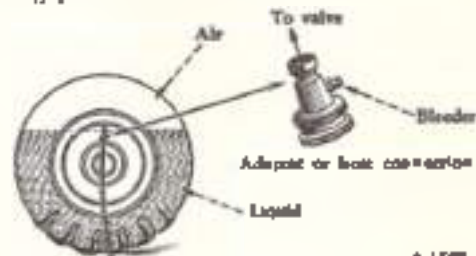

Illustr. 75
Tire three-quarters full of liquid.

Liquid Weight for Freezing Temperatures

Calcium chloride solution, using a 25% mixture, which is approximately 20 pounds of flaked calcium chloride to ten U. S. gallons of water, is recommended when freezing temperatures prevail.

The strength of the solution can be checked with a battery hydrometer. A 25% solution measures approximately 1.225 specific gravity and has a freezing point of -25° F.

Caution: Some calcium chloride flakes have an acid reaction. It is advisable to add one pound of lime to each 100 pounds of calcium chloride used.

When preparing the calcium chloride solution, always pour the water into the container first; then add the correct amount of calcium chloride crystals, stirring the mixture thoroughly. Never pour the water on the calcium chloride flakes. After the solution is mixed, allow it to cool before using.

Valve Stem Mounting Cones

Valve stem mounting cones are furnished with all rear wheel tire tubes having valve stems for inserting liquids; the cones are mounted on the valve stem at the factory.

The purpose of the cone is to hold the valve stem in the valve hole when mounting the tire, particularly when liquid is used in the tire. Without the cone when mounting the tire or inserting the liquid, the valve stem might be pulled into the rim and will cause extra work in again inserting it through the valve hole.

Farmall Touch-Control, Hydraulic Remote Control and Fast-Hitch Systems

The Touch-Control, Hydraulic Remote Control and Fast-Hitch systems are ready to operate whenever the engine is running. You will obtain maximum satisfactory service by closely following a few simple precautions and service operations.

The importance of keeping the systems free of all dirt, grit and other foreign matter cannot be stressed too strongly. Keep the Touch-Control Fluid reservoir, pipe lines and pump as clean as possible at all times. The same care must be given to the cylinder, hose lines and connections when equipped with Hydraulic Remote Control. As an added precaution against the entry of dirt into the system, the reservoir is constructed without an air vent. Sufficient air space is allowed above the fluid level to compensate for the pressure changes occurring during the operation of the system. As a result a small amount of pressure may be found in the reservoir when removing the filler plug to check the fluid level.

Fluid Level

When the tractor is shipped from the factory, the

Care of Tires

Avoid stumps, stones, deep ruts and other hazards. Cuts in tires should be repaired immediately, as neglect decreases tire life. Keep the tires free from oil and grease, as both destroy rubber. After using the tractor for spraying (insect control work), use water to remove any chemicals that may be on the tires.

Tire Protection During Storage

When not in use, store the tractor so the tires are protected from the light. Before storing the tractor, clean the tires thoroughly. Jack up the tractor so the load is off the tires when it is to be out of service for a long period. If not jacked up, inflate the tires at regular intervals. Before driving the tractor, inflate the tires to the correct operating pressures.

Tire Chains

In wet grass or ground conditions, use lug-type chains. The flexing of the tire and the creeping of chains will break the mud loose as the wheel rotates. **Note:** There is a possibility of the tire slipping within the chain; to prevent this, the use of spring-type chain fasteners is recommended.

Static Electricity in Tractors Equipped with Pneumatic Tires Doing Belt Work

Static electricity generated by belt work can be discharged harmlessly by attaching a chain to the tractor and allowing it to touch the ground.

Touch-Control system is filled to the proper level with IH Touch-Control Fluid and it should not require servicing, unless for some reason the system has been disturbed.

If the Touch-Control system should fail to operate in a satisfactory manner or if there are any noticeable leaks in the system, check the fluid level in the reservoir or see your International Harvester dealer.

Never operate the tractor without having sufficient fluid in the reservoir. Insufficient fluid may cause damage to the Touch-Control system.

Before removing the filler plug (*illus. 77A*) for inspection, thoroughly clean the plug and surrounding area of all dirt and grit.

The correct fluid level is to within $\frac{1}{2}$ inch of the bottom of the filler opening. If it is necessary to add fluid, use IH Touch-Control Fluid. It is essential that the fluid be absolutely clean and free of water and foreign matter when placed in the system. Cloudiness of the fluid may indicate the presence of moisture.

MAINTENANCE

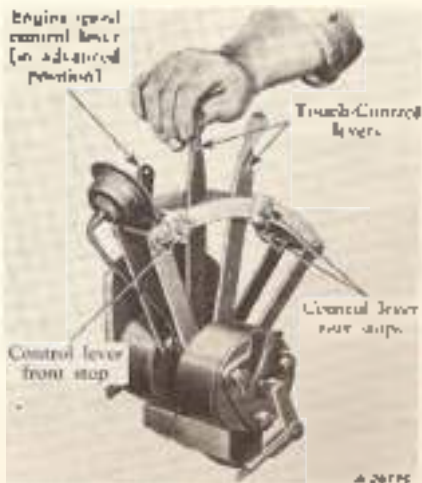

Illustr. 77
Touch-Control levers.

Draining and Filling the Reservoir

When it is necessary to drain and refill the reservoir for any reason, proceed as follows:

1. Wipe off all dirt and grit from the reservoir and filler plug.

2. Remove the filler plug on the left side of the reservoir and the drain plug (Illustr. 77A) and place them in a clean container.

When the fluid has stopped draining, run the engine very briefly to drain the fluid from the pump and connecting pipes.

The refill capacity of the Touch-Control system when drained as instructed above is approximately $6\frac{3}{4}$ U. S. pints. When equipped with Remote Control, the refill capacity from the hydraulic pump to the break-away coupling front half is approximately $8\frac{3}{4}$ U. S. pints. When equipped with a Fast-Hitch Attachment, the refill capacity from the hydraulic pump to the hydraulic cylinder is approximately $9\frac{3}{4}$ U. S. pints.

Note: If it is necessary to flush the system, use only IH Touch-Control Fluid so the necessary lubrication of the pump and control system is maintained without adulteration. Never use kerosene or any other oils.

Continued on next page.

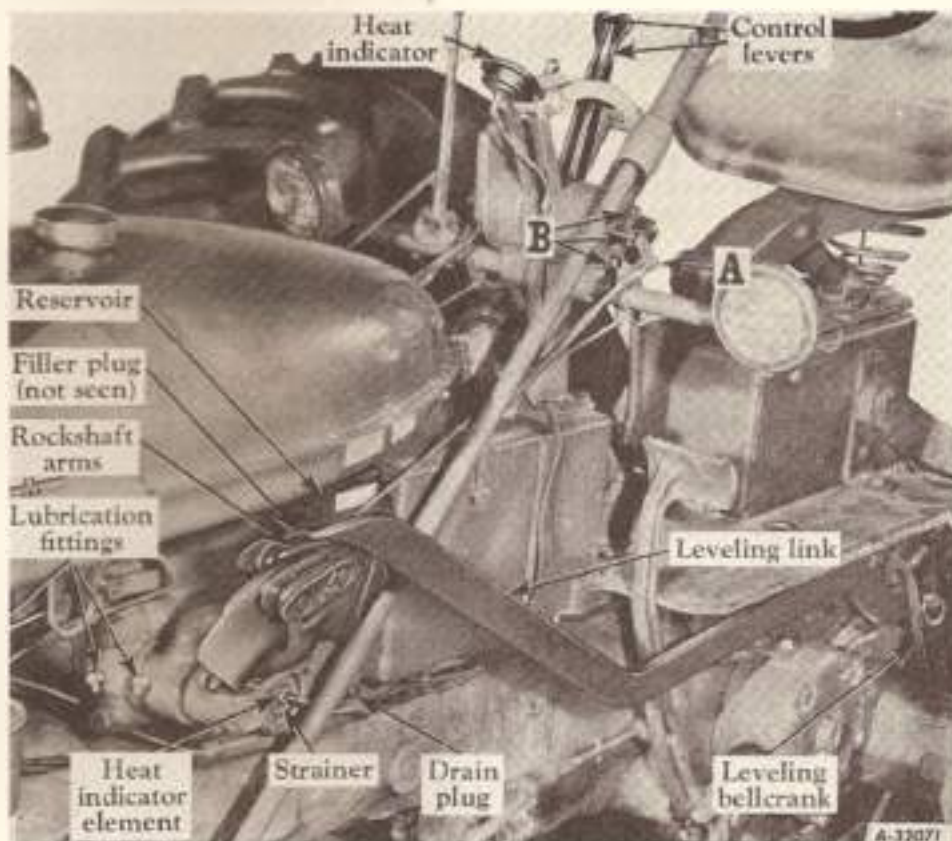

Illustr. 77A
Farmall Touch-Control system.

Draining and Filling the Reservoir

—Continued

3. Remove and clean the cylinder block strainer (Illustr. 77A) whenever the reservoir is drained.

To clean the strainer, remove any of the parts that will interfere with removing the strainer. Remove the leveling link (used with Fast-Hitch) by disconnecting it from the rockshaft arm and the leveling bellcrank. Remove pin "A" (Illustr. 77A) and lower the left Touch-Control rod. Remove three cap screws "B" which hold the steering shaft to the steering shaft support bracket. Set the left Touch-Control lever in a position where the steering shaft can be lifted away from the control lever shaft. This will allow moving the steering wheel and shaft nut to the side. Wipe off all dirt and grit from the cylinder block. Then remove the heat indicator element from the strainer by screwing out the element nut. Now remove the four cap screws which hold the strainer to the cylinder block and pull out the screen. Clean the strainer thoroughly in clean Touch-Control Fluid. Then replace the strainer and make sure that the gasket is in perfect condition. If the gasket is damaged, replace it with a new one. Replace the heat indicator element and tighten the element nut sufficiently to prevent leakage of Touch-Control Fluid.

4. After the system has drained completely, replace the drain plug and fill the reservoir to the filler opening with IH Touch-Control Fluid.

5. Start the tractor engine and operate it at a moderate idle speed. With the filler plug removed, move both Touch-Control levers and the Remote Control lever (when so equipped) back and forth ten or twelve times through their full range of travel. This frees the system of trapped air. Place the control levers in the rearward position (toward the tractor seat). Then, with the Remote Control lever

in the neutral position and the cylinder piston in the retracted position, stop the engine.

6. Add sufficient clean fluid to the reservoir to bring the fluid level to within one-half inch of the bottom of the filler opening. Replace and tighten the filler plug.

7. Replace the previously removed control rod, steering shaft, and bellcrank actuating link (if the tractor is so equipped).

Lubrication

Daily or after every ten hours of operation, lubricate the rockshaft arm and bearings as instructed in the "Lubrication Guide."

Note: Always keep the Touch-Control levers in the rearward position (toward the tractor seat) when the tractor or the Touch-Control system is not being actively used. This places the piston in the retracted position, preventing exposure to any moisture which may have condensed in the leather dust boot.

Air in the System

Make certain that all connections and openings are well sealed. The entire system must be kept tightly sealed at all times, not only to prevent loss of fluid, but also to avoid entrance of air in the inlet end of the system.

Air entering the system interferes with proper lubrication of the moving parts. It causes an increased amount of vibration and an unsteady pressure. Presence of air in the system will be noticed by a noise in the pump or by the pump laboring when operating under high pressure.

Proper filling of the reservoir and working the system during the filling process as previously described will work the air out of the system.

Seat

Seat Adjustment

The hydraulic seat gives the operator the maximum in riding comfort. It can be quickly and easily adjusted to the most comfortable position for the operator.

The seat is quickly adjusted by pulling up on the button located under the seat (Illustr. 78) and moving the seat forward or backward to the most comfortable operating position.

This may be done while the operator is in the seat.



Illustr. 78
Adjusting the seat

MAINTENANCE

Trouble Shooting

Possible Cause	Possible Remedy
Hard to Start	
No gasoline in starting tank or carburetor.....	Fill the tank with gasoline; open the fuel shut-off valve. Check the fuel lines, fuel strainer and carburetor.
Distillate in starting fuel or carburetor.....	Drain the carburetor and use gasoline for starting; see page 14.
Fuel strainer or fuel lines clogged.....	Clean the fuel strainer, check the fuel lines and carburetor.
Impulse coupling inoperative (tractors with magneto).....	Flush with kerosene; see page 55.
Water in gasoline.....	Drain the fuel tank and carburetor. Use new fuel and dry the spark plugs.*
Water in cylinders.....	Check the cylinder head gasket or look for a clogged drain hole in the exhaust manifold or muffler.
Choked improperly. Flooded engine.....	Follow the starting instructions on pages 11 and 12.
Defective ignition or loose wiring.....	Check the wiring, plugs, battery ignition unit or magneto, etc. See pages 51 to 63.
Defective battery or cranking motor.....	Check and service; see pages 61 and 62, or replace.
Spark plugs dirty or improper gap.....	Clean, adjust the gaps to .025 inch, or replace the plugs.
Magneto grounded (tractors with magneto).....	Pull out on the ignition switch. Check for other possible grounds; also see "Magneto" on page 54.
Engine speed control not advanced.....	Advance the lever one-third for starting.
Lack of compression.....	*
Flywheel ring gear teeth broken.....	*
Lubricating oil of too high viscosity.....	Drain and refill with proper lubricant. See the "Lubrication Table" on page 36.
Gears engaged.....	Put the gearshift in the neutral position.
Internal seizure.....	*

Engine Operates Irregularly or Knocks

Engine incorrectly timed.....	Retime. See "Timing the Distributor to the Engine" on pages 33 and 34, or "Timing the Magneto to the Engine" on page 57.
Spark plugs dirty; wrong gap or wrong type.....	Clean, reset the gaps to .023 inch, or replace.
Poor or weak spark.....	Check the battery ignition unit or magneto to see if the spark is good from the coil. Check the breaker points and breaker point opening, spark plugs, and wiring; see page 51.
Carburetor setting incorrect.....	Adjust; see "Carburetor" on pages 43 and 44.
Poor grade fuel or water in fuel.....	Drain and use a good grade of clean fuel.
Engine overheating.....	Check the cooling system and fan belt; adjust the radiator shutter if used; see "Engine Overheat" on page 80.
Operating a cold engine on distillate.....	Warm up the engine on gasoline before changing over to distillate fuel.
Engine valves at fault.....	Check the valve clearance.*
Air leaks around intake manifold.....	Check the gasket and tighten the nuts.
Engine smokes.....	Check the air cleaner oil level. Check the fuel delivery at the carburetor. Check for worn piston and rings.*
Excessive carbon in engine.....	*
Loose piston pin or bearings.....	*
Broken rings or loose pistons.....	*
Worn connecting rod and main bearings.....	*
Governor sticking or needs adjustment.....	*

Lack of Power

Engine speed control lever not advanced.....	Advance the engine speed control lever.
Engine cold or overheated.....	Run the engine until it warms up before putting it under load. Adjust the radiator shutter if used. Check the cooling system.*
Engine overloaded.....	Reduce the load.
Engine knocks excessively.....	Use good fuel; also check the timing.*

*See your International Harvester dealer

MAINTENANCE

Possible Cause

Possible Remedy

Lack of Power—Continued

Governor not working properly.....*	"
Poor compression.....	Service the valves and piston rings.*
Poor fuel or too lean a mixture.....	See "Carburetor" on pages 43 and 44
Fuel lines or strainer obstructed.....	Clean; see page 43.
Fuel tank air vent closed.....	Open the vent in the cap.
Exhaust pipe clogged.....	Clean out.
Air cleaner clogged or air leakage between carburetor and engine.....	Clean the air cleaner as instructed on pages 49 and 50. Tighten the carburetor and manifold mounting nuts.
Oil of too high viscosity in crankcase or air cleaner.....	Drain and refill with proper lubricant. See the "Lubrication Table" on page 36.
Incorrect timing or faulty ignition.....	See "Battery Ignition Unit" (page 51) or "Magneto" (page 57).
Clutch slipping.....	Adjust the free travel of the pedal; see page 68.*
Brakes drag.....	Adjust the brakes; see page 67.
Carburetor intake manifold or cylinder head intake ports restricted by carbon.....	Clean.*

Engine Overheats

Cooling system clogged or limed.....	Clean the system, see page 47.*
Fan belt slipping.....	Adjust or replace the belt; see page 49.
Insufficient water in cooling system.....	Fill the radiator to the proper level; see page 46.
Radiator cores clogged.....	Remove all chaff or dirt from the radiator grille; clean with forced air or water.
Wrong kind of fuel.....	Change to a good grade of gasoline.
Carburetor improperly set.....	See "Carburetor" on page 43.
Timing incorrect.....	Check per "Battery Ignition Unit" (page 53) or "Magneto" (page 57).
Breaker point opening incorrect.....	Adjust the opening per "Battery Ignition Unit" (page 52) or "Magneto" (page 53).
Excess load.....	Reduce the load.
Excess carbon in engine.....	"
Heat indicator defective (distillate engine).....	Replace the heat indicator.*
Radiator shutter closed (if used).....	Open the shutter.

No Oil Pressure, Too High or Too Low

Defective oil pressure indicator.....	Replace.*
Wrong viscosity, diluted or insufficient oil.....	See the "Lubrication Table" (page 36). Check the oil level; if diluted, replace with fresh oil; see the operating instructions.
Broken, loose or plugged oil lines.....	Clean and tighten.*
Low oil level in crankcase.....	Add oil; see the "Lubrication Guide." Check for an oil leak.
Defective or dirty oil pressure regulating valve.....	"
Oil pump strainer clogged or pump not working.....	Clean as instructed on page 33.*
Worn bearings.....	"

Oil Dilution or Uses Too Much Oil

Oil of incorrect viscosity.....	See the "Lubrication Table" on page 36.
Leaks in oil lines or filter or in oil pan plug or gasket.....	Check and tighten.*
Worn piston or oil rings.....	"
Loose connecting rod bearings.....	"
Long engine idling.....	Stop the engine.
Engine overheating or too cold.....	See "Lack of Power" and "Engine Overheats."
Engine speed too high.....	"
Crankcase breather clogged.....	Clean the breather cap as instructed on page 33.

*See your International Harvester dealer.

MAINTENANCE

Possible Cause	Possible Remedy
Using Too Much Fuel	
Fuel mixture too rich. Carburetor out of adjustment.....	Check choke and see "Carburetor" on page 43.
Fuel leaks.....	Tighten or replace the fuel lines or fuel strainer gasket.
Poor grade of fuel.....	Use a good grade of gasoline.
Choke closed.....	Investigate for the choke not operating.
Engine overloaded.....	Reduce the load or shift to a lower speed.
Poor compression.....	*
Faulty ignition.....	See pages 51 to 57.
Engine not operating at proper temperature.....	Check the cooling system. Check the lubricating oil.*
Air cleaner clogged.....	Service the air cleaner; see page 49
Wrong viscosity or amount of lubricating oil.....	See the "Lubrication Table" on page 36, and keep the oil up to the proper level

No Fuel at Carburetor

Fuel low in tank.....	Fill the fuel tank and check the fuel lines.
Air vent hole in fuel tank cap plugged up.....	Clean out the vent hole.
Fuel valve closed or partly open.....	Open the valve; see the starting instructions on page 31 or 34
Dirty or clogged fuel strainer screen or line.....	Clean as instructed on page 43.

Ignition and Electrical

Wrong kind, old, cracked, dirty, or poorly set spark plugs.....	Clean and set the gaps to .023 inch, or replace with new plugs
Loose wiring or improper connections.....	Check the wiring to see that all connections are clean and tight; see pages 51 to 63.
Battery ignition unit or magneto not timed correctly.....	Retime as instructed on page 53 or 57
Distributor cap or rotor or breaker chamber dirty.....	Clean as instructed on page 52 or 56
Breaker points dirty, pitted or improperly set.....	Clean and reset the opening or replace with new points; see page 52 or 55.
Breaker arm stuck, weak or broken spring.....	Check and replace; see page 52 or 55.
Impulse coupling dirty (tractors with magnet).....	Clean and lubricate as instructed on page 55.
Battery defective, low charge or loose connections.....	Recharge, clean and tighten the cable lugs or replace with new; check the ground cable; see page 62.
Cranking motor failure.....	Replace.*
Generator inoperative.....	Clean the commutator, check the brushes; see page 60.*
Voltage regulator or generator relay.....	*
Ammeter inoperative.....	Replace the ammeter.*
Ammeter shows discharge.....	Check the battery and generator; check the drive belts and wiring.
Lights will not burn.....	Check the battery ground cable. Turn on the switch, replace the sealed beam units, replace the fuse, recharge the battery, or check the wiring and generator.*
Lights burn dim.....	Turn the switch to high. Recharge the battery, tighten the cable terminals, check the sealed beam units, clean the contacts.

Brakes

Do not hold.....	Adjust the brakes (page 67) or new lining needed.*
Drag or uneven.....	Adjust the brakes; see page 67.
Grease on lining.....	Replace the lining.*
Return spring broken.....	Replace.
Do not release.....	Release the brake lock. Be sure the left brake cross shaft is free to turn.

*See your International Harvester dealer.

MAINTENANCE

Possible Cause

Possible Remedy

Transmission, Belt Pulley and Power Take-Off

Hard to shift gears.....	Use lubricant of the correct viscosity; see page 35
Shifter fork or lever defective.....	Replace.*
Engine clutch drags.....	See "Lack of Power."
Gears clashing.....	Stop the tractor and disengage the clutch before shifting the gears.
Gears slipping out of mesh.....	*
Noisy.....	Check the oil level; use lubricant of the proper viscosity.*
Damaged parts.....	*

Rear Wheels

Do not turn.....	Release the brake lock. Transmission, differential or clutch faulty. See the transmission section above.*
------------------	---

Front Wheels

Too tight or too loose.....	Check the lubricant in the bearings, check the bearing adjustment; see page 35.
Lubricant leakage.....	Check the oil seal.*

Steering

Faulty.....	Check the steering worm and gear; check the front axle adjustment; see pages 70 to 73. Check the lubricant in the front wheel. Check the tire inflation.*
Defective front axle.....	Inspect the linkage, check and replace faulty parts.*
Tractor turns to one side.....	Check and adjust the brakes evenly; see page 67. Check the pneumatic tire air pressures. Check the front axle adjustment; see pages 72 and 73.

Pneumatic Tires

Excessive or uneven wear.....	Check for toe-in; see page 73. Check the air pressure and load on the tires; see page 74.
Slippage, rear tire.....	Add more weight, and check for high pressure; see page 74. If the tread is badly worn, the tires may slip more readily. Replace with new tires or use lug-type chains

Farmall Touch-Control System and Hydraulic Remote Control System

See the detailed instructions on pages 76 to 78.*

Fast-Hitch System

See the detailed instructions on pages 23 to 29.

*See your International Harvester dealer

MAINTENANCE

Storing and Housing Your Tractor

When your tractor is not to be used for some time, it should be stored in a dry and protected place. Leaving your tractor outdoors, exposed to the elements, will result in materially shortening its life.

Follow the procedure outlined below when your tractor is placed in storage, and repeat the lubrication precautions every six months thereafter. We also recommend that caution be practiced in starting an engine that has been in storage.

1. Wash or clean and completely lubricate the tractor. See the "Lubrication Guide."
2. Drain and flush the cooling system.
3. Tractors with magneto: Oil the magneto impulse coupling liberally with very light oil, such as cream separator or sewing machine oil.
4. After the engine has cooled off, remove the spark plugs and pour one tablespoonful of SAE-50 lubricating oil of good quality into each cylinder. Crank the engine two or three times to distribute the oil over the cylinder walls. Then replace the spark plugs.
5. Remove the valve housing cover and flush the valves, rocker arms and push rods with SAE-50 oil. If any evidence of rust is found, remove it before

lubricating.) Use a paint brush to coat the inside of the valve housing cover with SAE-50 lubricating oil. Replace the valve housing cover.

6. Plug up the end of the breather pipe and exhaust pipe.

7. Remove the oil filter element. (If any evidence of rust is found on the retaining bolt, clean it thoroughly.) Replace the old filter element with a new one and flush out any sludge from the filter base as instructed on page 34.

8. Drain the fuel from the fuel tank and carburetor, and clean out the fuel strainer glass bowl.

Caution! Gum will eventually form in the fuel tanks, lines and carburetor if the unit is not used. Gum in carburetor jets and passages affects engine starting. Gum can be dissolved with acetone or a 50-50 mixture of alcohol and benzol.

9. Remove the battery and place it on a rack or bench in a cool, dry place above freezing ($+32^{\circ}$ F.). Check the battery at least once a month for water level and specific gravity. See pages 64 and 65.

10. Block the clutch pedal with a wood block so that the clutch is disengaged. This will prevent the clutch facing from sticking to the flywheel or clutch pressure plate.

Starting Engines That Have Been in Storage

1. Remove the spark plugs and pour a mixture of one-half gasoline and one-half light lubricating oil into each cylinder; one ounce (two tablespoonfuls) per cylinder is enough.
2. Remove the valve housing cover and flush the base and valve operating mechanism with the same mixture.
3. Crank the engine rapidly until excess oil has been blown out of the spark plug holes. This operation will loosen any tight piston rings and wash old, gummy oil from valves and pistons.
4. Tractors with magneto: Flush out the impulse coupling with kerosene, and lubricate as specified.
5. Drain the crankcase and flush out with kerosene or flushing oil and fill with specified lubricating oil. See the "Lubrication Guide."
6. Be sure the lubricating oil filter has a new element before starting the engine.
7. Remove the crankcase breather pipe plug and exhaust pipe plug.
8. Install the spark plugs after cleaning and adjusting the gaps.

9. Fill the water cooling system.

10. Fill the fuel tanks.

11. Install a fully charged battery and be sure the proper connections are made. See the wiring diagram on page 62.

12. Clean the air cleaner and refill the oil cup.

13. Start the engine and let it run slowly; observe if any valves are sticking. If so, pour a small quantity of kerosene on the valve stem until loose.

14. Assemble the valve housing cover.

15. After the engine has been run long enough to clean the excess oil out of the cylinders, the spark plugs should be removed and checked for oil fouling. If fouled, clean and reinstall them in the engine.

16. Remove the block from the clutch pedal.

Caution! Do not accelerate the engine rapidly, or operate it at high speed immediately after starting. Also keep the doors wide open or move the machine outside the storage room immediately to avoid danger from exhaust gas.

SPECIAL EQUIPMENT

The tractor is used for so many different types of work and is called on to operate under so many different conditions that a considerable variety of special equipment is necessary to adapt it to the varied requirements of the user.

The tractor, as regularly supplied, is equipped to perform straight drawbar work. Beyond that the special equipment requirements are so diverse that it is impractical to include any such equipment regularly on the tractor. In many cases you would be paying for equipment you do not need or want.

These special attachments can be installed on the tractor at any time. Once installed, the special

attachments become a permanent part of your tractor.

Below is an index of the special equipment available. The instructions for operating and maintaining these attachments have been incorporated into the instructions for operating and maintaining the tractor. Supplemental information will be found in the following pages. You are urged to read and study this information in order to assure satisfactory service.

Special equipment must not be ordered from this manual. To order attachments, consult your International Harvester dealer, giving the tractor and engine serial numbers.

Types of Equipment	Attachment Number	Page No.
Adjustable Wide Front Axle (50 to 83 $\frac{1}{4}$ Inches).....	352 501 R93	85
Adjustable Wide Front Axle (56 to 89 $\frac{1}{4}$ Inches).....	354 817 R91	85
Air Pipe Extension.....	351 800 R91	86
Belt Pulley and Power Take-Off.....	351 315 R91	91
Combination Rear Light and Tail Light.....	353 914 R91	90
De Luxe Upholstered Seat.....	357 820 R91	89
Detachable Seat Pad.....	359 555 R91	89
Detachable Seat Pad (De Luxe).....	351 440 R92	89
Engine Hour Meter.....	356 735 R91	88
Exhaust Muffler.....	48 831 DB	85
Exhaust Valve Rotators.....	356 840 R91	86
Fast-Hitch Hydraulic Extension Attachment.....	365 250 R91	88
Fenders, Rear Wheel.....	351 255 R91	90
Front Wheel Rim (for 6.50-16 Tires).....	354 785 R91	92
Front Wheel Weight, First.....	48 600 D	92
Front Wheel Weight, Second.....	48 602 D	92
Pneumatic Tire Pump (Enginar).....	39 604 DA	90
Pneumatic Tire Pump (Schrader).....	39 622 D	90
Pneumatic Tire Pump Kit (Schrader).....	350 347 R91	90
Power Take-Off.....	354 655 R91	91
Pre-Cleaner (Collector Type).....	352 613 R91	86
Pre-Cleaner (Detachable-Sleeve Type).....	359 318 R91	86
Pre-Screener.....	353 410 R91	86
Radiator Shutter.....	355 770 R91	85
Rear Wheel Weight (First Set).....	61 719 D	93
Rear Wheel Weight (Second Set).....	49 330 D	93
Rear Wheel Weight (Third Set).....	49 351 D	93
Remote Control Cylinder Package.....	356 777 R91	87, 88
Remote Control Tractor Attachment.....	356 824 R91	87, 88
Seat Spring Attachment (Heavy Operator).....	354 672 R91	89
Seat Spring Attachment (Light Operator).....	354 673 R91	89
Single Front Wheel (for 7.50-16 Tire).....	58 254 D	92
Single Front Wheel (for 6.00-12 Tire).....	58 282 D	92
Spark Arrester.....	55 348 D	81
Tilt-Back Seat Bracket.....	356 890 R91	89
5,000-Foot Altitude Piston (Gasoline or Distillate).....	356 615 R91	85
5,000-Foot Altitude Piston (Kerosene).....	356 907 R91	85
8,000-Foot Altitude Piston (Gasoline or Distillate).....	356 617 R91	85
8,000-Foot Altitude Piston (Kerosene).....	356 909 R91	85
88-Inch Tread Rear Axle.....	351 498 R92	93
100-Inch Tread Rear Axle.....	351 495 R94	93

Adjustable Wide Front Axle

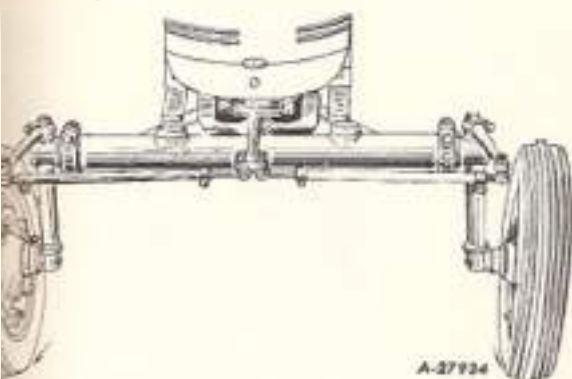

Illust. 45

Adjustable Wide Front Axle.

With an Adjustable Wide Front Axle, the front wheels can be set in various tread positions to fit a row of crops ranging from narrow rows of potatoes to wide rows such as cotton and corn. For further information see page 72.

Radiator Shutter

A radiator shutter is helpful for starting and warming in cold weather. In addition, a more even operating temperature can be maintained as the radiator shutter can be opened wide, closed tight (for starting), or set in any intermediate position.

Exhaust Muffler

The exhaust muffler can be supplied for owners who desire quieter operation of their tractors. It reduces the sound of the exhaust to a quiet purr.

The muffler attaches easily to the exhaust pipe. It may be attached to the spark arrester attachment in the same manner as it is attached to the exhaust

Spark Arrester

The spark arrester smotheres and extinguishes sparks that may be thrown off in the exhaust. It reduces the fire hazard when operating the tractor in inflammable material. The arrester attaches easily to the exhaust pipe. The muffler is attached

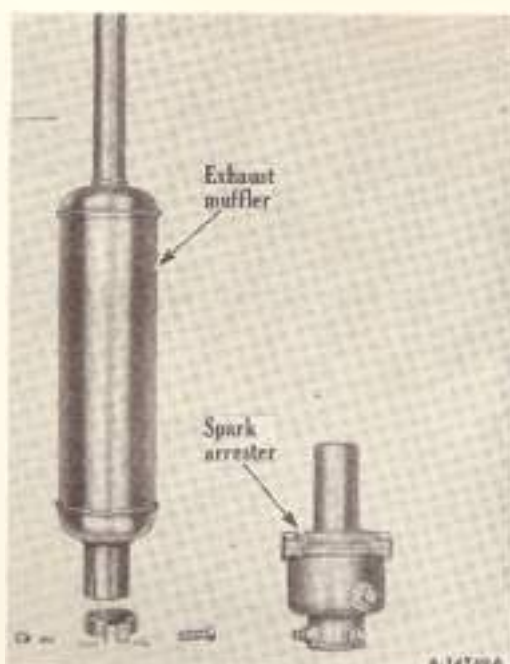

Illust. 55A

Exhaust muffler and spark arrester.

to the spark arrester in the same manner as it is attached to the exhaust pipe.

High Altitude Pistons

High altitude pistons for use at elevations of 5,000 and 8,000 feet are available on special order.

5,000-Foot Altitude Pistons

(Gasoline Operation)
(Distillate Operation)
(Kerosene Operation)

8,000-Foot Altitude Pistons

(Gasoline Operation)
(Distillate Operation)
(Kerosene Operation)

Note: These 5,000 and 8,000-foot attachments consist of a complete set of cylinder sleeves and pistons.

For installation, see your International Harvester dealer.

Air Pipe Extension

The air intake pipe regularly supplied is located high enough above the ground for most operating conditions. However, when heavy dust clouds continually envelop the breather pipe, it is best to add an air pipe extension. It raises the air screen above the dust, providing a fresher and cleaner supply of air for the engine which means longer tractor life and better performance.

Pre-Cleaner



Illust. 86

Pre-Cleaner (reflector type).

The Pre-Cleaner is recommended as added protection when working under excessively dusty conditions.



Illust. 86A

Pre-Cleaner (detachable-blade type).

Pre-Screener

This attachment replaces the regular air intake cap on the air cleaner and provides a means of overcoming or lessening plugging of the air cleaner caused by lint, cornstalk leaves, bean fuzz, etc.



Illust. 86B

Pre-Screener.

Remove the screen whenever necessary and clean thoroughly with a brush.

Exhaust Valve Rotators

Exhaust valve rotators will add many full-power hours to the engine life of your tractor. Rotators give valves a positive-turning motion that reduces burning by keeping the seats and stems clean, thereby assuring proper seating and preventing overheating.

The installation of these rotators will increase the life of the valves, and reduce maintenance costs. The rotators will help assure top performance of your tractor at all times.

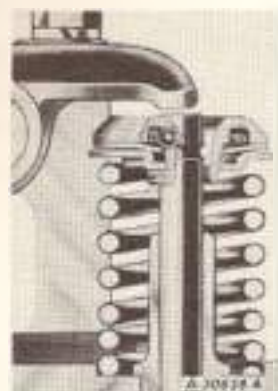

Illust. 86C

Cutaway view of the exhaust valve rotator.

SPECIAL EQUIPMENT

Hydraulic Remote Control System



Illustration 87

A mere finger touch of the hand lever straightens a disk harrow before crossing a grazed waterway.

Hydraulic pressure for the Remote Control system provided by the regular Farmall Touch-Control pump. Farmall Remote Control can be obtained ready installed on new tractors or can be installed on your present Farmall Super C. With Remote Control, you can make implement adjustments while on the go. Plows and other implements are lifted quickly and surely for fast turns or narrow headlands. Remote Control, with its powerful two-way action, not only raises implements, but also lowers them with controlled power. Because of this two-way action, you can maintain the operating position of an implement at any point between the fully raised and fully lowered positions. To harden soils, positive pressure on the piston applies down pressure so that an implement will work at the full depth selected. You can decrease as well as increase disk harrow angle on the go or you can work at the full angle selected by positioning the stop limit collar. You get more accurate, more positive control with two-way power.

The eight-inch stroke cylinder used in connection with Hydraulic Remote Control can be used on a variety of trailing-type implements. It may be used on any type or make of implement having mounting dimensions conforming to ASAE-SAE standards for cylinders of this size.

Thus, you can economically enjoy the benefits of Hydraulic Remote Control all season long—with trailing-type implements such as moldboard, disk or harrow plows, disk harrow, two-row lister, mower, field cultivator, and others.

You also can convert many of your present trailing-type implements to Remote Control operation. Easily-installed mounting kits are available for this purpose. Your IH dealer can give full information about McCormick implements.

The Remote Control cylinder is quickly transferred from job to job. It weighs only 26 pounds. When the load is removed from the cylinder, finger pressure is sufficient to release the pins holding the cylinder in the mountings. The mountings are equipped with pins to lock the implement in the raised position when the cylinder is removed.

The Remote Control attachment is easily installed on your Farmall Super C by merely removing the present manifold and installing the Remote Control manifold and valve.

The control lever, hoses and break-away coupling are also easily connected to the tractor by means of small bolts and clips.

Continued on next page.



Illust. 88

The lightweight, tubular steel cylinder (9 $\frac{1}{2}$ -inch diameter) is quickly installed on any implement having mounting dimensions conforming to ASAE-SAE standards.

The Hydraulic Remote Control Tractor Attachment (356 824 R91) consists of new manifold tubes from pump to cylinder block, a control valve with hand lever and connecting linkage, hose lines, break-away coupling front section and attaching parts.

The Hydraulic Remote Control Cylinder Package (356 777 R91) used with this attachment consists of a 2 $\frac{1}{2}$ x 8-inch hydraulic (push type) cylinder with hydraulic stop, two 105-inch hoses and a break-away coupling rear half. They are shipped without fluid.

Note: The Cylinder Package is not included with the Tractor Attachment and must be ordered separately if you do not already have it.

Fast-Hitch Hydraulic Extension Attachment

A Hydraulic Extension Attachment is available for the Farmall Super C with Farmall Fast Hitch.

This attachment consists principally of six hoses, two self-sealing couplings, hydraulic break-away coupling and bracket, six reducing bushings, and a cylinder replacement link.

This attachment permits you to use the rear-mounted, double-acting cylinder of Farmall Fast-Hitch to control trailing implements.

You can interchange the cylinder between Fast-Hitch and trailing implements quickly. No tools are needed; no oil is lost.

The cylinder is easily installed on any implement having cylinder mounting brackets that conform to



Illust. 88A

Fast-Hitch Hydraulic Extension Attachment.

standardized dimensions. An adjustable collar on the piston rod can be set to precisely regulate implement working positions.

Engine Hour Meter

This attachment includes an electrically operated hour meter for tractors equipped with starting and lighting.

The hour meter indicates the actual hours of engine operation, enabling the operator to determine without guesswork when lubrication, change of oil or periodic inspections are necessary. It also provides a means of computing cost of specific jobs and of recording fuel and oil consumption.



Illust. 88B

Engine hour meter.

SPECIAL EQUIPMENT

Detachable Seat Pads

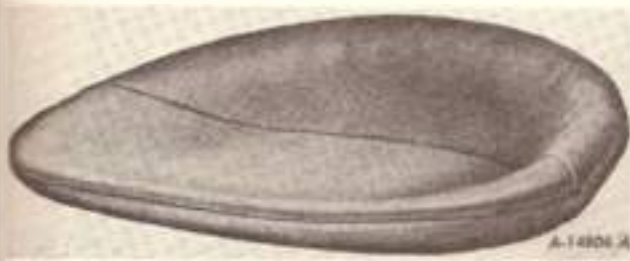

Illustr. 89
Detachable seat pad.

Two types of detachable seat pads are available to re-cover the regular seat or the de luxe upholstered seat. One seat pad is filled with jute felt padding, while the de luxe seat pad contains a foam rubber filler. Both pads have Silver Shade "Koro-seal" upholstery. The seat pads are quickly and easily fastened to the seat with drawstrings after the old upholstery has been removed.

De Luxe Upholstered Seat

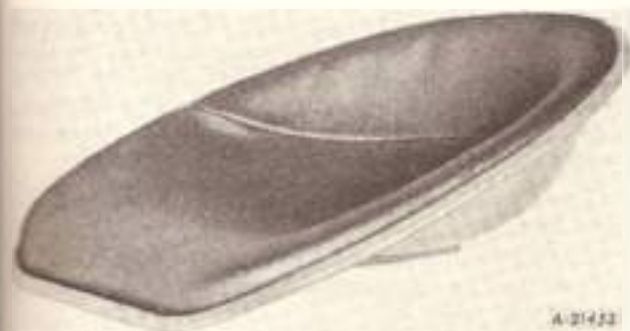

Illustr. 89A
Upholstered seat.

The de luxe upholstered seat is used to replace the regular seat when maximum riding comfort is desired. It consists of foam rubber padding covered with Silver Shade "Koro-seal" upholstery which has excellent water-repellent and wear-resisting qualities.

Since the Silver Shade finish has a tendency to reflect rather than absorb the sun's rays, the seat will remain cooler, thereby adding to the operator's comfort for hot weather operation.

Seat Springs

These attachments, consisting of a special conical spring which is interchangeable with the standard spring on a hydraulic-type seat, will accommodate a mediumweight or a heavyweight operator, depending on which spring is ordered.

The following chart shows the weights accommodated when the springs are compressed to a normal height of five inches and comparative data of the regular production spring. The springs can be identified by the number of notches in the top coil as shown in the table below:

Application	Weight of Operator	Number of Identifying Notches
Heavyweight operator.....	220 lb.	1
Mediumweight operator.....	180 lb.	4
Regular spring.....	140 lb.	3

Tilt-Back Seat Bracket

When equipped with the tilt-back seat bracket, the seat pan on the hydraulic seat support can be tipped up (left, *Illustr. 89B*) to provide ample room for the operator to stand. The seat can be set in a semi-vertical position, giving the operator a support against which he can brace his legs while standing. Also, the seat can be tilted all the way back (right, *Illustr. 89B*) to keep out rain and snow. When the seat is down, a latch keeps it from tilting if the operator grasps it while getting on or off the tractor.



Illustr. 89B
Tilt-back seat bracket.

SPECIAL EQUIPMENT

Combination Rear Light and Tail Light



Illust. 90

Combination rear light and tail light.

This attachment is interchangeable with the regular rear light and consists of a light with both a white and a red lamp for field and highway use respectively.

It is controlled by a selective switch located on top of the light.

Rear Wheel Fenders



Illust. 90A

Fenders assembled on the tractor.

Pneumatic Tire Pumps



Illust. 90B

Engine air tire pump with 16-foot hose and air gauge.

Engine or Schrader

These tire pumps are useful where air service is not easily available. They may be used for inflating tractor, truck, or automobile tires.

Note: These tire pumps may be used with any carbureted-type engine, but they cannot be used on diesel engines. The tire pumps also are available for various spark plug thread sizes. Specify the size of spark plug thread when ordering.

Schrader spark plug tire pump kit: This kit consists of items which are necessary for proper care of the tire valve and maintenance of proper air pressure. With this kit you can maintain tire pressure on all tractors, trucks and passenger cars by changing adapters on the tire pump to suit the spark plug thread size.

The following items are packed in a serviceable metal box:

- One tire pump with 16 feet of hose and an air gauge for registering pressure up to 100 pounds.
- Five adapters for spark plug thread sizes of 10 mm., 14 mm., 18 mm., $\frac{7}{8}$ -18 and $\frac{1}{2}$ -inch.
- Five valve cores and five valve caps which fit all standard tire valves (packed in small metal boxes).
- One valve repair tool and one valve fishing tool.
- One air-water tire valve and one air-water adapter.
- One tire pressure gauge for air-water tractor tires.

SPECIAL EQUIPMENT

Belt Pulley and Power Take-Off

The belt pulley and power take-off may be obtained as a unit or the power take-off may be obtained separately.

The instructions for operating the Belt Pulley and Power Take-Off attachments are on pages 30 to 32. For lubrication see page 41.

The power take-off extends the power of the engine to the rear of the tractor for operating power-driven implements. The power take-off shaft projects through the rear of the differential housing, and is driven by the transmission drive shaft. The power take-off shifter lever engages and disengages the power take-off shaft from the transmission drive shaft; the engine clutch must always be disengaged before moving this shifter lever. The power take-off has a speed of 539 r.p.m. (under full load). The low idle speed is 139 r.p.m. and the fast idle speed is 393 r.p.m. (no load).

The belt pulley increases Farmall 200 utility by making the power of the tractor engine available for the operation of belt-driven machines such as corn shellers, feed grinders and hammer mills.

The regular pulley has an 8½-inch diameter with a six-inch face. The shaft speed is 1,363 r.p.m. (under full load), which gives a belt speed of 3,033 feet per minute. There is another pulley available that has a 7½-inch diameter with a 6½-inch face. This pulley, with a shaft speed of 1,363 r.p.m. (under full load), gives a belt speed of 2,760 feet per minute. The low idle pulley speed is 351 r.p.m. and the fast idle speed is 1,499 r.p.m. (no load).

When the belt pulley attachment is not in use, the pulley can be removed; the exposed shaft should then be covered with a spacer and pulley shaft guard.

When the power take-off shaft is not in use, cover it with the power take-off shaft guard.

The Farm Equipment Institute Advisory Committee of Engineers, in cooperation with the Ameri-

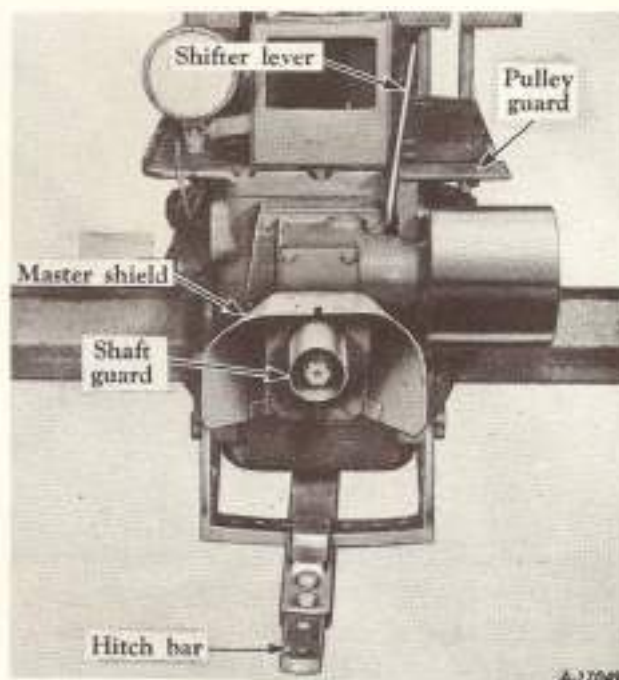

Illustr. 92

Belt pulley, power take-off, master shield, etc.

can Society of Agricultural Engineers, developed standard specifications for the power take-off, master shield, and drawbar hitch point to assure a safe and properly operating hitch. These standard specifications are known as the A.S.A.E. Standard Power Take-off.

This standard has been adopted by practically all farm tractor and implement manufacturers. With tractors and pull-behind power-driven machines built to these standards or converted to them, it is possible to use any make and kind of power-driven machine with any make and model of tractor.

The power take-off for your tractor conforms to standard dimensions and will operate any implement built to these standards. Implements that do not conform to these standards may be adapted to your tractor by means of conversion packages. To secure conversion packages, consult your local dealer handling your make of equipment.

SPECIAL EQUIPMENT

Single Front Wheel



Rim. 92

Single front wheel.

Single front wheel attachments are used for cultivating crops grown in narrow row spacings.

Two attachments are available; one is for 6.00-12 tires and the other for 7.50-10 tires. These attachments include a new front wheel fork, front axle and front wheel complete, less tire and tube.

Front Wheel Rims (4.50E—16DC) (For 6.50—16 Pneumatic Tires)



Illust. 92A

Adjustable Wide Front Axle, adjustable front wheels and 6.50-16 pneumatic tires.

These rims are available for tractors equipped with an Adjustable Front Axle and adjustable front wheels. The attachment consists of wider rims for mounting larger tires, thereby providing better flotation, particularly in light, sandy soil.

Front Wheel Weights



Illust. 92B

First front wheel weight assembled on the tractor.

The front wheel weights weigh approximately 42½ pounds each, and either one or two can be attached to each front wheel.

To increase steerability, front wheel weights are recommended for use as a front-end counterbalance whenever heavy loads are superimposed on the drawbar, or when heavy equipment is to be mounted on the rear end of the tractor. The front wheel weight attachment includes a set of two weights and the necessary attaching bolts, nuts and lock washers.

If additional weight is desired a second set of weights is available for attaching to the first weights.



Illust. 92C

First and second front wheel weights assembled on the tractor.

88-Inch Tread Rear Axle 100-Inch Tread Rear Axle

The 88-Inch Tread Rear Axle Attachment consists of a set of two longer rear axles which when applied on the tractor increases the tread of the rear wheels from a maximum of 80 inches (regular) to a maximum of 88 inches.

The 100-Inch Tread Rear Axle Attachment consists of a set of two longer rear axles and a set of rear axle carriers which when applied on the tractor increases the tread of the rear wheels from a maximum of 80 inches (regular) to a maximum of 100 inches.

Increasing the Rear Tire Tread

Raise the rear of the tractor so that one of the rear wheels is off the ground.

Caution! Be sure the tractor is rigidly supported. Lock both brakes and block the front wheels and the other rear wheel.

Place the wheel in the desired position on the rear axle and tighten the clamp evenly and securely. Then lower the tractor, raise the opposite rear wheel, and proceed as described above.

Rear Wheel Weights

Rear wheel weights, weighing approximately 145 pounds each, can be attached to each drive wheel to reduce slippage and increase drawbar pull. Either one, two or three weights can be attached to each drive wheel. The increase in drawbar pull, with the proportionate reduction of slippage, varies with the type of soil.

The rear wheel weight attachment includes a set of two weights with the necessary attaching bolts,



Illustr. 92

First rear wheel weight assembled on the tractor.

nuts and lock washers. If additional weight is desired, a second or third set of weights is available for attaching to the first weights.



Illustr. 93A

First and second rear wheel weights assembled on the tractor.

SPECIFICATIONS

Approximate Capacities (Approximate U.S. Measure)

Cooling system	15 qt.
Fuel tank	11 gal.
Gasoline starting tank (with distillate or kerosene engine)	$\frac{1}{8}$ gal.
Crankcase pan	5 qt.
Transmission case (when not equipped with belt pulley and power take-off)	4 $\frac{1}{4}$ gal.
Transmission case (when equipped with belt pulley and power take-off)	5 gal.
Steering gear housing	1 $\frac{1}{4}$ pt.
Air cleaner oil cup (Donaldson or United)	$\frac{1}{4}$ pt.
Touch-Control system (a completely dry unit when first installed) without Remote Control	8 $\frac{1}{4}$ pt.
Refill	6 $\frac{3}{4}$ pt.

Engine

Cylinders	4	
Bore	3 $\frac{1}{8}$ in.	
Stroke	4 in.	
Engine speeds	Minimum (engine speed control lever)	Approx. 425 r.p.m.
	Maximum idle speed (no load)	Approx. 1,815 r.p.m.
	Governed, maximum (full load)	1,650 r.p.m.
Battery ignition unit (clockwise rotation, 30° advance)	IH	
Magneto (when so equipped) (fixed spark, clockwise rotation)	IH Type H-4	
Spark plug gap	.023 in.	
Valve clearance (engine hot)	.014 in.	
Carburetor	$\frac{1}{8}$ in., updraft	

Clutch

Single-plate, dry-disc, spring-loaded	9 in.
---------------------------------------	-------

Fuse and Headlight or Rear Light

Fuse (cartridge type)	SFE-20
Headlight or rear light sealed unit	6.8 volt

Belt Pulley and Power Take-Off

Pulley speeds	Low idle (no load)	Approx. 351 r.p.m.
	Fast idle (no load)	Approx. 1,499 r.p.m.
	Maximum (full load)	1,363 r.p.m.
Belt speed (with 8 $\frac{1}{8}$ -inch pulley) (at full load engine speed)	3,133 ft. per min.	
Pulley diameter	8 $\frac{1}{8}$ in.	
Pulley face	6 in.	
Power take-off shaft speeds (clockwise rotation)	Maximum (full load)	539 r.p.m.
	Low idle (no load)	Approx. 139 r.p.m.
Power take-off shaft speeds (clockwise rotation)	Fast idle (no load)	Approx. 593 r.p.m.

SPECIFICATIONS

Foot Brakes

Mechanical-disc type on bull pinion and differential shafts, operated either individually or interlocked.

Transmission (four-speed)

Speeds based on 10-36 pneumatic tires.

Speed (miles per hour):	1st.....	2 1/2
	2nd.....	3 1/2
	3rd.....	5 1/2
	4th.....	10 3/4
	Reverse.....	3 1/2

Wheels and Tread

Front wheels, pneumatic tire size.....	†5.00—15
Rear wheels, pneumatic tire size.....	†10—36
Tread, front (with adjustable-tread wheels).....	6 3/4, 9 1/2, and 12 3/4 in.
Tread, rear (adjustable) (wheels turned in).....	48 to 71 in.
(wheels turned out).....	57 to 80 in.
Wheelbase.....	82 1/4 in.

† Other pneumatic tire sizes available.

General Dimensions

Length overall.....	123 in.
Width overall: Minimum (to outside edge of rear axles).....	80 1/2 in.
Maximum (over rear tires in widest tread).....	90 3/4 in.
Height overall (to top of steering wheel).....	74 3/4 in.
Height to top of exhaust muffler.....	85 3/8 in.
Ground clearance for crops under rear axle.....	23 3/8 in.
*Clearance under drawbar in upper adjustment position.....	15 in.
*Clearance under rear frame (drawbar removed).....	17 1/4 in.
*Drawbar height above ground (adjustable) (tongue hitch bar in inner position).....	14 3/8, 17 1/2, 20 1/4 and 22 5/8 in.
*Drawbar lateral swing (tongue hitch bar in inner position).....	16 1/4 in.
○ Clearance under drawbar in upper adjustment position (minimum).....	9 3/4 in.
○ Swinging drawbar height above ground.....	1 3/8 to 23 in.
With replacement link.....	12, 15 1/2, 19 1/4 in.
○ Swinging drawbar lateral swing (total).....	28 in.
○ Regular drawbar height above ground.....	5 1/4 to 22 1/4 in.
With replacement link.....	13 1/2, 16 1/2, 19 1/2 in.
○ Regular drawbar lateral adjustment (total).....	18 3/4 in.
○ A.S.A.E. standardized hitch (using drawbar extension plate)	
Height above ground (to top of extension plate with drawbar in lowest position using replacement link).....	14 in.
Hitch hole to end of power take-off shaft.....	13 7/8 in.
Minimum turning radius (wheels in minimum tread)	
Without brake applied.....	7 ft. 11 in.
With brake applied.....	7 ft. 6 in.

* Tractors without Fast-Hitch.

○ Tractors with Fast-Hitch and Drawbar Attachment.

Specifications are subject to change without notice.

<https://www.tractormanualpdf.info/>

INDEX

Description	Page No.	Description	Page No.
Adjustable front wheels	70, 71	Drain plug, transmission	41
Adjustable wide front axle	72, 73, 83	Drawbar	27, 29, 30
Air cleaning system	9, 38, 49	Drawbar (Fast-Hitch)	27, 28
Air pipe extension	86	Driving the tractor	16, 17
Ammeter	3	Engine hard to start	79
Antifreeze solutions	46	Engine hour meter	88
Axles, rear	93	Engine serial number	2
Battery	7, 64, 65	Engine specifications	94
Battery ignition unit	51 to 54	Engine speed control lever	5, 11, 14, 16
Battery testing	64, 65	Engine speeds	5
Before starting your new tractor	7	Exhaust muffler	85
Belt pulley	5, 32, 41, 91	Exhaust valve rotators	86
Bracket, tilt-back seat	89	Fan	40, 48
Brake pedal latch	4, 16	Fan belt	48, 49
Brake pedals	4, 16, 18	Farmall Touch-Control system	6, 18, 39, 41, 76
Brakes	4, 18, 67	Fast-Hitch system	21 to 29
Brakes, locking the	4, 18	Filter element	34, 39
Cables, electrical equipment	51, 62, 63	Front axle, adjustable type	72, 73, 83
Cables, spark plug	51	Front wheel rims	92
Carburetor	43 to 45	Front wheels	70, 71
Carburetor fuel line screen	43	Fuel filler cap	8
Chains, tire	76	Fuel screens	43
Choke rod	4, 11, 12	Fuel strainer	43
Cleaning the radiator	47	Fuel system	7, 10, 11, 13, 15, 43 to 45, 81
Clutch	4, 16, 38, 68, 69	Fuel tank	7, 8
Clutch pedal	4, 16, 68	Fuse	59
Cold weather precautions	43, 65	Gearshift lever	6, 11, 14, 16, 18, 82
Cooling system	7, 8, 45 to 49	Generator	39, 60
Coupling Fast-Hitch implements	22, 23	Generator belt	48, 60
Crankcase	9, 33, 38, 66, 80	Governor	5
Crankcase breather	33	Grease specifications	35, 36
Cranking motor	40, 61	Greasing the front wheels	35
Cylinder head gasket	66	Hand-cranking the engine	12, 14
Distributor cap, battery ignition	40, 52	Headlights	59
Distributor cap, magneto	40, 56	Heat indicator (cooling system)	6, 14
Drain pipe, radiator	47	Heat indicator (Touch-Control)	6, 19
Drain plug, engine crankcase	39	High altitude pistons	85
Drain plug, steering gear housing	41	Hitching (without Fast-Hitch)	29, 30
Drain plug, Touch-Control reservoir	41		

INDEX

Description	Page No.	Description	Page No.
Hour meter.....	88	Periodic inspections.....	42, 43
Hydraulic extension attachment.....	26, 88	Pistons (high altitude).....	85
Hydraulic Remote Control lever.....	6, 9, 21	Pneumatic tires.....	7, 74 to 76
Hydraulic Remote Control system.....	6, 9, 19, 76, 87	Pneumatic tire pumps.....	52, 74, 90
Ignition cables.....	7, 51	Points, ignition.....	51, 55
Ignition coil.....	55	Polarizing the generator.....	60
Ignition switch button.....	5, 11, 14	Power take-off.....	5, 30, 51, 91
Ignition trouble.....	81	Pre-Cleaner.....	50, 86
Inflation, tire.....	32, 74	Preparing your tractor for each day's work.....	8
Instrument panel.....	59	Pre-Screener.....	30, 86
Instruments and controls.....	4 to 6	Radiator.....	7, 13, 45 to 48
Introduction.....	2	Radiator, filling the.....	7, 13, 45, 47
Knocking engine.....	79	Radiator shutter.....	6, 10, 13, 15, 85
Lighting switch.....	5, 59	Raising and lowering implements.....	19, 21 to 29
Lubricating oil and grease specifications.....	35, 36	Raising the tractor wheel.....	28
Lubrication, engine and chassis.....	7, 33 to 41, 45, 83	Rear light and tail light.....	90
Lubrication, front wheel.....	35	Rear wheels.....	74
Lubrication guide.....	37 to 41	Remote Control cylinder.....	9, 20
Lubrication table.....	36	Remote Control system.....	6, 8, 19, 76, 87
Magneto.....	39, 54 to 57	Rubber hose connections (air cleaner).....	50
Magneto impulse coupling.....	59, 45, 55	Rust prevention.....	47, 48
Manifold heat control.....	6, 14, 15	Seat.....	78
Minor engine service operations.....	66	Seat bracket, tilt-back.....	89
Oil filter.....	33, 39, 83	Seat, de luxe upholstered.....	89
Oil pressure indicator.....	5, 12, 14, 33	Seat pads, detachable.....	89
Oil pump.....	33	Seat spring attachments.....	89
Operating a distillate engine.....	13 to 15	Sediment bowl (fuel strainer).....	43
Operating a gasoline engine.....	10 to 12	Serial numbers, engine and tractor.....	2
Operating a kerosene engine.....	15	Shipping oil.....	7
Operating the belt pulley.....	32	Shipping the tractor.....	75
Operating the Fast-Hitch system.....	21 to 29	Shut-off valve, fuel.....	13, 14, 15
Operating the power take-off.....	50, 31	Spark arrester.....	85
Operating the pneumatic tire pump.....	32	Spark coil.....	53
Operating the Remote Control system.....	19 to 21	Spark plug pumps.....	32, 74, 90
Operating the Touch-Control system.....	18, 19	Spark plugs and cables.....	51
Operating your tractor.....	10 to 18	Special equipment index.....	84
Overheated engine.....	80	Specifications, lubricant.....	35, 36
		Specifications, tractor.....	94, 95

INDEX

Description	Page No.	Description	Page No.
Speeds, engine.....	5	Tire pressure table.....	75
Starting a distillate engine.....	14, 15	Tire pumps, pneumatic.....	32, 74, 90
Starting a gasoline engine.....	11, 12	Tires, pneumatic.....	7, 74, 82
Starting a kerosene engine.....	15	Toe-in, front wheel.....	73
Starting and lighting equipment.....	58 to 63	Touch-Control system.....	{ 6, 18, 19, 39, 76
Starting a stored engine.....	83	Tractor serial number.....	2
Starting switch control rod.....	5, 11, 14	Transmission.....	41, 82
Starting the tractor.....	16	Trouble shooting chart.....	79 to 82
Steering mechanism.....	41, 82	Uncoupling Fast-Hitch implements.....	23
Steering the tractor.....	17	Valve clearance adjustment.....	66
Stopping a distillate engine.....	15	Valve rotators (exhaust).....	86
Stopping a gasoline engine.....	12	Valve stem mounting cones.....	76
Stopping a kerosene engine.....	15	Views of the tractor.....	3
Stopping the tractor.....	18	Wheels.....	{ 35, 70 to 74, 92
Storage battery.....	64, 65	Wheels, greasing the front.....	35
Storing and housing your tractor.....	83	Wheel weights.....	92, 93
Swinging drawbar.....	29, 30	Wheel weights, liquid.....	75, 76
Thermostat.....	48	Wiring diagram (battery ignition).....	62, 63
Tilt-back seat bracket.....	89	Wiring diagram (magneto).....	62, 63
Timing the distributor (battery ignition).....	53, 54		
Timing the magneto.....	57		
Tire chains.....	76		





Accidents can be prevented with your help

No accident-prevention program can be successful without the wholehearted co-operation of the person who is directly responsible for the operation of equipment.

To read accident reports from all over the country is to be convinced that a large number of accidents can be prevented only by the operator anticipating the result before the accident is caused and doing something about it. No power-driven equipment, whether it be transportation or processing, whether it be on the highway, in the harvest field or in the

industrial plant, can be safer than the man who is at the controls. If accidents are to be prevented—and they can be prevented—it will be done by the operators who accept a full measure of their responsibility.

It is true that the designer, the manufacturer, the safety engineer can help; and they will help, but their combined efforts can be wiped out by a single careless act of the operator.

It is said that "*the best kind of a safety device is a careful operator.*" We ask you to be that kind of an operator.

NATIONAL SAFETY COUNCIL



For Your Protection

Always Use Parts

The finest engineering skill and the most advanced manufacturing methods go into all International Harvester products. Each part is built to our own high manufacturing standards. These are important things to remember when wear and tear make new parts necessary.

IH parts retain and continue the original performance you get when you choose International Harvester quality products. When replacing parts, don't handicap your equipment. For your

protection, be sure to use IH SERVICE PARTS.

International Harvester dealers' bins are well stocked with IH parts and their well-equipped service departments are staffed by trained servicemen. Dealers are backed in every case by the full facilities of a nearby International Harvester District Office and Parts Depot.

When selecting new farm operating equipment, keep in mind the protective service facilities provided by the International Harvester dealer in your community.