

**CDM853**

**WHEEL LOADER**

*(Joystick Control)*

**OPERATION MANUAL**

## **PREFACE**

Thank you for purchasing LONKING's wheel loader!

This Manual briefly describes the safety, operational and maintenance requirements of CDM853 wheel loaders for the use and reference by operators, maintenance and technical management personnel.

Operation Manual is a guide for proper use and maintenance of this machine. Please carefully read and understand the contents of this Manual before operating this machine.

Please put this Manual in driver's cab for convenience of reference at any moment. If you lose this Manual, please contact our sales department for buying a new one.

Many failures arise as a result of operator's failure to carefully read this Manual and other human reasons. A high sense of safety and good maintenance enable the safe and efficient operation of this machine, thus bringing you more benefits. Therefore, please read and understand safety instructions before operating this machine and fully comply with them. Improper operation, lubrication, maintenance and repair of this machine are dangerous and may result in human casualties.

We will continue to increase the working efficiency of the machine by improving product design and endeavoring to improve the comprehensive product performances. The parameters and configurations of the machine in this Manual are subject to change without notice. The technical parameters contained herein shall not serve as the basis for any inspection or test.

In order to offer better services to you and improve product and service quality, you are expected to timely inform us of any problem identified during your use of LONKING products and this Manual, along with any corresponding improvement opinions.

This Manual is its first version .

Best wishes for your business!

LONKING Holdings Limited

July 2016

# CONTENTS

PREFACE.....	1
CONTENTS.....	2
CHAPTER I SAFETY PRECAUTIONS.....	7
1.1DESCRIPTION OF SAFETY SIGNS.....	7
1.2DESCRIPTION AND LOCATIONS OF SAFETY SIGNS.....	7
1.2.1 WARNING SIGN OF REVERSING.....	8
1.2.2 WARNING SIGN OF THE ANTI-FREEZE FLUID.....	8
1.2.3 WARNING SIGN OF MAINTENANCE AND TRANSPORTATION.....	8
1.2.4WARNING SIGN OF LIFT ARM.....	9
1.2.5 SAFETY WARNING SIGN OF HINGE.....	9
1.2.6 WARNING SIGN OF FAN.....	10
1.2.7 WARNING SIGN OF NO TRAMPLE.....	10
1.2.8 DISTRIBUTING DIAGRAM OF GREASE NIPPLE AND LUBRICATING POINTS.....	10
1.2.9 MACHINE NAMEPLATE.....	11
1.2.10 LIFTING AND BINDING SIGN.....	11
1.2.11 HYDRAULIC OIL SIGN.....	12
1.2.12 SCHEMATIC DIAGRAM OF USE OF TRIANGLE IRON.....	12
1.2.13 FUEL SIGN.....	12
1.2.14 WARNING SIGN FOR SCRAPING.....	13
1.2.15 ATTACHMENT NAMEPLATE.....	13
1.2.16SIGN OF FLUSHER CONTAINER.....	13
1.2.17 WARNING SIGN OF PREVENTING SINKING MOVEMENT.....	14
1.2.18 SAFETY EXIT SIGN.....	14
1.2.19 SCALDING WARNING SIGN AT HIGH TEMPERATURE PLACE	14
1.2.20 REMARKS FOR LONG TIME STANDSTILL.....	15
1.2.21 SIGN OF BATTERY CONNECTING WIRE.....	15
1.2.22 COMBINATION OF WARNING SIGNS.....	16
1.3UNAUTHORIZED MODIFICATION.....	17
1.4GENERAL SAFETY PRECAUTIONS.....	17
1.4.1SAFETY REGULATIONS.....	17
1.4.2PROTECTIVE DEVICES.....	18
1.4.3SAFETY PRECAUTION FOR INTERNAL CAB.....	18
1.4.4WORKING CLOTHES AND PERSONAL PROTECTIVE EQUIPMENTS.....	19
1.4.5GETTING ON AND OFF THE MACHINE.....	20
1.4.6FIRE PREVENTION OF OIL PRODUCTS.....	21
1.4.7PRECAUTIONS WHEN OPERATING AT HIGH TEMPERATURE.....	22
1.4.8PROTECTION OF ASBESTOS DUST HAZARD.....	22
1.4.9FACE MASK AND EARPLUG.....	23

1.4.10	FIRE EXTINGUISHER AND FIRST-AID KIT.....	23
1.4.11	PREVENTION OF ROLLING INJURY OR CUT OFF.....	23
1.4.12	ETHER (IF YOUR MACHINE IS EQUIPPED WITH ETHER COLD STARTING DEVICE).....	24
1.4.13	MAKE SURE A GOOD VENTILATION WHEN OPERATING IN AN ENCLOSED SPACE.....	24
1.4.14	PIPELINE, HARD PIPE AND FLEXIBLE PIPE.....	25
1.4.15	COOLANT.....	26
1.4.16	PROTECTION FROM FALLING OR FLYING OBJECTS.....	26
1.5	SAFETY PRECAUTION OF OPERATION.....	27
1.5.1	SITE SAFETY.....	27
1.5.2	CHECK BEFORE ENGINE START-UP.....	28
1.5.3	ENGINE START-UP.....	30
1.5.4	CHECK AFTER ENGINE STARTING UP AND BEFORE MACHINE OPERATION.....	31
1.5.5	PRECAUTIONS WHEN THE MACHINE BEGINS TO TRAVEL.....	32
1.5.6	PRECAUTIONS WHEN THE MACHINE IS TRAVELING.....	32
1.5.7	CHECK WHEN CHANGING DIRECTION.....	33
1.5.8	PROHIBITED OPERATION.....	34
1.5.9	PRECAUTIONS WHEN TRAVELING ON THE SLOPE.....	34
1.5.10	BEWARE OF HIGH VOLTAGE CABLES.....	36
1.6	PRECAUTION FOR OPERATION.....	37
1.6.1	METHODS OF USING A BRAKE.....	38
1.6.2	PRECAUTIONS WHEN OPERATING ON SNOWY DAYS.....	38
1.6.3	PRECAUTIONS FOR OPERATION IN COLD AREAS.....	38
1.6.4	DO NOT OPERATE THE MACHINE ON SOFT GROUND.....	39
1.6.5	PRECAUTIONS WHEN PARKING THE MACHINE.....	40
1.6.6	PRECAUTIONS WHEN LOADING THE MACHINE.....	40
1.6.7	PRECAUTIONS OF MACHINE TRANSPORTATION.....	41
1.6.8	PRECAUTIONS FOR DRAG.....	41
1.6.9	PRECAUTION FOR USE AND MAINTENANCE OF THE BATTERY.....	42
1.6.10	PRECATUTION FOR START-UP WITH BOOSTER CABLE.....	43
1.6.11	PRECAUTIONS FOR BATTERY CHARGE.....	44
1.7	MAINTENANCE PRECAUTIONS.....	44
1.7.1	FAULT NOTIFICATION.....	44
1.7.2	CLEANING BEFORE REPAIR AND MAINTENANCE.....	44
1.7.3	KEEP CLEANNESS OF WORKPLACE.....	45
1.7.4	DESIGNATION OF RESPONSIBLE PERSON.....	45
1.7.5	CHECKING WATER LEVEL OF RADIATOR.....	45
1.8	OPERATING BEFORE REPAIR AND MAINTENANCE.....	46
1.8.1	SUPPORT OF WORKING DEVICE.....	46
1.8.2	APPROPRIATE TOOLS.....	46
1.8.3	REGULAR REPLACEMENT OF CRITICAL SAFETY PARTS.....	47

1.8.4	ILLUMINATION.....	47
1.8.5	FIRE PREVENTION.....	47
1.8.6	PERSONS FOR REPAIR AND MAINTENANCE.....	48
1.8.7	ATTACHMENTS.....	48
1.8.8	MAINTENANCE UNDER MACHINE.....	49
1.8.9	MAINTENANCE WITH THE FRAME SUPPORTED UP.....	49
1.8.10	MAINTENANCE ON THE TOP OF THE MACHINE.....	49
1.8.11	MAINTENANCE WHEN ENGINE IS WORKING.....	50
1.8.12	NO LEAVING OF FOREIGN MATTER INSIDE MACHINE.....	51
1.8.13	PRECAUTIONS IN THE USE OF HAMMER.....	51
1.8.14	WELDING REPAIR.....	51
1.8.15	PRECAUTIONS FOR BATTERY MAINTENANCE.....	52
1.8.16	TREATMENT OF ABNORMAL STATUS.....	52
1.8.17	FILL OF FUEL OR LUBRICATING OIL.....	52
1.8.18	HANDLING OF HIGH-PRESSURE HOSE.....	53
1.8.19	PRECAUTIONS OF HIGH-PRESSURE OIL.....	53
1.8.20	PREVENTION MEASURES OF MAINTENANCE	
	IN HIGH TEMPERATURE OR HIGH PRESSURE.....	53
1.8.21	WASTE DISPOSAL.....	54
1.8.22	PRECAUTIONS OF TIRE MAINTENANCE.....	54
1.8.23	PRECAUTIONS OF TIRE STORAGE.....	56
1.9	CATALOG AND REPLACEMENT CYCLE OF CRITICAL	
	SAFETY PARTS.....	56
CHAPTER II	OPERATION AND CONTROL.....	58
2.1	MAIN PERFORMANCE PARAMETERS AND SPECIFICATION.....	59
2.2	OUTLINE DRAWING OF WHEEL LOADER.....	62
2.3	PURPOSE.....	64
CHAPTER III	OPERATION INSTRUCTIONS.....	65
3.1	STEERING WHEEL.....	65
3.2	NEGATIVE-POLE SWITCH OF BATTERY.....	65
3.3	STARTER SWITCH.....	66
3.4	SERVICE BRAKE PEDAL.....	67
3.5	ACCELERATOR PEDAL AND INSTRUMENT PANEL	
	ADJUSTING MECHANISM.....	68
3.6	ELECTRICALLY CONTROLLED SPEED-SHIFT	
	HANDLE 68	
3.7	PILOT JOYSTICK.....	69
3.8	LAMPS AND THEIR SWITCHES.....	70
3.9	INSTRUMENT ASSEMBLY AND HORN SWITCH.....	72
	3.9.1 INSTRUMENT ASSEMBLY.....	73
	3.9.2 HORN SWITCH.....	75
3.10	SWITCH OF AIR CONDITIONING SYSTEM.....	75
	3.10.1 WARM WATER VALVE.....	76
3.11	SEAT ADJUSTMENT.....	76

3.12 SAFETY BELT.....	78
3.13 CAB DOOR LOCK.....	78
3.14 USE OF LOCATING LOCK.....	78
3.15 ADJUSTMENT TO REAR-VIEW MIRROR.....	79
3.16 TURNING LAMPS AND FULL-BEAM/LOW-BEAM HEADLIGHTS.....	79
3.17 CHARGING DOCK.....	80
3.18 SUNSHADE.....	80
3.19 PLAYER.....	81
CHAPTER IV OPERATION.....	83
4.1 NOTICES ON OPERATION OF NW LOADER.....	83
4.2 RUNNING-IN OF NEW LOADER.....	84
4.2.1 REQUIREMENTS ON RUNNING-IN OF NEW LOADER.....	84
4.2.2 OPERATIONS TO BE CARRIED OUT AFTER EIGHT HOURS OF RUNNING-IN.....	84
4.2.3 OPERATIONS TO BE CARRIED OUT AFTER EXPIRATION OF RUNNING-PERIODS.....	85
4.3 OPERATION OF LOADER.....	85
4.3.1 INSPECTION BEFORE STARTUP OF ENGINE.....	85
4.3.2 STARTUP OF ENGINE.....	86
4.3.3 TRAVELLING OF LOADER.....	87
4.3.4 PARKING OF LOADER.....	90
4.4 WORKING OF LOADER.....	92
4.4.1 PREPARATION BEFORE WORKING.....	92
4.4.2 GENERAL TECHNIQUES.....	92
4.4.3 WORK METHOD.....	95
4.5 TRANSPORTATION OF LOADER.....	96
4.5.1 HOISTING OF LOADER.....	97
4.6 OPERATION IN COLD WEATHER.....	100
4.6.1 PRECAUTIONS FOR OPERATION AT LOW TEMPERATURE..	100
4.6.2 OPERATIONS TO BE CARRIED OUT AFTER COMPLETION OF WORKS IN EACH DAY.....	101
4.6.3 AFTER COLD WEATHER HAS ENDED.....	101
4.7 OPERATION UNDER SPECIAL CONDITIONS.....	102
4.7.1 OPERATION UNDER EXTREMELY COLD CONDITIONS.....	102
4.7.2 OPERATION UNDER EXTREMELY HOT WEATHER.....	103
4.7.3 OPERATION IN DUSTY OR SANDY AREA.....	104
4.7.4 OPERATION IN RAINY AND HUMID ENVIRONMENT.....	104
4.7.5 OPERATION IN SALT WATER.....	104
4.7.6 OPERATION AT HIGH ALTITUDE.....	105
CHAPTER V MAINTENANCE AND REPAIR.....	106
5.1 PREPARATION BEFORE MAINTENANCE.....	106
5.2 REGULAR MAINTENANCE.....	106
5.3 LUBRICATION CHART.....	115
5.4 THE CHINESE AND FOREIGN OIL TYPE LIST FOR WHEEL	

<u>LOADER</u> .....	116
5.5 OIL INFORMATION.....	118
5.6 UNIVERSAL TORQUE TABLE.....	119
5.7 MAINTENANCE OF THE ENGINE COOLANT.....	119
5.7.1 COOLANT COMPOSITION.....	120
5.7.2 ADDING COOLANT.....	121
5.7.3 INSPECT COOLANT LEVEL REGULARLY.....	123
5.7.4 CLEANING OF COOLING SYSTEM.....	123
5.7.5 ENGINE AIR FILTER MAINTENANCE.....	124
5.6.5 ENGINE AIR FILTER MAINTENANCE.....	124
5.6.6 MAINTENANCE AND REPLACEMENT OF THE AIR FILTER ELEMENT.....	125
5.6.7 CLEAN DUST COLLECTION CUP OF THE AIR FILTER.....	127
5.8 USE OF FUEL SYSTEM AND RELATED MAINTENANCE.....	127
5.8.1 FUEL TANK CLEANING.....	127
5.8.2 FUEL OIL LEVEL INSPECTION.....	128
5.8.3 APPLICATION AND REPLACEMENT OF FUEL FILTERS.....	128
5.8.4 APPLICATION AND REPLACEMENT OF FUEL PRE-FILTERS.....	128
5.8.5 MAINTENANCE OF ENGINE OIL.....	129
5.8.6 REPLACEMENT OF ENGINE OIL.....	129
5.8.7 REPLACEMENT OF ENGINE OIL FILTER.....	130
5.9 INSPECT ELECTRICAL SYSTEM.....	130
5.9.1 INSPECT BATTERY.....	130
5.9.2 INSPECT ELECTRICAL DEVICES.....	131
5.9.3 SOLDERING.....	133
5.10 TRANSMISSION OIL MAINTENANCE.....	134
5.10.1 INSPECT OIL LEVEL OF GEARBOX.....	134
5.10.2 TRANSMISSION OIL REPLACEMENT.....	134
5.11 MAINTENANCE OF DRIVE AXLE OIL.....	135
5.11.1 INSPECT OIL LEVEL OF DRIVE AXLE.....	135
5.11.2 REPLACEMENT OF THE DRIVE AXLE OIL.....	136
5.12 INSPECTION AND REPLACEMENT OF TIRE.....	136
5.13 MAINTENANCE FOR LONG TIME PARKING.....	137
5.14 MAINTENANCE UNDER SPECIAL CONDITIONS.....	137
5.15 MAINTENANCE OF HYDRAULIC OIL.....	138
5.15.1 INSPECT THE OIL LEVEL OF THE HYDRAULIC OIL.....	138
5.15.2 REGULAR REPLACEMENT OF HYDRAULIC OIL.....	139
5.16 BUCKET MAINTENANCE.....	140
5.16.1 REPLACE BUCKET O-RING.....	140
CHAPTER VI COMMON FAULTS AND TROUBLE-SHOOTING.....	142
CHAPTER VII MAINTENANCE AND SERVICING OF AIR-CONDITIONING SYSTEM.....	147
CHAPTER VIII ENVIRONMENTAL PROTECTION REQUIREMENT.....	148
APPENDIX: REFERENCE TABLE OF PROPORTION OF COMMON MATERIALS.....	149

# CHAPTER I SAFETY PRECAUTIONS

## **Warning!**



Please read and understand all the safety precautions before operation. Failure to do so may result in severe bodily injury or death.

## **1.1 DESCRIPTION OF SAFETY SIGNS**

### **Danger!**



- 1) There exists danger that may affect your personal safety.
- 2) Don't operate the machine without permission. Any operation may affect the machine's normal conditions and cause machine damage or dangerous accident.

### **Warning!**



- 1) There exists potential danger that may affect the safety of you and others.
- 2) Don't operate the machine without permission. Any operation may affect the machine's normal conditions and cause machine damage or dangerous accident.

### **Caution!**



- 1) There exists potential danger that may affect your personal safety.
- 2) Please operate this machine according to instructions. Any improper operation or no operation may affect the machine's normal working conditions and cause machine damage.

## **1.2 DESCRIPTION AND LOCATIONS OF SAFETY SIGNS**

There are a number of safety signs on the machine. This section will give a detailed description of their locations and meanings. Please familiarize yourself about these safety signs before any operation.

If these signs are damaged, lost or illegible after cleaning, please replace them in a timely manner.

If any part bearing any safety sign has to be replaced, a new safety sign must be affixed onto the replaced part.



These safety signs must be kept clean. If the figures and words on these signs are unclear or illegible, please replace or clean them with soft cloth, water or soapy water. No solvent, gasoline or other irritating chemical agent may be used for this purpose.

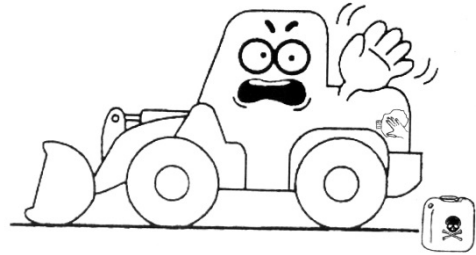

### 1.2.1 WARNING SIGN OF REVERSING

- Sign location: rear counterweight
- Contents: when driving the car backwards, the driver must pay attention to maintain a certain distance between the machine and surrounding staff to avoid accidents. When driving the car backwards, the driver must pay attention to the surrounding pedestrians and vehicles to avoid accidents.

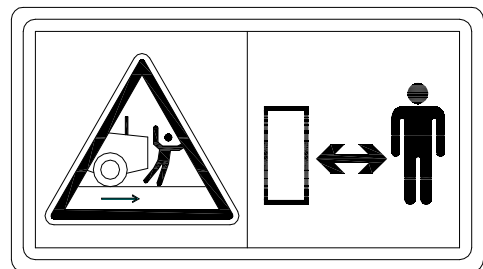

### 1.2.2 WARNING SIGN OF THE ANTI-FREEZE FLUID

- Sign location: on the engine hood.
- Contents: this sign reminds the user to operate the machine according to this sign. Otherwise, it may cause machine damage or personal injury.



### 1.2.3 WARNING SIGN OF MAINTENANCE AND TRANSPORTATION

- Sign location: left side of frame hinge joint
- Contents: it reminds the users to lock the frame with fixing rod before transportation and maintenance of machine, to avoid accidents. Dismount the fixing rod before the loader recovers its work, and place it in fixed location.

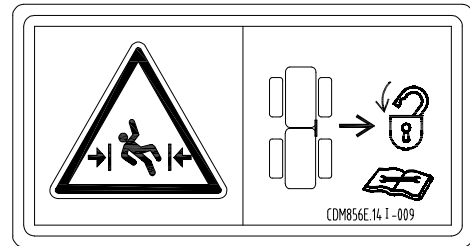

#### 1.2.4 WARNING SIGN OF LIFT ARM

- Sign location: front end of lift arm
- Contents: this sign reminds user that never permit persons to stand below the moving lift arm when operating lift arm to avoid accidents.

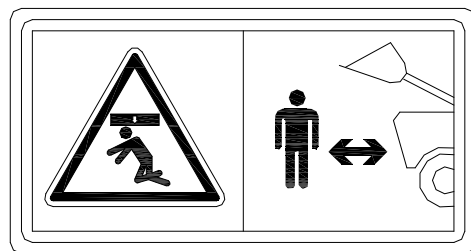

#### 1.2.5 SAFETY WARNING SIGN OF HINGE

- Sign location: in the front and rear hinging positions at the left side of the front frame
- Contents:

1. Danger of crushing! Do not stand here when the loader is turning, because the crushing may lead to serious injury or death.

2. Danger of crushing! During the transport of loader or the maintenance of hinge, the front and rear frames of the loader shall be locked in order to avoid dangers.

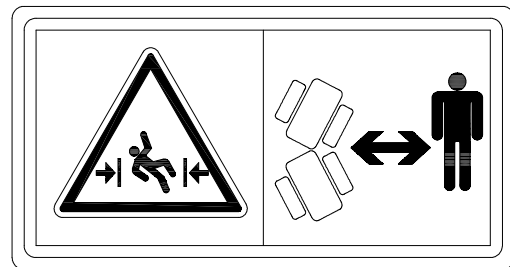

#### 1.2.6 WARNING SIGN OF FAN

- Sign location: at both left and right sides of the engine hood
- Contents: this sign reminds the user to open engine hood only when the engine stops in order to avoid severe injury

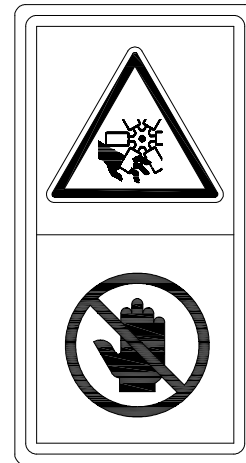

### 1.2.7 WARNING SIGN OF NO TRAMPLE

- Sign location: upper side of splash guard of front frame
- Contents: due to the limitation of bearing capacity of steel panel on splashguard, keep off here to avoid accidents.

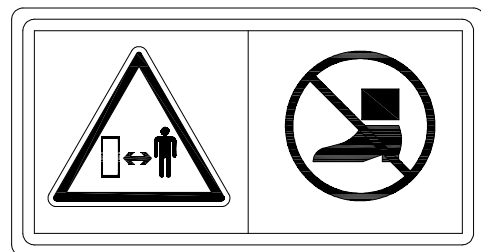

### 1.2.8 DISTRIBUTING DIAGRAM OF GREASE NIPPLE AND LUBRICATING POINTS

- Sign location: left side of the frame hinge
- Contents: distribution diagram of lubricating points by hourly calculation based on the requirements of machine. This sign reminds user to fill and change different lubrication oils at each lubricating point at scheduled time.

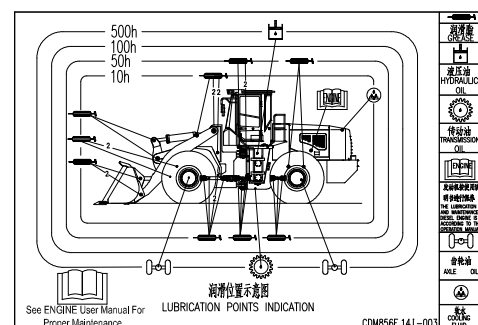

### 1.2.9 MACHINE NAMEPLATE

- Sign location: left side of the frame hinge
- Contents: description of basic information of the machine

LONKING 龙工		轮式装载机
特征		WHEEL LOADER
额定载重量 RATED PAULLOAD	kg	发动机型号 ENGINE MODEL
外形尺寸 EXTERNAL DIMENSION		
发动机功率 ENGINE POWER	kW	最高设计车速 MAXIMUM DESIGN SPEED
产品识别代码 PRODUCT IDENTIFICATION CODE		
配置代码 CONFIGURATION CODE	整备质量 WEIGHT	出厂日期 DATE OF MANUFACTURE
中华人民共和国		龙工(上海)机械制造有限公司

### 1.2.10 LIFTING AND BINDING SIGN

- Sign location: rear end of frame, near tire
- Contents:
  1. This sign reminds the user of the hanging position of the hook when the loader is lifted.
  2. This sign reminds the user of the binding position when the machine is shipped.

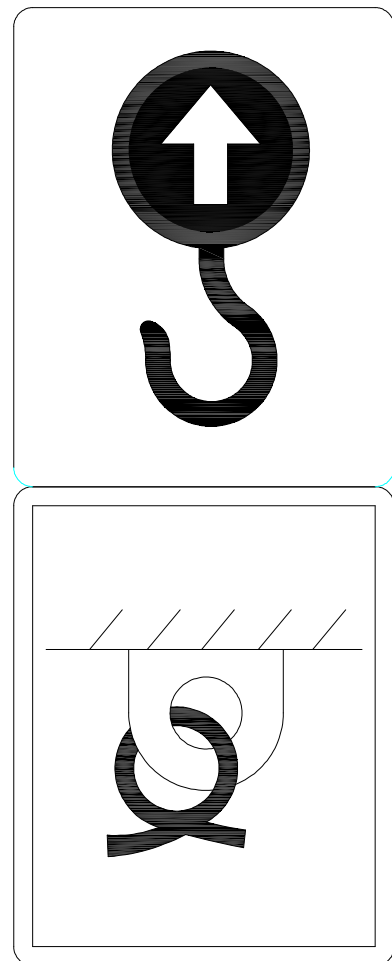

### 1.2.11 HYDRAULIC OIL SIGN

- Sign location: on oil tank at the left side of the frame
- Contents: this sign reminds the user that filled hydraulic oil shall be the oil product designated by LONKING or the hydraulic oil of the same type.

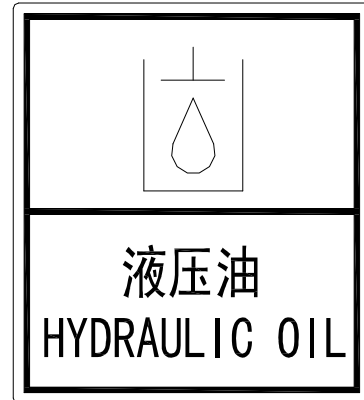

### 1.2.12 SCHEMATIC DIAGRAM OF USE OF TRIANGLE IRON

- Sign location: on the triangle iron fixing bracket of front fender
- Contents: this signs reminds the user that if the machine stops on the slope or tires need to be fixed to prevent tires from moving, it is required to comply with the contents of this sign. Otherwise, it may cause personal injury.

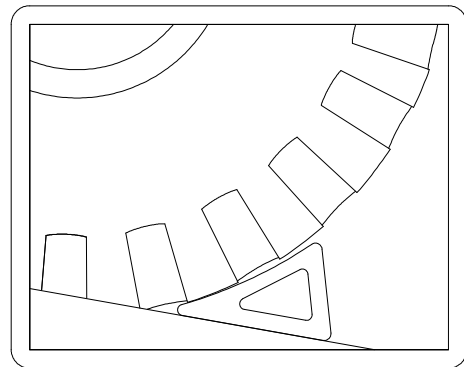

### 1.2.13 FUEL SIGN

- Sign location: oil tank at right side of the frame
- Contents: this sign reminds the user that the right side of the frame is fuel tank. Please fill the clean fuel commensurate with environment temperature.

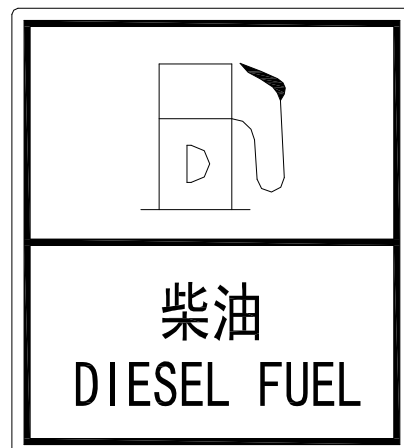

### 1.2.14 WARNING SIGN FOR SCRAPING

- Sign location: on the bucket
- Contents: this sign reminds the user that the permitted capacity of the bucket is less than the figure as shown on the sign. Otherwise, it will cause accidents.

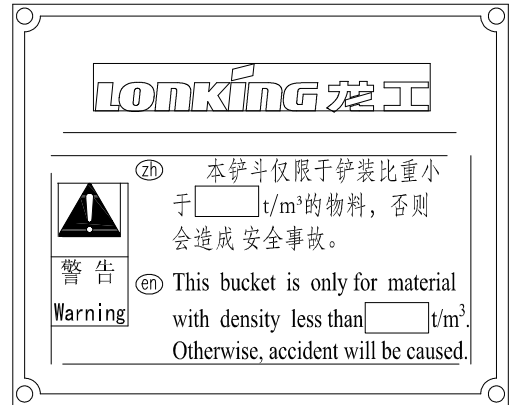

### 1.2.15 ATTACHMENT NAMEPLATE

- Sign location: on the bucket
- Contents: the description of the basic information of machine attachments.



### 1.2.16 SIGN OF FLUSHER CONTAINER

- Sign location: on the engine hood of the cab
- Contents: this sign reminds the user that this position is for flusher container. Please fill washing liquid as required after the machine is running for a period of time.



### 1.2.17 WARNING SIGN OF PREVENTING SINKING MOVEMENT

### 1.2.18 SAFETY EXIT SIGN

- Sign location: lift arm
- Contents: this sign reminds the user to operate the machine according to this sign. Otherwise, it may cause machine damage or personal injury.

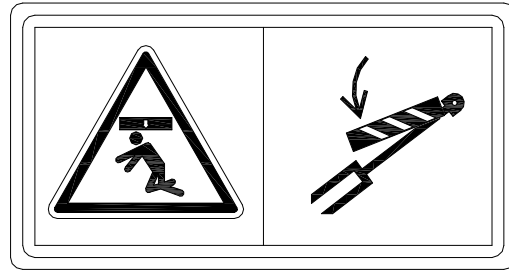

- Sign location: on the glass of the right door of the cab
- Contents: this sign reminds user that if the main exit is blocked, unhinge the latch and escape from the right door.

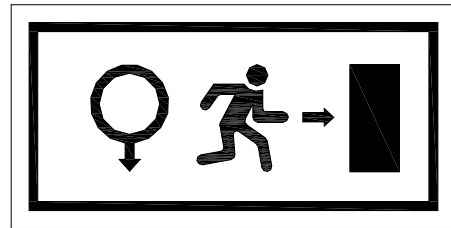

### 1.2.19 SCALDING WARNING SIGN AT HIGH TEMPERATURE PLACE

- Sign location: left and right sides of the engine hood
- Contents: because the working engine gives out large quantities of heat (maximum temperature of exhaust pipe is up to 500°C), the user must be careful when opening the engine hood so as to prevent damage to human body due to high temperature. If possible, wear the high temperature-resistant gloves so as to avoid scalding.

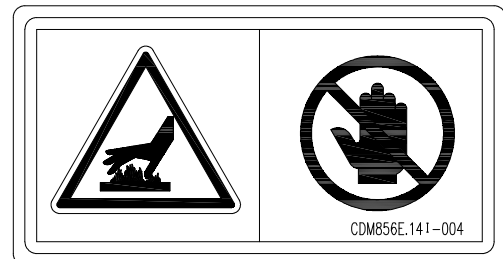

### 1.2.20 REMARKS FOR LONG TIME STANDSTILL

- Sign location: on rear hood
- Contents: this sign reminds the user to operate the machine according to this sign. Otherwise, it may cause machine damage or personal injury.

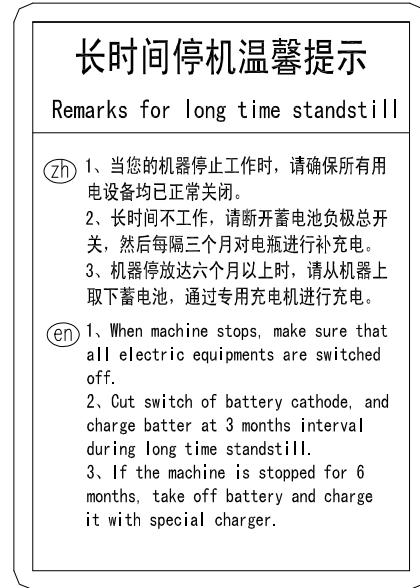

### 1.2.21 SIGN OF BATTERY CONNECTING WIRE

- Sign location: rear side of engine hood
- Contents: this sign gives a description of method and precaution for battery wiring. Please install battery wiring according to the instructions of this sign.

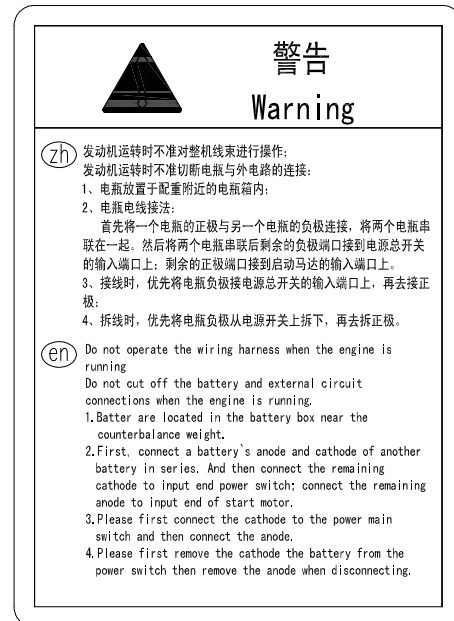



## 1.2.22 COMBINATION OF WARNING SIGNS

·Sign location: on the right front column in the cab

·Content of signs:

1. This warning sign reminds the user to read all items described in this instruction book. Violating this instruction book or ignoring the warning may lead to casualties, and the driver must strictly obey the operating specification.
2. This warning sign reminds the user to rotate the fan support while turning on the heating supply in cold weather. Turn on the fan to blow at the front windshield to prevent blurred vision due to formation of mist on the glass.
3. This sign reminds the user to operate the machine in strict accordance with the contents of the sign; otherwise the machine may be damaged.
4. This sign reminds the user to turn off the cathode switch of storage battery while performing the welding operation on the machine; unplug the plug connector linking the wire harness to the engine controller before unplugging the plug connector of the electrically-controlled transmission control system; since the operation involves numerous factors, the user is advised not to perform welding operation on the machine arbitrarily; such operation shall be performed under instructions of professional personnel for fear of an accident.
5. The warning reminds the user to operate the machine in strict accordance with the contents of the sign; otherwise machine damage or personal accident may occur.
6. This warning sign reminds the user to use parts dedicated for Lonking loaders during replacement of parts; otherwise machine damage or personal accident may occur.
7. This warning sign reminds the user to use oil dedicated for Lonking loaders or equivalent oil recommended in this instruction book during oil replacement; otherwise machine damage or personal accident may occur.

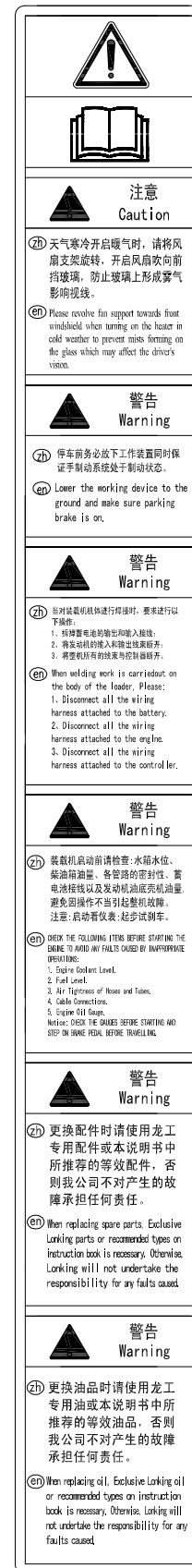

## 1.3 UNAUTHORIZED MODIFICATION

Any modification of this machine not authorized or approved in writing by LONKING may cause safety accidents. The owner shall bear all the consequences.

For the sake of safety, please use correct grade and genuine fitting and oil. If without correct fittings or periodically fasteners change, the parts may exceed safety use limitation.

## 1.4 GENERAL SAFETY PRECAUTIONS

### 1.4.1 SAFETY REGULATIONS

Only those who experienced special training or got equivalent qualification can operate or maintain this loader.

Strictly follow the requirements of safety regulations, warnings when operating or maintain this loader.

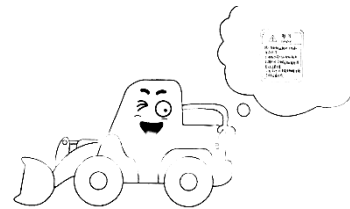

Never operate or maintain the loader when you feel bad, tired due to dose, after drinking, or do not adapt to environment, because it may reduce you emergency reacting capacity and commission error, which may cause accidents.

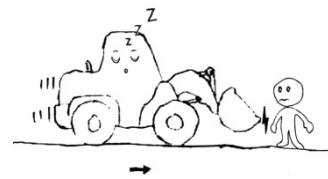

When working with operators or site traffic commanders, make sure all persons are familiar with the using sign language.



Observe the surrounding safety influence factor at any instant.

Follow related safety regulations.

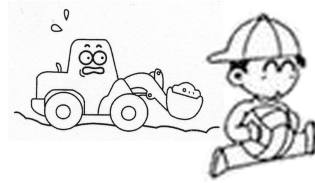

### 1.4.2 PROTECTIVE DEVICES

Make sure all protective devices and engine hood is in proper location, if there is damage, timely repair it.

Please correctly use protective devices such as joystick locking device, safety belt etc. never demount protective devices and make sure they are in good working condition. Incorrect use of protective devices may cause casualty accidents.

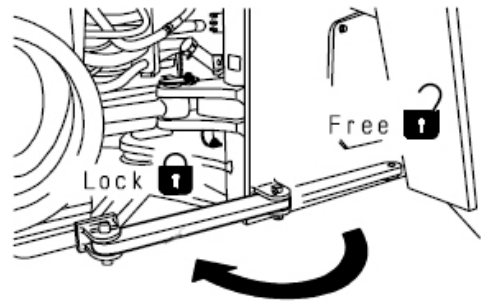

### 1.4.3 SAFETY PRECAUTION FOR INTERNAL CAB

Before entering cab, remove mud and oil dirt sticking to shoes bottom. Otherwise, it may cause an accident due to skidding when trampling the accelerator pedal or brake pedal.



Do not adsorb suction cup stick on the cab glass, for the lens action of suction cup may cause fire accidents.

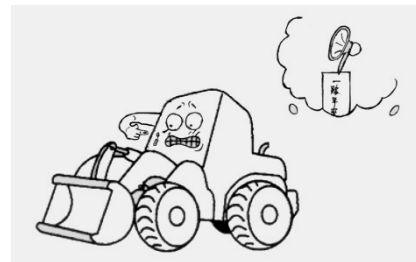

Do not randomly lay the lighter or match inside the cab, because it may cause lighter blasting if the cab temperature is high.



Do not use mobile phone when operating the loader, because distraction may cause accidents.

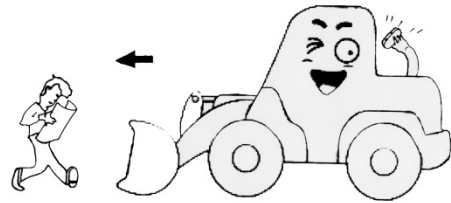

Do not take any flammable and explosive hazardous article into the cab.



Do not wear earphone or headphone when driving or operating the loader, otherwise it may cause accident. Do not put head or hand out of windows.



Before leaving the loader, lower the working device down to the ground, lock up the protective devices, shut down the engine, lock all devices, unplug keys and take with them.



#### 1.4.4 WORKING CLOTHES AND PERSONAL PROTECTIVE EQUIPMENTS

Avoid wearing loose clothes and ornaments or other things that may hook control level or other machine parts, for they may be blocked or engulfed in control system or moving parts, and cause severe injuries or casualties.

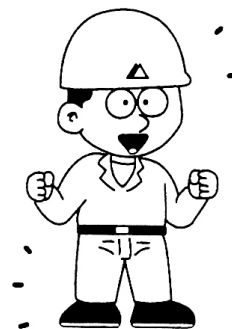

Do not wear greasy clothes to avoid catching a fire.

Wear safety helm, glass, shoes, mask and gloves before operating or maintaining the machine.

Wear safety dust goggles, Safety Helmets and thick gloves when working in conditions of metal pieces or slight sundries, especially when nail pin with hammer or clean air filter impurities with compressed air, and make sure no person approaches the machine.

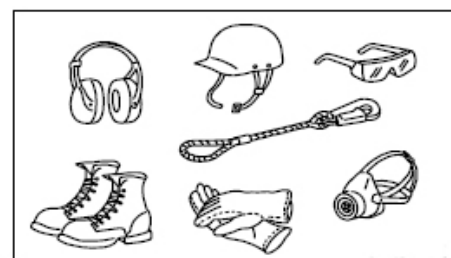

Compressed air may cause human injuries; there

fore, it is important to wear mask, protective clothes and safety shoes before using the compressed air. The maximum pressure of compressed air using clean shall be under 0.3MPa.

Check whether all protective equipment are in normal work conditions.

### **1.4.5 GETTING ON AND OFF THE MACHINE**

Before ascending or descending machine, clean oil dirt, lubricant or mud, furthermore, repair damaged parts and tighten loose bolt.

Do not jump on or off the machine, either when it is at rest and when it is moving.

When ascending or descending the machine, you shall face to the machine, hold armrest, step on ladder and keep three points contact (two feet and a hand or two hands and a foot) to make sure body balance and stable.

It is prohibited to hold control level when ascending or descending the machine.

It is prohibited to cab from back of machine or descend machine by stepping side tires.

When ascending or descending machine, it is prohibited to take any tools or other things.

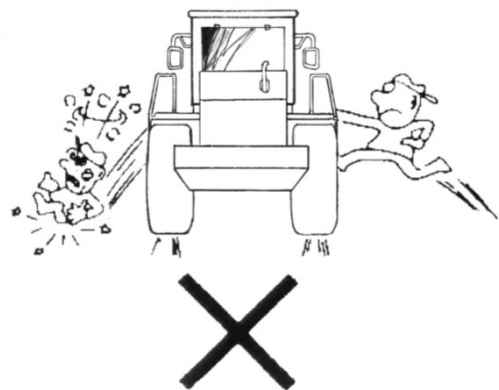

### **1.4.6 FIRE PREVENTION OF OIL PRODUCTS**

Please use fuel, oil and hydraulic oil used in hydraulic system to fill diesel engine of this loader, hydraulic transmission oils and gear oils used in transmission system and brake fluid used in brake system and antifreeze used in engine water tank can be lit by open fires, in particular, fuel is flammable and dangerous, therefore, the following Safety and accident prevention must be noted:

Be sure to keep flame away from the flammable liquid.

Fill these flammable liquids in a well-ventilated place, shut down the engine, and do not smoke.

Tighten storage lid of above combustible liquids.

Store the above flammable liquids in containers marked with corresponding logos and lay them in a specified place to give a classified storage and prevent non-staff person use them.

Lay the rags stained with oil or other flammable materials in a protective container and put them in a safe place.

Do not use electric weld or flame cut pipeline or container containing flammable liquids. Prior to electric weld or flame cut, use non-flammable liquids clean the welding or cutting place.

Clean up the combustible materials accumulated on the machine such as fuel, lubricants, or other debris.

Do not lay the machine in flame, burning bushes places.

This wheel loader is ordinary construction machinery; do not operate it under flammable and explosive environment.

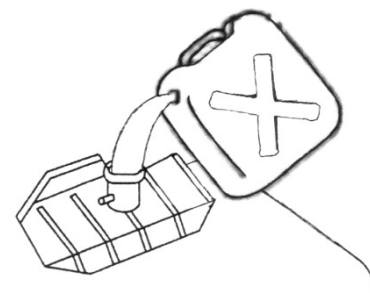

### 1.4.7 PRECAUTIONS WHEN OPERATING AT HIGH TEMPERATURE

When the operation of machine has just completed, temperature of hydraulic oil, oil and water inside engine and radiator is still high, and the pressure still exists. At this moment, open fuel tank cap, radiator cap, pour oil or replace filter are likely to cause serious burns. Therefore, carry out those operations according to specified procedures after the temperature dropped.

In order to prevent hot water spray out, the engine should be close to make the water cool down, release the pressure slowly when opening the engine cover. (Check whether the water temperature has reduced by testing the air temperature with hand close to oil radiator. Be careful not to contact with radiator.)

In order to prevent hot oil spray out, the engine should be shut down so as to let the oil cool down, slowly loosen the cap to release the pressure when opening the engine cap. (Check whether the oil temperature has reduced by testing the air temperature with hand close to the front of the oil radiator. Be careful not to contact radiator.)

In order to avoid scald, do not touch relay when the engine is hot.

Do not detach temperature sensor of engine oil, water sensor, torque converter sensor and A/C pipelines to avoid burnings.



#### 1.4.8 PROTECTION OF ASBESTOS DUST HAZARD

Inhalation of asbestos dust may be harmful to body health.

The products produced by LONKING Holdings Limited do not include asbestos, but if you contact with materials containing asbestos fibers, please follow the below rules:

It is protective to use compressed air for cleaning.

Please use water to clean so as not to stir up the dust.

It is dangerous if the air containing asbestos dust, if possible, operate the machine in the uptake.

If necessary, use qualified dust mask.

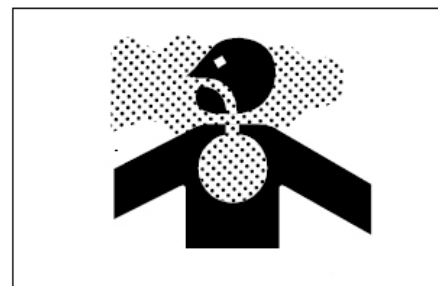

### 1.4.9 FACE MASK AND EARPLUG

Never ignore the dangerous factors that may not be harmful to body health at present. Exhaust gas and noise is unseen, but it may cause disability or permanent injury.

### 1.4.10 FIRE EXTINGUISHER AND FIRST-AID KIT

In case of personal injury or fire, please take aid actions according to the following measures:

Fire extinguishers must be equipped. Read carefully the instructions for use, and know how to operate it.

First aid kit must be equipped in site, periodically check it and timely added medicines. Know what to do when a fire or injury happened.

Some staff's phone numbers (such as doctors, first aid center, fire station, etc.) are well prepared, so that you may contact them in case of emergency. Stick those phone numbers to a specified place to make sure all staff are aware of those numbers and know the correct communication methods.

If fire breaks out during the operation of machine, please follow the below requirements for danger escape: turn off the starter switch, shut down the engine, if condition permits, take fire extinguisher for quelling a fire. Escape from machine through the escalator.



### 1.4.11 PREVENTION OF ROLLING INJURY OR CUT OFF

It is protective to enter or place your hands or any other body parts between movable parts, such as between working device and oil tank and between machine and working device. With the movement of working device, the space of connecting rod may increase or decrease, it may cause serious injury accidents if you close to it. Therefore, if you want to get close to the moving parts of the machine first shut down the engine and lock up working device.



Properly support equipment or accessory when working underside the machine. Do not rely on hydraulic cylinder for supporting. If the control



mechanism moves or hydraulic pipeline leaks, any attachment will fall off.

Unless otherwise specified, make no adjustment when the machine is operating or the engine is starting.

Be sure to keep away from all rotating and moving parts.

Be sure that there is no debris in the engine fan blades.

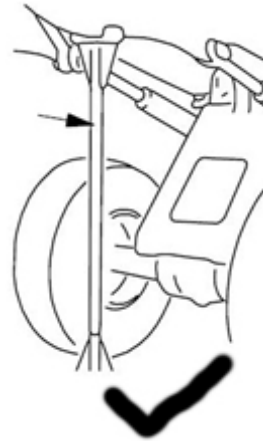

#### **1.4.12 ETHER (IF YOUR MACHINE IS EQUIPPED WITH ETHER COLD STARTING DEVICE)**

Ether is toxic and flammable, inhalation of ether vapor or frequently contact it with skin may cause injury. When using ether, make sure the place is in good ventilating conditions and pay attention to prevent fire. Do not smoke when replacing ether cylinder.

Do not store ether cylinder in living areas or inside the cab. Do not put ether cylinder in an area of direct sunlight or the place where the temperature is more than 39°C (120°F).

Please put the waste ether cylinder in a safe place, do not perforate or burn it.

Lay the ether cylinder away from non-staff areas.

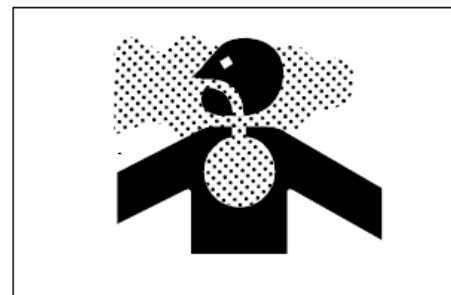

#### **1.4.13 MAKE SURE A GOOD VENTILATION WHEN OPERATING IN AN ENCLOSED SPACE**

If it needs to start the engine or handle fuel, clean parts or paint in an enclosed or bad ventilated place, open the doors and windows to ensure that this is adequate ventilation to prevent gas poisoning.

If the opening doors or windows still cannot offer an adequate ventilation condition, please install a fan.

#### **1.4.14 PIPELINE, HARD PIPE AND FLEXIBLE PIPE**

Do not bend or hammer high-pressure pipeline, do not install abnormal bending or damaged pipe or tube on the machine. Repair loose or damaged fuel and lubricant pipeline and pipe or tube installed in hydraulic system.

Leakage may cause fire. For repair or replacement, please contact the designated dealer of LONKING Holdings Limited.

Please carefully check all pipelines, hard pipes and flexible pipes, tighten all joints according to specified tightening torque. Do not check the leakage with bare hands, but check them with board or cardboard.

Even a pinhole size pressure liquid leakage may penetrate muscle and cause death. If the solution sprays out to the skin, please contact with surgeons who is familiar with this injury for cure within a few hours. If the following faults happened, the parts should be replaced:

- 1) connector damaged or leaked;
- 2) outer layer of the tube worn or cut and strengthening steel wire bare;
- 3) local uplift of the tube;
- 4) the tube has obvious torsion or deflection;
- 5) strengthening steel wire of the tube embedded in outer layer;
- 6) end connector dislocation.

Make sure that they has been installed correctly such as all pipe clamps, protecting plates and heat resistant cover to avoid shock or overheating due to the friction with other components.

When removing connecting pipe of A/C compressor, no open fire closing, otherwise it will produce toxic gases and cause poisoning.

### 1.4.15 COOLANT

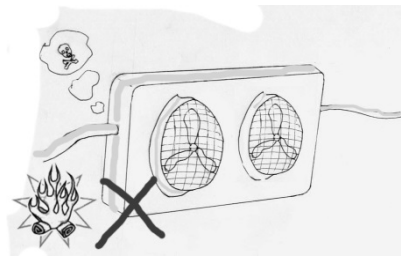

When operating, the engine coolant temperature and pressure are high. All pipelines leading to radiator or engine has hot water and steam, touch them will cause serious burn.



When checking coolant level, the engine should be shut down and add cold water to let it cool until the bare hands can be used to open the outlet cover.



Slowly screw the filler cap of cooling system to release pressure.

Because the coolant of cooling system containing alkali, it is forbidden to contact with skin or eyes and drink.

Cool the coolant before exhausting it.

#### **1.4.16 PROTECTION FROM FALLING OR FLYING OBJECTS**

When there is falling or flying objects hit the cab at site, it will cause danger, please select the protective device that is suitable to operating condition to protect driver.



When working at mines, tunnels, deep pit, soft or wet surface, it may exist hitting danger of falling rocks or flying objects. It is necessary to install protective devices in the cab, and the installation must comply with the requirements of FOPS (falling objects protective devices) and glass protection.



Prohibit the use of strengthening devices, such as drilling and welding on the protective device.

If the protection device is seriously impacted or damaged, its strength is lowered and its normal functions cannot be reached, please contact the designated dealer of LONKING Holdings Limited for consultation repair method.

When using breaker for operation, install a protective device on the front windshield. Please contact the designated dealer of LONKING Holdings Limited for recommendations.

If any glass of the machine is damaged, please

replace with a new one immediately.

## **1.5 SAFETY PRECAUTION OF OPERATION**

### **1.5.1 SITE SAFETY**

Before starting the engine, carefully check whether there is any abnormal condition around the engine leading to dangerous situation.

Check the site landform and ground condition; determine the best and safest operation method.

Shovel and level the ground into a solid and plane state before the machine is in operation, in case of heavy dust at site, spray water before operating.

In case of operating at a street, there should be a special person to direct traffic, or set a fence or put up a sign of “no entry” around the site.

Any objects around lift arm are potentially dangerous, or make the driver unprepared that may cause accidents. When operating in bridge, cable lines, or there are scaffoldings or other barrier accessories, need the special commander.

Insurance coverage, operating license or certification, minimum standard protection or limitation of operating hours of obstacles around working environment that may be authorized or decided by government authorities. Please follow local required regulations, guidelines, standards or equipment limitation conditions and relevant provisions of implementation of specified work. If you want to know whether your machine and site circumstance is compliance with environmental laws and regulations, please consult the local authorities or relevant departments.

Soil piled on the ground or on the side of ditch is very soft and sloppy; the vibration of the machine may collapse the soil, causing tip-over accidents.

For the place with buried facilities, such as water pipe, gas pipe, telephone line or high voltage line, please contact the responsible company to determine the location of buried facilities, and note that do not damage these facilities during construction.

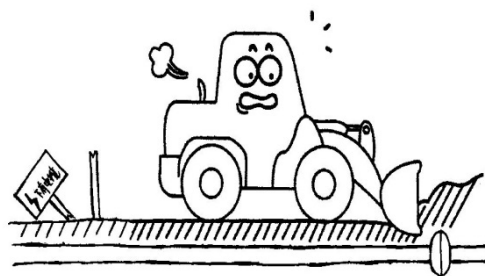

First, check ground conditions, water depth and flow rate when operating on water or sandy embankment. Do not exceed the allowable water depth.

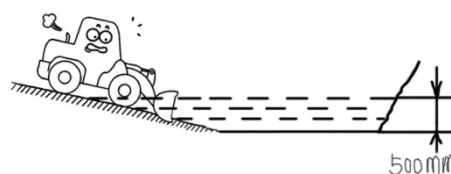

Do not drive or run the machine on the soft road, otherwise, the machine may be difficult to leave.



Avoid operating on the cliff edge, suspended material or deep pit, if the ground collapsed, the machine crashed or upset, which may cause serious casualties. Especially after raining, do blasting operations or after earthquake, the soil is very soft and sloppy and prone to cause danger.



Please install head protection devices for operation on dangerous areas where there are falling stones.



## 1.5.2 CHECK BEFORE ENGINE START-UP

Prior to operation, check the following items before the engine start-up. Otherwise, it may cause serious injuries or damages.

Check whether there are leakages of fuel, oil or hydraulic oil.

The operator shall not leave parts and tools around seat, because those things may fall and cause damage to joystick or switch due to the machine's traveling and vibration during operation, or it may lead to joystick moving or working devices running and cause an accident.

Before ascending the machine, the operator shall remove all sludge and fine sand stuck on the shoes, because the sludge may accumulate on the accelerator pedal and brake pedal that will affect the reset of pedal. If these places accumulate sediment on the pedal, you should remove it immediately.

Check the level of coolant, fuel and oil of engine oil pan, check whether air filter is blocked and cable is damaged.

Adjust the operator's seat to the location where is convenient to operate machine, check whether the positioning device of seat belt and safety belt is damaged. Service lift of the safety belt is over 3 years and replaced

Check whether the instruments are in normal working condition, and whether the joystick is in parking position.

Clean the window glass and light in the cab to ensure a good visibility.

Adjust the location of rearview mirror to ensure the operator has best vision when setting down the cab seat. Clean the surface of the rearview mirror. If the rearview mirror glass has damaged, replace it.

Check whether the front lamp and working lamp are in normal working conditions. If they are not in normal conditions, repair them.

Check whether there are flammable materials around engine or battery

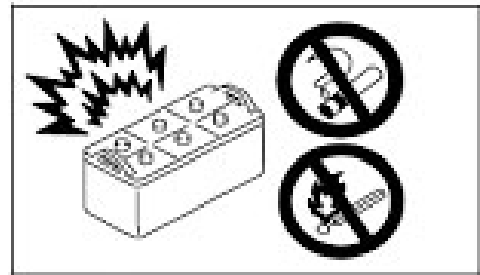

Check whether the rearview mirrors, armrests and ladders have stained by fuel.

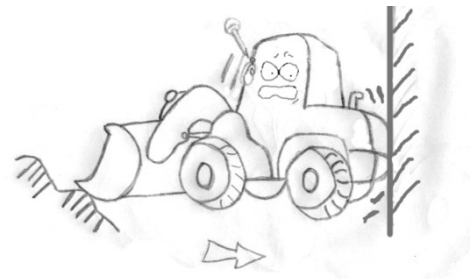

Make sure there is fire extinguisher, and the operator must be familiar with use methods.



Do not place the machine close to a place where there is open fire.

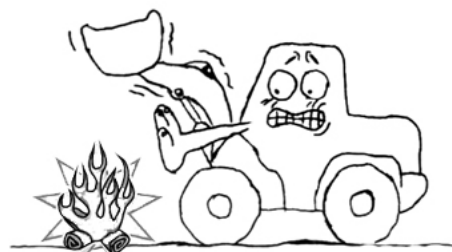

### 1.5.3 ENGINE START-UP

Before ascending the machine, visible inspect your machine, check whether there are persons and objects on, off, or near the machine or on the working area.

If the machine has not used for a long time or the operating temperature is extremely low, please maintain your machine before start up.

Check whether all instruments and monitor displays are in normal condition before starting the engine. Note whether there is noise and potential unsafe factor when running the engine.

You can start the engine only in the cab. Strictly prohibit starting the engine with starter motor short-circuiting. Otherwise, it may cause damage to the machine's electrical system, and this operation itself is very dangerous.

If there is a sign of “do not operate” on the joystick, do not start the engine or pull the joystick

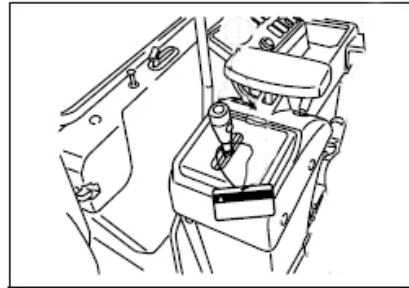

When starting the engine, please ring the horn for warning.

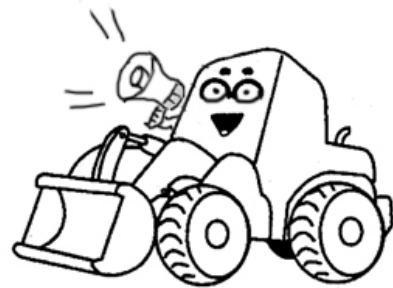

Only when the operator sitting down to the seat that can start and operate the engine. Make sure there is nobody in the cab except the operator. **It is not allowed that anyone sit down on the body of the machine.**



If a reversing alarm device is installed, make sure it is in normal working condition.



#### **1.5.4 CHECK AFTER ENGINE STARTING UP AND BEFORE MACHINE OPERATION**

If there is no proper and timely check after the engine starts up, it is likely that the abnormal condition of the machine cannot be identified in time, thus causing personal injury or machine damage.

Check work shall be performed in a spacious place where there is no obstruction. No other person is allowed to approach the machine during checking.

Check whether the instruments and equipment, bucket, lift arm, brake system, power train system and steering system are in normal working conditions.

Check whether the sound, vibration, heat, smell or instrument are in abnormal conditions; check the leakage of hydraulic oil, lubricant, gas or fuel.

If any abnormal condition has been identified, please immediately adjust or repair it to normal condition. Otherwise, it may cause injury accidents or machine damage.

Before the machine is traveling or working, check the frame fixing rods that are used to lock front and rear frames, the frame fixing rods should be in a position of "release".

Before operating the machine, heat the oil of engine, hydraulic tank and torque converter to normal working temperature.

Remove all obstacles on the machine's running path.

Keep window clean, and make sure all windows are in a safe opening or closing position.

Adjust the rearview mirror to the best field vision, make sure horns, alarms and other warning devices are in a good working condition.

#### **1.5.5 PRECAUTIONS WHEN THE MACHINE BEGINS TO TRAVEL**



Before operating the machine, again check the states around the machine, make sure there is nobody and obstacle there.

When the machine is running, sound the horn for warning.

Only when the operator sitting down to the seat that can start and operate the engine. Fasten the safety belt.

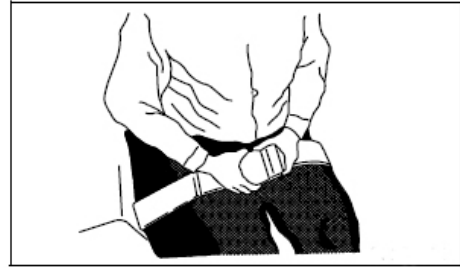

Nobody except operator shall enter the cab.  
**Nobody is allowed to sit on the external body of the machine.**

It must be made sure that the back-up buzzer works properly.



### **1.5.6 PRECAUTIONS WHEN THE MACHINE IS TRAVELING**

Do not turn the starter switch to the “OFF” position when the machine travels. If the engine suddenly stops during the traveling, it is very dangerous, because it will cause hard steering. If the engine stops, perform braking to stop the machine.

If the machine is detected having any abnormal conditions during operating (abnormal status of noise, vibration, smell and instrument display, gas or oil leakage), immediately drive the machine to a safe place for check.

Do not suddenly turn the steering wheel, because the sudden turning will make the working device collide with the ground that may cause the machine to lost its balance, or damage the machine or buildings around it.

Lower speed when running on an uneven road and do not suddenly turn the steering wheel.

Try to avoid running over barriers, if it is necessary for the machine to moving across a barrier, lower speed and let the working device close to the ground.

Keep distance with other machines or building structures to avoid collision during traveling or operating.

Right and left glance is dangerous when operating the machine; therefore, the operator shall concentrate on his work.

Too fast traveling, sudden start, sudden stop, sudden turn or zigzag traveling is dangerous.

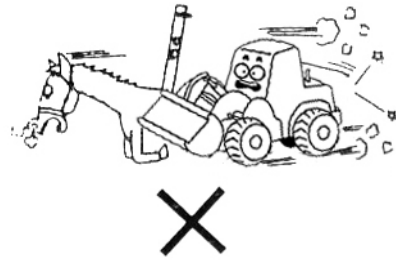

Adjust the height of working device below the lift arm and keep a clearance of 500-600mm (20-24in) from the hinge pin and ground, let the machine travel on the level ground. Do not operate the joystick of the working device during running. If it is necessary to operate the joystick of working device, first stop the machine and then operate the joystick.

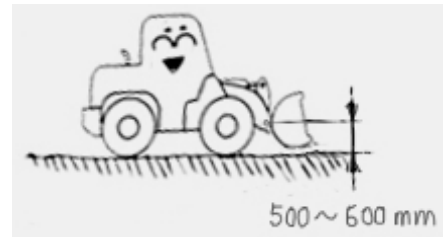

If the working condition is in water condition, it shall not exceed a permitted depth.

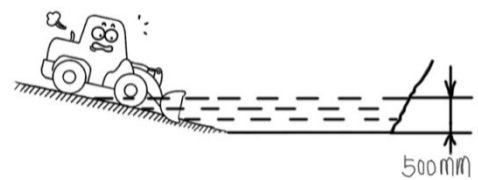

When passing through a bridge or private structures, check whether their bearing capacities can support this machine. When walking on public road, firstly it shall be in comply with the provisions of related authorities and traffic laws and regulations. The highest speed of this loader should be lower than the normal speed of a car. Walking in the aside road, leave the center of the road to other vehicles.



If this machine has run at a high speed for a long time, its tire will be overheated, and its internal pressure becomes extremely high. It may cause tire to blow up and produce great destructive power, and then may cause serious injuries or accidents.



### 1.5.7 CHECK WHEN CHANGING DIRECTION

In order to prevent injury or death, even though the machine is equipped with a backup alarm and rearview mirror, you must comply with the following rules before moving the machine or its working devices.

Sound the horn to warn the staff and person in the field.



Check the vicinity of the machine to ensure that there is nobody. Pay special caution to check the back area of the machine, for this area is unclear to see from the operator's seat.

It is necessary to designate a person to direct site traffic when the operating place is danger or has bad visibility.

It is not allowable to enter in the turning area or in the walking area of the machine.

Do not change direction when the machine is walking at high speed.

### **1.5.8 PROHIBITED OPERATION**

In order to prevent machine upset or working device damage due to overload, the load of the machine must maintain within the specified maximum value. Do not exceed the specified capacity.

It is not allowable to dig the operation surface beneath the upland; otherwise, it may cause the upland collapse and smash the top part of the machine.

It is not allowable to dig the ground deeply in front of the machine, the collapsed soil may cause the machine crashed.

It is dangerous to work on the soft, uneven or cracked road, and may cause the machine crashed. It is also dangerous to walk with imbalanced load and non-load.



### **1.5.9 PRECAUTIONS WHEN TRAVELING ON THE SLOPE**

Be careful that the machine may dump or skid to one side when traveling on the slope.

When an emergency happens, lower the bucket to the ground to help to stop the machine.

Do not travel on grass, fallen leaves or wet steel plate surface at a high speed. Even a small slope may cause the machine to skid to one side. Therefore, it is required to drive

machine at a low speed. The machine must move straight up and down when traveling on the slope.

When the machine travels downhill, never shift gear or place the gear in a “neutral” position. It is dangerous not to use the braking force of the engine. When the machine begins to travel downhill, the gear has to be placed in a “low” position.

When the machine travels downhill, the braking force of the engine has to be used so that the machine travels at a low speed. If necessary, when the braking force of the engine is used, the braking pedal is also used to control the travelling speed.

If the engine stops during traveling on the slope, immediately step full brake pedal to exert braking, lower bucket down to the ground, and then use parking brake to fix machine’s present position.

If the bucket is loaded when ascending or descending, you should make the bucket toward uphill direction (that is, forward for uphill traveling, backward for downhill traveling). Otherwise, the machine may have a risk of tip-over.

Keep a clearance of 20-30cm from the bucket to the ground when traveling on the slope.

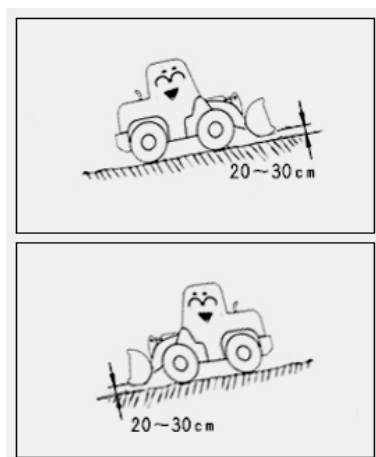

Do not turn direction or walk transversely on the slope, to complete this operation, the machine should be driven down to the even ground.

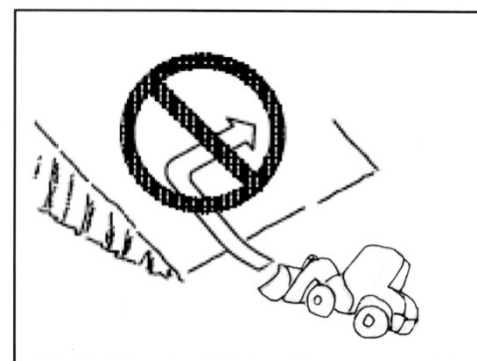
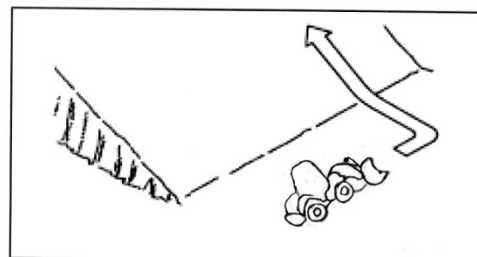

### 1.5.10 BEWARE OF HIGH VOLTAGE CABLES

Do not let the machine touch the overhead cables, even near the high voltage cable can cause electric shock. Keep a safe distance between the machine and cable as shown in the following table.

For the prevention of accidents, please perform the following tasks:

When there is a danger of touch the cable during operation on site, consult the power company before the start of operation, examine the feasibility of this operation based on the existing relevant laws and regulations.

Wear rubber boots and gloves. Lay a rubber mat on the operator's seat and be careful not to let any part of the body touch the exposed part of the metal chassis. Designate a signal commander who sends warning signal if the machine is too close to the cable.

If the working device touched the cable, the operator shall not leave the cab.

When operating near the high voltage cables, do not let anyone close to the machine.

Prior to operation, consult the local power company for inquiring about cable voltage.

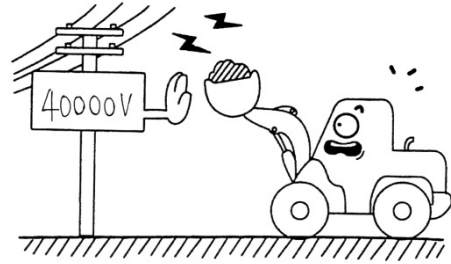

Voltage value (kv)	Minimum safe distance (m)
0.1-0.2	2
6.6	2
22	3
66	4
154	5
187	6
275	7
500	11

The minimum safe distance listed in this table is for reference only. Rainy or high voltage conditions will greatly reduce the safe distance.

## 1.6 PRECAUTION FOR OPERATION

When the machine shoves the soil descending a cliff or onto the peak of the slope, the load will suddenly become lighter. In such case, due to a sudden increase in walking speed, it is dangerous; therefore, it is important to reduce the speed.

When the bucket is full, do not give the machine a sudden start, turn or stop.

Do not get close to the edge of a cliff.

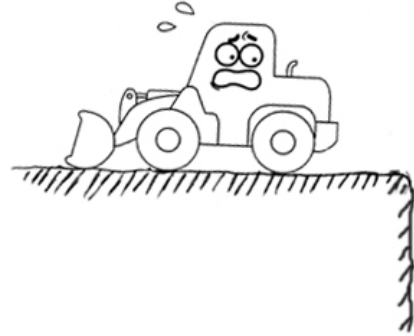

When loading unstable objects, such as round or cylindrical objects, layered plates, if the working device lifts, the loading objects may fall down to the top of the cab, and cause serious injuries or damages. Therefore, note that do not lift the working device too high or heavy tilt bucket backward.

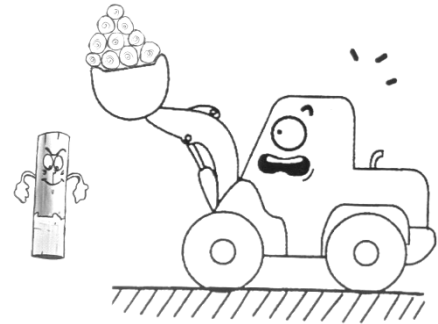

If the working device suddenly dropped or stopped, its reaction force may cause the machine overturning. Be careful to operating the working device, especially when it is loaded.

For a good visibility, please pay attention to the following tips:

- When operating in a dark place, turn on the switch of working lamp and headlamp; if necessary, install illumination equipment on site.
- Do not operate the machine in foggy, obscure, snowy or heavy rainy days or other poor visibility conditions until there is sufficient visibility for operation.

For collision prevention of working device with other objects, please pay attention to the following tips:

- When operating in tunnel, under the bridge, wire or other height limitation places, pay caution not to let the bucket hit anything.
- When use dump truck to load, check whether there is anybody around the dump truck, pay caution not to let the bucket of dump truck hit driver's cab. In order to prevent collision with other objects, and cause accidents, the machine shall operate at safety working speed, especially in limited spaces indoor and other areas with many vehicles.

## **1.6.1 METHODS OF USING A BRAKE**

Do not put your feet on the brake pedal unless it is necessary.

Do not frequently step the brake pedal unless it is necessary.

When walking down hill, take the engine as a brake, never use gear shifting or place the gearbox in neutral position.

## **1.6.2 PRECAUTIONS WHEN OPERATING ON SNOWY DAYS**

When the machine working on the snowy or icy road, even a small slope can make the machine slide aside, therefore it is important to low the walking speed and avoid a sudden start, stop or sharp turn, because it has danger of sliding, especially when the machine is in uphill or downhill status.

On the freezing road, when the temperature rises, the ground will become soft, so the walking condition will become unstable, in this case, be careful to operate the machine.

After heavy snow, the objects on the road shoulders and roadside were buried in the snow and unclear to see, so be careful to wipe the snow.

When walking on the snow-covered slope, it is not completely exert a sudden brake. To slower the speed, it is correct to use engine as a brake, meanwhile, step the brake pedal for several times. If necessary, lower the bucket down to the ground to stop the machine.

The adhesion force of the ground may greatly change with the effects of the snow. Therefore, it is necessary to adjust loading capacity to avoid machine sliding aside when walking.

The machine shall be equipped with anti-skid tire chains when walking on the snow-covered road.



## **1.6.3 PRECAUTIONS FOR OPERATION IN COLD AREAS**

After the completion of operation, clean off the water, snow or mud that clung to wires, cable connectors, switches or sensors, as well as covering parts.

Totally preheat the machine. Prior to the operation of joystick, the machine will response slowly if it is not totally preheated, this may lead to unexpected accidents.

Operate all joysticks to circulate hydraulic oil in hydraulic system (increase the system pressure to a specified value, then release the pressure, drain the oil to hydraulic oil tank)

which can warm the hydraulic oil to ensure that the machine is sensitive and prevent function failure.

If the electrolyte of the battery has frozen, it is dangerous to charge the battery and use other power supply to start the engine, because it may cause fire. If it is necessary to charge or use the other power supply to start the engine, unfreeze the electrolyte of the battery and check whether there is any leakage.

#### **1.6.4 DO NOT OPERATE THE MACHINE ON SOFT GROUND**

Do not operate the machine on soft ground.



Do not let the machine close to the edge of a cliff or its hanging parts and deep pit.



When the soil piled on the ground and near the ditches is loose, it may collapse under the weight or vibration of the machine, thus causing the machine to roll over..

When there is any danger that causes the machine to roll over at the worksite, ROPS shall be installed and safety belt shall be fastened.

When there is any danger of falling stone or any danger causes the machine to roll over, ROPS and FOPS shall be installed and safety belt shall be fastened.



#### **1.6.5 PRECAUTIONS WHEN PARKING THE MACHINE**



Park the machine on the even ground, and then lower working device down to the ground where there should no falling rocks or sliding danger, and there also should no flood if it is low terrain.

If it is necessary to park the machine on the slope, place a wedge under the wheels to prevent the machine moving, and then drop the working device down to the ground.

When parking the machine on the road, it is necessary to set up fences, signals, flags or warning lights and other necessary signals to ensure the machine can be seen clearly. However, the machine, fences and flag shall not affect other vehicles passing through the road.

Before leaving the machine, fully lower the bucket down to the ground, lock up joystick with locking device, shut down the engine, and pull up the parking brake switch to the "brake" position. Lock all equipments with keys, and remove and carry the keys.

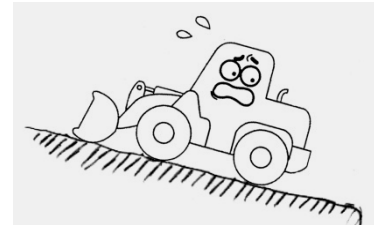

### 1.6.6 PRECAUTIONS WHEN LOADING THE MACHINE

When loading or unloading machine, the engine should be ran at low speed, while the machine should walk at low speed.

Loading or unloading of the machine should progress on solid and even ground, and keep a safe distance from the roadside.

Fix the carrying truck when loading or unloading the machine, and place a pad block under the springboard.

Use inclined plates with enough strength, width and length to provide a safe loading or unloading slope. The oblique angle between slant plate and ground shall not exceed 15°. The distance between the slant plates shall be compatible with machine's wheelbase

Firmly fix the position of slant plate, and make sure they have the same height.

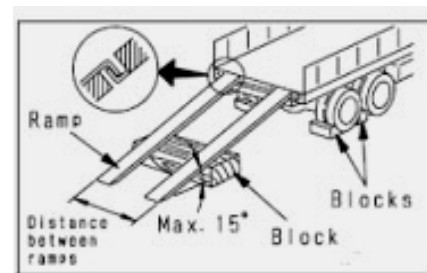

Make sure the surface of the slant plate is clean, no lubricants, grease, ice and loose materials. Clear the tires.

Do not turn direction on the slant plate. If necessary, let the machine leave the slant plate, and then adjust the wanted direction before turning.

After loading materials, wedge the machine tires and tighten the machine with cord.

### **1.6.7 PRECAUTIONS OF MACHINE TRANSPORTATION**

When carrying this machine with trailer, it is necessary to comply with national and local laws and regulations for the weight, height, and length of heavy objects and comply with all relevant traffic laws and regulations.

Take machine's weight, height, width and length into account when determining transportation route.



Check whether its loading capacity can support the weight of the machine when passing through a bridge or a structure.

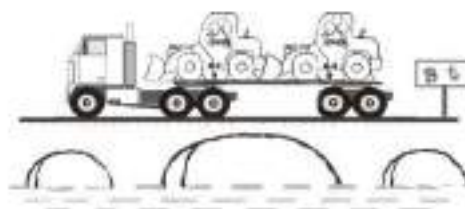

When the machine travels on the public road, first check whether it is in comply with the provisions of relevant authorities and follow those provisions.

The machine may need to divide into several parts for the convenience of transport. For the division of this machine, please consult the designated dealer of LONKING Holdings Limited.

### **1.6.8 PRECAUTIONS FOR DRAG**

If the machine dragged with incorrect ways or wrong steel wires, it may cause injuries or casualties; therefore, it is important to abide by the follow precautions:

Wear protective leather gloves when touch the steel wires.



Agree on a common signal before dragging the machine together with other workers.

If there are some problems such as failing to start the machine or braking system, please contact the designated dealer of LONKING Holdings Limited for repair.

It is dangerous to drag the machine on the slope, therefore it is right to choose a flat gradient place, if this place is not available, choose a place as small angel as possible to drag the machine.

If another machine drags the failed machine, the strength capacity of the used steel wire must bear the weight of failed machine.

Make sure that the steel wire is no cutting trace, twist or shrunken diameter.

Do not divide your two feet and stride over the steel cable or rope.

Make sure there is nobody stands between the dragging machine and failed machine.

Make sure the dragging machine and failed machine are in the same straight line and in place.

### **1.6.9 PRECAUTION FOR USE AND MAINTENANCE OF THE BATTERY**

Because the battery electrolyte contains sulfuric acid and can produce hydrogen gas, incorrect process may cause serious injury or fire. Therefore, please strictly abide by the following precautions.

It is not allowable to put lit cigarette or open fire close to the battery.

Wear safety glasses and rubber gloves when it is necessary to contact with battery.

If the electrolyte of battery splashed on your clothes or skin, immediately rinse with plenty of clean water.

If the electrolyte of battery splashed into your eyes, it may cause blindness. Therefore if it happens, immediately rinse your eyes with plenty of clean water, and see a doctor at once.

If accidentally drink the electrolyte, you must drink plenty of water or milk, raw eggs or rape oil, at the sa



me time call the emergency center for help.

Please shut down the engine before operating the battery. Avoid metal objects (such as tools) unexpected contact with the battery, because it may cause short-circuit between the positive (+) and negative (-) terminal.



When installing battery, first connect positive (+) terminal, while demounting battery, first disconnect negative (-) terminal (ground side).

When amounting or demounting battery, first identify which is positive (+) terminal and which is negative (-) terminal, and tighten the nuts firmly.

Clean the top surface of battery with wet cloth instead of gasoline, solvent, or any other organic solvent and cleanser.

Tighten the top cover of the battery.

If the electrolyte of battery has frozen, it is dangerous to charge the battery or start the engine with other power supply, for is may cause battery fire.

Unfreeze the electrolyte and check whether there is leakage before charging the battery or starting the engine with other power supply.

Demount battery from the machine before charge it.

### **1.6.10 PRECATUTION FOR START-UP WITH BOOSTER CABLE**

If the connection method of booster cable is wrong, it may cause fire; therefore, it is necessary to abide by the following methods:

It requires two operators to start the machine (one of them sitting down the operator's seat)

It is not allowable the two machines contact each other when starting another machine.

When connecting the booster cable, turn off the two starter switches of normal machine and failed machine.

When installing the booster cable, first connect the positive (+) pole cable, while demounting the booster cable, first disconnect negative (-) pole cable (ground side).

The final earth connection means connect the earth cable to the engine of failed machine, but it will produce sparks, therefore, make it keep away from the battery.

When demounting the booster cable, do not let the clips of booster cable touch each other

or touch the machine.

### **1.6.11 PRECAUTIONS FOR BATTERY CHARGE**

If use the wrong method to charge the battery, it may cause battery explosion. Therefore, it is important to abide by the related charge regulations and instructions stipulated in the manual and note the following tips.

Choose a well-ventilated place to charge the battery. Remove the battery cap to release hydrogen gas and prevent explosion.

Set the charger voltage value to be consistent with battery voltage value. If the voltage is wrongly set, it may cause charger overheating or fire and explosion.

Connect the charger's positive (+) clip to positive (+) terminal of battery, correspondingly, connect negative (-) clip to negative (-).

IF the charge rate of the battery is less than 1/10, give high-speed charging and set the values into the rated capacity of the battery. If the charge current is too large, it may cause electrolyte leakage or evaporation, which may catch fire or cause explosion.

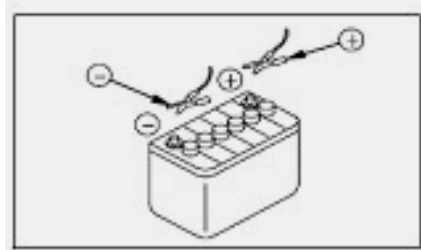
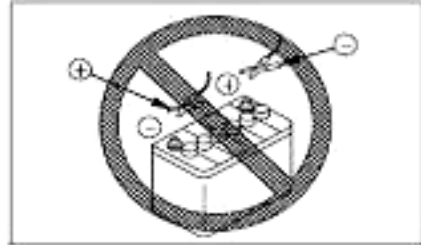

## **1.7 MAINTENANCE PRECAUTIONS**

### **1.7.1 FAULT NOTIFICATION**

If processing maintenance has not mentioned in Operation Manual, it can lead to unexpected fault. Then please contact to designated dealer of LONKING Holdings Limited for repair.

### **1.7.2 CLEANING BEFORE REPAIR AND MAINTENANCE**

It needs to clean up the machine before repair and maintenance. This ensures that no waste enters into the machine, as well as the smooth and safe process of maintenance



When performing cleaning, pay attention to the following items:

1. Wear non-slip shoes to prevent falling down from the wet or oil surface.
2. When using high-pressure water to wash machine, please wear protective clothing to avoid the impact of the high-pressure water, such as hurting the skin or wastes, mud splashed into the eyes.
3. Prohibit water spray onto components of the electrical system (like sensor, wiring plug connector), in case that water goes into electrical system that causes malfunctioning.

### **1.7.3 KEEP CLEANNESS OF WORKPLACE**

Do not leave any maintenance tool around in the workplace. Please wipe out all the grease, lubricants, or other things that may make people slip completely.

Do keep the workplace clean and tidy in order to work safely and avoid danger of tripping, slipping, falling and alike, resulting in injuries.

### **1.7.4 DESIGNATION OF RESPONSIBLE PERSON**

During repair of machinery, loading and unloading equipments, or cooperation with others, one principal should appoint whose order the others should obey, which will avoid misunderstanding that resulting in serious accidents.

### **1.7.5 CHECKING WATER LEVEL OF RADIATOR**

When checking water level in radiator, be sure to stop engine, wait until the cool down of engine and radiator before checking water level check in the water tank.

If you need to open the radiator cap, comply with the following methods:

- Check water temperature before the compressor down.
- When the filler cap is cool enough to be open by bare hand, loose the radiator filler cap to release its inner pressure and then open the top cap.

## 1.8 OPERATING BEFORE REPAIR AND MAINTENANCE

Before repair and maintenance, park the machine on the level ground where there is no falling stones or landslides. If parking in a lower position, there should be no danger of suffering flood, and then shut down the engine.

After stopping the engine, shift the joystick of working device to UP and DOWN positions several times in order to release the left pressure within the hydraulic oil circuit. Then lower the working device to the ground, and lock up the joystick with locking kit.

Pull up the parking brake switch, perform braking and put wedge down the tire.

Lock up the front and rear frames with the frame fixing rod. During maintenance, be careful not to be touched or to be hooked by moving parts.



### 1.8.1 SUPPORT OF WORKING DEVICE

Be sure to lock safety support up to the piston rod of the lift arm cylinder to restrict the retraction of lift arm cylinder, to prevent the falling down of working device. In addition, shift the joystick to neutral position; lock up the joystick with lock kit.

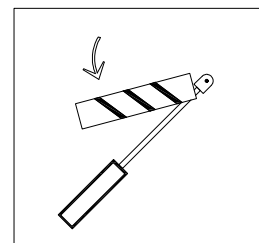

### 1.8.2 APPROPRIATE TOOLS

Be sure to use appropriate tools designated to the task. Using damaged, inferior, defective or temporary tool can lead to personal injury.

### **1.8.3 REGULAR REPLACEMENT OF CRITICAL SAFETY PARTS**

Fuel, tubes of hydraulic system and braking system and other parts is critical to ensure safety, be sure to replace them regularly.

Certain technology is necessary to replace the critical safety parts. Please contact the dealer of LONKING Holdings Limited to do so.

Critical safety parts will go aging with time and oil leakage will lead to serious accident; during their use, if any problem is discovered, they shall be replaced or repaired in time, even if the specified interval is not reached; no matter whether critical safety parts have any failure, these parts shall be replaced at regular intervals with new ones.

Regular replacement of critical safety parts is shown in **Catalog and Replacement Cycle of Critical Safety Parts**.

### **1.8.4 ILLUMINATION**

When checking fuel, lubricant, battery electrolyte, or window glass detergent, make use of explosion-proof lighting equipment to avoid risk of explosion.

If work in the dark without lighting, there would be the risk of injury, so to install the appropriate lighting equipment.

Even in the darkness, it is not allowed to use lighters or open flame to illuminate. This has the danger of catching fire, for gas from the battery may produce an explosion.

When using the machine as a lighting source, be sure to comply with the guidance of **Operation Manual**.

### **1.8.5 FIRE PREVENTION**

Gas from fuel and battery may be ignited during maintenance, so it is necessary to comply with the following precautions during maintenance or repair:



Fuel, lubricant and the other inflammable should be stored far away from open fire.

Do not use diesel or gasoline, for it has risk of lighting; use incombustible material as detergent for cleaning the parts.

Smoke at the designated place. Smoking is prohibited when overhaul or maintenance is performed.

Use explosion-proof feature of the lighting equipment to check fuel, lubricating oil, or battery electrolyte, Prohibit use lighters or matches to light.

When do grinding or welding operation on the frame, move all the flammables to a safe place.

There should have a fire extinguisher in repair and maintenance work site.



### **1.8.6 PERSONS FOR REPAIR AND MAINTENANCE**

Only personnel with relevant qualifications can repair or maintain this machine. Personnel unrelated with work of repair and maintenance is not allowed to enter working site. If necessary, designate a person keep guard.

Pay special caution to keep your personal safety during grinding, welding or using of a sledge-hammer and other operations.

### **1.8.7 ATTACHMENTS**

Designate a person in charge when demounting or mounting a component.

It is not allowed for any non-staff to close to the machine or components.

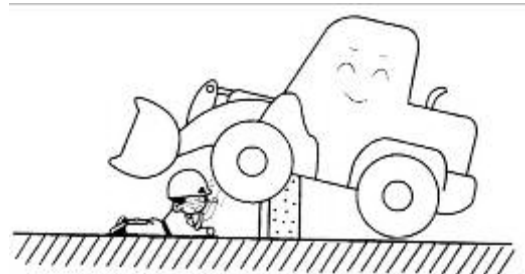

Put the demounted components into a safe place and make sure they would not fall. Encircle the demounted components with a fence and put up a sign of “no entry” to avoid prohibitive person entering this area.

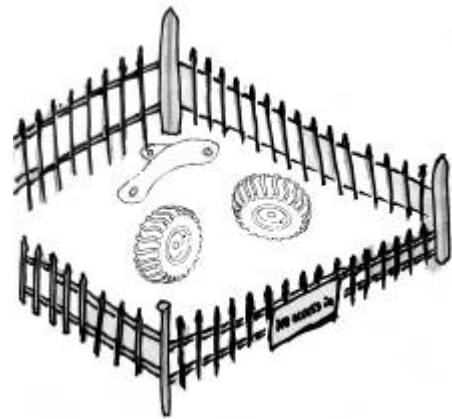

### **1.8.8 MAINTENANCE UNDER MACHINE**

Before maintenance or repair, stop the machine on a solid flat ground, lower the working device to the ground and fix the tires with wedges;

Working under the poorly supported machine is prohibited. If the tires are off the ground and the machine is only supported by the working device, maintenance under the machine is very dangerous.

### **1.8.9 MAINTENANCE WITH THE FRAME SUPPORTED UP**

When the frames are maintained with the working device lifted, it is necessary to lock up the front and rear frames with the frame fixing rods. Set the joystick to the “neutral” position, lock up joystick with locking equipment, and then support the working device with supporting rods.

Before lifting, wedge the wheel from the opposite side. After lifting, place a block under machine

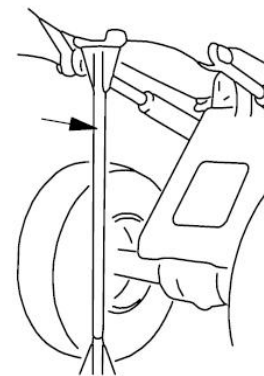

### **1.8.10 MAINTENANCE ON THE TOP OF THE MACHINE**

When conducting maintenance on the top of the machine, make sure your standing point is clean and no barrier, as well as comply with the following items for the prevention of falling:

Spilled lubricant or grease is not allowable.

No tools or spare parts displayed around.

Pay attention to your walking steps

Prohibit jumping from the machine. Be sure to use ladder and handrail when up and down the machine, and always maintain a three-point contact (two-foot one-hand or two-hand one foot).

If necessary, use protective equipment.

Top of the engine hood and top of tire are smooth and dangerous; and it is prohibited to stand on them.



### 1.8.11 MAINTENANCE WHEN ENGINE IS WORKING

To avoid hurting, do not conduct maintenance when the engine is running.

Be sure to comply with the following items for maintenance when the engine is running:

To arrange one worker sitting in the operator seat, and ready to shut down the engine at any necessary moment. All workers must keep contact with others.

When the operating point close to the rotating components, extra care should be taken for there is the danger of being involved by rotating parts.

Avoid any tools or any part of the body touching the fan blades or fan belts.

When clearing the inner of radiator, it is necessary to lock up joystick with lock equipment to prevent movement of working device. In addition, pull up the parking brake switch to implement braking.



Do not touch any joystick. If it is indispensable to operate joystick, you must notify other workers to walk away to safe place.

### **1.8.12 NO LEAVING OF FOREIGN MATTER INSIDE MACHINE**

When opening the repair windows or refueling port of fuel for repair, pay caution not to let any foreign objects drop (such as nuts, bolts, cotton, or tools) into the hood. If there is thing falling within the machine, it will cause damage to the machine, operational failures and other faults.

If there is any foreign object falling into the machine, make sure to remove it from the inside of the machine.

During maintenance, do not carry any unnecessary tools and spare parts in the pockets.

### **1.8.13 PRECAUTIONS IN THE USE OF HAMMER**

When using a hammer, be sure to wear safety glasses, safety helmets and other protective clothing, and place a brass rod between the hammer and area being hammered.

When hammering hard parts, such as a pin or a bearing, there will be the injury risk of debris flying into the eye.



### **1.8.14 WELDING REPAIR**

Welding operation should be performed by qualified welders, and conduct in place fitted with appropriate equipment. Welding will produce gas, so there is hazard of causing fire and electric shock when doing welding. Therefore welding must comply with the following notes:

- Disconnect the connection of the battery terminals to prevent battery explosions.
- Clear the paint of welding parts to prevent harmful gases.
- When welding on the hydraulic device or pipe, or near them, it will produce combustible vapors and sparks



that have risk of ignition. Thus, it is necessary to avoid welding in such a place.

- If the welding sparks flying directly onto rubber hoses, wires or pipes with pressure, these tubes may suddenly rupture and wire insulation skin may be damaged, so it is necessary to cover these things with fire flapper.
- Wear protective clothing during welding operation.
- Keep the welding work site well ventilated.
- Clean all flammable materials before welding, and equip with fire extinguishers on the working site.

### **1.8.15 PRECAUTIONS FOR BATTERY MAINTENANCE**

The negative pole (-) of the battery must be disconnected when the electrical system is repaired or electric welding operation is performed on the machine, so as to prevent current flow.

### **1.8.16 TREATMENT OF ABNORMAL STATUS**

If any abnormal status is found during overhaul, repair it. Especially that when the machine is in operation, there is any irregularity in braking system, steering system or working device system, which can lead to serious accidents.

Please consult the designated dealer of LONKING Holdings Limited for repair according to the fault types.

### **1.8.17 FILL OF FUEL OR LUBRICATING OIL**

Fuel, lubricating oil, hydraulic oil, antifreeze, brake fluid, window glass detergent can be ignited by flame. Therefore please comply with the following provisions:

When filling fuel or lubricating oil, close engine

No smoking.

Overflowed fuel, lubricating oil, hydraulic oil, antifreeze, and brake fluid or window glass detergent should be cleaned up immediately.

All top caps of container of the fuel, lubricating oil, hydraulic oil, antifreeze, braking fluid and window glass detergent should be tightened firmly.

Place of filling or storing of fuel, lubricating oil, hydraulic oil, antifreeze, brake fluid or window glass detergent should be well-ventilate.

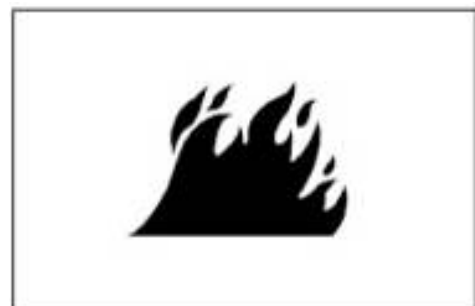

### **1.8.18 HANDLING OF HIGH-PRESSURE HOSE**

If the high-pressure hose leaks, it may lead to malfunction, personal injury or equipment damage. If find that the hose is damaged or bolts loose, stop working, and contact with the designated dealer of LONKING Holdings Limited for repair.

Replacement of high-pressure hose needs superb skills. Installation torque should be determined by the type and size of hose. So this work should not be done by the user, please contact the designated dealer of LONKING Holdings Limited for replacement.

### **1.8.19 PRECAUTIONS OF HIGH-PRESSURE OIL**

When repair or replace line in hydraulic system, it is needed to make sure that system pressure has been released. If there is pressure left in the line, this may lead to serious injury or damage, therefore, please comply with the following measures:

- Never perform any repair or replacement ahead of the complete release of the pressure.
- Wear safety glasses and leather gloves.
- If the line leaks, then the line and its surrounding will be wet, it's time to check whether there is crack in the steel pipe or in the hose, or there is blister in the hose. If the leaking place is difficult to identify, please contact with the designated dealer of LONKING Holdings Limited about repair issues.
- Do not use bare hands to check for leakage, but to use the board or cardboard to check for leakage.
- If shot by the sprayed high-pressure oil, be sure to contact the doctor for treatment immediately.

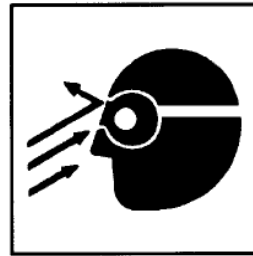

### **1.8.20 PREVENTION MEASURES OF MAINTENANCE IN HIGH TEMPERATURE OR HIGH PRESSURE**

When the machine just stops working, cooling water and oil of all parts of engine is in high

temperature and high pressure. If now open the engine hood to do drain of oil, water or to replace filter, this may lead to burn or other injuries. It is needed to wait for the temperature drop, and then conduct repair according to requirements in the Operation Manual.

### 1.8.21 WASTE DISPOSAL

In order to prevent pollution, especially in place lived with people or animals, must comply with the following requirements:

- Prohibit waste oil to dump into drainages and rivers and other places.
- Discharged oil from the machine should be placed in containers, do not discharge the oil directly onto the ground.
- When dealing with hazardous substances such as lubricants, fuel, coolant, solvents, filters, batteries and other substances, it is necessary to comply with relevant laws and regulations.



### 1.8.22 PRECAUTIONS OF TIRE MAINTENANCE

Tire filled with gas explodes for the inner gas is overheated, commonly due to heat from welding or wheels rim, external fire or brake too often. Tire explosion is so powerful which can cause tire, wheel rim, and eventually transmission parts flying 500 meters away from the machine. Explosive force and fragments of the explosion can lead to casualties and property damage.



Equipments and staff are needed to avoid over-inflation. Leakage or rim damage is due to the incorrect or improper use of inflatable equipment. When inflating tire, you should stand on the side and use automatic working clamp.

**Danger may exist during maintenance and replacement of tire or wheel rim, as a result it requires trained personnel to operate strictly according to operation specifications provided by maintenance personnel of tire or wheel rim or the dealer.**

If the operation of the tire or wheel rim goes wrong, tires may burst or rupture, wheel rim may be damaged and spread around, may result in serious injury or death.

In order to ensure the security of maintenance work, the following precautions should be

complied with:

- Maintenance, demolition, repairs and installation of tire and rim requires special equipment and expertise, so it is necessary to have it done in the tire repair shop.
- Use only the specified tires, charge to the required pressure.



- During tire inflation, other unrelated persons are not allowed to enter the work area.
- Stand by the side of the tire and use automatic working clamp, check the inflation pressure occasionally so that it will not be too high.
- If the rim is not installed correctly, when the tire inflated, the wheel rim may be damaged or spread about. Therefore, it is necessary to place shield around the tire, and do not work in the front of the rim but beside the tire.
- When the abnormal decline in tire pressure or irregular match of the rim and the tire, which indicate there is problem in tire or wheel rim. In this case, it is necessary to seek help from the tire repair shop.
- After high-speed driving or heavy-load operation, do not adjust inflation pressure.
- Tire filled with gas can explode because of heat and robust to the inner gas of the tire. This heat always comes from warm-up or welding to the wheel rim, external flame, or brake too often, which cause inflation or robust of gas suffered from heating.
- Tire explosion is much powerful than disinflation that can cause tire, wheel rim, and eventually transmission parts flying 500 meters away from the machine. Explosive force and fragments of the explosion can lead to casualties and property damage.
- Recommend to fill the tire with nitrogen. If the tire is filled with air, it is recommended to use nitrogen to adjust gas pressure, and nitrogen can mix with atmospheric gas. Tire filled with nitrogen will decrease the possibility of explosion, for nitrogen is incombustible, besides this, nitrogen can prevent the oxidation and aging of rubber and corrosion of wheel rim parts.



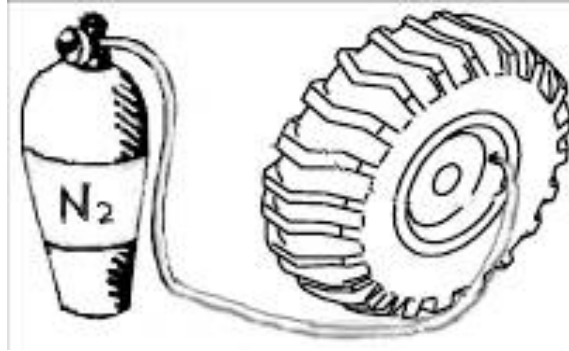

- Equipments and staff are needed to avoid over-inflation. Leakage or rim damage is due to the incorrect or improper use of inflatable equipment.

### 1.8.23 PRECAUTIONS OF TIRE STORAGE

Tires should be stored in warehouses, and unauthorized personnel are not allowed of entering. If the tires are stored outdoors, there should be fence erected around the tires.

If the tire is put onto ground with its side, it will be squeezed, and its quality declines.

If the tire is falling down, it is better to run away, for the tires of engineering machinery are extremely heavy, therefore, any attempts to stop its falling may lead to serious injury.

Erect the tires on level ground, fixed with wedge, even if touched by unauthorized personal, they cannot fall down.

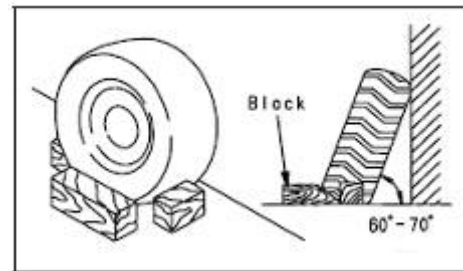

## 1.9 CATALOG AND REPLACEMENT CYCLE OF CRITICAL SAFETY PARTS

To ensure the security of loader in operation, the user has to insist on regular maintenance. In addition, in order to enhance security, the user has to replace parts regularly based on the following table. The material of these parts will deteriorate as time goes by, or tend to be worn and eroded easily. It is difficult to judge the condition of the parts only through regular maintenance, as a result, no matter what conditions they are in, these parts should be replaced regularly, to ensure their working performance.

If working time of the parts is less than replacement cycle, but finding abnormality in their working, it is necessary to have a replacement or repair immediately.

If pipe clamp used to fix the tube has any damage, such as distortion or crack, it should be

changed with the tube.

When replacing tube, be sure to replace O-ring, gasket and parts like this at the same time.

Please contact designated dealer of LONKING Holdings Limited to replace critical safety parts.

**REGULAR REPLACEMENT TABLE OF CRITICAL SAFETY PARTS**

No.	Critical parts needed regular replacement	Quantity	Replacement cycle
1	Filter element of hydraulic oil tank	2	Each year or 2000 hours (whichever is earlier)
2	Rubber hose from fuel tank to primary fuel filter	1	Every two years or 4000 hours (whichever is earlier)
3	Primary fuel filter to engine's oil inlet rubber hose.	1	
4	Rubber hose from diesel engine's oil return port to fuel tank	1	
5	Fuel Hose (Transfer pump-Fuel filter)	1	
6	Fuel hose ( Fuel filter-Fuel injection pump)	1	
7	Return oil hose of Turbocharger	1	
8	Inlet oil hose of priority valve	1	
9	Bypass hose of priority valve	1	
10	Rubber hose from steering pump to priority valve	1	
11	Rubber hose from steering pump to steering cylinder	2	
12	Rubber hose between steering cylinders	2	
13	Rubber hose from distribution valve bucket steel tube to bucket cylinder	2	
14	Rubber hose from working pump to distribution valve	1	
15	Rubber hose of lift arm cylinder	4	

## CHAPTER II OPERATION AND CONTROL

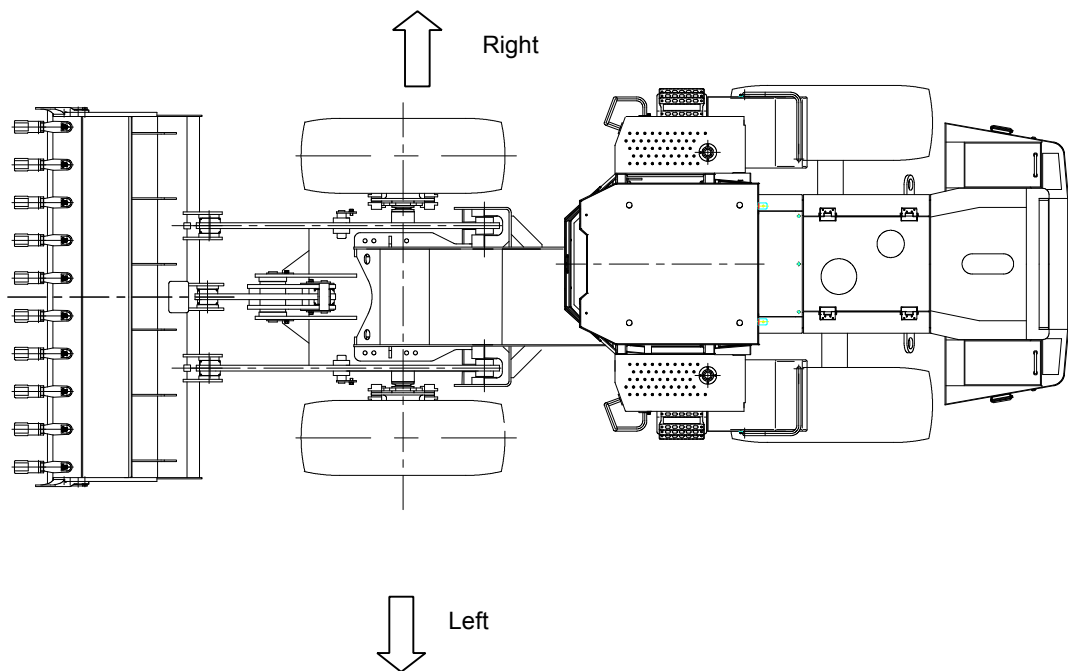
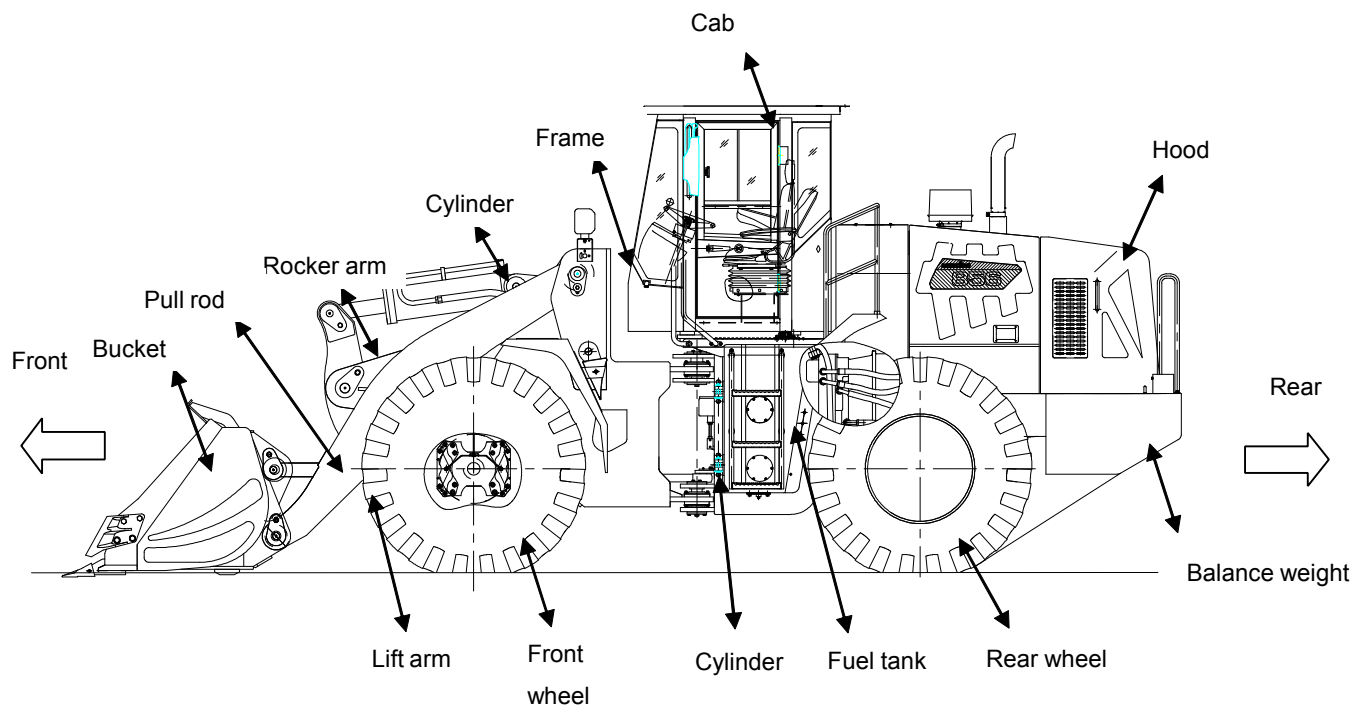

**Components and Schematic Diagram of Wheel Loader**

## 2.1 MAIN PERFORMANCE PARAMETERS AND SPECIFICATION

ITEM		CDM853	
Performance	Bucket capacity (m <sup>3</sup> )	3.0	
	Rated payload (Kg)	5000	
	Lifting time(s)	≤6.0	
	Falling time (s)	≤4.0	
	Total hydraulic cycle time (s)	≤11	
	Maximum speeds (km/h)	Forward I (km/h)	11.5
		Reverse I (km/h)	16
		Forward II (km/h)	36
		Reverse II (km/h)	-
		Forward III (km/h)	-
		Reverse III (km/h)	-
		Forward IV (km/h)	-
	Traction force (kN)	155±3	
	Maximum breakout force(kN)	≥155±5	
	Maximum Grade ability ( ° )	28	
	Minimum turning radius	Measured at centerline of outside tire (mm)	5885mm
		Measured at outer side of bucket (mm)	6805mm
	Dimensions(mm)	Loader length (with bucket flat on ground) (mm)	7760±100mm
		Loader width (from wheel outside) (mm)	2835±50mm
		Bucket width (mm)	3000±30mm
		Loader height (from cab top)(mm)	3380±30mm
		Wheel base (mm)	2930±30mm
		Wheel track (mm)	2240±10mm
Minimum ground clearance (from articulating point)		400±20mm	
Max. lifting height (mm)		3078±50mm	
Unloading distance at max. lifting (mm)		1190±50mm	
Loader weight (Kg)	15800±300kg		
Driver's seat	In the cabin		

ITEM		CDM853	
Engine	Model	WD10G220E21	
	Rated speed (r/min)	2200	
	Maximum torque (N·m /r/min)	860/1400-1600	
	Specific fuel consumption in rated operating mode (bench test) (g/kw·h)	225	
	Fuel type (according to ambient temperature)	0# diesel oil	
	Fan diameter (mm)	φ780	
Drive System	Hydraulic torque converter	Type	Single-stage, dual-turbine, four elements
		Conversion ratio	4.0
		Cooling system	Air cooled pressure circulation
	Gearbox	Type	Planetary power shift, constant mesh all spur gear
		Number of speeds	Mechanical gear shift, two forward gears, one reverse gear
		Transmission oil pump	Gear pump
		Working pressure (MPa)	1.2~1.5
	Main drive and wheel-side reducer	Main drive type	Single stage reduction, spiral bevel gear
		Hub reduction type	Spur gear planetary drive
		Speed reduction ratio	23.276
		Main drive reduction ratio	5.286
		Hub reduction ratio	4.4
	Drive axle and wheel	Type	Four-wheel drive
		Tire	23.5-25 L-3 16PR TT
		Tire pressure (MPa)	Front wheel 0.32±0.01 Rear wheel 0.28±0.01
Brake system	Service brake	Type of braking	Air over oil caliper disc four-wheel braking
		Braking air pressure (Mpa)	0.78
	Parking and emergency brakes	Type of braking	Flexible shaft controlled caliper disc brake

ITEM		CDM853	
Steering System	Type	Fully hydraulic load-sensitive	
	Number of steering cylinders—inner diameter × stroke (mm)	2-φ90X324mm	
	Steering pump	Gear pump with constant displacement	
	System working pressure (MPa)	15	
	Steering angle (°)	Left/ right 35	
Working mechanism	Number of boom cylinders – inner diameter × stroke (mm)	2-φ160×836mm	
	Number of bucket cylinders – inner diameter × stroke(mm)	1-φ180×559mm	
	Distribution valve	Hydraulically-controlled, multi-way valve	
	Model number	D32.2	
	Displacement of working pump (ml/r)	220/2200	
	System working pressure (MPa)	16	
	Working device	Single-rocking-arm, reverse six-link mechanism	
Electrical system	System voltage (V)	24	
	Battery capacity (Ah)	2-N120	
	Lamp voltage (V)	24	
	Diesel engine starting	24V electric starting	
Filling capacity	Total volume of hydraulic oil tank and fuel tank	285L	
	Hydraulic oil filling amount	270L	
	Engine oil filling amount	20L	
	Oil filling amount of gearbox	45L	
	Total oil filling amount of front & axle drive axles	28L/28L	
Air conditioning system	Warm air	Operating medium	Diesel coolant
		Heating power	5000W±10%
	Cool air	Operating medium	R134a
		Refrigerating power	4200W±10%
	System voltage (V)		24

Note:

1. Technical parameters involved in this instruction book are not inspection or test bases. Those parameters may be changed without notice.
2. The foregoing oil filling standards are for reference only. Oil replenishment is performed depending on actual liquid level of oil inspected.

## 2.2 OUTLINE DRAWING OF WHEEL LOADER

### 2.2.1 CDM853

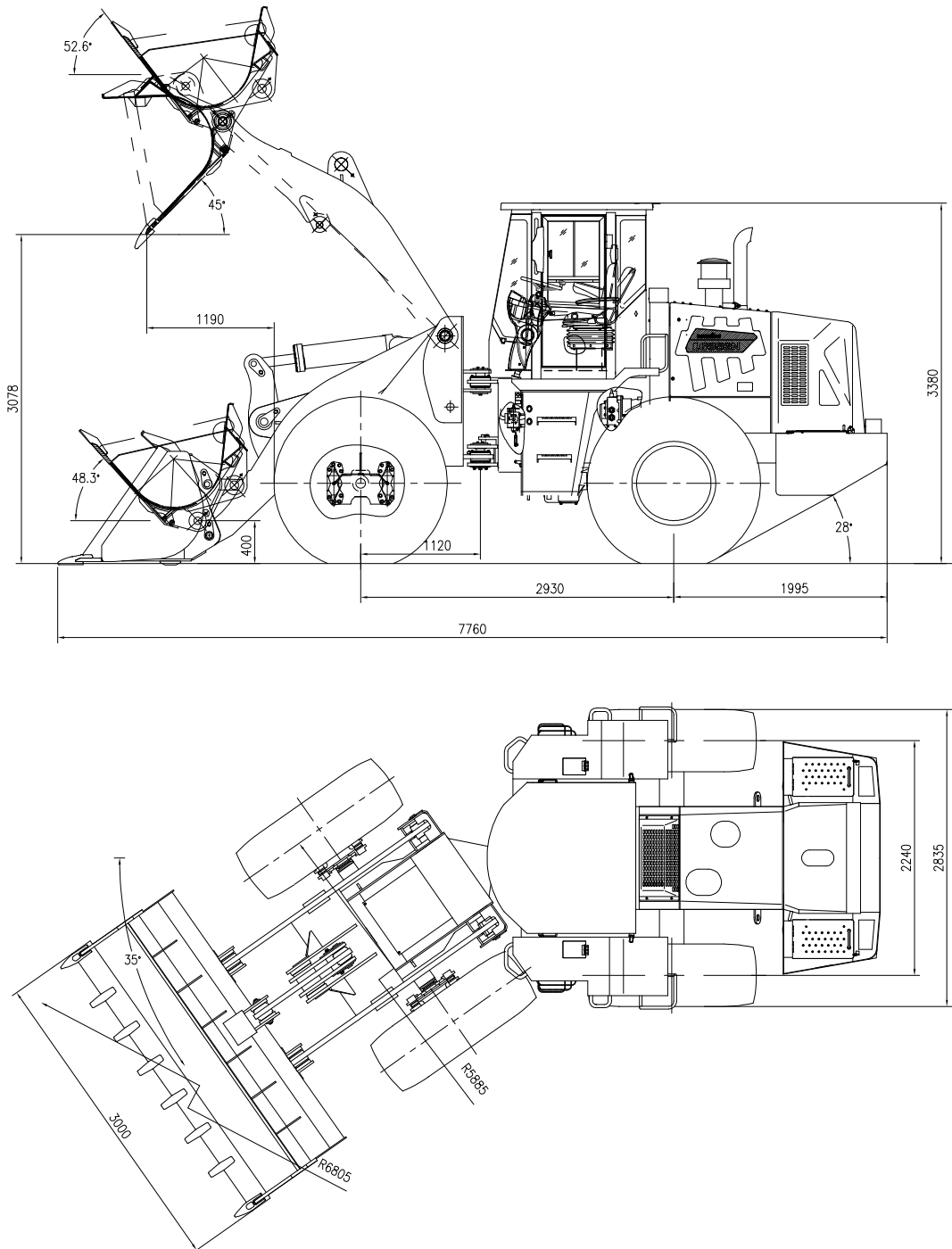





## 2.3 PURPOSE

CDM853 articulated wheel loader is a medium- and small-sized, efficient and multi-functional earthmoving machine and mainly used for handling bulk materials. The loader is widely used for loading, bulldozing, shoveling, traction, lifting and transportation in mines, civil works, road constructions, harbors and goods yards.

The loader can be customized to include new functional devices, such as high dumping bucket, extra-large coal bucket, side-dumping bucket, and wood-handling fork.

In the case of a standard bucket, the specific weight of bulk materials should be 1.5~1.8g/cm<sup>3</sup>; in the case of a high dumping bucket or extra-large coal bucket, the specific weight of bulk materials should be equal to or less than 1.2g/cm<sup>3</sup>; in the case of a high dumping bucket and extra-large coal bucket, the specific weight of bulk materials should be equal to or less than 1.0g/cm<sup>3</sup>.

It is not recommended to use the loader long time for bulldozing or traction, otherwise the temperatures of water, torque converter and transmission oil may rise sharply.

The loader is a general-purpose engineering machine. Do not use the loader in environment with flammable material, explosive material, dense dust, or toxic gas.

## CHAPTER III OPERATION INSTRUCTIONS

### 3.1 STEERING WHEEL

The articulated loader uses fully hydraulic power steering. The steering wheel is arranged inside the Cab and connected to the full-hydraulic redirector. Turning clockwise the steering wheel turns the loader right; turning counterclockwise the steering wheel turns the loader left.

The fully hydraulic power steering has the following features:

1. The turning angle of steering wheel is not equal to that of the loader. Continuously turning the steering wheel can increase the turning angle of loader to the expected value.
2. The faster the steering wheel is turned, the faster the loader is turned.
3. The steering wheel cannot automatically return to its original position, thus the turning angle of loader remains unchanged. Therefore, when the turning of loader is accomplished, it is necessary to turn the steering wheel in the opposite direction, to bring the loader to the straight ahead direction.



### 3.2 NEGATIVE-POLE SWITCH OF BATTERY

The battery negative-pole switch is arranged at the left side inside the rear hood.

The battery negative-pole switch differs from the starter switch. Disconnecting the negative-pole switch will turn off the electrical system of loader. When the starter switch is turned off, some electrical parts of loader may still be working because the battery is still connected with loader's electrical system.

#### **To turn off the battery negative-pole switch :**

To disconnect the power supply to the electrical system of loader, turn the battery negative-pole s



witch handle counterclockwise to “OFF” position.

#### **To turn on battery negative pole switch:**

Before starting the loader, it is necessary to turn the negative-pole switch handle clockwise to “ON” position.

#### **Warning**

**Do not turn off the battery negative-pole switch while the engine is in operation, otherwise the electrical system of loader may be damaged.**

### **3.3 STARTER SWITCH**

The starter switch (“electrical lock”) is arranged on the panel of control box in the right of Cab. The starter switch can be turned clockwise to three positions.



1. **OFF**-- When the starter switch key stays at this position, the power supply to loader will be cut off. The loader is off, i.e. automatic stop.

#### **Warning**

**Only at this position can the starter switch key be inserted or taken out!**

2. **ON**--clockwise turn the starter switch key, the first position is “ON”. Keep the key at this position, the electrical system of loader is energized.

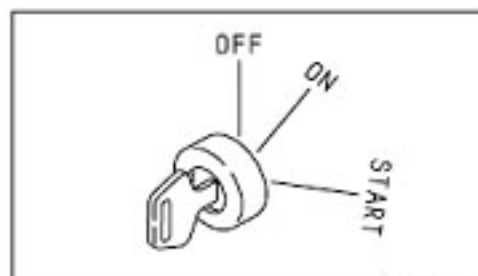

3. **START**--Insert and clockwise turn the starter switch, the second position is "START". With the key at "START" position, the motor is energized to start the engine. Immediately release the key after the engine has been started, the key will automatically return to "ON" position.

**Warning**

**Before starting the engine, check that the negative-pole switch of the battery is turned to "ON" position, and the gearshift handle is at the "Neutral" position.**

**Warning**

**If the engine cannot be started successfully, turn the starter switch to "OFF" position, and then start the engine again, and do not just turn the starter switch to "ON" position and then start the engine again. Failure to do so will cause damage to the starter switch! Each time of starting shall not take more than 15 seconds; interval between two times of starting shall be at least 30 seconds; do not continuously start the engine for more than 3 times; if it is necessary to start the engine for more than 3 times, wait until the motor cools down. Failure to do so will shorten the service life of battery and cause damage to the motor.**

### 3.4 SERVICE BRAKE PEDAL

The service brake pedal (foot brake) is arranged on the left front floor of cab. The service brake system of loader is a single-pedal, independent dual-circuit system. To apply brake to front and rear axles, tread the service brake pedal. In this case, the brake lamp will light up. When one circuit fails, the other circuit is not affected so that the machine maintains partial braking ability, thus ensuring safety. The failed circuit shall be repaired in time so as to ensure that the machine has enough braking ability.

To release service brake, take your foot off the pedal.

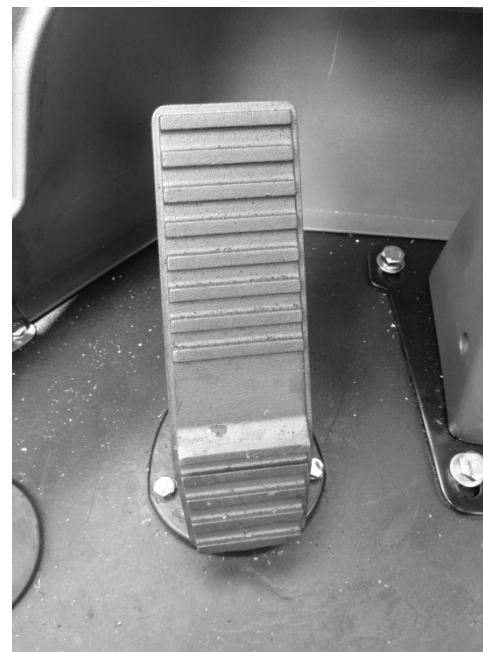

### 3.5 ACCELERATOR PEDAL AND INSTRUMENT PANEL ADJUSTING MECHANISM

The accelerator pedal is arranged on the right front floor of Cab. Not depressing the accelerator pedal, the engine will stay at the idle status. Depressing the accelerator pedal will increase the fuel supply to diesel engine thus the output power of diesel engine.



The instrument desk adjusting mechanism is on the right side of the instrument desk. Generally speaking, the instrument desk tilts backward and forms an included angle of 75° with the pedestal. The adjusting range is 5° forward tilt and 20° backward tilt on this basis.

### **3.6 FLEXIBLE SHAFT CONTROLLED SPEED-SHIFT HANDLE**

The flexible shaft controlled speed-shift handle is arranged below the steering wheel.



Forward/ Reverse;

The flexible shaft controlled speed-shift handle can be turned to 2 forward gears (I, II), 1 reverse gears (I) and 1 neutral gear.

### **3.7 PILOT JOYSTICK**

Pilot joystick is mounted on the right side of seat and used to control the working system.

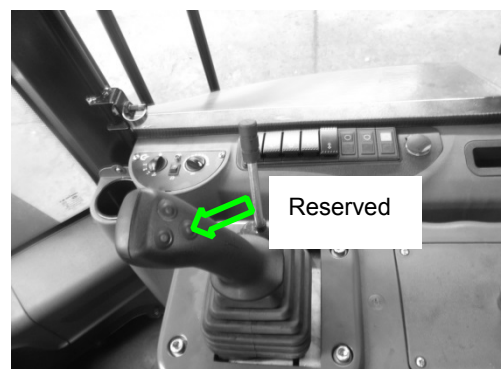

The left and right movements of joystick are used to control the moving direction of the bucket. The

front and rear movements of joystick are used to control the moving direction of the lift arm. Both joysticks are normally in a middle position. When the engine is working, by pushing forwards the pilot joystick, the lift arm will be lowered; by pulling backwards the pilot joystick, the lift arm will be raised; by pushing rightward the pilot joystick, the bucket will dump; by pulling leftward the pilot joystick, the lift arm will roll back. Slightly moving forward or backward the two joysticks can control the opening of main valve. The opening of throttle valve of diesel engine can also be controlled. The two kinds of controlling ensure the exact movement position and speed of working device.

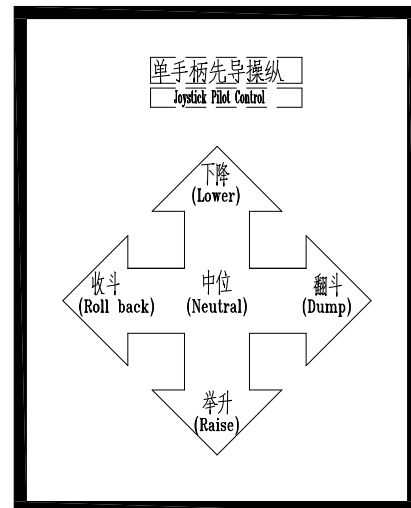

The pilot joystick has the floating function:

By pushing the pilot joystick to the most front position, it will be attracted by the lift arm floating magnet (the lift arm joystick will not return to neutral position even after the operator takes his hand off it), and the lift arm will be brought to the floating status. To terminate the lift arm floating status, pull back the lift arm joystick to the neutral position. To have the bucket scrape materials, push the lift arm joystick to the lift arm floating position, and the bucket will be raised or lowered according to road surface shape but not contact thus protect the road surface.

### 3.8 LAMPS AND THEIR SWITCHES

The lamps of loader include front combination lamps (left, right), front working lamps (left, right), rear working lamps (left, right), rear combination lamps (left, right), in-cab lamp, and alarm lamp.

The front combination lamps include front headlamps, front small lamps, and front steering lamps. The rear combination lamps include rear small lamps, rear steering lamps, brake lamps, and warning lamps.

Front combination lamp

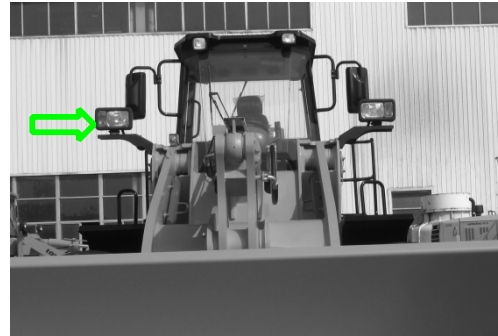

Front working lamp

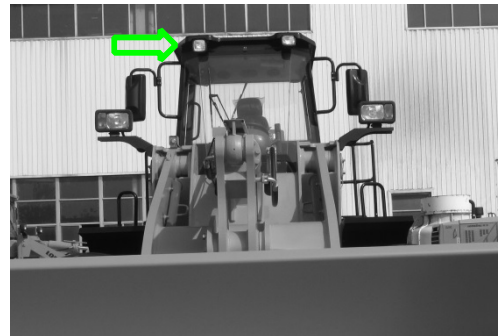

Rear large lamp

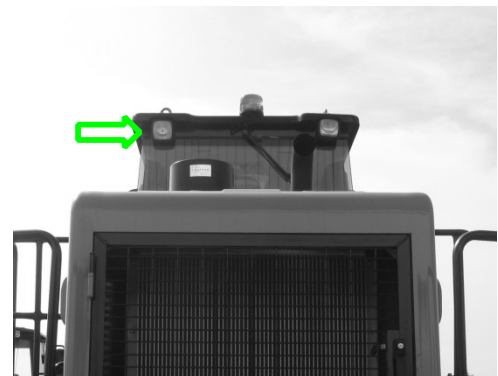

Rear combination lamp

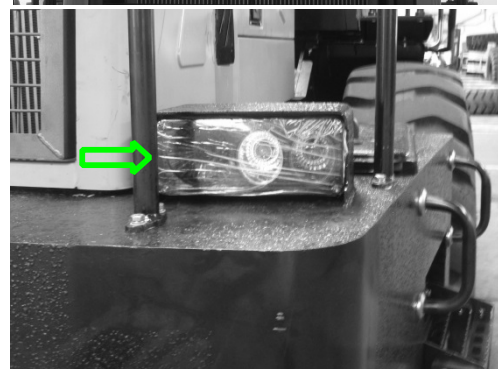



In-cab lamp

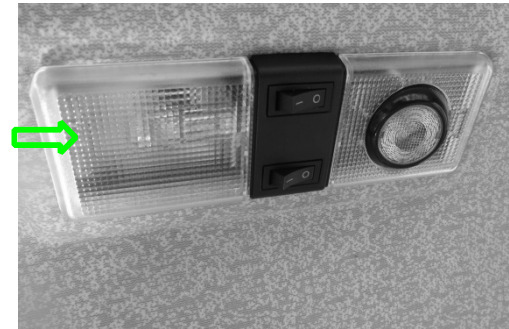

Warning lamp

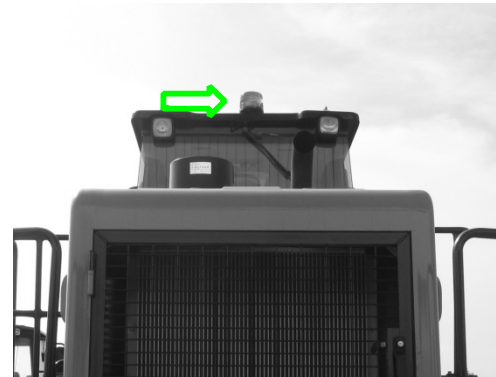

**Rocker switch assembly** (below steering wheel)

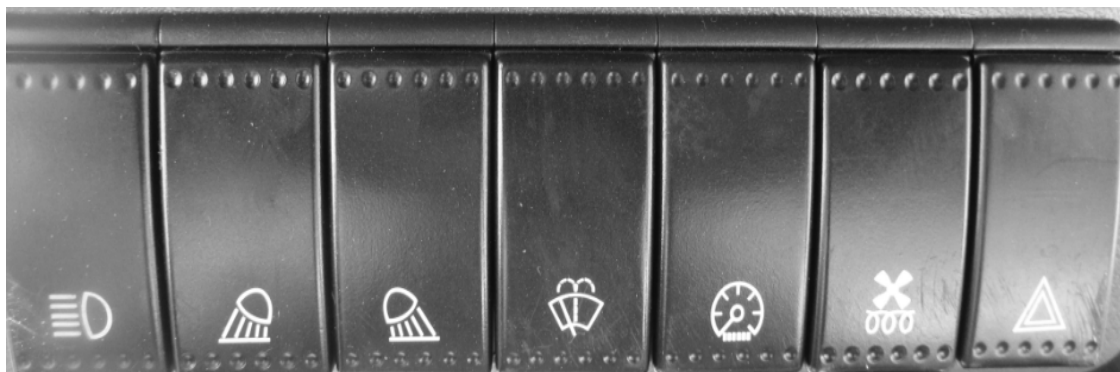

1            2            3            4            5            6            7

1. Combination lamp switch: The combination lamp switch controls the ON and OFF state of the combination lamp.
2. Front working lamp switch: The front working lamp controls the ON and OFF state of the front working lamp.
3. Rear working lamp switch: The rear working lamp switch controls the ON and OFF state of the rear working lamp.
4. Windshield wiper switch: The windshield wiper switch controls the ON and OFF state of the windshield wiper.
5. Instrument lamp switch: The instrument lamp switch controls the ON and OFF state of the instrument lamp.
6. HVAC switch: The HVAC switch controls the ON and OFF state of the HVAC line;
7. Double flash switch: Emergency fault alarm lamp controls the loader through switch. Both left and right turn lamps are lit to remind passengers.

Each rocker switch has a switch indicator lamp. When the combination switch is closed, the switch indicator lamp is lit up; when the combination switch is open, the switch indicator lamp is not lit up.

 **Warning**

**Check if brake lamp, turn lamp or small lamps are damaged or defective before machine operation. In case of any damage or defect, make necessary repair before machine operation!!!**

### 3.9 INSTRUMENT ASSEMBLY AND HORN SWITCH

All monitoring instruments, warning system and steering indicating system of the loader are integrated into the instrument assembly that is below the steering wheel. The instrument system displays many items: engine water temperature, engine oil pressure, engine speed, brake air pressure, fuel amount, transmission oil temperature, system voltage, battery charging indicator, low brake pressure alarm, low transmission oil pressure alarm arm, loader work hour meter, left and right direction signal indicators, cold starter switch, hand brake indicators, high beam indicator.

#### 3.9.1 INSTRUMENT ASSEMBLY

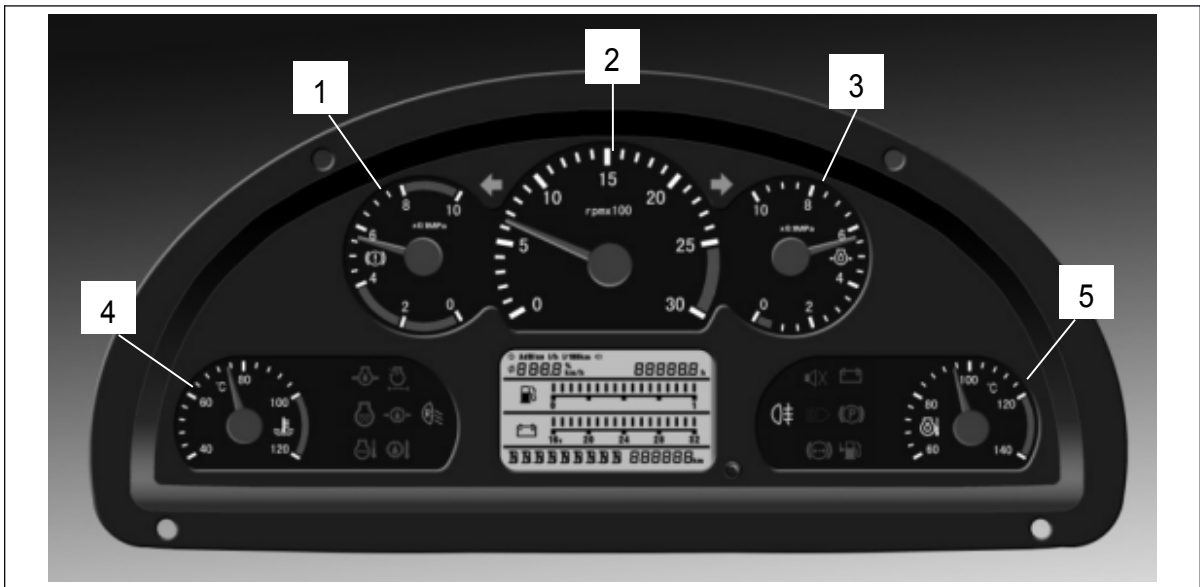

##### 1. Monitoring instruments

① Air pressure gauge --Indicate air pressure of the brake system air tank. Indicating Range: 0~1.0MPa. Normal working range should between 0.4MPa and 0.8MPa.

② Engine speed gauge--Indicate the engine speed. Indicating Range: 0~3000rpm. Normal working range should between 750rpm and 2450rpm;

③ Engine oil pressure gauge - Indicate the oil pressure of engine. Indicating range: 0~1.0Mpa.

**When the index at red area, please parking the machine and check immediately.**

**Do not operate or move the loader until the failure has been removed!!!**

4 Engine water temperature gauge - Indicate the cooling water of the engine. The indicating range: 40°C~120°C, the normal working range should between 40°C and 120°C.



**If the engine water temperature is above 106°C and the engine works, please park**

**the loader in a place safe and suitable for repair work and shut down the engine. Check the fan and belt of engine, and the water level of water tank. Do not operate or traveling the loader until the failure has been removed.**

 **Warning**

**When inspecting the radiator fan of engine, the pipeline of hydraulic motor and water level of water tank, please prepare well high temperature protection and avoid burn, keep away from the working components for fear clamping!!!**

⑤ Torque converter oil temperature gauge--Indicate the working oil temperature of the torque converter. Indicating range: 60~140°C.

 **Warning**

**When the oil temperature of the torque converter is over 120°C, park the loader in a place safe and suitable for repair work. Check the gearbox and oil level.**

**Do not operate or move the loader until the failure has been removed!!!**

**LCD panel instrument includes:**

Work hour meter--Indicate work time of loader by hours. Indicating Range: 0~9999.99 hours. The work hour meter begins to time when the engine is started by the starter switch.

Fuel oil level gauge - indicate the fuel oil level of the machine, the oil level is the highest when the gauge indicates "1", the oil level is the lowest when the gauge indicates "0", and it should be added fuel oil when the number lower than 1/8.

Voltage meter--Indicate the machine working voltage. Indicating range: 16~32V.

**Instrument display indicating lamps include:**

Left, right steering indicator (green)

Push the middle joystick on the combination switch one gear backwards; the right steering lamp lights up.

Push the middle joystick on the combination switch one gear forwards; the left steering lamp lights up.

High beam indicator (blue), as the headlight high beam is turned on; the high beam indicator lamp lights up.

Hand brake indicator lamp (red). The hand brake button bounces up and the indicator lamp lights up.

Cold start indicator lamp (red), the indicator lamps on as the cold start device operating.

Battery charging indicator (red), the indicator lamps on when the engine pressure lower than battery pressure.

 **Warning**

**In the case of any alarm, stop to inspect the loader immediately. Do not operate or**

**move the loader until the failure has been resolved!**

### **3.9.2 HORN SWITCH**

The horn switch is arranged at the center of steering wheel. Press the horn switch, the horn will blare.



### **3.10 SWITCH OF AIR CONDITIONING SYSTEM**

1. Air volume switch: used to control the revolving speed of the evaporating fan to select an appropriate air volume.

2. Refrigeration indicator lamp: Green light indicates that the refrigerating system started by the compressor is working.

3. Refrigeration switch: used to control the working of air-conditioning compressor and adjust temperatures.

4. Fresh air switch: used to take in fresh air and conduct air exchange.

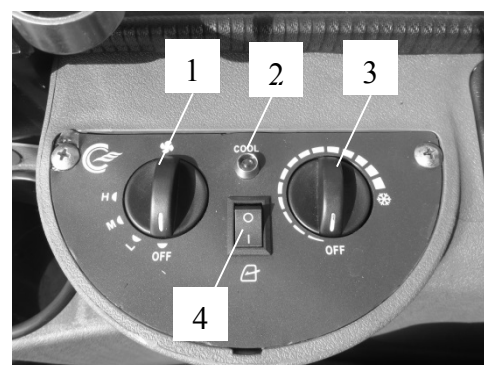

**Refrigeration:** For first use of the refrigeration system, start the engine and then turn the air volume switch to the H gear. After 5 minutes' operation, turn on the refrigeration switch. When the temperature in the compartment is above the set temperature, the green indicator lamp is lit up, the compressor starts automatically and the system begins the refrigeration process. When the temperature in the compartment is below the set temperature, the green indicator lamp goes out and the refrigeration system stops its operation.

**Adjust the angle of air outlet to change the angle and direction of cold blast:** Adjust air volume switch to obtain three grades of air volume, i.e., high, medium and low.

**Note:** Be sure to turn off the heater valve for heat exchanger during refrigeration in summer.

#### **3.10.1 WARM WATER VALVE**

The engine coolant absorbs engine heat and flows through the evaporator of air conditioning system, and the evaporator then disperses the heat, that's how the air conditioning system perform the heating function. Two manual warm water valves are mounted to the water inlet and outlet of evaporator, respectively.

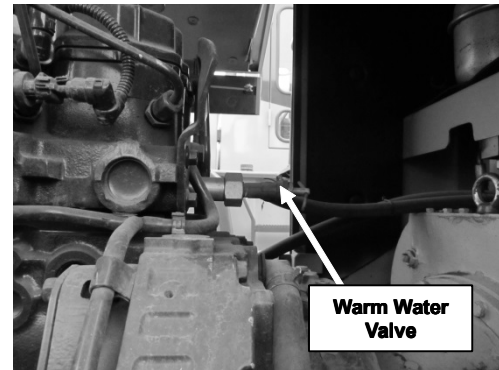

When the air conditioning system is in operation, the two warm water valves should remain open (counterclockwise turn their controls). To repair the air conditioning system, close the two valves first (clockwise turn their controls). Failure to do so may result in engine coolant loss. To renew engine coolant, open the warm water valves so as to also renew the coolant of evaporator, as well as ensure the normal level of engine coolant.

 **Warning**

**If the ambient temperature falls below 0 °C , the engine is not working, and the engine coolant contains no anti-freezer, then empty the engine water tank and open the two warm water valves, to drain the coolant in the evaporator. Otherwise the radiator pipe may break due to extra-low temperature.**

### 3.11 SEAT ADJUSTMENT

In light of the operator needs and work conditions, the operator seat is designed to be adjustable in the following items: hardness (rigidity), front-rear direction, height direction and backrest angle.

#### **Forward and backward adjustments to seat**

- A handle is provided in the lower front portion of seat. Pulling up the handle can move the seat horizontally. While moving the seat, you will feel increased resistances at some locations. These locations are used to hold the seat, that is, if you release the handle at one of these locations, the seat will be held on that location. The seat can be moved forwards by 75mm and backward by 30mm, and can only be held on the said locations.
- The seat can be adjusted to three heights by means of the two “UP” keys that are provided on the right of the seat.



### **Adjustment to backrest angle**

A handle is provided in the lower left portion of seat. Turning clockwise the handle can press the backrest forward or backward to expected position. Release the handle, the backrest will remain at that position. The backrest can be adjusted at most 12.5° forward and at most 15° backward.



### **Height adjustment of seat headrest**

Hold the seat headrest with both hands and pull up or press down the headrest steadily and forcefully to adjust the height of seat headrest.

### **Adjustment to seat flexibility (rigidity adjustment)**

A weight adjusting handle is provided in the lower front portion of seat. This weight adjusting handle is used to adjust the flexibility to meet operator need. The weight adjusting handle can be turned clockwise or counterclockwise. There is a weight indicate or near the handle. By turning the weight adjusting handle, the weight indicator will indicate a different value, meaning the most suitable weight of operator relative to the current seat rigidity. The seat flexibility can be steplessly adjusted from 50kg to 130kg, and the rigidity set by the loader manufacturer is 70kg.



## **3.12 SAFETY BELT**

The loader is provided with a safety belt. The operator should fasten the safety belt when operating the loader, but he should first inspect the safety belt for worn or loose part. If necessary, replace the safety belt.

Before using the safety belt, adjust its length to ensure the good functioning and comfort of safety belt. The length of safety belt can be adjusted by moving the position of buckle in safety belt. The anchorage of safety belt is arranged in the rear right portion of seat. Insert the buckle into the opening of anchorage. The



anchorage will lock the buckle.

Press the red button near the anchorage, the buckle will spring out.

Before using the safety belt, inspect the anchorage.



### 3.13 CAB DOOR LOCK

The keys to the right and left doors of Cab are the same. If the door is locked, the core of lock cannot be pressed down with the thumb. To open the door, insert the key into the lock core, clockwise turn the key for 180° and then take it out, press down the lock core and pull out the door. To close the door, insert the key into the lock core, counterclockwise turn the key for 180° and then take it out.

### 3.14 USE OF LOCATING LOCK

If the cab door opens 180°, the locating lock will be caught by the lock catch, which is outside the cab. The control handle of locating lock is arranged in the middle of door. Pressing down the handle will release the locating lock, to close the door.

Locating lock

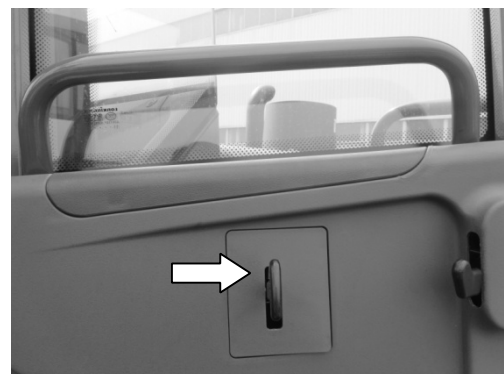

#### **Warning**

Before operating the loader, the operator must close both the left and right doors, to ensure safety.



### 3.15 ADJUSTMENT TO REAR-VIEW MIRROR

A rear-view mirror is installed on the left and right front of Cab top, respectively. Adjust the rear-view mirrors to correct positions before operating the loader.

To adjust the position of rear-view mirror, loosen the bolt that fastens the rear-view mirror support to the Cab, and then rotate the support. Loosen the connection bolt between rear-view mirror and support, rotate rear-view mirror to the right position. Then tighten the bolt.

### 3.16 TURNING LAMPS AND FULL-BEAM/LOW-BEAM HEADLIGHTS

The loader has the control switches for turning lamps and full-beam/low-beam headlights. They are located below the right side of cab steering wheel.

Turning lamp and full-beam/low-beam headlight switches

1. Turning lamp switch

This switch is used to turn on and off turning lamps when the loader turns.

2. Full-beam/low-beam headlight switch

Rotating control handle is used to turn on and off full-beam and low-beam headlights.



### 3.17 CHARGING DOCK

Reserved for charging of cigarette lighter and mobile phone.

(Figure 1) 12V 100W

(Figure 2) 24V 120W



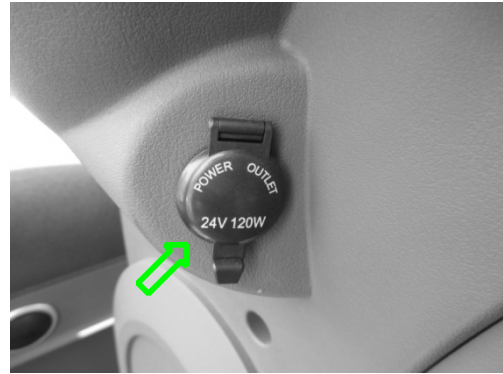

### 3.18 SUNSHADE

1. Pull the handle lever in the middle by hand to unroll the sunshade cloth. Pull to an appropriate position and release the lever, and the sunshade will stop at that position; if the position is not appropriate, continue to pull the lever to the maximum position of travel. When the lever is pulled near the maximum position of travel, reduce the pull force for fear of damage to the sunshade.

2. When the sunshade is at the lower maximum position of travel, pull the curtain bell on the left to cause the sunshade to move up. Release the bell quickly at this time, and the sunshade will stop at the corresponding position. Pull the bell again, and the sunshade will continue to move up until the sunshade cloth returns to its original position.



### 3.19 PLAYER

#### Basic operations:

#### 1. LCD screen

In the starting state, the screen displays the radio frequency and current play message.

#### 2. Power switch/pause/radio station selection button

In the standby state, press the button shortly to start the player and press the button long to turn off the player.

In the MP3 play state, press the button shortly to pause the playing; press the button shortly again to resume the playing.

In the radio receiving state, press the button shortly to select from already saved radio station



s (in the present wave band, select radio stations cyclically; press the AMS/BND button to switch to the other wave band.)

### **3. Mode conversion/mute button (MOD/MUT)**

In the starting state, press the button long to conduct mode conversion: radio – U disk – SD card; press the button to mute, and press the button long again to unmute.

### **4. Volume up/forward selection/forward search button**

Press the button long to turn up the volume; in the MP3 state press the button shortly to select music pieces forward; in the radio receiving state, press the button shortly to search radio stations towards high end semi-automatically.

### **5. Volume down/backward selection/backward search button**

Press the button long to turn down the volume; in the MP3 state, press the button shortly to select music pieces backward; in the radio receiving state, press the button shortly to search radio stations towards low end semi-automatically.

### **6. Clock button (CLK)**

Press the button to display the clock. In the clock state, press the button for 3 seconds to enter clock setting and display clock flashing. At this time press the “VOA+” button to gradually increase hour setting, and press the “VOA-” button to gradually decrease hour setting; press the “CLK” button shortly again to enter the minute setting. At this time press the “VOA+” button to gradually increase minute setting, and press the “VOA-” button to gradually decrease minute setting.

### **7. Wave band/automatic station saving button (AMS/BND)**

In the radio receiving state, press the button shortly to conduct waveband conversion (FM1-FM2-FM3), and press the button long to automatically search radio stations and store the searched radio stations in order. After one round of automatic radio station search, automatically play the programs of the first pre-stored radio station.

### **8. U-disk socket**

Insert a U disk to automatically play music pieces in the corresponding format (MP3) and meanwhile display the corresponding indicative icon.

### **9. SD/MMC card socket**

Insert a SD/MMC card to automatically play music pieces in the corresponding format (MP3) and meanwhile display the corresponding indicative icon.

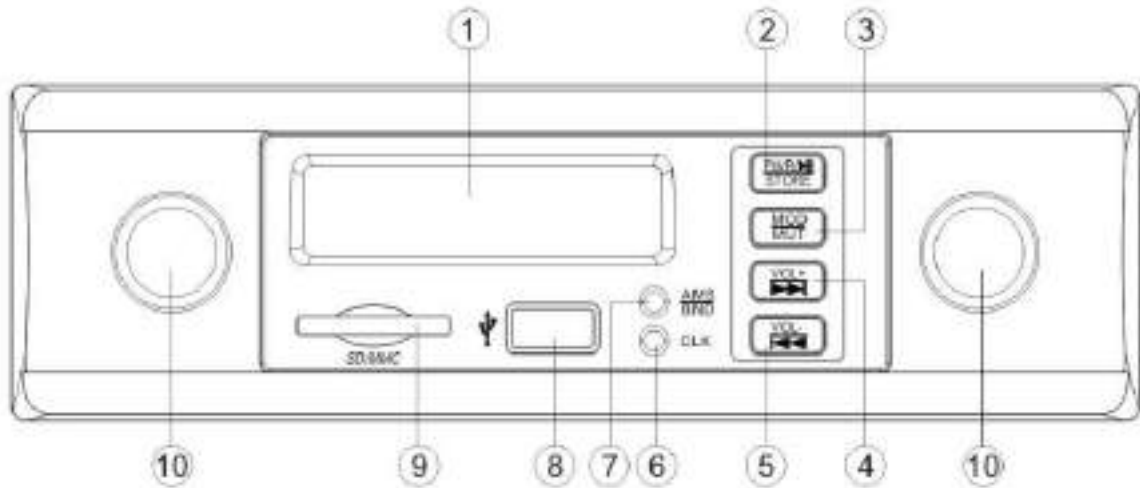

1.LCD screen

2. Power switch/pause/radio station selection button

3. Mode conversion/mute button

4. Volume up/forward selection/forward search button

5. Volume down/backward selection/backward search button

6. Clock button

7. Waveband/automatic station saving button

8. U-disk socket

9.SD/MMC card socket

10. Decorative knob

# CHAPTER IV OPERATION

## 4.1 NOTICES ON OPERATION OF NW LOADER

Even though each loader is properly inspected and adjusted before leaving the factory, it is still necessary to abide by the following procedures during the running-in period, otherwise the loader may get damaged or its performance may be reduced.

If the loader works under fully-loaded state before the expiration of the running-in period, this will adversely affect the service life and safe operation, and finally cause fault.

### **NOTE:**

- 1) Inspect whether the coolant, fuel, engine oil or hydraulic oil leaks every day.
- 2) Inspect the lubricating fluid every day and fill the lubricating fluid if necessary.
- 3) In the course of operation, pay attention to the instrument board and the indication of various instruments from time to time.
- 4) Prevent the engine from getting overloaded.
- 5) Before the engine and other parts reach the operating temperature, remain the load less than 80% of the rated load.
- 6) In the course of working, inspect whether the work attachment is normal.
- 7) Inspect whether any part is loosened or damaged owing to the transportation.
- 8) Inspect whether any wire or terminal is loosened, whether the instruments work normally, and whether the electrolyte is sufficient.
- 9) After running the engine, it should be idle running 3-5min, and then working normally.

### Lubricating fluid and filter element

1. Replace the engine oil and engine oil filter element 50 hours after the loader works for the first time.
2. Replace the slewing reduction gear oil 250 hours after the loader works for the first time.
3. Replace hydraulic oil filter element 250 hours after the loader works for the first time.
4. Replace the travelling reduction gear oil 250 hours after the loader works for the first time.

**NOTE: when replacing the lubricating oil or grease, please refer to the relevant contents in Section “Inspection, Maintenance and Adjustment.”**

## **4.2 RUNNING-IN OF NEW LOADER**

For a new loader, the running-in will play an important role in prolonging the service life of the loader, eliminating hidden faults and avoiding the occurrence of serious fault. The user shall carry out operation and maintenance in accordance with the provisions relating to running-in of new loader as specified in this Manual after purchasing the loader, and then the loader may be used normally.

### **4.2.1 REQUIREMENTS ON RUNNING-IN OF NEW LOADER**

1. The running-in period for a new loader is 100 hours
2. After the engine is started up, make it run at idle speed for 5 minutes
3. During the running-in period, the forward and reverse gears shall be arranged for running-in respectively. When starting up the loader, the accelerator pedal shall be pushed down smoothly and slightly, the speed shall then be increased gradually, and violent braking shall be avoided.
4. During the running-in period, it is advised to work with bulk materials only, and the traveling may not be carried out too violently. During the running-in period, the load on the loader may not exceed 70% of the rated load.
5. Pay attention to the lubrication of the loader, and replace or add lubricating oil and grease in accordance with the specified interval.
6. Pay attention to the temperature of gearbox, torque converter, front/rear axle, wheel hub, parking brake, intermediate supporting shaft, hydraulic oil, engine coolant and engine oil, and identify and eliminate the cause if overheating is found.
7. Inspect whether the bolts and nuts of all parts are properly tightened up.

### **4.2.2 OPERATIONS TO BE CARRIED OUT AFTER EIGHT HOURS OF RUNNING-IN**

1. Inspect the tightening of all bolts and nuts, especially diesel engine cylinder head bolts, exhaust pipe bolts/nuts, front/rear axle fixing bolts, wheel rim nuts, transmission shaft connecting bolts, diesel engine fixing bolts, gearbox fixing bolts and frame articulating bolts.
2. Inspect the tension of generator belt and air belt.
3. Inspect the level of transmission oil, drive axle oil and engine oil.
4. Inspect the sealing property of hydraulic system and brake system.
5. Inspect the connection of each control handle and throttle lever.

6. Inspect the temperature and connection of each part of electrical systems, the power supply to engine, the conditions and lightening devices and turn lamps.

**NOTE: when inspecting the level of any oil or fluid, be sure to follow the relevant operating procedure.**

### **4.2.3 OPERATIONS TO BE CARRIED OUT AFTER EXPIRATION OF RUNNING-PERIODS**

1. Inspect the tightening of all bolts and nuts, especially diesel engine cylinder head bolts, exhaust pipe bolts/nuts, front/rear axle fixing bolts, wheel rim nuts, transmission shaft connecting bolts, diesel engine fixing bolts, gearbox fixing bolts and frame articulating bolts.
2. Inspect the tension of generator belt and air compressor belt.
3. Inspect the sealing property of hydraulic system and brake system.
4. Replace the transmission oil and drive axle lubricating oil.
5. Replace the transmission oil filter, engine oil filter and diesel filter element.
6. Clean up the return filter element of the hydraulic oil reservoir.

**NOTE: When replacing the transmission oil, drive axle lubricating oil and transmission oil filter, be sure to follow relevant procedure as specified in Chapter "Maintenance."**

## **4.3 OPERATION OF LOADER**

### **4.3.1 INSPECTION BEFORE STARTUP OF ENGINE**

1. Inspect the level of engine coolant.
2. Inspect the level of engine oil.
3. Inspect the level of hydraulic oil in the hydraulic oil tank.
4. Inspect the sealing property of each oil pipe, water pipe and part.
5. Inspect the wiring of battery, and, if the connection between electrode and cable of the battery is loosened, tighten it up in time.
6. Inspect whether the tire pressure is correct.

Figure: Inspect the wiring of battery. Connect the wiring according to the figure.



### 4.3.2 STARTUP OF ENGINE

1. Clear away the persons around the loader and the obstacles in the travelling direction of the loader; inspect whether there is any person under the loader; except for the driver who may sit in the cab for operating the loader, no other person may stand on any portion of the loader.
2. Turn on the negative pole switch of the battery.
3. Go up and go down the stairs in accordance with the relevant safety provisions.
4. Adjust the rear view mirror, so as to obtain a good rear vision which is as closer to the loader as possible.
5. Close the left and right doors of the cab.
6. Inspect whether the seatbelt is in good conditions, and then properly fasten the seatbelt.
7. Inspect whether the gear-shift lever is at the neutral position; if not, please set the gear-shift lever at the neutral position.
8. Inspect whether the pilot joystick is at the middle position; if not, please set it at the middle position.
9. Inspect whether the fan switch and A/C switch of A/C system are at the off position; if not, please set them at the off position.
10. Insert the key into the electric lock and then turn it clockwise by one step so as to turn on the power supply, and then sound the horn so as to declare that the loader is about to start up and no other person may approach the loader.
11. Inspect the level of fuel.
12. Slightly push down the accelerator pedal, and turn the key clockwise by one more step so as to switch on the engine starting motor. Under normal conditions, the engine can be started up within 10 seconds, and then please release the key immediately so as to let the electric lock return to the original position.

**NOTE: An attempt to start up the engine may not last for more than 15 seconds (the starting motor may not work continuously for more than 15 seconds), and if the engine cannot be started up, please immediately release the starter**



**switch, wait at least 30 seconds and then attempts to start up the engine again. This is jointly required by the features of starting motor and battery. If the loader cannot be started up in three attempts, please carry out inspection, eliminate the fault, wait at least three minutes, and then attempt to start up the engine again.**

13. After the engine is started up, make it run at idle speed (700~800r/min) so as to warm it up. Only after the temperature of the diesel engine cooling water reaches 55°C and the temperature of engine oil reaches 45°C may the fully-loaded operation be carried out.
14. When the engine is running at low speed, listen whether the engine works normally and whether the gearbox makes any abnormal noise.
15. Inspect whether each instrument works normally and whether each lighting device, indicating lamp, horn, wiper and brake lamp can work normally.

**NOTE: Pay special attention to the engine oil pressure. The value indicated may not be less than 0.07MPa (idle state). If the indicated value is less than this figure, please stop the loader, inspect whether there is any fault with the diesel engine. After the electric lock is turned on, the low brake pressure warning lamp will flash, and the warning buzzer will sound; about half a minute after the engine is started up, the low service brake pressure warning lamp shall go out. The warning buzzer shall stop. If not, please inspect whether there is any fault with the brake system.**

16. In cold season, please preheat the hydraulic oil. Push backwards the pilot joystick and hold it there for 4-5 minutes, and at the same time push down the accelerator pedal, so as to make the stopper of the bucket is pressed against the lift arm and make the hydraulic oil overflow. In this way, the temperature of hydraulic oil will increase rapidly.
17. If there is no obstacle around the loader, please turn the steering wheel slowly, and observe whether the loader turns.

### **4.3.3 TRAVELLING OF LOADER**

1. Operate the pilot control valve handle so as to move the bucket backwards to the limit state; raise the lift arm to the transportation position, namely the position whereby the lower articulated point of the lift arm is 500-600mm above the ground.

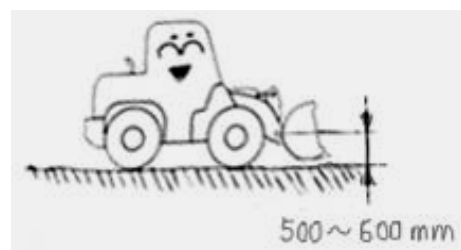

2. Step down the service brake pedal, rotate the handle brake button to reset it, slowly let go of the service brake pedal, and observe whether the loader moves.



**WARNING: If the loader moves, immediately step down the service brake pedal, rotate the hand brake button to reset it and apply the braking. Thereafter, inspect whether there is any fault with the gear-shifting control system. If the loader is on a slope, be sure to block up all wheels with chocks so as to prevent the loader from moving, and then operate the loader.**

3. Push the control handle so as to get the forward gear 1 engaged or pull the gear-shifting lever backwards so as to get the reverse gear 1 engaged, and at the same time push down the accelerator pedal appropriately. In this way, the loader will travel forwards or backwards.
4. Inspect the engagement of each gear. Drive the loader to a flat and open ground, get each gear engaged respectively, and inspect the gear-shifting operation. If in the operation of the previous phase, the inspection on steering performance was not carried out owing to the small place, please turn the steering wheel now, and inspect whether the loader can turn left or right.



**NOTE: When carrying out gear-shifting operation, release the accelerator pedal firstly and then operate the gear-shifting lever for realizing the gear shifting, so as to protect the gear-shifting clutch.**

5. Inspect the performance of service brake. On a flat and open ground, drive the loader with forward gear 1 or forward gear 2 engaged, release the accelerator pedal, and at the same time smoothly push down brake pedal. The loader shall slow down obviously and then stop.

**NOTE: If you cannot feel that the loader slows down obviously after the brake pedal is stepped down, please immediately rotate the red button of parking brake so as to reset it and apply the emergency braking. At the same time, by operating the pilot joystick, lower the lift arm to the lowest position, tilt forwards the bucket, and insert the bucket teeth into or push against the ground, so as to stop the loader and ensure the safety.**

6. In case there is a corner ahead, please operate the loader in accordance with the local laws and regulations relating to traffic. When the loader is about to turn, pull or push the turn lamp handle in the corresponding direction. As indicated in the figure below, push forwards the handle if the loader will turn left, and pull backwards the handle if the loader will turn right. Now the front/rear turn lamps on one side of the loader and the corresponding turn indicating lamp on the instrument board will come on, so as to warn the loaders and persons around the loader that this loader is about to turn. Thereafter, turn the steering wheel in the turning direction, so as to make the loader to turn.



The loader is equipped with the articulated-type fully-hydraulic coaxial-flow-amplifying powered steering gear, and the turning angle of the steering wheel is not equal to the turning angle of the loader. When the steering wheel is turned continuously, the turning angle of the loader will increase until the intended angle is obtained. The turning speed of the loader will increase as the turning speed of the steering wheel increases.

After being turned, the steering wheel will not return to the original position automatically, and the turning angle of the loader will remain unchanged. Therefore, after the turning of the loader is completed, be sure to turn the steering wheel in opposite direction so as to eliminate the relative angle between front and rear frames and make the loader run straightly. After the turning operation is completed, pull the turn lamp switch to the middle position, so as to turn off the turn lamps and turn indicating lamp.

For the purpose of carrying out the turning operation when the loader is travelling at high speed, be sure to release the accelerator pedal firstly. If necessary, apply the service brake to slow down the loader and then carry out the turning operation, so as to ensure the safety.

**WARNING: Do not carry out turning operation on a slope. The turning operation may be completed only after the loader has been driven to the flat ground.**

7. For the purpose of braking the loader, just release the accelerator pedal, and then smoothly push down the brake pedal.

**WARNING: When the loader is running at high speed, unless any emergency circumstance occurs, be sure not to push down the brake pedal to the end violently, otherwise the emergency braking may cause safety accident or damage the loader.**

#### **4.3.4 PARKING OF LOADER**

- Drive the loader to a flat place which is free from the risk of falling stone, landslide or flood.
- Apply the service brake to stop the loader.
- Pull the gear-shifting lever to the neutral position.
- Rotate the hand brake button to reset it and apply the parking braking.
- Operate the pilot joystick so as to lower the lift arm, place the bucket horizontal on the ground and make the bucket press against the ground slightly.
- Make the engine run at idle speed for 5 minutes, so that all parts may cool down evenly.
- Turn the electric lock's key anticlockwise to OFF position to disconnect the control circuit. Engine stops. Pull out the key.
- Set each switch at middle position or off position.
- Close the left and right doors, and then go down the stairs in accordance with the relevant provisions.
- If the loader is to be parked for long time (for example, all the night), just open the side door of the hood and pull the negative pole switch of battery to the off position, so as to turn off the power supply.
- If no anti-freezing fluid is added in the coolant before the loader leaves the factory, just open all water drain valves of the engine after parking the loader in winter, discharge all coolant from the cooling system and the evaporator in A/C system, so as to prevent any part from being frozen and damaged. If the anti-freezing fluid is added when the loader leaves the factory, please operate as indicated in the nameplate on the rear end of the loader.
- Lock up all equipment, pull out the key and take it with you.

**NOTE: Be sure to park the loader on a flat ground. If it is necessary to park the loader on a slope, be sure to block up the wheels with chocks, so as to prevent the loader from moving.**

**If the loader is to be stored for long time, please operate in accordance with the following requirements:**

1. Before Storage
  - 1) Clean up each part of the loader, dry the loader up and then store it in a dry warehouse. If the loader can only be stored outdoors, be sure to park it on a concrete ground where water may drain easily, and cover it with canvas.
  - 2) Before storing the loader, fill the fuel tank with fuel, apply grease to each moving pin, moving shaft and transmission shaft, and replace the hydraulic oil.

- 3) Pull the gear-shifting lever to the neutral position.
- 4) Rotate the parking brake button to reset it and apply the parking braking.
- 5) Place the bucket on the ground horizontally, and pull the pilot joystick to the middle position.
- 6) Set each switch at the middle position or off position, and then lock up all doors.
- 7) Apply a thin layer of grease onto the exposed portion of the hydraulic oil cylinder piston rod.
- 8) Detach the battery from the loader and place it separately.
- 9) If the atmospheric temperature may reduce below 0 °C, please add anti-freezing fluid into the engine coolant, and make the anti-freezing fluid reach the engine and the evaporator of A/C system. Alternatively, discharge all water in the cooling system, and also discharge all water in the evaporator of A/C system.
- 10) Fix the front/rear frames with the frame fixing rods.

## 2. During Storage

- 1) Start up the engine once a month, run each system, and apply lubricating oil/grease to all moving pins/shafts and the transmission shaft so as to get all moving parts well lubricated. In addition, charge the battery.
- 2) Before starting up the loader, wipe away the grease on the hydraulic oil cylinder piston rod.
- 3) Apply antirust agent to all portions which may get rusted.

**NOTE: If the antirust agent is used indoors, be sure to open doors and windows, so as to get the place well ventilated and discharge the toxic gas.**

## 3. After Storage

When the loader is to be used after long-term storage, be sure to carry out the following operations:

- Replace the lubricating oil of engine, gearbox and drive axle as well as the hydraulic oil and anti-freezing fluid.
- Apply greases to all moving pins/shafts and the transmission shaft.
- Before starting up the engine, wipe away the grease from the hydraulic oil cylinder piston rod.

## 4.4 WORKING OF LOADER

### 4.4.1 PREPARATION BEFORE WORKING

- Before the commencement of the working, use the loader to flatten the working place, remove crowing portions, fill depressions, and remove the ground surface which is wet and slippery. Clear away all large and sharp stones on the working place, so as to prevent the tires from being scratched.
- If using the loader to load materials onto or unload materials from a truck or hopper, adjust the limit height of the caging device of the lift arm on the basis of the height of the truck or hopper, so as to ensure that the bucket may safely enter into and exit from the truck or hopper and to avoid the impact on truck or hopper imposed by materials discharged from an excessively high position.

### 4.4.2 GENERAL TECHNIQUES

#### Common shovel-loading method

- The common shovel-loading method is suitable for the loading of bulk materials.
- Make the loader approach the materials at the speed under forward gear 2, align the middle portion of the bucket with the material pile, hold the steering wheel with your left hand, and operate the pilot joystick with your right hand so as to lower the lift arm to the position which is 500mm above the ground.
- When the loader is about one meter away from the material pile, lower the lift arm again and make the bucket contact with the ground, and then change the forward gear 2 to forward gear 1.

**NOTE: When making the bucket contact with the ground, be sure not to make the bucket apply a too large force onto the ground, otherwise the unnecessary travelling resistance may occur. In addition, the front/rear frames of the loader shall be placed straightly, and there must be no included angle between front and rear frames.**

- Push down the accelerator pedal so as to insert the bucket into the material pile with full force; when the loader cannot move forward any more, push leftwards the pilot joystick so as to turn the bucket backwards, and then pull the control handle to the middle position. In this way, the loader may go ahead into the material pile. Repeat the operation mentioned above until the bucket is filled with the material.

#### Combined shovel-loading method

- The combined shovel-loading method is suitable for loading relatively hard or sticky materials. Before the bucket is inserted into the materials, all operations are the same as those of common shovel-loading method. When the bucket cannot move forwards

any more after being inserted into the material pile, just pull backwards the joystick with your right hand and then push it to the middle position, so as to lift up the bucket for once. In this way, the bucket may go ahead for certain distance. Thereafter, push forwards the pilot joystick and then push it to the middle position, so as to turn backwards the bucket for once. In this way, the bucket may get further inserted into the material pile. Repeat the operation “insertion, lifting, inserting and turning” until the bucket is filled with materials.

### **Exiting from material pile**

- After the bucket is filled with materials, just operate the pilot joystick so as to turn backwards the bucket until the stopper on the bucket contacts with the lift arm, and then push the pilot joystick to the middle position. Now the maximum rollback angle is obtained.
- Raise the lift arm to a certain height, so as to ensure that the bucket may evade the material pile when the loader is travelling backwards. Just hold the steering wheel with your right hand, and pull backwards the gear-shifting lever to the reverse gear position with your left hand, so as to make the loader travel backwards.
- After the loader exits from the material pile, just operate the pilot joystick so as to lower the lift arm to the position whereby the lower linkage point of the lift arm is about 50cm above the ground.

### **Handling of materials**

- Under any of the following circumstances, the self-handling may be carried out:
  - ① The road is soft, the place is not flattened, and it is impossible to use freight vehicle.
  - ② The handling distance is no more than 500 meters, and the use of freight vehicle is not economical.
- In the course of handling, remain the lower linkage point of the lift arm at the articulating position (about 50cm above the ground), and turn backwards the bucket to the limit position (the stopper on the bucket contacts with the lift arm), so as to ensure that the handling operation may be carried out safely and smoothly and no material will fall out.
- The speed of the loader in the course of handling operation depends on the handling distance and road conditions. When passing any depression or crowing portion, just release the accelerator pedal, and, if necessary, intermittently apply the service brake, so as to slow down the loader, make the loader pass the obstacle slowly, reduce the impact to the loader and prevent the materials from falling down.

**WARNING: Do not lift up the bucket to a relatively high position for carrying out the handling operation, otherwise the loader may overturn.**

### **Unloading of materials**

① Discharging of materials into truck or hopper

- When the loader which is loaded with materials is 15 meters away from the truck or hopper, just release the accelerator pedal, and if necessary, intermittently apply the service brake, so as to slow down the loader and make the loader approaches the truck or hopper at a low speed. At the same time, pull the pilot joystick backwards to the limit position until the control handle is caught up by electromagnet, and then release the control handle (the handle will not return to the middle position automatically). The lift arm will rise continuously until it reaches the limit height, and then the electromagnet will be de-energized, the pilot joystick will automatically return to the middle position, and the lift arm will not rise any more. In this course, the driver shall carefully drive the loader, carefully observe the approach by the bucket to the truck or hopper, and may not make the bucket collide with the truck or hopper.
- When the bucket is above the truck or hopper, just push down the brake pedal so as to stop the loader, push rightwards the pilot joystick so as to tilt forwards the bucket, and then discharge the materials into the truck or hopper. At this time, be sure to carefully observe the movement of the bucket, and be sure not to make the bucket collide with the truck or hopper. If the material is very sticky, just push and pull the control handle repeatedly, so as to make the stopped of the bucket collide with the lift arm repeatedly, so as to make the materials fall down from the bucket.
- If the length of the truck exceeds two times the width of the bucket, the unloading operation shall be started with the materials on the front portion of the truck.

**NOTE: Be sure not to make the stopper collide with the lift arm too violently or too frequently, otherwise the loader may get damaged.**

- After all materials are unloaded, just pull the pilot joystick backwards to the limit position until the control handle is caught up by the electromagnet, and then release the control handle (the handle will not return to the middle position automatically). The bucket will turn backwards continuously until it is in the horizontal position, and then the electromagnet will be de-energized and the pilot joystick will automatically return to the retaining position. Thereafter, just pull backwards the gear-shifting handle to the reverse gear position, and then release the brake pedal, so as to make the loader leaves the truck or hopper.
- After the bucket fully leaves the truck or hopper, just lower the lift arm while the loader the travelling, so as to get ready for the next working cycle.

② Discharging of materials at lower position

- When being handled between different places, sometimes the materials may be discharged at lower position, which means that the materials are discharged with the bucket located at a position close to ground. In this case, after the materials are discharged, be sure to turn backwards the bucket until it is in the horizontal position and then raise the lift arm, otherwise it is likely that the lift arm cannot be raised up owing to the interference caused by the linkage of work attachment.



### **Push-transportation**

- Place the bucket horizontally close to the ground, set the gear-shifting level at the position of forward gear 1, and then push down the accelerator pedal, so as to make the loader move forwards. If an obstacle is found in the course of working, just slightly raise the lift arm and go ahead. When raising or lowering the lift arm, the pilot joystick shall be operated between lowering position and lifting position and may not be fixed at lifting position or lowering position, so as to ensure the smooth progress of the working.

### **Scraping**

- Raise up the lift arm until it is about 1100mm above the ground, and tilt the bucket forwards until its scraper contacts with the ground and the included angle between the scraper and the ground is about 45°. In case the road is hard, just place the pilot joystick at the floating position; in case the road is soft, just place the control handle at the middle position. Pull the gear-shifting lever to the reverse gear position, and then push down accelerator pedal, so as to make the loader travel backwards and use the bucket scraper to scrape the ground.

### **Traction**

- The loader may be towed by a 20-ton towing tractor for transportation. The method is detailed as follows.
- Firmly connect the towing tractor to the towing pin of the loader.
- The towing tractor shall be equipped with the brake system with good performance.
- Place the bucket at the transportation position.
- All actions shall be slight and smooth when starting up or stopping the loader, and brake shall be applied before going down along a slope.

**NOTE: When applying the brake, be sure to brake the towing tractor firstly, and then brake the loader.**

### **4.4.3 WORK METHOD**

- V-type work method
- Align the loader with the material pile, keep the included angle between the truck and the travelling direction of the loader at 60°, and stop the loader about 12-15m away from the material pile. After the bucket is filled with materials, make the loader travel backwards until it is 12-15m away from the material pile. Therefore, turn the loader and drive it towards the truck and at the same time lift up the bucket. After the materials are discharged, return to the original position for the next shovel-loading operation.
- Shuttling work method

- The shuttling work method is mainly used for the combined work of loader and truck fleet. As indicated in the figure below, after the loader is loaded with materials, it will travel backwards by 2-3 times the width of the truck. Thereafter, the truck will run along one side of the loader and stop in front of the loader. The loader will go ahead and raise up the lift arm. After the materials are discharged, the loader will travel backwards to the original position. If the truck is not fully loaded, the truck will go ahead by the width of the truck. After completing the next shovel-loading operation, the loader will return to the original position, and then the truck which is not fully loaded will travel backwards until it is in front of the loader, and now the loader will discharge the materials onto the truck. Repeat this operation until the truck is fully loaded, and then load the next truck. This working method requires the close cooperation between the loader driver and the truck driver, and, if necessary, the use of horn, light or gesture for communication.

Figure: Shuttling Work Method

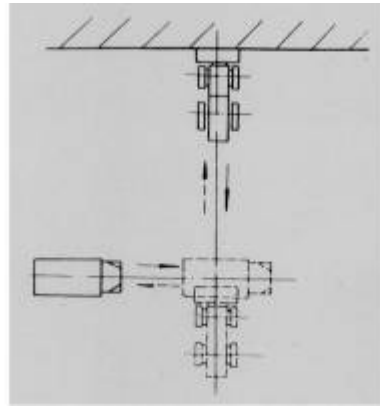

## 4.5 TRANSPORTATION OF LOADER

Before the transportation, be sure to survey the height, width and permissible load of the transportation course. The total height, total width and total weight after the loader is placed on the transportation vehicle may not exceed the specified value. If the height or width exceeds the specified value, please consult with LONKING Holdings Limited or its distributor for solution.

In order to prevent the safety accident caused by unexpected movement or sliding of the loader in the course of transportation, be sure to clear away ice, snow and other slippery materials on the dock or vehicle before the transportation.

**NOTE: When transporting the loader, please comply with the national or local regulations relating to height, width, length and weight.**

Please carry out the transportation in accordance with the following procedure:

- ① Before the transportation, be sure to block up the wheels of the towing tractor or truck with chock (towing tractor in the figure).

Figure: Use Chock to Block up the Wheels of the Towing Tractor

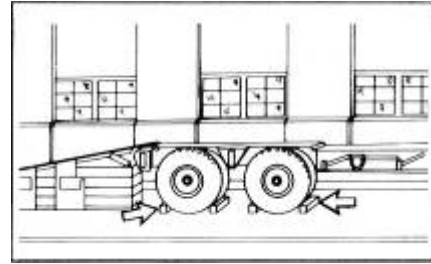

2. After the loader has driven onto the towing tractor or truck, no turning operation may be carried out in the course of transportation. If it is necessary to carry out turning operation, please carry out the operation only after the loader has returned to flat ground.
3. After the loader is parked properly, use the bumper to fix the front/rear frames.

Figure: Installation of frame fixing rod



4. Horizontally place the bucket on the transportation vehicle, and then set the control handle at the neutral position.
5. Pull the pilot joystick to the middle position.
6. Rotate the parking brake button to reset it.
7. Turn off the engine, set all switch at middle position or off position, and then pull out the electric lock key.
8. Properly close and lock all doors, and then pull out the key.
9. Pull the negative pole switch of battery to the OFF position.
10. When using a truck or towing tractor to transport the loader, be sure to use chocks to block up the wheels and use wire ropes to fix the loader, so as to prevent the loader from moving in the course of transportation.

#### **4.5.1 HOISTING OF LOADER**

1. The hoisting operation shall be commanded and carried out by professionals who

have the hoisting-related knowledge.

2. Please calculate the maximum hoisting weight of crane and the loading capacity of sling (the weight of loader is  $12300\pm 300$  kg), so as to ensure the safety. In addition, please ensure that the four hooks on the sling will be under even stress.
3. Before the hoisting operation, be sure to carry out the following preparation:
  - ① Set the control handle at the neutral position.
  - ② Place the lift arm and bucket at the lowest position, pull the pilot valve joystick to the middle position.
  - ③ Rotate the parking brake solenoid valve switch to reset it.
  - ④ Shut down the engine and pull the key out from the electric lock.
  - ⑤ Close and lock up all doors.
1. Pull the negative pole switch of battery to the off position.
2. Fix the front/rear frames with the frame fixing rod, so as to prevent the loader from turning.
3. The sling shall be firmly fixed onto the lug on the loader which is marked with the hoisting sign.

Figure: Hoisting Sign



**WARNING: Incorrect hoisting operation may get the loader displaced and then cause personal injury or property damage.**

#### **Towing of loader in trouble**

Except in emergency circumstances, the loader cannot be towed. In case towing operation is carried out, the distance must be short and necessary for moving the loader to a place where inspection and repair can be carried out. In the course of the towing operation, the speed may not exceed 2km/h; otherwise the gearbox may get damaged owing to insufficient supply of oil. If long-distance movement is required, please use special towing tractor.

**WARNING: Incorrectly towing a loader may cause personal injury.**

If the loader in trouble is towed on a bad road, it will further damaged.

If the brake system fails, the brake is out of use, and special attention shall be paid in the course of towing operation.

Precautions for towing operation:

1. Unless the driver may control the direction and/or brake of the loader, no person may stay on the loader which is being towed.
2. Before the towing operation, make sure that the towing rope or towing rod is in good conditions and has the enough strength to tow the loader. The strength of the towing rope or towing rod used shall be at least 1.5 times the gross weight of the loader to be towed, so as to ensure that the loader can be pulled up from mud or along a slope.
3. The angle of the towing rope shall be minimized, and the included angle between the towing rope and travelling direction may not exceed 30°.
4. Too quick movement of the loader may get the towing rope or towing rod broken. Better effect may be obtained if the loader moves slowly and smoothly.
5. In the course of towing operation, all persons shall keep away from the towing rope, so as to avoid the personal injury caused by the broken towing rope.
6. Under normal conditions, the towing tractor shall be of the same size as the loader to be towed. It shall be ensured that the towing tractor has enough braking ability, weight and power to control two loaders.
7. When going down along a slope, in order to ensure that the loader towed can be properly controlled and braked, a towing tractor or another loader of larger size shall be connected to the rear end of the loader towed, so as to prevent it from being out of control and overturning.
8. If the direction of the loader towed is controlled by the driver, the driver shall turn along the direction of the towing rope.

**NOTE: Before releasing the brake, be sure to block up the wheels of the loader with chock, so as to prevent the loader from moving. If the loader is not properly blocked up, it may slide. Take away those chocks before the towing operation will commence.**

- 1) To tow the loader with the engine running
  1. If the power train and the steering system may work normally, the loader may be towed for a short distance with the engine running, so as to draw the loader out from muddy road or to the side of road.
  2. If the service brake system and the parking brake system can work normally, just press down the parking brake handle and push down the parking brake button before the towing operation.
  3. The driver of the loader towed shall turn the steering wheel correspondent to the travelling direction.

2) To tow the loader with the engine switched off

If the engine fails, please tow the loader in accordance with the following method.

If the service brake system and parking brake system is properly sealed with no leakage, the pressure oil in the energy accumulator may be used to release parking brake. In this case, the pressure oil in the energy accumulator can only be used for 6~7 times. Please use it cautiously. If the parking brake system leaks and the pressure oil in the energy accumulator is not high enough to release the parking brake, please dismantle the front/rear transmission shafts and get the loader towed.

① Place the gear position of the gearbox in neutral position.

Figure: Dismantlement of Front/Rear Transmission Shafts



If it is suspected that the gearbox fails, just dismantle the front/rear transmission shafts and then get the loader towed.

## **4.6 OPERATION IN COLD WEATHER**

### **4.6.1 PRECAUTIONS FOR OPERATION AT LOW TEMPERATURE**

If the ambient temperature is too low, it will be difficult to start up the engine and the radiator may get frozen. Therefore, the following operations shall be carried out:

1. Only low-viscosity fuel, hydraulic oil and lubricating oil may be used, and anti-freezing fluid must be added into engine coolant.
2. Precautions for use of anti-freezing fluid:

- Be sure not to use any anti-freezing fluid which contains methanol, ethanol or propanol.
- Be sure not to use any anti-leakage agent, no matter it is used alone or together with anti-freezing fluid.
- Be sure not to mix up anti-freezing fluids of different designation.
- When replacing the anti-freezing fluid, please refer to the nameplate on the rear end of the loader for the concentration of anti-freezing fluid.

**NOTE: The anti-freezing fluid shall be kept away from open flame, and no smoking is permitted when filling the anti-freezing fluid.**

### 3. Precautions for Use of Battery

1. When the ambient temperature lowers, the capacity of the battery will reduce. If the charging rate of the battery is too low, the electrolyte may get frozen. Therefore, if possible, remain the charging rate at 100%, and preserve the temperature as possible, so as to ensure that the engine can be started up easily in the next day.
2. In areas where the atmospheric temperature is extremely low, please use the battery which can withstand the cold.

## **4.6.2 OPERATIONS TO BE CARRIED OUT AFTER COMPLETION OF WORKS IN EACH DAY**

In order to prevent the mud, water or snow on the loader from getting frozen and ensure that the loader can be used in the next day, be sure to complete the following operations:

1. Thoroughly clear away the mud, water or snow on the loader, and prevent the sealing performance from being damaged because mud, water or snow enters into sealed portion and then gets frozen.
2. Park the loader on a dry and hard ground. If no such a ground is available, park the loader on a wood plank. The use of wood plank may prevent the loader from being frozen to the ground and ensure the normal use in the next day.
3. At low temperature, the capacity of the battery will reduce obviously as the storage time lasts. Be sure to cover the battery, or move it to a warm place and install it onto the loader for working in the next day.

## **4.6.3 AFTER COLD WEATHER HAS ENDED**

After the weather becomes warm as the season changes, please carry out the following works:

1. The semi-sticky fuel, hydraulic oil and lubricating oil shall be used for all parts.

2. If no permanent anti-freezing fluid is used, be sure to fully drain the water in the cooling system, clean up the cooling system, and then fill the new coolant.

## **4.7 OPERATION UNDER SPECIAL CONDITIONS**

### **4.7.1 OPERATION UNDER EXTREMELY COLD CONDITIONS**

If the loader is working in extremely cold weather, protective measures shall be taken to ensure the normal operation. The following detailed inspection can ensure the normal operation of the loader at low temperature.

1. Inspect whether correct anti-freezing agent has been added into the cooling system. Carefully inspect the cooling system, and record the leakage.
2. Keep the battery fully charged so as to prevent it from getting frozen. If water is filled into the battery, be sure to make the engine run for at least one hour, so as to realize the full mixing between water and electrolyte.
3. Maintain the engine at the best state, so as to ensure that it can be started up easily under adverse weather conditions.
4. Select the engine oil of appropriate specification on the basis of the temperature.
5. It shall be ensured that the fuel tank is always filled with fuel. Before operating the loader, discharge condensate from the fuel tank. Maintain and repair the fuel tank filter element, discharge the wax-like condensate, and ensure that the cloud point of the fuel used is lower than the lowest ambient temperature.
6. In accordance with the "Table of Maintenance Interval" as given in this Manual and the lubrication figure printed on the loader, fully lubricate the loader.
7. Start up the engine, and make it reach the normal operating temperature before the commencement of any loaded work.
  - 1) When the engine is running at idle speed, if it is found that there is mud or ice on any moving part, be sure to thaw such mud or ice with heat before the loader is operated.
  - 2) Carefully operate the hydraulic part, until the normal operating temperature is reached.
  - 3) Inspect all control devices of the loader, and ensure that they work normally.
8. Be sure to place a standby external air filter in the cab, so as to facilitate the replacement of any part which is frozen or affects the breathing of engine.
9. Under cold weather, the start aid shall be used. Please refer to the contents of "Startup of Engine" relating to start up under cold weather.
10. In order to prevent freezing situation, clear away all mud, snow and ice. If possible, cover the loader with canvas, and prevent the edge of the canvas from being frozen to the



ground.

## **4.7.2 OPERATION UNDER EXTREMELY HOT WEATHER**

The continuous operation at high temperature may get the loader overheated. If necessary, monitor the temperature of engine and gearbox, and stop the loader so as to cool them down.

1. Inspect and maintain the fan and radiator from time to time. Inspect the level of coolant in the radiator. Inspect whether the dust, sand and insect which may block up the cooling pipeline is accumulated on the radiation fin.
  - ① At high temperature, the generation of scale in the cooling system may be accelerated. The anti-freezing fluid shall be replaced each year, so as to remain its function as a corrosion inhibitor.
  - ② If necessary, clean up the cooling system on a regular basis, so as to ensure that the pipeline is clean and clear. Don't use the water which is excessively alkaline, otherwise the scale and rust may appear more easily.
2. Inspect the level of electrolyte every day. Maintain the electrolyte at an appropriate level, so as to prevent the battery from getting damaged. At high temperature, please use weaker electrolyte. Dilute the electrolyte of which the specific gravity is 1.280 until the specific gravity is lowered to 1.200-1.240, and fully charge the battery. Whenever the specific gravity reduces to 1.160, be sure to re-charge the battery. If being placed at high temperature for long time, the battery may automatically discharge its electricity at a relatively high rate. If the loader will be parked for several days, please detach the battery and place it in a cool place.

**NOTE: Don't place acid battery near a lot of tires, for the acidic gas may harm rubber.**

3. Maintain and repair the fuel system in accordance with the Section "Engine Fuel System" in this Manual. Before filling the fuel, inspect the level of fuel in the fuel tank. Both high and low temperature can cause the concentration of materials in the fuel tank.
4. Carry out lubrication in accordance with the "Table of Periodic Maintenance" or the lubrication sign on the loader.
5. Don't park the loader under sunshine for long time. Park the loader under the covering material, so as to prevent sunshine, dirt and dust.
  - ① If no appropriate covering material is available, please cover the loader with canvas. Be sure to prevent dust from entering into engine, gearbox or hydraulic system.
  - ② Under the high temperature and high humidity, all parts of the loader may get corroded, and they may get corroded easily in rainy days. Rust and pocket may appear on metal surface, and spots may appear on the surface of other parts.

- ③ Apply the anti-corrosion lubricating oil onto the unpainted or exposed surfaces. Use insulating compound to protect wires and terminates. On the damaged surfaces, use paint or appropriate antirust agent to prevent rust or corrosion.

### **4.7.3 OPERATION IN DUSTY OR SANDY AREA**

1. In most areas, the loader may generate dust in the course of work. However, when the loader is used in a place where there is a lot of dust and sand, protective measures shall be taken.
2. Keep the cooling system and cooling areas clean, clean them up with compressed air, and take this measure as frequently as possible.

#### **WARNING: When using the compressed air, please wear the safety goggles**

1. When maintaining or repairing the fuel system, be careful so as to prevent dust and sand from getting into the fuel pipeline.
2. Maintain the air filter from time to time, inspect the air control indicator every day, and keep the dust cover and dust valve clean. Try best to prevent dust and sand from entering into any part of engine.
3. Lubricate the loader in accordance with the lubrication sign and lubrication interval table on the loader. Before carry out the lubrication, clean up all lubrication nipples, because the sand in the lubricating oil may cause the wear and accelerated wear of parts.
4. Keep the loader as clean as possible. Park the loader under canopy or cover it with tarpaulin, so as to protect the loader against the corrosion caused by wind and sand.

### **4.7.4 OPERATION IN RAINY AND HUMID ENVIRONMENT**

The precautions for operation in rainy environment are similar with those for operation under high temperature conditions.

Apply lubricating oil onto all exposed surfaces, especially damaged and unpainted surfaces. Apply lubricating oil onto the location where the paint is damaged as soon as possible, so as to prevent corrosion.

### **4.7.5 OPERATION IN SALT WATER**

Salt water and sea water is highly corrosive. When operating the loader in salt water, please pay special attention to the following matters:

1. After the loader is stained with salt water, immediately wash it with fresh water and then dry it up.
2. Apply anti-corrosion lubricating oil onto all surfaces which contact with salt water, especially those surfaces where the paint is damaged.

3. Repair the damaged paint in time.
4. Lubricate the loader in accordance with the lubrication sign and lubrication interval table on the loader. As for the loader working in salt water, the lubrication interval shall be shortened appropriately.

#### **4.7.6 OPERATION AT HIGH ALTITUDE**

Under normal conditions, the precautions for operation at high altitude are the same as those for operation at low temperature. Before operating the loader at high altitude, be sure to adjust the mixing ratio of fuel and air in accordance with the relevant engine manual.

Measure the operating temperature of the engine, and inspect whether the engine is overheated. The cover of radiator shall be properly sealed, so as to prevent the pressure of the coolant from being released.

# CHAPTER V MAINTENANCE AND REPAIR

## 5.1 PREPARATION BEFORE MAINTENANCE

Follow with the "Maintenance and Security Matters" mentioned in the previous chapter

## 5.2 REGULAR MAINTENANCE

### Instructions:

1. Before any operation or maintenance, make sure the instruction manual of the machine concerning safety, warning and descriptive information has been read and understood completely.
2. The user is responsible for proper maintenance of the machine, including adjusting mechanism, adding lubricants and other operating fluids, replacing filters and replacing parts due to normal wear or aging. Failure to maintain the entire machine according to correct intervals and specified procedures may lead to a drop in performance to the machine as well as accelerated wear on its parts and components.

### Note:

- 1) Before any continuous maintenance cycle, it is necessary to complete all previous maintenance work firstly. In completing any item of maintenance work, it is necessary to ensure that any other items that are supposed to be performed according to cycles shorter than its cycle are done simultaneously with that item of work. For example, if a collection of items of work supposed to be performed once every 500 hours or every three months needs to be done, some other items must be performed simultaneously, including any item supposed to be performed once every 250 hours or every month, once every 100 hours or half a month, once every 50 hours or every week, or once every 10 hours or every day.
- 2) It is imperative that all maintenance cycles be determined by work time. However, calendar time-based cycles could replace work time-based ones if calendar time-based maintenance plans turn out to be more convenient and the numbers included in calendar time-based plans are approximate to those in the corresponding work time-based plans. Carry out maintenance work, no matter what time is adopted, work time or calendar time, whichever comes first;
- 3) It is necessary to shorten time specified in the maintenance cycles table and carry out maintenance more frequently under the extremely harsh, dusty, wet, or other unfavorable working conditions.

### I. Routine maintenance items to be performed once every 10 hours or once a day

1. Check the engine coolant and make sure that the engine has been filled to the full; If the machine equipped with attached tank, check the coolant level whether in the normal range or not, add coolant as necessary.
2. Check the engine oil level of engine and the liquid level of injection pump governor, and ensure the level stays within the normal operating range, add it as necessary.
3. Check the hydraulic oil level in the hydraulic tank to ensure that the level stays within the normal operating range, add it as necessary.

4. Check the oil level of the transmission to ensure that the level stays within the normal operating range, add it as necessary.
5. Check the fuel whether it is enough or not, add it if necessary.
6. Check the air filter of engine whether it is clean or not, replace it if necessary.
7. Drain all air reservoirs for pneumatic brake machines; but not for hydraulic brake machines;
8. Add lubricating grease to all articulated points, pin shaft sleeves and other positions according to the lubrication schematic diagram of the machine;
9. Check and make sure air pressure of tires is normal and no abnormal wear exists; check all hydraulic components and hydraulic pipes whether spilled oil or existing abnormal wear.
10. Check and make sure all systems could not spill oil, water and air. Visually inspect and make sure engine fan and driving belt no loosening or damage.
11. Check the fixed bolts and nuts on the engine, transmission, drive axle, and rims to ensure that no loosening; inspect the bucket teeth and the knife plate, and replace them as necessary;
12. Check and ensure the start-up performance of the diesel engine, the color of its exhaust, and the sound of the engine are normal; after observing the machine while it operates for ten minutes, inspect whether any alarm of abnormal sound or overheating exist or not.
13. Check and make sure the following parts of the machine work normally: dashboard, lights, seat belt, reversing alarm system, generator, brake system and steering system. At the same time, ensure that all switches, quick couplers, operating levers, pedals, operating handles, buttons and others elements of the machines can be operated normally.

## **II. Maintenance items to be performed once every 50 hours or every week**

1. Drain the strainer (oil-water separator) of the engine fuel system;
2. Check and add the brake-fluid of the machine. (Note: A brake-fluid of the same model as the original fluid must be used. Otherwise, the original fluid must be completely emptied through a port near the brake caliper and add a new brake-fluid);
3. Check the oil level of the final reducer at each end of the drive axle, and the oil level of the main drive in the center of the axle housing; add oil as necessary (Note: Oil of the same model as the original oil must be used; Otherwise, the service life of the oil will be affected.)
4. Start the machine, and after finishing one to two operating cycles, lower the arm to the ground and then stop the engine, inspect the oil levels in the hydraulic oil tank and the transmission and replenish the tanks as necessary (Note: Oil of the same model as the original oil must be used; otherwise, the service life of the oil will be affected);
5. Check the gap between any brake pad and the matching brake disk and make replacements as necessary; Tighten the fixed bolts and nuts on all transmission shafts to ensure that no loose bolt or nut exists;
6. Carry out the following operations if these 50-hour maintenance items are performed on the machine for the first time, or skip it: replace the engine oil, engine oil filter and diesel oil filter elements.

### **III. Maintenance items to be performed once every 100 hours or every half a month**

1. Remove foreign matters from all air-cooled radiator surface of the machine to ensure that the cooling system can operate normally;
2. Carry out the following operations if these 100-hour items are performed on the machine for the first time, or skip it: replace the transmission oil, the oil filters of the transmission and torque converter and the outer oil filter of transmission and torque converter; (the filter is optional, not for all machines) open the bottom cover of the transmission; clean the filter net and the magnet carefully and then put them back in place.

### **IV. Maintenance items to be performed once every 250 hours or every month**

1. Check the air intake system of the engine. Visually check the service indicator of the air filter. Clean or replace the filter element of the air filter if the yellow piston of the indicator rises into the red region;
2. Replace the engine oil, the engine oil filter, the fuel oil filter and the oil-water separator filter element.(the filter is optional, not for all machines)
3. Adjust the tension of the driving pulley of the engine and the air conditioning compressor belt and the generator belt, check the damaged condition and replace it if necessary. Tighten all bolts fixed the battery and clean its top;
4. Check the implement, weld seam of the front and rear parts of the frame and fixed bolts whether they have cracks or loosening.
5. Carry out the following operations if these 250-hour items are performed on the machine for the first time, or skip it: collect and filter the working hydraulic oil, replace the oil intake filter element, replace the return oil filter element for the working hydraulic oil, clean the inside of the hydraulic oil tank, return the filtered hydraulic oil to the hydraulic oil tank, and replenish the hydraulic oil tank as necessary to ensure an appropriate oil level in the tank; (Note: When replacing the hydraulic oil filter element, the original hydraulic oil must be filtered or replaced).

### **V. Maintenance items to be performed once every 500 hours or every three months**

1. Tighten the bolts for connecting the front/rear axle and the frames, and the plate bolts for articulating the front and rear parts of the frame. Check the structure, hood and cab of the machine whether they are damaged, repair them as necessary.
2. Check and eliminate the water and impurities in the diesel tank, clean the oil filter and respirator; check and adjust the engine air valve.
3. Check the brake pads and disks and replace them if any brake pad is less than 2/3 thick and any damaging brake disk;
4. Collect and filter the working hydraulic oil, replace the oil intake filter element of the hydraulic oil tank, clean the hydraulic oil tank, return the filtered hydraulic oil to the hydraulic oil tank, and replenish the hydraulic oil tank as necessary to ensure an appropriate oil level in the tank; (Note: When replacing the hydraulic oil filter element, the original hydraulic oil must be filtered or replaced)
5. Replace the oil in the transmission, the oil filters of the transmission and torque converter and the outer oil filter of transmission and torque converter (the filter is optional, not for all machines); open the bottom cover of the transmission, clean the filter net and the magnet carefully, and then put them back in place;
6. Replace the oil for the final reducer at both ends of the drive axle, as well as the oil for th

the main drive in the center of the axle housing; replace all the drive axle gear oil once each year even if the total number of work hours is less than 500.

**VI. Maintenance items to be performed once every 1000 hours or every half a year**

1. Replace the hydraulic oil, the return oil filter element of hydraulic oil, and the oil suction filter element of hydraulic oil, and clean the hydraulic oil tank;
2. Clean the diesel tank and replace the oil suction filter element of diesel tank and the inner filter element of the engine.
3. Check ROPS (it is optional, replace it based on the model);
4. Replace the dryer of the brake system; (it is optional, replace it based on the model)

**VII. Maintenance items to be performed once every 2000 hours or every year**

1. Replace the coolant of the engine.
2. Check the differentials of the front and rear axles and wheel hub reducer and repair them if necessary.

**VIII. Maintenance items to be performed once every 4000 hours or every two years**

1. Check the performance of the engine and replace the hose of fuel system of the engine.
2. Check the airtightness of the distribution valve and working cylinder and repair or replace them if necessary.
3. Check the working condition of torque converter and transmission, repair them if necessary.

**IX. Maintenance item to be performed once every 6000 hours or every three years.**

Check the high pressure oil pipes and sealing elements of hydraulic system and replace them if necessary.

**X. Maintenance item to be performed once every 10000 hours or every five years.**

Check the transmission and drive axles, dismantle and repair them if necessary.

Note:

1. The steering bearings of the front and rear parts of the frame need to be checked after working 5000 hours and replace it if any abnormal sound exists.
2. The seat belt needs to be replaced once three years after the date of manufacture or 6000 hours after the date of operating (whichever comes first);

**Attachment 1**

Machine No.:

**Registration Table for Phase-by-phase Checking and Maintenance of the Loader  
(No.1)**

Work time	50h	100h	250h	500h	1000h	2000h	4000h	6000h	10000h	Check date	Checked by	Brief defect description
50h	•											
100h	•	•										
150h	•											
200h	•	•										
250h	•		•									
300h	•	•										
350h	•											
400h	•	•										
450h	•											
500h	•	•	•	•								
550h	•											
600h	•	•										
650h	•											
700h	•	•										
750h	•		•									
800h	•	•										
850h	•											
900h	•	•										
950h	•											
1000h	•	•	•	•	•							
1050h	•											
1100h	•	•										
1150h	•											
1200h	•	•										
1250h	•		•									
1300h	•	•										
1350h	•											
1400h	•	•										
1450h	•											
1500h	•	•	•	•								
1550h	•											
1600h	•	•										
1650h	•											
1700h	•	•										
1750h	•		•									
1800h	•	•										
1850h	•											
1900h	•	•										
1950h	•											
2000h	•	•	•	•	•	•						
2050h	•											
2100h	•	•										
2150h	•											
2200h	•	•										



**Attachment 1**

Machine No.:

**Registration Table for Phase-by-phase Checking and Maintenance of the Loader  
(No.2)**

Work time	50h	100h	250h	500h	1000h	2000h	4000h	6000h	10000h	Check date	Checked by	Brief defect description
2250h	•		•									
2300h	•	•										
2350h	•											
2400h	•	•										
2450h	•											
2500h	•	•	•	•								
2550h	•											
2600h	•	•										
2650h	•											
2700h	•	•										
2750h	•		•									
2800h	•	•										
2850h	•											
2900h	•	•										
2950h	•											
3000h	•	•	•	•	•							
3050h	•											
3100h	•	•										
3150h	•											
3200h	•	•										
3250h	•		•									
3300h	•	•										
3350h	•											
3400h	•	•										
3450h	•											
3500h	•	•	•	•								
3550h	•											
3600h	•	•										
3650h	•											
3700h	•	•										
3750h	•		•									
3800h	•	•										
3850h	•											
3900h	•	•										
3950h	•											
4000h	•	•	•	•	•	•	•	•				
4050h	•											
4100h	•	•										
4150h	•											

**Attachment 1**

Machine No.:

**Registration Table for Phase-by-phase Checking and Maintenance of the Loader  
(No.3)**

Work time	50h	100h	250h	500h	1000h	2000h	4000h	6000h	10000h	Check date	Checked by	Brief defect description
4200h	•	•										
4250h	•		•									
4300h	•	•										
4350h	•											
4400h	•	•										
4450h	•											
4500h	•	•	•	•								
4550h	•											
4600h	•	•										
4650h	•											
4700h	•	•										
4750h	•											
4800h	•	•										
4850h	•											
4900h	•	•										
4950h	•											
5000h	•	•	•	•	•							
5050h	•											
5100h	•	•										
5150h	•											
5200h	•	•										
5250h	•		•									
5300h	•	•										
5350h	•											
5400h	•	•										
5450h	•											
5500h	•	•	•	•								
5550h	•											
5600h	•	•										
5650h	•											
5700h	•	•										
5750h	•		•									
5800h	•	•										
5850h	•											
5900h	•	•										
5950h	•											
6000h	•	•	•	•	•	•		•				
6050h	•											
6100h	•	•										

**Attachment 1**

Machine No.:

**Registration Table for Phase-by-phase Checking and Maintenance of the Loader(No.4)**

Work time	50h	100h	250h	500h	1000h	2000h	4000h	6000h	10000h	Check date	Checked by	Brief defect description
6150h	•											
6200h	•	•										
6250h	•		•									
6300h	•	•										
6350h	•											
6400h	•	•										
6450h	•											
6500h	•	•	•	•								
6550h	•											
6600h	•	•										
6650h	•											
6700h	•	•										
6750h	•		•									
6800h	•	•										
6850h	•											
6900h	•	•										
6950h	•											
7000h	•	•	•	•	•							
7050h	•											
7100h	•	•										
7150h	•											
7200h	•	•										
7250h	•		•									
7300h	•	•										
7350h	•											
7400h	•	•										
7450h	•											
7500h	•	•	•	•								
7550h	•											
7600h	•	•										
7650h	•											
7700h	•	•										
7750h	•		•									
7800h	•	•										
7850h	•											
7900h	•	•										
7950h	•											
8000h	•	•	•	•	•	•						
8050h	•											

**Attachment 1**

Machine No.:

**Registration Table for Phase-by-phase Checking and Maintenance of the Loader  
(No.5)**

Work time	50h	100h	250h	500h	1000h	2000h	4000h	6000h	10000h	Check date	Checked by	Brief defect description
8100h	•	•										
8150h	•											
8200h	•	•										
8250h	•		•									
8300h	•	•										
8350h	•											
8400h	•	•										
8450h	•											
8500h	•	•	•	•								
8550h	•											
8600h	•	•										
8650h	•											
8700h	•	•										
8750h	•		•									
8800h	•	•										
8850h	•											
8900h	•	•										
8950h	•											
9000h	•	•	•	•	•							
9050h	•											
9100h	•	•										
9150h	•											
9200h	•	•										
9250h	•		•									
9300h	•	•										
9350h	•											
9400h	•	•										
9450h	•											
9500h	•	•	•	•								
9550h	•											
9600h	•	•										
9650h	•											
9700h	•	•										
9750h	•		•									
9800h	•	•										
9850h	•											
9900h	•	•										
9950h	•											
10000h	•	•	•	•	•	•			•			





## 5.4 THE CHINESE AND FOREIGN OIL TYPE LIST FOR WHEEL LOADER

NO.	Oil Name		Chinese standard serial number and type	International standard serial number and type
1	Oil for Engine	Engine Oil	Ordinary CD 15W/40	Ordinary CF-4 15W/40
			LOW temperature CD 5W/40 or CD OW/40	LOW temperature CF-4 5W/30
		Diesel Oil	Ordinary 0#	Ordinary 0#
			LOW temperature-35# or -50#	LOW temperature-35# or -50#
2	Oil for DF Cummins Engine	Engine Oil	Ordinary CH-4/SJ 15W/40	Ordinary VCH-4/SJ 15W/40
			LOW temperature CH-4/SJ 5W/40 or CH-4/SJ OW/40	LOW temperature CH-4/SJ 5W/40 or CH-4/SJ OW/40
		Diesel Oil	Ordinary 0#	Ordinary 0#
			LOW temperature-35# or -50#	LOW temperature-35# or -50#
3	Hydrodynamic Transmission Oils		Ordinary(LOW temperature) 8D N46D Ordinary)8# N46、	PTF-2 1.GM company's Track-coach PTF-2 2.Allison company's C-3,C-4,C-5 3.Caterpillar company's TO-3,TO-4 4.Mobil company's ATF220 5.BP company's Hydraulic TFCZ 6.Shell company's Rotella 10W

		JARNC-4 which was developed by Xi'an Petroleum University Jiarun Industry and PTF-2 have the same quality 6#(n32)= PTF-2 8#(n46)= PTF-1 N68#(Anti-wear hydrodynamic transmission oils)= PTF-3	PTF-3 1. John-Deer company's J-20B, J-14B, JDT-303 2. Ford company's M2C41A, MIC86A, MIC134A 3. Massay-Ferguson company's M-1135, M-1127A
4	Gear Oil	Ordinary LS-90	Ordinary API GL-5 SAE90 (Recommend Mobil GX90)
		Low temperature LS-80W-90	Low temperature API GL-5 SAE80W-90 (Recommend Mobil GX80W-90)
5	Hydraulic Oil	Ordinary L-HM46#	Ordinary Mobil DTE 15M
		Low temperature L-HV46# or L-HS46#	Low temperature Mobil DTE FM46
6	Lubricating Grease	Ordinary 2# Lithium saponify	Ordinary 2# Lithium saponify
		Centralized lubricating 1# Extreme pressure lithium saponify	Centralized lubricating Mobil EP1
7	Brake Fluid	XILIAN 719#	Mobil DOT3
8	Air Conditioning Refrigerants	R134a	R134a



## 5.5 OIL INFORMATION

In the large scale of -30 to 50 Celsius, grade, provision and addition in each small range for the recommended engine oil, transmission oil, hydraulic oil, drive axle oil, pin shaft lubrication grease, diesel oil, antifreeze.(with international grade and metric unit).

Type	Environment temperature										Capacity
	-30	-20	-10	0	10	20	30	40	50		Filling quantity
Engine oil	API CF-4 and higher										20L
	SAE 10W-30										
	SAE 15W-40										
Hydraulic transmission oil	SAE 5W-40										45L
	SAE 10W										
Hydraulic oil	L-HM46										270L/ 275L(three-link)
	L-HV46										
Drive axle gear oil	SAE 85W-90										56L
	SAE 85W-90										
Lubrication grease	NO.2										2kg
Diesel oil	0#										265
	-10#										265

## 5.6 UNIVERSAL TORQUE TABLE

Unless otherwise stated, the screw used in the machines should be tightened according to the following table.

Universal torque table of metric thread		
Specifications	Tightening torque (N.M)	
	8.8 class	10.9 class
M6	9~12	13~16
M8	22~30	30~36
M10	45~59	65~78
M12	78~104	110~130
M14	124~165	180~210
M16	193~257	280~330
M18	264~354	380~450
M20	376~502	540~650
M22	512~683	740~880
M24	651~868	940~1120
M27	952~1269	1400~1650
M30	1293~1723	1700~2000
M33	1759~2345	2743~3298
M36	2259~3012	2800~3350
M39	2932~3898	4111~5481

Torque table of the thread inserts smeared with sealants	
Pipe Thread Size Code	Tightening torque (N.M)
3/8	15±2
3/4	24±4
1/2	23±3
1	45±4

## 5.7 MAINTENANCE OF THE ENGINE COOLANT

The engine cooling system has great influence on the performance, reliability and durability of the overall engine. Therefore to properly maintain the engine cooling system

is extremely important, the engine overheat and over-cold, piston and piston ring and cylinder liner are locked dead, thermal fatigue crack occurs on the cylinder head, lubricants quickly degenerate, spot eroded, air eroded and others faults are common failures in the cooling system, they will not only cause the overall deterioration of power, economical efficiency, reliability and durability of the engine, but also cause serious damage to the engine.

### 5.7.1 COOLANT COMPOSITION

The coolant of the engine is composed and with water, antifreeze liquid and additives in certain proportion.

LONKING recommends using the mixture of 50% ethylene glycol or propylene glycol-based antifreeze and 50% soft water as the coolant of the engine in most weather conditions.

#### ① Water used in the coolant

The water used in the coolant must be soft water (distilled water is preferable), and prohibit to use the untreated water as the coolant of the engine. Hard water or the water containing with calcium and manganese ions with a high rate is apt to produce water-insoluble compounds and prone to generate furring in the water jacket of the engine, causes blocking waterways, heat transfer hindered, and results in engine overheating; while the water containing higher rate of sulfate or chloride-containing will be corrosive.

#### ② Anti-freeze fluid

Antifreeze has the double features of antifreeze and anti-boiling, has anti-corrosion and other functions as well. Therefore, when the engine is working at a relatively low temperature, the antifreeze should be used in order to prevent the water freezing in the cooling system of the engine, to avoid the engine overheating due to the termination of cooling water circulating, or to keep the body, cylinder cover and heat radiator from expanding and cracks as the water freezes with the expanded volume. Along with the mass ratio increasing in the antifreeze coolant, the boiling point of coolant increases, the freezing point lowers. The antifreeze concentration should not exceed 68.1% (the freezing point is of  $-68^{\circ}\text{C}$ ), otherwise the performance will be worsened: the freezing point of coolant will rise instead, and it is easy to form a gel. The normal concentration range is of 40% to 60%, 50% of the concentration of antifreeze cooling fluid is recommended, at the moment, the freezing point of the coolant is of  $-35.5^{\circ}\text{C}$ , while the boiling point at atmospheric pressure is of under  $103^{\circ}\text{C}$ , the boiling point in the cooling system is of about  $110^{\circ}\text{C}$ .



**As antifreeze is flammable, do not close to the naked fire.**

#### ③ Additives

Usually the additives contain anti-rust agent, foam suppressing agent, coloring agents etc.

The anti-rust agent can delay or prevent the engine water jacket wall and the radiator from rusting or corrosion. The air in the coolant will produce a lot of bubbles under the stirring of the blades of the water pump, these bubbles will hinder the cooling water jacket wall from heat radiating. The foam suppressing agent can effectively inhibit the generation of the bubble. Coloring agent normally makes the coolant presenting blue-green or yellow for identification. In the process of engine operation, the additive will gradually deplete. Therefore, it is quite necessary to replace the cooling liquid periodically.

Therefore, the normal maintenance of the engine coolant not only functions as good anti-rust, anti-corrosion, furring generation to a variety of metals within the cooling system, but also effectively reduces the cavitations erosion (cavitations erosion is a kind of damage phenomenon of the fluid engineering, and the outer wall of diesel engine cylinder liner will also produce metal falling off resulting from cavitations corrosion, and will gradually form a honeycomb-like with different diameter sizes, and is damaged finally).

**Warning**

- 1. When the temperature is below 0 °C , it is necessary to inspect the coolant concentration regularly.**
- 2. As for the region where the engine is operating above 0 °C year around, the water via anti-rust, and anti-furring treatment can be used as coolant, and it is forbidden to use untreated water as the engine coolant.**

**5.7.2 ADDING COOLANT**

- The new machine or the engine after cleaning the cooling system requests to add coolant, or in case of adding coolant due to weather conditions, the freezing point of the coolant to be chosen should be at least 5 °C lower than the local minimum temperature.

The total volume of engine cooling system is of about 48L, while the water inlet room of the heat radiator in the cooling system should contain 6% of the total volume as expansion volume and at least 11% of the total volume of reserving water. See right figure:

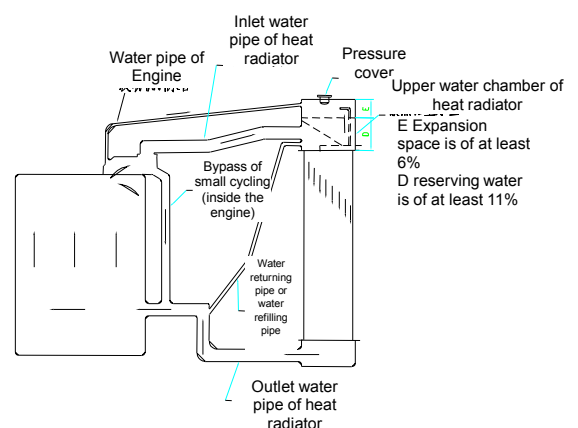

In fact, the volume of antifreeze of the cooling system requires is about 45L or so (to be confirmed that the coolant in the previous cooling system, including heating section of the air-conditioning system has been exhausted).

1. Manually switch on the negative pole switch of battery, and insert the key into a starter switch and rotate in clockwise direction to switch to shift one to turn on the whole vehicle power, switch on the heating function of the air-conditioning system.
2. Switch on with counter-clockwise rotation the water valve of the two heaters of the inlet and outlet water pipe of the evaporator from the engine to air conditioner system.

Warm water valve for controlling the water inlet of the air-conditioning system, see right figure:

3. Open the pressure cap on the top of heat radiator, and slowly fill the coolant, and the filling rate should be maintained at 19L/min, and to ensure a fill rate of over 90% of the total volume at one time.
4. After the coolant level is stable, start the engine with the pressure cover open, run 25 minutes in total at low, high and idle speed, ensure coolant temperature reaches 82 °C and above, to remove the air accumulated in the cooling system when filling in at the first time.
5. Inspect the coolant level of the heat radiator, add coolant to the appropriate position (6% expansion space need to be reserved).

Tighten the pressure cap of the heat radiator.



### **5.7.3 INSPECT COOLANT LEVEL REGULARLY**

Heat radiator is located at the tail of the machine.

Water inlet of heat radiator, see right figure:



1. Slowly uncap the pressure cap at the upper section of the heat radiator, and gradually release the pressure.

**⚠ Warning**

**Under thermo-mechanical state, do not immediately open the heat radiator pressure cap, to avoid the high-temperature coolant or steam damaging the skin, gradually open or wait until the coolant temperature drops down to about 50°C and then open it.**

2. Maintain the coolant in the right position (6% the expansion space need to reserved), add coolant, if necessary.

**⚠ Warning**

**Adding coolant when the engine is at high temperature will cause coolant boiling and damages to the engine. Fatherly fill coolant till the coolant temperature is below 50°C.**

3. Tighten the heat radiator pressure cap.

#### **5.7.4 CLEANING OF COOLING SYSTEM**

The machine takes 4800 hours running or two years (whichever occurs first) as a cycle, and it requests to replace coolant and clean up the cooling system.

Prior to that, if the coolant is contaminated, and the engine is overheating, corrosion or bubble occurred in the cooling system, it is necessary to clean the cooling system in advance and replace coolant.

- Manually switch on the negative pole switch of the battery, insert the key in starter switch and turn with clockwise rotation to switch on the power of the whole vehicle, and turn on the warm function of the conditioning air-system.
- Turn on the water valve of the two heater of the inlet and outlet water pipe of the evaporator from the engine to the air-conditioning system with counter-clockwise rotation.
- Start the engine, turn off after 5 minutes idle operation, then switch on again, slowly turn off the pressure cap of the heat radiator to release pressure till the coolant temperature is below 50°C.
- Open the outlet valve at the bottom of the heat radiator, drain out the engine coolant.

**⚠ Warning**

**As the engine coolant is toxic, do not drink or casually discard.**

5. After drain out the engine coolant, turn off the outlet valve at the bottom of heat radiator, see right figure:



6. Re-fill soft water into the engine and add proper amount of special cleaning agent with the same filling method as that of the coolant.
7. Repeat the above steps 4, 5, and 6 till the cleaning liquid is discharged without too much dirt.
8. Fill the coolant with the method specified for adding coolant.

### **5.7.5 ENGINE AIR FILTER MAINTENANCE**

When the Engine is working, it demands clean and fresh air from filter, and proper maintenance protects the cylinder liner, piston, piston rings, valves and other parts of from wearing and reduces the wearing. Air filter can also reduce the intake noise.

**⚠ Warning**

- 1. Air filter must be replaced when the filter element is broken.**
- 2. In case of maintenance, do not pollute the internal side of the filter element.**
- 3. Do not drive the loader without air filter element or air filter.**

### **5.6.5 ENGINE AIR FILTER MAINTENANCE**

When the Engine is working, it demands clean and fresh air from filter, and proper maintenance protects the cylinder liner, piston, piston rings, valves and other parts of from wearing and reduces the wearing. Air filter can also reduce the intake noise.

**⚠ Warning**

- 1. Air filter must be replaced when the filter element is broken.**
- 2. In case of maintenance, do not pollute the internal side of the filter element.**
- 3. Do not drive the loader without air filter element or air filter.**

### **5.6.6 MAINTENANCE AND REPLACEMENT OF THE AIR FILTER ELEMENT**

Set pressure drop alarm indicator connector at the outlet of the air filter, the yellow piston of the air filter indicator moves to the red area when the engine is running in high idle speed. The air filter needs maintenance.

Air filter alarm indicator is shown in the right figure:



1. Shut down the engine, and remove the air filter cover.

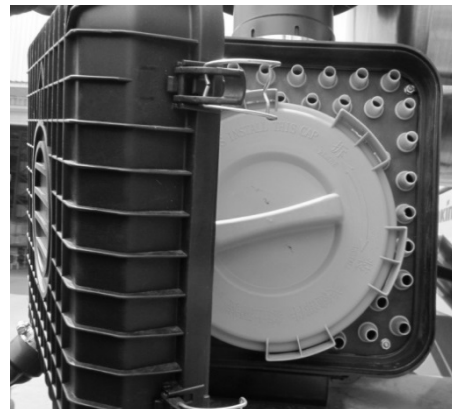

2. Unscrew the filter cover in arrow direction.

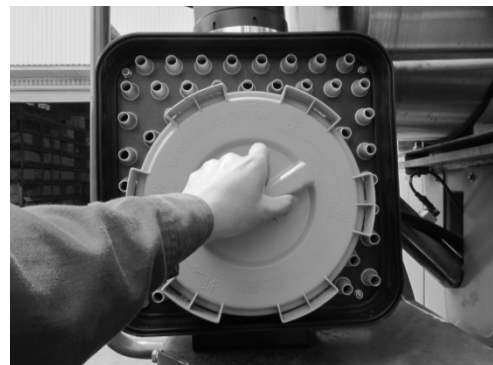



3. Remove coarse filter.



4. Remove fine filter.

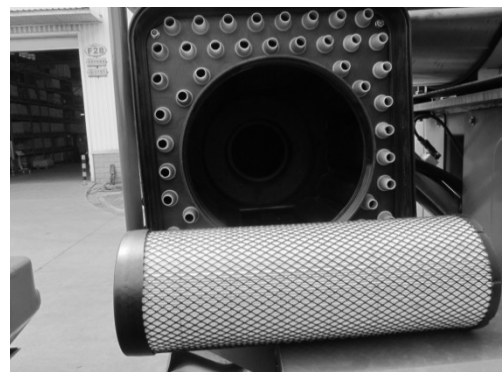

5. Blow away the dust on the filter paper of coarse filter with compressed air free of oil mist, water (pressure less than 300KPa). (After coarse filter is cleaned five times, it is needed to replace air fine filter and cleaned fine filter shall not be used again.)

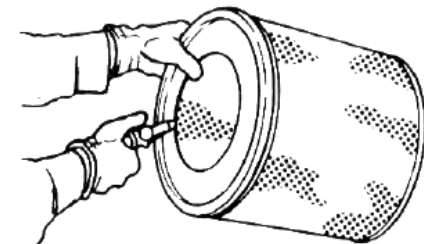

6. Inspect coarse filter with electric lamp after cleaning it. If any small hole or tiny article is

found over it or gasket or seal is damaged, replace it with a new coarse filter.

7. Install the clean coarse filter into the air filter shell to ensure the even contact of the sealing part at the end of the coarse filter.
8. Clean and install the cover of air filter, tighten the cover with hand and fasten the end cover.
9. Press the indicator to reset the indicator.

If the engine starts, the yellow piston of air filter indicator moves to the red area, or the engine produces black smoke, with power dropping down, it requires replacing with a new coarse filter. Inspect the air filter maintenance indicating lamp or at any time, clean the coarse filter regularly (when the indicating lamp lights up) and replace (every 1000 hours). If the working environment and areas are very harsh, then the cleaning and replacement cycle are shortened, depending on the situation.

### **5.6.7 CLEAN DUST COLLECTION CUP OF THE AIR FILTER**

Dust collection cup is for collecting the dust and water inside the air filter, press the dust cup regularly, and drain out the water and dust.



1. **When the air filter element is broken, it must be replaced.**
2. **Conduct the maintenance on air filter periodically according to the requirement of the air filter maintenance instructions.**
3. **In case of maintenance, do not pollute the internal side of the filter.**
4. **Do not start the engine with air filter or air filter element disassembled.**

## **5.8 USE OF FUEL SYSTEM AND RELATED MAINTENANCE**

### **5.8.1 FUEL TANK CLEANING**

Removal of moisture and impurities from fuel:

1. If conditions permit, diesel shall be allowed to settle for 24 hours before being filled into fuel tank.
  2. Before oil filling, unscrew the drain plug on the bottom of fuel tank once every week to remove moisture and impurities at the bottom of fuel tank.
  3. After end of daily work, fill up the fuel tank with diesel to remove moisture from fuel tank.
  4. After each filling up of fuel tank, keep still for 5~10 minutes so that moisture and impurities in diesel will settle at the bottom of fuel tank.
  5. After end of daily work, unscrew the drain plug at the bottom of diesel pre-filter, primary diesel filter and secondary diesel filter to remove moisture and impurities.
- Repeat the above steps till the drained oil is clean.

## **5.8.2 FUEL OIL LEVEL INSPECTION**

1. Drive the loader to the even site, turn off the engine.
2. Turn the key clockwise and switch to shift one, and power on the whole car.
3. Inspect the amount of instruments on stage fuel table instructions.
4. Inspect the elongated oil level of the fuel tank.
5. If the fuel level is below the center of the min. limit of the level line of the oil (about 20L), you need to add fuel. And observe it at any time to ensure that the fuel level will not lower than the center line of the oil min. Level.

## **5.8.3 APPLICATION AND REPLACEMENT OF FUEL FILTERS**

Engine fuel filter can filter out impurities and particles in the fuel in order to reduce the wear of the precision coupling of the fuel pump and injector. After fuel is filtered, the dirt will be kept at the outer surface of filter. As the filter element is made of diesel filter paper, therefore, it requires regular maintenance and replacement. The replacement cycle is every 500 hours running of the engine.

Fuel filters should be replaced according to the following steps:

1. Firstly clean the fuel filter (coarse filter and fine filter), and clean the install seat.
2. Dismount the fuel filter from the install seat with a belt wrench.
3. Remove the seat gasket on the screw connector of the install seat. Clean the sealing surface of install seat with the non-fiber cloth.
4. Install a new gasket to the threaded connector of the install seat of the fuel filter; smear a layer of engine oil over the sealing surface of the engine; fill the oil filter with full clean diesel.
5. Screw the oil filter on the install seat by hand, after the gasket contacts with the install seat, tighten it with from semi-circle to 3 / 4 circle. In order to prevent the damage of filter, do not over-tighten the oil filter with mechanical method.

## **5.8.4 APPLICATION AND REPLACEMENT OF FUEL PRE-FILTERS**

The function of the pre-filter is basically same as that of the filter. The only difference is that the accuracy of the pre-filter is slightly lower as 10 $\mu$ m (filter accuracy is of 7 $\mu$ m), and the pre-filter has a water cup to discharge the water and impurities in the fuel system. Pre-filter replacement cycle is same as that of the filter.

Fuel pre-filter is to be replaced according to the following steps:

1. Clean the area nearby the install seat of the fuel pre-filter.
2. Dismount the fuel pre-filter from the install seat, and clean the seal surface of the install seat of with non-fiber cloth.
3. Dismount the transparent drainage cup from the lower part of the fuel pre-filter.
4. Clean up the water drain cup, and replace new seal ring, and then install it into a new fuel filter element of the fuel pre-filter.
5. Fill the fuel into the pre-filter, replace new seals, and smear a layer of engine oil over

the engine, and then install it to the install seat.

## 5.8.5 MAINTENANCE OF ENGINE OIL

Inspect the oil level of engine oil

1. Park the loader to even field, turn off engine and rotate the parking brake button to reset.
2. After engine turns off, 10 minutes later, so that the oil in the engine crankcase to flow back into the engine oil pan.
3. Open the hood, the engine oil level and refueling port are all at the right side of the in the engine.

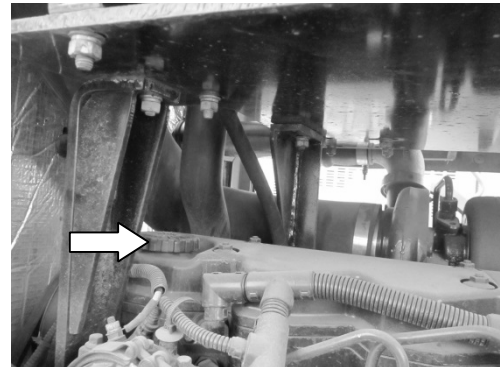

4. Unscrew and pull out the oil level meter, clean the oil level meter with a clean cloth, re-insert it into the engine oil level port till the end, then pull out to inspect the oil level again, the oil level should be located between the "L" scale and "H" of the scale.

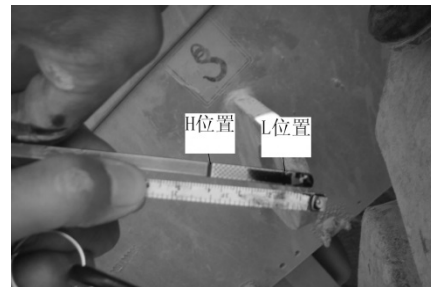

5. If the oil level is below the "L" scale, please add oil; if the oil level is above the "H" scale, please loosen the release screw piston at the bottom of the oil pan to release some oil.

 **Warning**

**Too much engine oil and too little engine will all apt to damage the engine.**

## 5.8.6 REPLACEMENT OF ENGINE OIL

1. When getting up to the required oil change cycle, it requests to replace the engine oil. Park the machine on the flat playground, and start the engine till the water temperature reaches to 60°C, the engine turns off. Rotate the parking brake button to reset. Remove the oil outlet screw piston at the bottom of the engine, drain out the oil with a container to receive the oil, and replace the oil filter.
2. Screw on the oil outlet screw piston, and then fill in the clean engine oil from the inlet port to the oil level of "H" of the clean-foot scale. Run the engine under the idle speed to inspect whether there are any leakage occurred on the oil filter and oil outlet piston.
3. Turn Engine off, about 10 minutes later, allow the engine oil fully to flow back into the

oil pan, and re-check the oil level, if the oil is in shortage, please refill the oil until the oil falls between "L" and "H" level of the foot scale.

**Warning**

**Change the oil filter when change the engine oil.**

## 5.8.7 REPLACEMENT OF ENGINE OIL FILTER

1. Clean the area near to the install seat of the filter of the engine.
2. Remove the oil filter with the belt wrench.
3. Clean the contact surface of the seal gasket of the install seat with a clean cloth. If the old O-ring is glued to the install seat, replace it.
4. Install a new O-ring, fill the new oil filter full with clean oil, and seals the contact surface with a layer of clean engine oil.
5. Install the oil filter to the install seat; tighten it to the surface of the oil filter gasket with install seat. Tighten the oil filter according to the regulated requirement with belt wrench.
6. Inspect oil level; if the oil is insufficient please add more.

**Warning**

**To tighten the oil filter excessive tight may damage the seals and cause leakage.**

## 5.9 INSPECT ELECTRICAL SYSTEM

The electrical system of the machine is mainly consists of batteries, energy conversion devices (generator, starter) and power consuming devices (instruments, devices, etc.).

### 5.9.1 INSPECT BATTERY

Battery is shown as the right figure:



1. Inspect in cold weather

In cold weather, if the battery's electrolyte has been frozen, neither recharge the battery, nor use the other power supply to start the engine, this would cause the batteries on fire;

melt the battery electrolyte prior to starting, and inspect whether there is any leakage.

## 2. Inspect the battery shell

Do not add more power if the battery case cracks or leaking battery acid, identify the reason then replace the battery.

## 3. Inspect the liquid level of battery

The installed battery is of maintenance-free type, without the necessity to add the battery electrolyte (distilled water) to the battery cell. When the charging indicator turns gray, it shows that the electrolyte is insufficient, probably due to leakage or the failure of charging system. Must find out the fault and replace the battery.

## 4. Inspect the charging state

Inspect the charging status by reviewing the indicating inside the device.

- 1) Green: Normal.
- 2) Black: Charging is not sufficient.
- 3) Pale: No longer available and cannot charge.

## 5. Inspect the battery terminals

- 1) The battery has the terminals broken cannot be recharged, investigate the reason before replace the battery;
- 2) When there are any oxide surfaces over the terminals, please remove the oxide surfaces and clean the terminals before charging.

## **5.9.2INSPECT ELECTRICAL DEVICES**

### 1. Inspect in cold weather

In cold weather, remove the water, snow or mud covered on the wire, cable plug connectors, switches, or sensors, as well as those parts, to avoid parts failures;

### 2. Inspect lighting equipment, etc.

- 1) First inspect the lights, horn, wiper and other electrical components to find out whether they are fault-free or not;
- 2) If there is any error, then inspect the corresponding fuse to find out whether there is any error according to the schematic, if there is any error, replace it;
- 3) If the relevant fuse has no error, then inspect the electric cable of each electric parts with the entire vehicle charged with electricity, to inspect whether there is 24V voltage, if no voltage, then inspect the power cable between electrical parts and the fuse is broken or not;
- 4) If the voltage is measured, please replace the relevant electric parts.

### 3. Inspection of Instrument and equipment

- 1) After the machine is powered on, inspect whether instrument indications are normal;
- 2) In case of any failure, first inspect whether the sensors are damaged or not; in case of no damage, inspect the corresponding temperatures in the following table to confirm whether the resistances meet the requirements in the table below.

Temperature (°C)	Comparison of the temperature sensor parameters						
	Resistance (Ω)						
40	218±30						
80	56±3						
100	30.5±0.5						
120	17.75±0.4						
Pressure sensor parameters comparison							
S/N	1.0MPa hydraulic and pneumatic sensors			2.5MPa air pressure sensor			
	Pressure (MPa)	Resistance (Ω)	Permissible error (Ω)	Pressure (MPa)	Resistance (Ω)	Permissible error (Ω)	
1	0.0	10.2	±5	0.0	10.2	±5	
2	0.1	30	±5	0.25	30	±5	
3	0.2	48	±5	0.5	48	±5	
4	0.3	65	±5	0.75	65	±5	
5	0.4	82	±5	1.0	82	±5	
6	0.5	99	±5	1.25	99	±5	
7	0.6	116	±5	1.5	116	±5	
8	0.7	134	±5	1.75	134	±5	
9	0.8	151	±5	2.0	151	±5	
10	0.9	168	±5	2.25	168	±5	
11	1.0	184	±5	2.5	184	±5	
General Parameters of Fuel Sensor							
Oil Level	Empty oil level	1 / 8 oil level	1/4 Oil Level	1/2 Oil Level	3/4 Oil Level	7/8 Oil Level	Full oil level
Resistance	10±5	33±5	58±5	95±5	132±5	157±5	180±10

- 3) If the sensor is fault-free, then inspect the cable from each sensor to the front of the instrument, to inspect whether it is normal without damage or not.
- 4) If there is no damage, then loose, short circuit and, connect a small resistor in series, then the indicator will display the max. value, the indicating hand does not point to a mark, if it cannot normally indicate, and then replace the meter.

### 5.9.3 SOLDERING

When perform soldering on the whole machine, follow the following regulations to avoid damage to machinery and security incidents.

1. Before soldering, shut down the engine, unplug the key switch, turn off the negative pole switch of battery;
2. Before soldering, must remove the wiring harness connectors of the dashboard to avoid damage to instrument;
3. While welding, must keep away from the wire bund of the machine and take measures to avoid flash and the damage caused by flying sparks;
4. Continuously use the voltage more than 200V;
5. Keep the length of the cable between soldering region and grounding is of within 1m;
6. Avoid to arrange the seals and bearings in the area between the soldering region and the grounding cable;
7. Do not weld the pipe with fuel, engine oil and hydraulic oil;
8. Do not weld containers sealed or with poor ventilation.

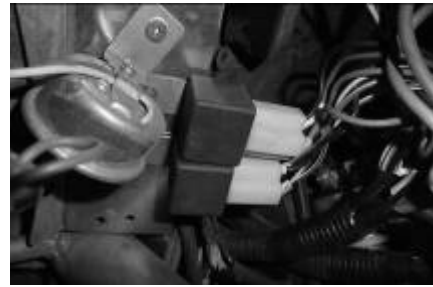

## **5.10 TRANSMISSION OIL MAINTENANCE**

### **5.10.1 INSPECT OIL LEVEL OF GEARBOX**



Refueling port of the gearbox is at the left side of the frame articulated section; please inspect the oil level of the gearbox regularly according to the regulated cycle.

Gearbox may be damaged if its oil level is too high or too low. Please keep transmission oil level in the correct position.

Fill from the refueling port of the gearbox.

Judging criteria:

When the engine stopped, oil is drained out from the screw piston at the upper oil level;

When the engine runs, the minimum oil level does not lower than the screw piston at the bottom oil level.

In course of inspecting oil level of gearbox, replacing transmission oil and replacing the fine filter of the gearbox. We must pay great attention to the cleanliness, prevent the dirt from entering the transmission system and avoid damage to the gearbox.

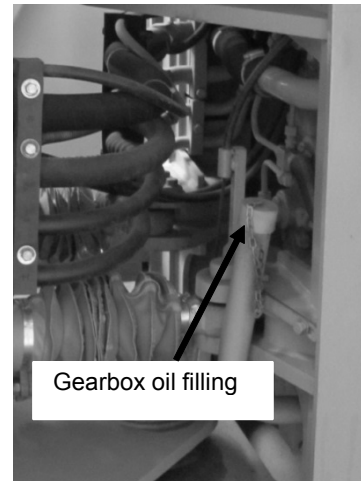

### **5.10.2 TRANSMISSION OIL REPLACEMENT**

It is required to replace transmission oil within the regulated oil change cycle. And the replacement procedures are as follows:

1. Park the machine on the flat ground, and set the speed shifting handle in neutral gear shift, rotate the button of the parking brake to reset, and put on a fixed frame rod, to prevent the car from moving and rotating.
2. Start the engine and run it at idle speed, when the engine oil temperature reaches its operating temperature (about 80°C ~ 90°C), the engine turns off.
3. Drain out the oil by unscrewing the oil outlet screw piston at the bottom of the gear box.

As the oil is still at a higher temperature, therefore it requires wearing protective equipment, and careful operation, so as to avoid personal injury.

4. When replacing transmission oil, it is necessary to replace the fine filter of the gearbox as well.
5. Remove the transmission oil pan. Clean the filter screen with compressed air or diesel fuel.
6. Install transmission oil pan, drain plug and corresponding sealing elements.

7. Refuel the clean transmission oil from the oil filling pipe of the gearbox, and inspect the oil level of gearbox according to the above method, and fill to the regulated oil level.
8. Before replacing transmission oil, cover the parking brake well to prevent the friction plate of parking brake from oil and reduce the brake performance.

## **5.11 MAINTENANCE OF DRIVE AXLE OIL**

### **5.11.1 INSPECT OIL LEVEL OF DRIVE AXLE**

Inspect the oil level of the drive axle according to the regulated cycle.

Too high or too low oil level of drive axle will result in damages to drive axle, and keep the oil level of the drive axle in the correct position.

Drive axle fueling and oil level judging criteria:

Fill oil from the filling port of the left and right wheels, and take the oil overflowing out with the middle oil piston of the axle off as the oil fully filled.

Inspection procedures:

1. Drive the machine to a flat and open ground, slowly move the machine with low oil charging, keep the oil level mark of the front drive axle wheel-side to be located at the level position.
2. As the oil level meter lines of front and rear drive axle cannot simultaneously locate in a horizontal position, so the oil level of front and rear drive axle should be inspected twice.
3. Rotate the parking brake handle for braking. Place the speed changing handle in neutral gear position, and put on a fixed pole frame to prevent the car moving and rotating.
4. Let the engine run 10 at idle speed.
5. Remove the oil outlet screw piston, the oil level inside the drive axle should be located at the lower edge of the oil outlet port. If the oil level is below the lower edge of the oil outlet port, it requests to add clean drive axle oil. Observe 10 minutes after fueling to confirm the oil level is stable or not.
6. Screw on the oil outlet piston.
7. Inspect the oil level of the rear driving according to the above operation procedures.

### **5.11.2 REPLACEMENT OF THE DRIVE AXLE OIL**

It requires replacing drive axle oil within regulated cycle.

The replacement procedures are as follows:

1. Drive the machine to park at a flat ground; slowly move the car with low oil supplying, to keep the oil outlet screw piston at the end side of the wheel rim of the front drive axle to be located at the lowest position.
2. As the oil outlet screw pistons at the end side of the wheel rim of the front drive axle cannot be located at the lowest position at the same time, therefore, the front and rear drive axles should replace oil twice.
3. Rotate the button of the parking brake to reset it. The handle of the speed changing should be placed at neutral position, put on frame fixing bar to avoid car moving and rotating.
4. Run the engine for 10 minutes under idle speed, and the engine turns off.
5. Screw off the oil outlet screw piston at the end surface of the wheel rim of the front drive axle, and the oil outlet screw piston at the middle part of the axle, drain out the oil and receive the oil with container.
6. Refuel according to the above-mentioned “drive axle refueling and oil level judgment criteria”.
7. Screw on the oil outlet screw piston.
8. Repeat the procedure to inspect the oil level of the rear drive axle
9. Since the oil may at relatively high temperature, it is necessary to wear protection tools and facilities, and handle with care to avoid injuries.

## 5.12 INSPECTION AND REPLACEMENT OF TIRE



**If the tire or wheel rim is handled mistakenly, tire may burst or broken and wheel rim may be damaged and spread, which may result in serious injury or death.**

Maintenance, dismount, repair and installation of tire and wheel rim need special equipment and know-how, so you must bring it to tire repair shop to repair, or by specially trained personnel to carry out and comply with all relevant safety requirements.

Recommend to use dry nitrogen (N<sub>2</sub>) to full the tires. If the original tires are filled with air, it is recommended to use nitrogen gas to adjust its air pressure, nitrogen can be mixed with atmospheric gases. Tires filled with nitrogen can reduce the possibility of explosion.

When tire pressure is inspected and adjusted, it should be carried out after the tire is fully cooled.

Pressure of Nitrogen inflated tire is the same as that of the air-inflated tire.

## 5.13 MAINTENANCE FOR LONG TIME PARKING

If the machine will be stored for a long time exceeding one month, the following steps

should be followed with:

1. The machine should be stored in dry room. If the car has to be parked in the open air, it should be stopped on the concrete ground for easy drainage of water, and cover it with canvas.
2. Before store the car for a long time, please completely clean each part of the car, do not leave any dirt or mud on the surface and air it dry.
3. Put the bucket down level on the ground, set the gear shifting joystick at neutral position. Rotate the button of the parking brake to reset it, push the negative switch to the off position, and lock the door of the cab.
4. Fill diesel full into fuel tank, fill lubricating grease over the pins and shafts, and smear a layer of engine oil over the exposure part of the piston rod of the hydraulic cylinder.
5. Dismount the battery and store it separately.
6. If the temperature drops down to below 0 °C , add anti-freeze fluid into the engine cooling system, and to fill the anti-freeze fluid to reach to the engine body and the evaporator of the air conditioner system.
7. Drain out the water in the cooling system, please note to drain out the water in the evaporator of the air condition system.
8. Start the car once a month, to run each system, and fill lubricating grease over all moving pins and shafts, to ensure all moving parts to be lubricated. Before star the engine, remove the engine oil over the piston rod.

## 5.14 MAINTENANCE UNDER SPECIAL CONDITIONS

Maintenance for the operation in mud, water or rain
<p>Inspect the connections around the car to confirm whether there are loose joints, machine damage or leakage.</p> <p>After operation is completed, clean the mud, rocks, gravel, etc. left on the machine; inspect the welding seam to confirm whether there are cracks and whether there is loose; carry out daily lubrication and maintenance.</p> <p>If the car is working in acid rain or corrosive media, please flush to clean the affected parts with clean water rinse.</p>
The maintenance under heavy dust or very hot environments
<p>Clean the air filter more frequently.</p> <p>Flush the surface of the heat radiator to remove the embedded dust and dirt.</p> <p>More frequent replacement of fuel filter.</p> <p>If necessary, inspect and clean up the starter motors and generators.</p>

The maintenance for the operation in rocky environment,

Inspect the wheel and tire assembly to confirm whether there is any damages or excessive wear and tear.

Inspect joints and fasteners to confirm they are loose or damaged.

More frequently inspect the bucket or breaker to confirm whether they are damaged or excessively worn.

If necessary, install the anti-litter fence at the top and front of the windshield of the cab.

The maintenance of the operation under special cold area

Use the fuel which is compatible with the ambient temperature

Use the antifreeze which is compatible with the ambient temperature.

Confirm the battery's ambient temperature, as for the especial coldness, remove it at night, and store it in a warm place.

Remove the slurry on the body timely, in order to prevent damaging the equipment due to freezing.

## 5.15 MAINTENANCE OF HYDRAULIC OIL

### 5.15.1 INSPECT THE OIL LEVEL OF THE HYDRAULIC OIL

Hydraulic oil tank is below the staircase on the left of the frame. The round oil mark indicating the level of the hydraulic oil is in the front of the hydraulic oil tank.

When inspecting the oil level of the hydraulic oil, park the car on a flat ground, put the bucket on level ground, at this time, the hydraulic oil level should reach the middle position of upper oil mark.



### 5.15.2 REGULAR REPLACEMENT OF HYDRAULIC OIL

Every 2000 working hours or every year the hydraulic oil should be replaced. If the oil deterioration occurs due to poor working conditions, or hydraulic oil is contaminated, such as the color changes to black, oil foaming, please replace the hydraulic oil.



**During the oil changing process, the machine need to be operated at a variety of**

**actions, please note to perform in accordance with the relevant safety regulations. During the oil change process, we should pay great attention to cleanliness of the oil, do not let dirt coming into the hydraulic system.**

1. Clean up the impurities and debris in the bucket, and park the car at the flat and open spaces, install a fixed frame rod, rotate the parking brake button to reset it, speed changing handle is placed in the neutral position. Start the engine and run it at idle speed for 10 minutes, during the previous process, repeat several times to lift the lift arm, lower down lift arm, forward dumping the bucket and backward dumping the bucket, and other activities.
2. Finally, raise the lift arm to the highest position, and tilt backwards the bucket to maximum position, the engine turns off.
3. Firstly push the pilot joystick to the right, so that the bucket is tilted forwards under its own weight to pour out the oil in the bucket cylinder; after the bucket turns to right place, push the joystick forward and the lift arm lowers under its own weight to pour out the oil in the lift arm cylinder
4. Push the pilot joystick to the middle position.
5. Clean up the oil outlet cover at the bottom of the hydraulic oil tank, screw off the oil outlet screw piston and receive the oil with container. At the same time, screw off the air filter to speed up the process of draining oil.
6. Remove top cap of the oil return filter of the hydraulic oil tank, replace the oil return filter element. Dismount the top cap of the oil filter of the hydraulic oil, and replace the filter element.
7. Block the sucking back port of the hydraulic oil tank with a clean cloth, flash to clean the inside wall of the hydraulic tank with diesel from the top cover installation port of the sucking back filter of the oil tank, and drain out the oil from the oil outlet pipe. Finally, clean the bottom of the oil tank and four sides of the wall with a clean dry cloth, take out the cloth blocking at the oil sucking port.
8. Install the oil outlet screw piston for hydraulic oil drainage, return oil filter, oil suction filter and top cap.
9. Fill clean hydraulic oil for the refueling port of the hydraulic oil tank, so that the hydraulic oil level reaches the middle position of upper oil mark of the hydraulic oil, screw on the refueling cap.
10. Remove the frame fixing rod, start the engine, operate the pilot joystick for lifting the lift arm 2-3 times, tilting the bucket backwards and forwards and turning the bucket to the left and right to the maximum angle, fill the oil cylinder with hydraulic oil. Then let the engine run at idle speed for 5 minutes to exhaust air from the system.
11. Engine turns off, open the hydraulic tank filler cap, and add clean hydraulic oil to the middle position of the upper oil mark of the hydraulic oil tank.



If the hydraulic oil has been seriously polluted, in addition to drain out the hydraulic oil from the hydraulic tank, heat radiator of hydraulic oil, lift arm cylinder, bucket cylinder with the above mentioned method, open the end with a pipe, to drain out hydraulic oil in the cylinder and inner cavity of various pipes. Then fill the clean hydraulic oil to the middle position of upper oil mark.

## 5.16 BUCKET MAINTENANCE

### 5.16.1 REPLACE BUCKET O-RING

#### **Warning**

As metal objects may fly out, it is better to wear safety helmets, gloves and eye protection cover when replace the pin.

Inspect the O-ring on the bucket, if it is worn or damaged, please replace it.

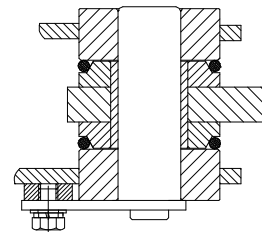

Figure 1

Release the pin platen bolts of the bucket (1, Figure 2), and then remove the bucket pin (2), take out the lift arm (3).

Remove the old O-ring, install the new O-ring (4, Figure 3), and confirm that the O-ring on the lift arm (3) groove has been cleaned.

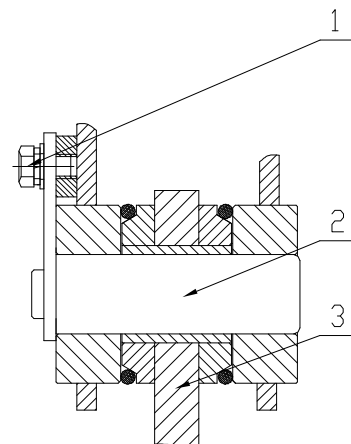

Figure 2

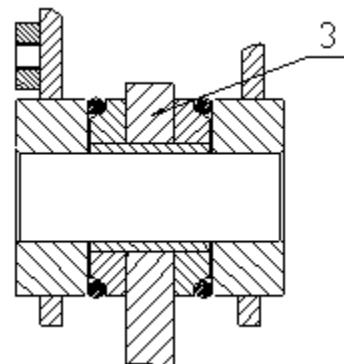

Figure 3

Find out the lift arm pin hole and bucket pin hole,  
to install the bucket pin (2, Figure 4).

Lock the Pin Plate bolts of Bucket (1, Figure 2).

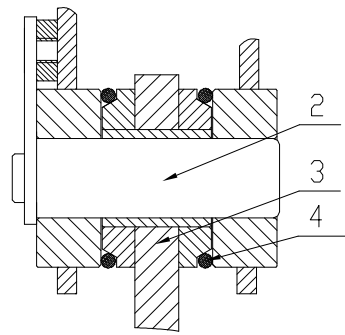

Figure 4



## CHAPTER VI COMMON FAULTS AND TROUBLE-SHOOTING

Fault	Cause	Action	
Diesel engine cannot start to run.	Shift is not geared on.	Switch for gearing again, or re-adjust the variable speed handle of the system	
	Oil level of the gearbox is too low.	Fuel to the regulated oil level.	
	Handle rod of the speed changing valve cannot return to original position.	Find out the reason not returning to right position and remove.	
	Speed changing oil pump is damaged or oil seal is leaking.	Replace oil pump or oil seals	
	Oil Pump is in poor sucking conditions.	Inspect whether the Oil sucking Pipe fails or not.	
Lack of driving force	Low pressure of the oil outlet port of the torque converter is low, and the torque converter voltage fails.	Inspect oil level of the gearbox, clean the oil filter of the oil pan and oil filter of the outlet.	
	Engine speed is insufficient.	Inspect engine speed.	
	Clutch slips	Inspect the speed changing oil pressure and the oil seal of the piston.	
	Oil temperature of the torque converter is too high	When the oil temperature of the torque converter is higher than 120°C, stop the car for cooling down.	
Pressure for changing speed is too low	Pressure release Valve group fails.	Find out the reasons and perform maintenance	
	Oil filter is blocked	Clean the oil filter	
	Pump Failure	Replace oil Pump	
	Oil seal of the clutch is leaking oil seriously.	Change oil Seal	
Oil level of the gearbox is increased	Oil flying out from the end of the steering pump	Replace the oil seal of the shaft side of steering pumps.	
	Oil flying out from the end of the shaft of the working pump of the hydraulic system	Replace the oil seal of the shaft ends of the steering pump.	
Oil temperature of torque converter is too high.	Oil level of the Gearbox is too high or too low	Fuel to the requested oil level	
	Clutch slips	Inspect the oil pressure of the clutch	
	Filter is blocked	Clean oil filter screen and oil filter of the oil pan of the gearbox.	
	Speed changing Pump is in bad oil suction condition	Inspect speed changing pump to confirm the oil hose is offset or blocked	
	Speed changing pump wears, fuel supply is insufficient.	Inspect the speed changing pump to confirm that there is any leakage or not, and remove it.	
	Oil cooler partially is blocked	Inspect and clean oil cooler of the gearbox.	
	Oil deteriorates		Inspect oil used for double change (add volume and fuel quality) to confirm it meets the requirements or not
			Inspect the oil returning pressure of the torque converter is not too high or not, hydraulic resistance is too high may lead to a rapid increase of the oil temperature in the oil return system.
The idle stroke of the steering wheel is over-sized.	Loose steering wheel nut	Make adjustment as required	
	Worn or damaged connection between steering column and steering gear	Disassemble and repair	

<b>Fault</b>	<b>Cause</b>	<b>Action</b>
Steering torque is insufficient	Loss flow of steering pump is inadequate	Inspect or replace the steering pump
	Pressure change of the safety pressure valve	Adjust its pressure (pressure)
	Steering pump leaks seriously inside.	Repair or replace
Lift arm raising force or bucket tilting force is inadequate	Oil seal of the cylinder is worn or damaged	Change oil seal
	Distribution valve is excessively worn, the fitting gap between valve rod and valve body exceeds the specified value.	Dismount and repair, to make the clearance reach to the required value or replace the distribution valve
	Pipeline system leaks oil.	Find out the leaking point and remove it.
	The working pump/steering pump seriously leaks inside.	Replace working pump//steering pump
	Safety valve is adjusted improperly; the system pressure is too low.	Adjust the system pressure to the specified value
	Oil tube and oil filter is blocked	Clean oil filter and change oil
Energy accumulator cannot be normally released.	Oil pipe or joint of energy accumulator leaks.	Check oil pipe or joint for leakage and replace it.
	The charging pressure of energy accumulator is wrongly set.	Check the charging pressure of energy accumulator.
	The oil pipe of energy accumulator is blocked.	Check the oil pipe of energy accumulator.
	Filling valve does not work.	Replace the filling valve.
Energy accumulator begins to be filled with liquid, but cannot reach the upper pressure limit.	There is no oil in oil tank or oil level is too low.	Check the oil level in oil tank.
	Pump is too old or does not work and it cannot transmit the whole flow or pressure.	Check the pump.
	Filling valve does not work.	Replace the filling valve.
Filling time of energy accumulator is too long.	Pump is too old or does not work and it cannot transmit the whole flow or pressure.	Check the pump.
	Filling valve does not work.	Replace the filling valve.
Filling of energy accumulator fails.	There is no oil in oil tank or oil level is too low.	Check the oil level in oil tank.
	Pump is too old or does not work.	Check the pressure or flow of pump.
	Overflow valve does not work.	Check the setting of overflow valve.
	Air exists in oil pipe of energy accumulator.	Release the air in oil pipe.
	Filling valve does not work.	Replace the filling valve.

<b>Fault</b>	<b>Cause</b>	<b>Action</b>
Filling frequency of filling valve is too high.	The charging pressure of energy accumulator is wrongly set.	Check the air pressure of energy accumulator.
	Filling valve does not work.	Replace the filling valve.
No enough oil or liquid passes through filling valve.	Pump does not work.	Check the flow and pressure of the pump.
	Pipeline is blocked.	Replace oil pipe.
	Filling valve does not work.	Replace filling valve.
Reaction of brake is very slow.	The brake cannot be properly adjusted.	Adjust the brake.
	The brake does not work.	Check the brake.
	Hydraulic pipeline or joint leaks.	Check leakage and make repairs.
	Automatic adjuster does not work.	Check the operation of adjuster.
Braking is not adequate.	There is no oil in oil tank or oil level is too low.	Check the oil level in oil tank.
	The brake cannot be properly adjusted.	Check brake adjuster.
	There exists oil or grease on brake disc.	Remove oil dirt or replace with new brake disc.
	Brake pipeline leaks.	Check pipeline.
	Automatic adjuster does not work.	Check the operation of adjuster.
	There is no charged pressure in energy accumulator or pressure is inadequate.	Check energy accumulator for air charging/.
	The brake does not work.	Check the brake.
	The brake valve does not work.	Check the brake valve.
Braking is too sensitive.	Pump is worn out.	Check the system pressure.
	The brake does not work.	Check the brake.
The brake is incompletely released.	The brake valve does not work.	Replace the brake valve.
	The brake cannot be properly adjusted.	Adjust the brake.
	The brake does not work.	Check the brake.
	Angle of pedal is outside the range of adjustment.	Adjust the angle of pedal.
	The oil cylinder on the wheel does not work.	Replace the oil cylinder on the wheel.
	Automatic adjuster does not work.	Check automatic adjuster.
	Air exists in the brake.	Release the brake.
	Oil return pressure in oil return pipe is too high.	Reduce the pressure.
No braking	The brake valve does not work.	Replace the brake valve.
	There is no hydraulic oil in the system.	Check the oil level in oil tank.
	Brake pipeline leaks oil.	Check the pipeline for breakage or damage.
	The brake cannot be properly adjusted.	Adjust the brake.
	Automatic adjuster does not work.	Check the pressure of brake pipeline.
	Brake does not work.	Check the brake.
Pedal rebounds when the brake is operated.	Brake valve does not work.	Replace the brake valve.
	Brake pipeline has air.	Empty the air in brake pipeline.

<b>Fault</b>	<b>Possible cause</b>	<b>Fault phenomenon</b>	<b>Elimination method</b>	
Refrigeration function of air-conditioning system does not work	Refrigerant leak in the system	No pressure indication	Identify other causes Refill with refrigerant	
	Electrical devices (compressor/evaporating fan/condensate fan) work properly or not	Normal pressure indication	Replace defective devices	
	Compressor does not work	Loose or broken belt	Normal pressure indication	Replace the belt or adjust it to a value within prescribed limit
		No pull-in of clutch/ circuit problem		
	Circuit fault	Loose plug connector	The controlled electrical device does not work	Repair or replace defective parts
		Blown fuse	The electric device does not work	
		Failure of temperature controlled switch	Compressor does not work	
		Damaged pressure switch	Compressor does not work	
		Damaged relay	The controlled electrical device does not work	
		Damaged refrigeration switch	Devices other than evaporating fan do not work	
		Damaged air volume switch	No electrical device works	
	Other circuit damage	The controlled electrical device does not work		
	Plugged expansion valve	Low pressure (negative pressure), frosted outlet of expansion valve	Clean the air-conditioning system and replace drying bottle or expansion valve	
Plugged drying bottle	Low pressure is on the low side and beyond the normal range, or is negative pressure			
		Noticeable temperature difference between pipes on both sides of drying bottle, frost formation on drying bottle		
Inadequate refrigeration	Damaged or not well connected air outlet	Low air speed at air outlet	Repair the air outlet	
	Heater valve for heat exchanger is not closed or leaks water	Heat means the valve is not closed	Close water valve or make replacement	
	Inadequate refrigerant	Both high pressure and low pressure are on the high side	Check leaking positions, add the right amount of refrigerant	
	Surplus refrigerant	Both high pressure and low pressure are on the high side, and there is no air bubble in level glass	Let out the right amount of refrigerant	
	Non-condensable gas within the system	Both high pressure and low pressure are on the high side		
	Filth blockage of air inlet of evaporator/filth blockage within core body	Too much earth and thick dirt on surface/objects clogging air inlet	Clear away the filth	
	Failure of condensate fan	Zero current or no fan operation with damaged fan blades	Check the circuit and motor, make repair or replacement	
	Filth blockage on condenser surface	Too much earth and thick filth on surface	Flush with water	
	Condenser inlet air temperature is too high, or the dissipation of discharged hot air is not satisfactory	Air inlet is above 40°C/air inlet is clogged	Keep air inlet able to take in enough air and natural wind	
	Loose belt	Harsh noise	Adjust the belt	
	Clogged expansion valve	Low pressure indicates negative pressure/frost forms on evaporator	Replace expansion valve, vacuumize again and add refrigerant	
	Damaged expansion valve	No temperature difference between inlet and outlet of expansion valve	Replace expansion valve, vacuumize again and add refrigerant	
	Clogged drying bottle	Low pressure is on the low side and beyond the normal range, or is negative pressure	Replace drying bottle, vacuumize again and add refrigerant	
		Noticeable temperature difference between pipes on both sides of drying bottle		

<b>Fault feature</b>	<b>Cause</b>	<b>Elimination method</b>
Power lamp of MP3 player is not lit up	Reverse polarity connection of power source	Connect to power source
	Disconnected protective tube or open power line	Check and connect power line correctly, replace protective tube
Mute MP3 player	No power voltage	Connect the power line properly
	Open loudspeaker circuit	Connect the loudspeaker circuit properly
	SD/MMC card, U disk have no corresponding format	Check the content of SD/MMC card, U disk
Light (unclear) sound of MP3 player	Internal resistance of power source is too big	Change power source
	Poor contact of aerial plug	Adjust aerial plug
Single track of MP3 player	Open circuit of one loudspeaker line	Connect the loudspeaker line properly



## **CHAPTER VII MAINTENANCE AND SERVICING OF AIR-CONDITIONING SYSTEM**

<b>No.</b>	<b>Item</b>	<b>Content</b>
1	Evaporator	Whether air blower operates with abnormal noise
		Whether air inlet & outlet are smooth
		Whether water drainage is smooth
2	Compressor	Whether fastening bolts loosen
		Whether the tightness of the belt is appropriate
		Whether the clutch pulls in properly
		Whether dust and filth is too much
3	Condenser	Whether the surface of core body is affected by filth blockage and needs periodical cleaning
		Whether electronic fan works properly
4	Pipeline	Whether connections loosen or leak(oil stain at leaks)
		Whether flexible hose is damaged
5	Switch	Whether gears work properly without loosening
6	Electric connector	Whether any electric connector loosens or is damaged
7	Temperature controller	Whether the device works properly and whether indicator lamp is lit up properly
8	System	Whether all parts work properly without abnormal noise

## **CHAPTER VIII ENVIRONMENTAL PROTECTION REQUIREMENT**

When performing maintenance, the parts replaced should not be arbitrarily discarded, and should be recycled.

When performing maintenance, do not put coolant, oil (fuel, engine oil, hydraulic oil, transmission oil, gear oil, grease, etc.), electrolyte or other objects may cause environmental pollution, directly on the ground, use the special containers to collect them and dispose them in accordance with relevant regulations.

The treatment of the pollutants should be complied with local laws and regulations.



## APPENDIX: REFERENCE TABLE OF PROPORTION OF COMMON MATERIALS

S/N	Material name	Category	Specific gravity reference (Kg/m <sup>3</sup> )	Note
1	Ordinary soil	Stick thin dry soil	1250	
		Caking dry soil	1520	
		Powder dry soil	1550	
		Wet soil	1725	
		Mud-like soil	1730	
		Tight soil	1840	
2	Clay	Wet soil	1750	
		Dry soil	1485	
3	Sand	Loose dry sand	1440	
		Wet sand	1680	
		Water-Wet Sand	1850	
4	Sandstone	Broken sand stone	1500	
		Solid sandstone	2300	
5	Gravel	Dry gravel	1485-1650	
		Wet gravel	2015	
		Gravel pit	1900	
		Dry clay mixed	1185	
		Wet clay mixed	1650	
		Dry sand mixed	1730	
		Wet Sand Mixed	2000	
6	Bauxite		1425	
7	Gravel		1600	
8	Slag	Dry	650	
9	Coal	Smokeless Coal	1190	
		Bituminous coal	950	
		Dry peat	415	
		Wet peat	1125	
10	Weathered rock	75% of the geotechnical	1955	
		50% of the geotechnical	1725	
		25% of the geotechnical	1585	
11	Gypsum	Crushing Block	1600	
		Break bulk	1810	
		A solid block	2780	
12	Limestone	Fragmentation	1550	
		A solid block	2600	
13	Slag		1760-2100	
14	Granite	Chunky	1650	
		Overall	2800	
15	Hematite		2460	
16	Magnetite		2780	