

SUMITOMO

SH210-5 SH210LC-5

■ Engine Rated Power (Net) : 117.3 kW · 159.5 PS
■ Operating weight :
SH210-5 20,000~20,700 kg
SH210LC-5 20,400~21,200 kg
■ Bucket : ISO/SAE/PCSA Heaped : 0.50~1.1 m³

LEGEST



SUMITOMO (S.H.L.)
CONSTRUCTION MACHINERY
MANUFACTURING CO., LTD.

731-1 Naganumahara-cho, Inage-ku, Chiba, 263-0001 Japan
For further information please contact: Phone : +81-43-420-1796 Facsimile : +81-43-420-1907

We are constantly improving our products and therefore reserve the right to change designs and specifications without notice. Illustrations may include optional equipment and accessories and may not include all standard equipment.



MADE IN JAPAN

The world knows that Japanese design and manufacturing is the best especially for industrial products. The hydraulic excavator is not the exception when a total integration concept is required in design work involving key components, manufacturing engineering and product quality assurance in the factory.

All SUMITOMO hydraulic excavators are engineered and assembled SUMITOMO's its one and only factory located in Chiba City, Japan, and distributed to each country in the world. This distinctive feature is unique to SUMITOMO, giving the SUMITOMO machine users total comfort and reliance on product quality.

(Note: Some of the items manufactured and sourced in other countries may be assembled in Japan.)

·The new engine complies with the Emission Regulations U.S. EPA Tier III, and EU Stage IIIA.

·The advanced low noise design complies with the upcoming EU noise regulation 2000/14/EC, STAGE II.

Engine and Hydraulics 04 - 07

- SPACE 5
- SIH'S
- New working mode

Durability 08 - 09

- Stronger boom and arm
- Durable bucket
- Ridged swing frame
- Improved undercarriage

Maintenance 10-11

- High performance hydraulic return filter
- Fuel tank
- Engine oil drain coupler
- Ground level maintenance

Operator Comfort 12 - 13

- Spacious cabin
- Comfortable operator's seat
- Message display from LCD monitor

Safety 14

- Optimised view from cabin
- High -rigidity cabin structure

Customer and Product Support 15

Specifications 16 - 23

Engine and Hydraulics



- ① Powerful ② Economy ③ Clean ④ Silent ⑤ Strong
 "SPACE5" is a new engine system consisting of five (5) special features.

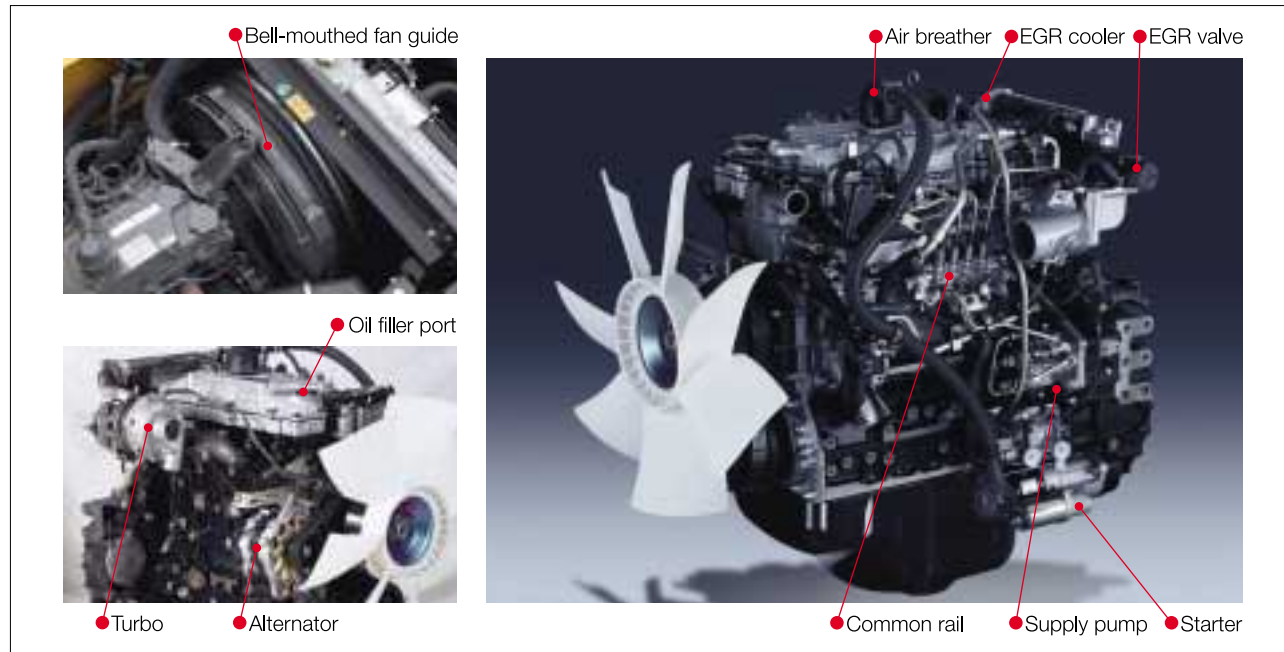

Engine

A newly developed ISUZU engine 4HK1X complies with Emission Regulations U.S. EPA Tier III and EU Stage IIIA. This produces bigger output and torque, and far better fuel consumption than the previous model.

Common Rail Type High-Pressure Fuel Injection System

The system is equipped with a common rail type high-compression fuel injection system, which permits high-precision injection from multiple injection under ultra high-pressure of more than 1600 atm. Precise control of injection time and injection quality at that rate of 1/1000 second optimizes combustion, improves combustion efficiency, and reduces PM (particulate matter) substantially.

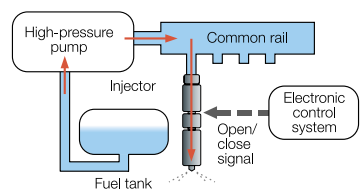

Comparison of engines

	SH200-3	SH210-5	Merit
Name of engine	ISUZU-6BG1T	ISUZU-4HK1X	
Type	12-valve OHV	16-valve OHC	
Displacement	cc 6494	5193	
Number of cylinders - Dia. x Stroke	mm 6-105 x 125	4-115 x 125	
Rated output	kW/min ⁻¹ 103/1,950	117/1,800	Higher output (+14%)
Max. torque	Nm/min ⁻¹ 532/1,600	628/1,500	Higher torque (+18%)
Size (Length-Width-Height)	mm 1204-768-961	1020-829-1012	
Cylinder block	Bearing CAP	Ladder frame	High rigidity/low noise
Fan belt	V-Belt	Poly V-Belt	Long life

Cooled EGR System

The EGR (Exhaust Gas Recirculation) mixes the gas, which is once exhausted, with the air that is taken in so as to lower the combustion temperature, thereby reducing NOx (nitrogen oxide). Adoption of the cooled EGR system, in which a water-cooling cooler is installed in the middle of the re-circulation pipe, permits further decrease in the suction temperature, ensuring a better NOx reduction effect than the ordinary EGR.

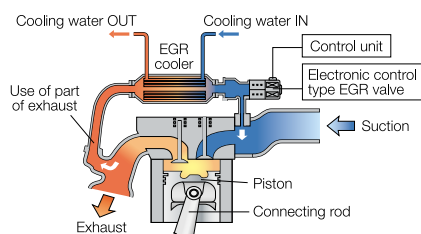

16 valve OHC Turbo Engine with Inter-Cooler

When the inter-cooler cools the intake air, which is compressed by a turbocharger and has reached a high temperature, the density of the air increases and the suction efficiency increases. Therefore, NOx and PM can be reduced substantially, permitting high output and improvement of fuel efficiency simultaneously.

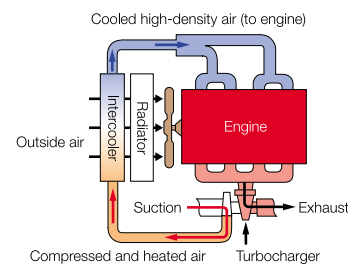

- 8% increase in bucket digging force
- 7% improvement in arm closing speed under heavy excavation
- 24% increase in bucket closing speed
- 4% increase in traction force

* As compared with SH200-3

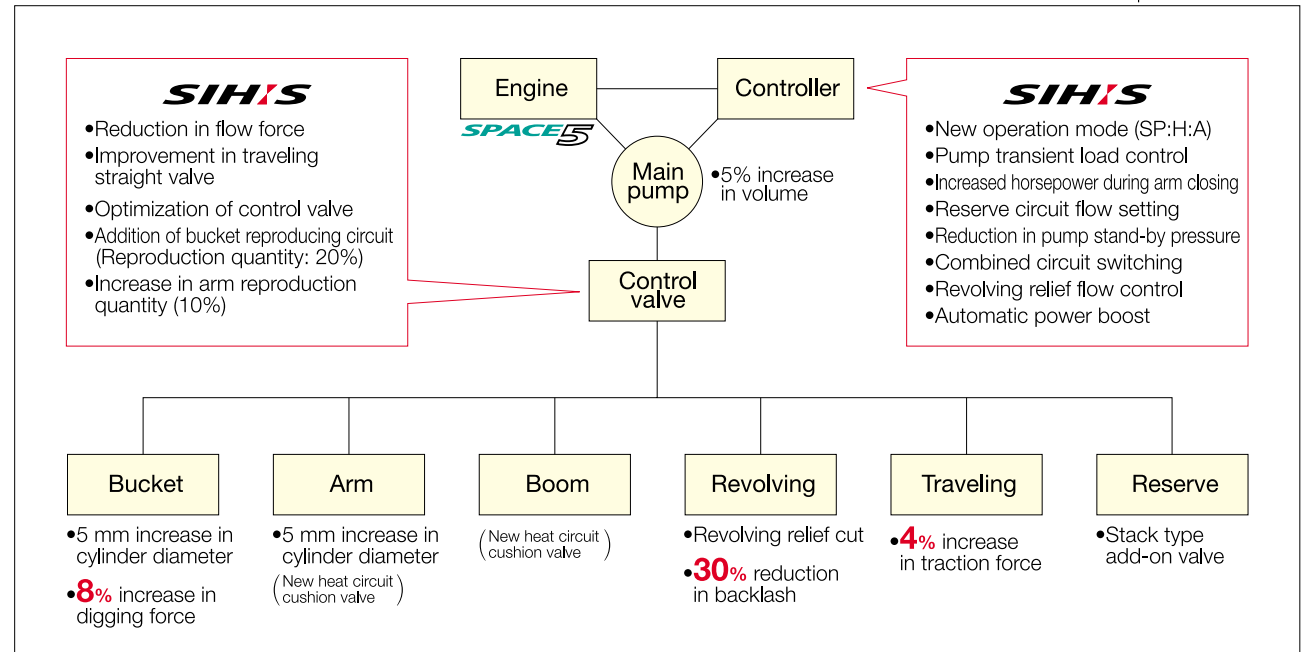

Real Digging Power

The true digging force can not be expressed by a maximum digging power figure listed in sales materials. With a much improved hydraulic system and by adopting a larger arm cylinder, the arm-in motion speed slowdown is minimized by seven percent (7%) in comparison with the previous model. The digging power when combined with the attachment speed in motion convey to the operators "real digging power".

Quick and Smooth Control Response

A total review of the hydraulic circuit and miscellaneous hydraulic settings guarantee speedy and precise operation through a smooth control lever.



SP (Speed Priority mode)

SP "Speed Priority" mode has been developed, which is not available in competitors models nor in our previous model. This will create biggest productivity in its class with more economical fuel efficiency even in comparison with the Heavy mode of our previous model. In addition, the throttle control is simple to use.

- SP mode: 5% increase in workload
- * As compared with SH200-3 (H mode)

Multifunctioning Capability for Upper and Travel Operation

With the new hydraulic circuit, travel motion slowdown will not be experienced even during the combined operation of attachment and swing motion when traveling.



Engine and Hydraulics

The integration of the new engine system "SPACE 5" and new hydraulic system "SIH:S" has created 20% fuel efficiency improvement in comparison with our conventional model.

New engine system



10%

+

New hydraulic system



10%

||

20% reduction in fuel consumption compared to SH200-3 (H mode)

*The fuel consumption may vary from time to time depending on site and working conditions, operator skill and other circumstances.

Greater productivity and increased working efficiency



Hydraulic Oil Flow Control

SUMITOMO unique design

In the case of sudden lever movement and high load activation, the newly developed hydraulic control system reduces the main pump oil flow intentionally and keeps the engine speed at a constant level. This enables a reduction in fuel consumption. In addition, this also reduces the level of exhaust smoke due to excessive fuel injection.

Reduction of Hydraulic Oil Flow at Swing

SUMITOMO unique design

The hydraulic oil quantity required at the time of sudden swing motion is limited. The new hydraulic system can start the oil flow volume at the minimum level and then allow it to increase on demand. This optimum oil flow control significantly improves the fuel efficiency.

Reduction in Pump Stand-by Pressure

SUMITOMO unique design

Reducing pump oil flow pressure during stand-by minimizes the load on the engine. This also improves fuel consumption.

Increased Pump Efficiency

The new modified hydraulic pump structure lowers the oil leak volume in the pump which means improved pump efficiency and improved engine fuel efficiency.

Mode Selection by Throttle

Mode selection by pressing the button in our previous model sometimes cause inconveniences for the operator. The throttle control system has been upgraded and the new system "A" mode which stands for "Adjustment Mode" now covers the 3 previous modes of "Auto, Standard and Light". In addition there is "H" (Heavy) mode and "SP" (Speed Priority) mode, and the hydrostatic pump oil flow will be regulated automatically in each of the 3 modes respectively.

The SP mode is added to the operation mode. Furthermore, the A (Adjustment) mode is added to the SP and H modes, respectively. In comparison with the H mode of Dash 3, the SP mode has reduced the fuel consumption by 15%, and the H mode of Dash 5 has reduced the fuel consumption by 20% as compared with Dash 3.



Throttle knob position	1	2	3	4~8	9~15
Engine speed	1,800	1,700	1,600	1,599~1,300	1,299~1,000
Operation mode	SP	H	A		
Automatic power boost	Automatic		Constant		

SH200-3 (Previous model)		SH210-5	
H	HEAVY (Speed priority)	SP	SPEED PRIORITY
A	AUTO (Simultaneous pursuit of speed and fuel efficiency)	H	HEAVY (Simultaneous pursuit of speed and fuel efficiency)
S	STANDARD (Fuel priority)	A (13 steps)	ADJUSTMENT (Ordinary operation /Fine operation /Lifting operation)
L	LIGHT/LIFT (Fine operation / Lifting operation)		

Reduction in fuel consumption by 15%
Reduction in fuel consumption by 20%
Reduction in fuel consumption by 5-10%

Working speed ↑

Durability

Boom & Arm

1. The boom structure is now 2 pieces instead of 3.
2. High strength castings are used for the boom base and arm end.
3. One size larger piping is used for the boom boss area.
4. Thicker steel plate is used for added strength.

The improved boom plate structure has reduced the number of weld sections that reduce the strength, thereby improving the quality.

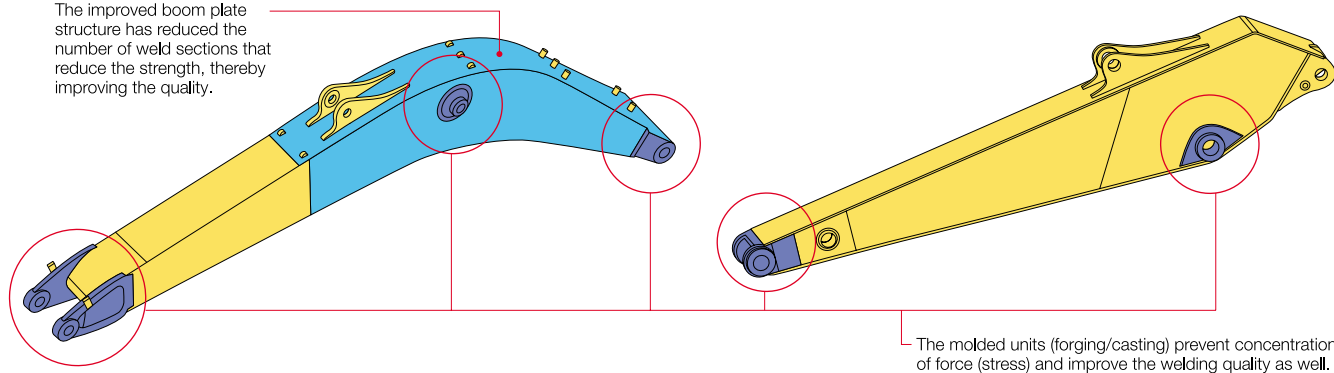

Bucket

A one piece wear plate covers the weldment area to increase the wear life of the bucket.

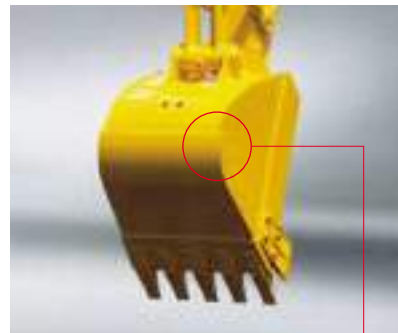

■ Cross section

Protection of weld bottom plate and flattening of bottom plate by changing the bottom plate weld structure

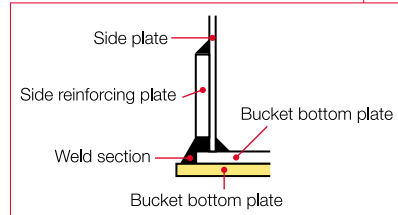

Swing Frame

Reinforced plate on "A" frame is extended and the swing frame base is made in one-piece steel plate.



■ Revolving frame

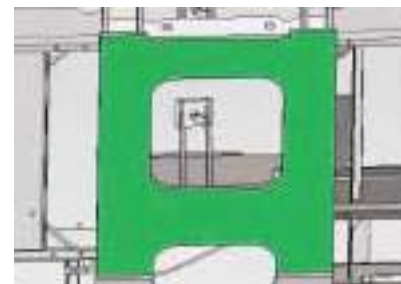

■ A frame

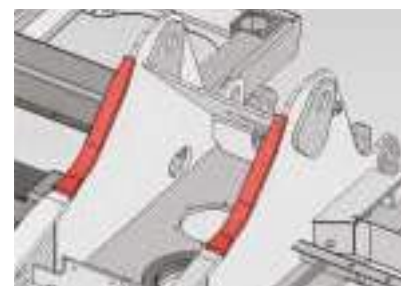

Ridged Upper Side Section Frame

5% increase in rigidity

A closed -section "D" shape structure with thicker plate reduces stress and is high impact resistant.

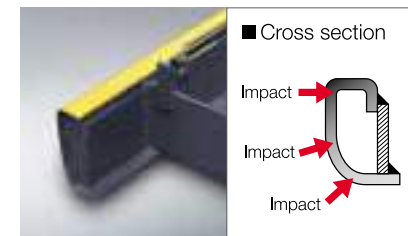

Undercarriage

1 Link shoe

M-type seal increased pin hardness

2 Center joint

Prevention of bolt loosening

3 Recoil Spring

Use of high hardness material

4 Idler

Reinforced boss

5 Travel motor

Improved seal

6 Carrier roller

Tread machining addition of jaw

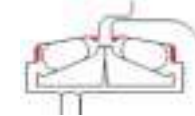

7 Center guard

Change of structure and bigger size

8 Track roller

Tread machining addition of jaw prevention of bolt loosening

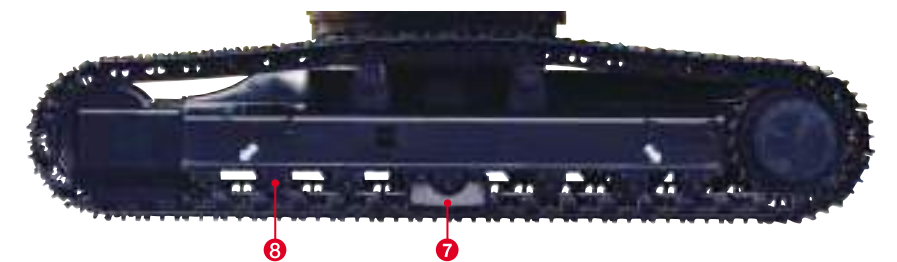
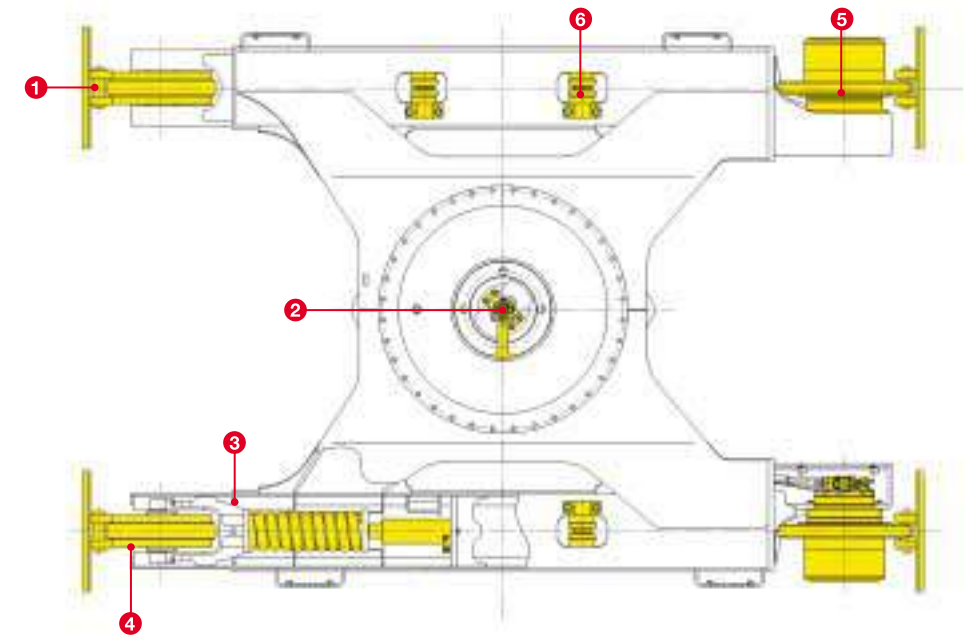
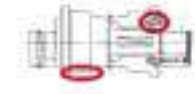

Maintenance

High-Performance Return Filter

The hydraulic oil change interval is 5,000 hours, and the return filter change interval is 2,000 hours. One high performance return filter keeps the same level of filtering effect as a nephron.

- Hydraulic oil change : **5,000 hours**
- Life of filter : **2,000 hours**

* The oil and filter change interval depends on the working conditions.



The High-Performance Return Filter is made more precisely to condense the Nephron filter function.

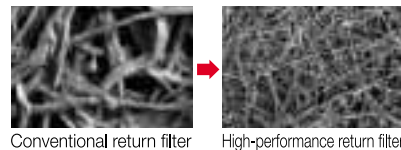

Fuel Tank

Stainless steel is used for the strainer that prevents dust entering during re-fueling. Furthermore, a maintenance hole is provided to permit easy periodical maintenance.



Engine Oil Drain Coupler

The engine oil pan is provided with a drain coupler. This makes easier to do drain work and preventing oil from spattering with an attached drain hose.



EMS (Easy Maintenance System) as Standard

SUMITOMO's new improved EMS keeps the pins and bushes fully lubricated at all times and prevents rattling. This system significantly extends the service life of the pins and bushes.

The interval of greasing around the bucket is 250 hours, and for the other sections is 1,000 hours, keeping the joints lubricated for a long time and extending the service life of parts by reducing abrasion and rattling.

- Bucket greasing interval : **250 hours**
- Greasing interval for other sections : **1,000 hours**

* The greasing interval depends on the working conditions.

EMS bushing

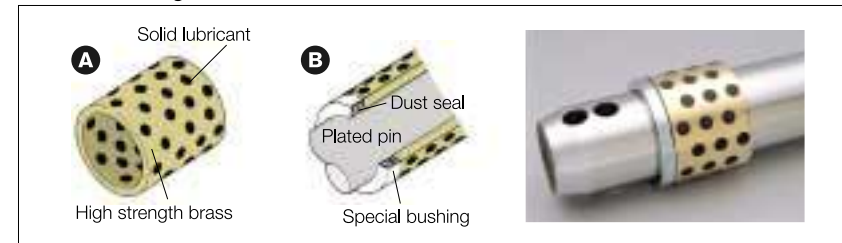

- Ⓐ A solid lubricant embedded in high strength brass forms a layer on the bushing surface to prevent contact between metals, maintaining an excellent lubricated state to reduce abrasion of joints.
- Ⓑ The surface of the pin is plated to increase the surface hardness and improve the wear resistance accordingly.

Steel EMS bushing



Steel EMS is installed around the bucket

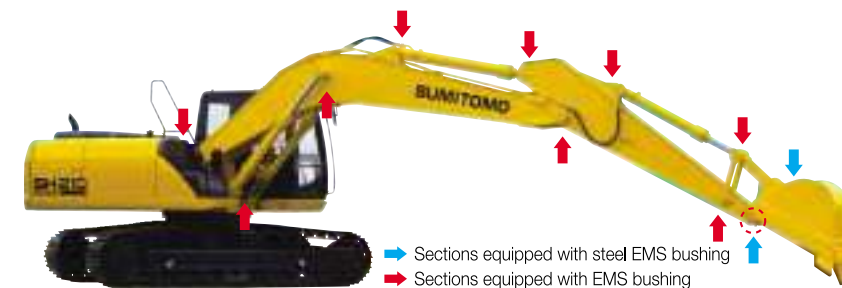

Precautionary use of EMS

- ① Grease is enclosed, however, greasing is necessary every 1000 hours or six months depending on the level of dusting conditions.
- ② Greasing is also necessary after any components have been submerged underwater for prolonged periods.
- ③ Greasing is also recommended after use with hydraulic breakers, crushers or other high impact attachments such as Rock Saws etc.
- ④ Bucket pins should be cleaned thoroughly when removing or attaching new buckets.

Ground Level Access to Engine Area Improves Preventative Maintenance.

Parts cleaning and maintenance are possible from the ground without climbing onto the upper structure of the excavator body.



•Remote fuel and oil filters
A fuel prefilter is provided as standard equipment to reduce trouble due to fuel clogging. In addition, the fuel and oil filters are installed at ground-accessible location to facilitate replacement.

Main fuel filter (with water separator) Engine oil filter Pre-fuel filter (with water separator) Pilot filter

Parallel installation of radiator and oil cooler

A space provided at the front of the intercooler and the tilting condenser facilitates cleaning.

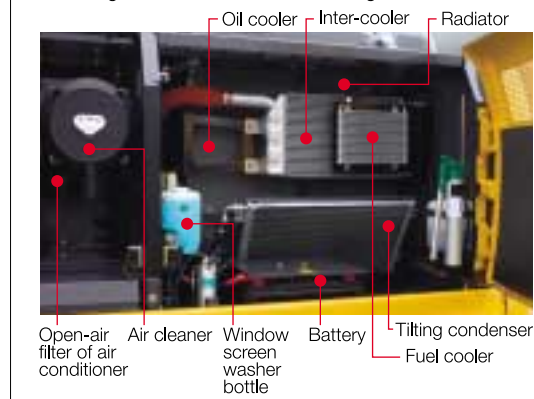

Ease of cleaning around radiator

The radiator and oil cooler are arranged in parallel. Furthermore, a space has been provided at the front of the intercooler and a tilting air condenser has been adopted to substantially facilitate cleaning. Dust build up can be removed easily and prevent overheating.

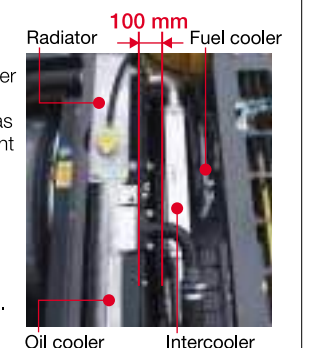

Operator Comfort

SUMITOMO's Redesigned Cabin and Seat for Optimum Operator Comfort

The seat reclining system allows the operator to lay the seat flat and to rest on site without removing the headrest.



Operating Positions of Sliding Seat and Tilting Console

In addition to the tilting console that is adjustable in four steps vertically, the increased sliding distance ensures optimum working conditions.



New Water-repelling Operator's Seat

SUMITOMO unique design

A rainwater and dust-resistant, water-repelling operator's seat has been adopted.

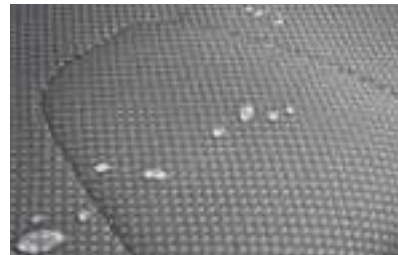

The Suspension Seat Eliminates Vibration



Air suspension (Option)

Simple to Read LCD Monitor and Switch Panel

In addition to the monitor that is easy to read during daytime as well as nighttime by changing the backlight to white, a simple and convenient universally designed switch panel is provided.



Warning message

1. OVER HEAT
2. ALTERNATOR
3. LOW FUEL
4. LOW OIL PRESSURE
5. LOW COOLANT
6. ELEC.PROBLEM
7. OVER LOAD (option)
8. AIR FILTER
9. CHECK ENGINE
10. BOOST TEMP. HIGH
11. CHECK BREAKER FILTER (option)

Active condition message

1. ENG.PRE HEAT
2. AUTO WARM UP
3. ENG.IDLING
4. POWER UP
5. ENGINE STOP

Language menu

Japanese	Danish
English	Norwegian
Thai	Swedish
Chinese	Finnish
German	Turkish
French	Arabic
Italian	Malay
Spanish	Indonesian
Portuguese	(Pictograph)
Dutch	

Flow Setting in 10 Patterns and Switching of Combined Circuit

The switch panel in the cab permits setting the flow rate for work with a maximum of ten different special attachments in advance. A circuit change for the breaker and crusher is also possible in the cab.



Fluid Filled Cab Mounts

Four fluid cab mounts reduce vibration and impact transmitted to the cabin, and improve the operators' sitting quality and reduce operator fatigue.

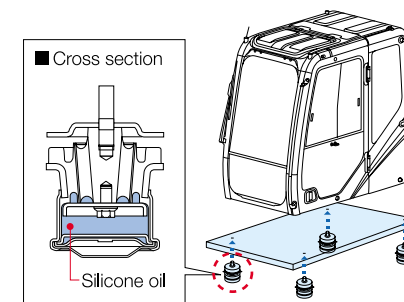

Automatic Air Conditioner with Round Outlets for Increased Comfort

The air outlets of the air conditioner are provided with round grills with wide adjusting angles. The efficiency of the air conditioner has been increased by pressurizing the cab to make it airtight, providing a comfortable space.



ISO-compliant Pressurized Cab to Prevent Dust Entry

The sealed and pressurized (sealing by pressure) cab prevents entry of dust from outside.

Convenient One-touch Muting of AM/FM Radio

SUMITOMO unique design

An AM/FM radio is provided as standard equipment. The mute switch on the left lever permits one-touch muting of the radio.



Low Operation Noise

* The ambient noise level is reduced by 3 dB, while the noise level inside the cab is reduced by approx. 4 dB. Reduction in the ambient noise by 3 dB achieves an effect equivalent to reduction in the sound sources by half.

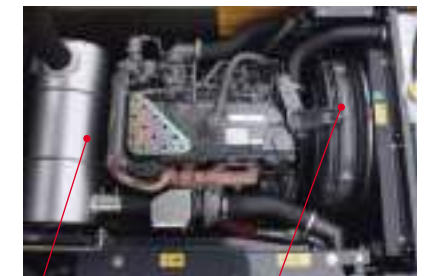

Adoption of large muffler

Reduced fan speed and the bell-mouthed fan guide ensures a noise level far below the standard level.

The wide view increases the safety of work

SUMITOMO unique design

In addition to the wide front view, the down-right view is also made larger to enhance the safety of work.



Anti-theft Alarm System

SUMITOMO's unique anti-theft system can be activated by your SUMITOMO distributors at the time of purchase.



Anti-theft alarm system

Safety Equipment in case of an Emergency



Emergency stop switch

New Gate Lock Lever and Console Tilt-up Function

The console tilt-up function permits easy entry and exit.



Safe and Easy Entry into and Exit from the Cab

A large handrail for easy opening/closing of the door and a non-slip plate are installed to permit the operator to get in and out of the cab easily.



Large handrail



New non-slip plate

High-rigidity Cabin

The new cabin structure provides advanced operator protection.

• About **3 times** greater rigidity

* As compared with SH200-3

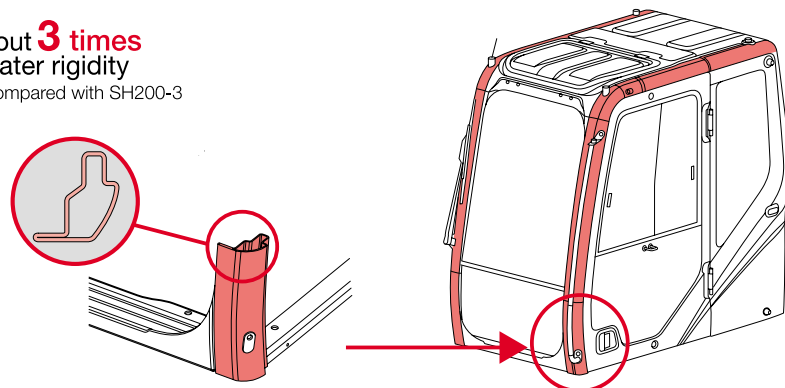

Easy Access to the Upper Structure

A large step and handrail, as well as a non-slip place, minimize the effort when climbing on and off the upper structure.



Front-right large step



Non-slip plate



ISO-compliant large handrail

SUMITOMO's total commitment to product and customer support has enabled it grow into a world renowned manufacturer of hydraulic excavators. Supported by a global sales and service network of over four hundred distributors representing hydraulic excavators manufactured by SUMITOMO, the company supply 70% of total production from Japan to all five continents.

A spread of over one thousand outlets offering excellent parts and service support has global coverage ensuring SUMITOMO hydraulic excavator users have at their disposal Regional Spare Parts Centers, technical repair shops and service vehicles carrying all the necessary equipment to service and repair any hydraulic excavator manufactured by SUMITOMO.

SUMITOMO aims to produce the right products to meet all work applications and at the same time provide the highest level of more training and education to ensure complete product support quality throughout the service network in the world.



Specifications

SH210-5/SH210LC-5 Technical Data Engine

Two variable displacement axial piston pumps, one gear pump for pilot controls and electronic-controlled engine of SPACE5 and SIH:S with New Hydraulic System Includes: three working modes(SP,H,A) one-touch/automatic idling system, automatic power-boost, speed assistance system, power-swing system.

SH210-5/SH210LC-5	
Model	ISUZU AI-4HK1X
Type	Water-cooled,4-cycle,overhead valve, 4-cylinder in line,Direct injection (electric control), turbo-charged diesel engine.
Rated output	117.3 kW ·159.5 PS/1,800 min ⁻¹
Maximum torque	628 N·m at 1,500 min ⁻¹
Piston displacement	5,193 cc
Bore and stroke	115 mm x 125 mm
Starting system	24 V electric motor starting
Alternator	24 V,50 A
Fuel tank	410-liters
Air filter	Double element

Hydraulic pumps

Two variable displacement axial piston pumps provide power for attachment, swing and travel.

SH210-5/SH210LC-5	
Maximum oil flow	2 x 211 liters/min
Pilot pump max.oil flow	18 liters/min

Hydraulic motors

For travel: Two variable displacement axial piston motors.
For swing: One fixed displacement axial piston motor.

Relief valve settings

Boom/arm/bucket ⋯⋯38.7 Mpa(395 kgf/cm²)<Holding pressure>
Boom/arm/bucket ⋯⋯34.3 Mpa(350 kgf/cm²)<Working pressure>
Boom/arm/bucket ⋯⋯36.8 Mpa(375 kgf/cm²)with Power-up<Working pressure>
Swing circuit ⋯⋯⋯29.4 Mpa(300 kgf/cm²)
Travel circuit ⋯⋯⋯34.3 Mpa(350 kgf/cm²)

Control valve

One 4-spool valve and one 5-spool valve with auxiliary spool.

Oil filtration

Return filter ⋯⋯⋯6 microns
Pilot filter ⋯⋯⋯8 microns
Suction filter ⋯⋯⋯105 microns

Hydraulic cylinders

Cylinder	Q'ty	Bore x Rod Diameter x Stroke
Boom	2	120 mm x 85 mm x 1255 mm
Arm	1	140 mm x 100 mm x 1460 mm
Bucket	1	120 mm x 85 mm x 1010 mm

Double-acting, bolt-up type cylinder tube-end;hardened steel bushings Installed in cylinder tube and rods ends.

Cab & Controls

Cab mounted on 4 fluid mountings. Features include safety glass front, rear and side windows, reclining/sliding cloth-upholstered suspension seat with headrest and armrest, cigarette lighter,pop-up skylight window,and intermittent wiper with washer. Front window slides upward for storage and the lower front window is removable. Control levers are located in 4 positions tilting control consoles. Reliable soft-touch switches. Easy-to-read Full-dot LCD monitor keeps operation in touch with critical machine functions.

Swing

Planetary reduction powered by axial piston motor, internal ring gear with Grease cavity for pinion. Swing bearing is single-row shear type ball Bearing. Dual stage relief valves for smooth swing Deceleration and stops. Mechanical disc swing brake.

SH210-5/SH210LC-5	
Swing speed	0~11.5 rpm
Tail swing radius	2,750 mm
Swing torque	61 kN·m · 6,220 kgf·m

Undercarriage

X-style carbody is integrally welded for strength and durability. Grease Cylinder track adjusters with shock absorbing springs. Undercarriage with Lubricated rollers and idlers.

Type of shoe:sealed link shoe

Upper rollers -

Heat treated, mounted on steel bushings with fluorine resin, sealed for lifetime lubrication.

Lower rollers -

Heat treated, mounted on steel bushings with leaded tin bronze casting, sealed for lifetime lubrication.

Track adjustment -

Idler axles adjusted with grease cylinder integral with each side frame;adjustment yoke mechanism fitted with heavy duty recoil spring.

Number of rollers and shoes on each side

Figures in ():LC type

SH210-5/SH210LC-5	
Upper rollers	2
Lower rollers	7(8)
Track shoes	46(49)

Travel System

Two-speed independent hydrostatic system with compact axial motors for Increased performance. Hydraulic motor powered output shaft coupled to a planetary reduction unit and track sprocket. All hydraulic components mounted within the width of side frame. Travel speed can be selected by switch panel. Hydraulically released disc parking brake is built each motor.

SH210-5/SH210LC-5		
Travel speed	High	5.6 km/h
	Low	3.4 km/h
Maximum traction force	201 kN · 20,496 kgf	

Lubricant & Coolant Capacity

SH210-5/SH210LC-5	
Hydraulic system	240 liters
Hydraulic oil tank	147 liters
Fuel tank	410 liters
Cooling system	25.6 liters
Final drive case(per side)	5.0 liters
Swing drive case	5.0 liters
Engine crank case (with remote oil filter)	23 liters

Auxiliary hydraulic system

SH210-5/SH210LC-5			
Auxiliary piping type (option)	For Breaker	For Double (breaker & crusher) acting	For D/A + Second option line
Arm type	STD	STD	HD
Bucket linkage type	HD	HD	HD
Maximum Auxiliary line flow	210 liters/min	420 liters/min	420+60 liters/min

Bucket

Model	SH210-5								
Bucket capacity (ISO/SAE/PCSA heaped)	0.50 m ³	0.80 m ³	0.80 m ³	0.80 m ³	0.90 m ³	0.90 m ³	1.00 m ³	1.00 m ³	1.10 m ³
Bucket capacity (CECE heaped)	0.45 m ³	0.70 m ³	0.70 m ³	0.70 m ³	0.80 m ³	0.80 m ³	0.90 m ³	0.90 m ³	1.00 m ³
Bucket type	STD	STD	Heavy duty	Level-pin	STD	Level-pin	STD	Level-pin	STD
Number of teeth	3	5	5	5	5	5	6	6	6
Width unit:mm	With side cutter								
	830	1 130	1 136	1 130	1 230	1 230	1 360	1 360	1 460
	Without side cutter								
	730	1 030	1 036	1 030	1 130	1 130	1 260	1 260	1 360
Weight unit:kg	523	654	736	639	694	674	747	729	780
Combination	1.90 m arm	●	●	●	●	●	◎	◎	△
	2.40 m arm	●	●	●	●	◎	◎	△	△
	2.94 m arm	●	◎	◎	◎	△	△	△	△

Model	SH210LC-5								
Bucket capacity (ISO/SAE/PCSA heaped)	0.50 m ³	0.80 m ³	0.80 m ³	0.80 m ³	0.90 m ³	0.90 m ³	1.00 m ³	1.00 m ³	1.10 m ³
Bucket capacity (CECE heaped)	0.45 m ³	0.70 m ³	0.70 m ³	0.70 m ³	0.80 m ³	0.80 m ³	0.90 m ³	0.90 m ³	1.00 m ³
Bucket type	STD	STD	Heavy duty	Level-pin	STD	Level-pin	STD	Level-pin	STD
Number of teeth	3	5	5	5	5	5	6	6	6
Width unit:mm	With side cutter								
	830	1 130	1 136	1 130	1 230	1 230	1 360	1 360	1 460
	Without side cutter								
	730	1 030	1 036	1 030	1 130	1 130	1 260	1 260	1 360
Weight unit:kg	523	654	736	639	694	674	747	729	780
Combination	1.90 m arm	●	●	●	●	●	●	◎	◎
	2.40 m arm	●	●	●	●	●	◎	◎	△
	2.94 m arm	●	●	●	●	◎	◎	△	△

◎ Standard bucket (Suitable for materials with density up to 1,800 kg/m³ or less)

○ Suitable for materials with density up to 1,600 kg/m³ or less

● Suitable for materials with density up to 2,000 kg/m³ or less

△ Suitable for materials with density up to 1,200 kg/m³ or less

Weight & Ground Pressure

Model	SH210-5			
Shoe type	Shoe width	Overall width	Operating weight	Ground pressure
Triple grouser shoe	600 mm	2 800 mm	20 000 kg	45 kPa
	700 mm	2 900 mm	20 400 kg	39 kPa
	800 mm	3 000 mm	20 700 kg	35 kPa

Model	SH210LC-5			
Shoe type	Shoe width	Overall width	Operating weight	Ground pressure
Triple grouser shoe	600 mm	2 990 mm	20 400 kg	42 kPa
	700 mm	3 090 mm	20 900 kg	37 kPa
	800 mm	3 190 mm	21 200 kg	33 kPa

Digging Force

Model	SH210-5/SH210LC-5		
Arm length	1.90 m	2.40 m	2.94 m
Bucket digging force	ISO 6015	142 kN (152 kN)	142 kN (152 kN)
	SAE: PCSA	127 kN (136 kN)	127 kN (136 kN)
Arm digging force	ISO 6015	142 kN (152 kN)	123 kN (132 kN)
	SAE: PCSA	136 kN (146 kN)	119 kN (127 kN)

Lifting Capacity

- Notes: 1. Ratings are based on SAE J/ISO 10567
- 2. Lifting capacity does not exceed 75% of tipping load with the machine on firm, level ground or 87% full hydraulic capacity.
- 3. The load point is a hook (not standard equipment) located on the back of the bucket.
- 4. *Indicates load limited by hydraulic capacity.
- 5. 0m = Ground.

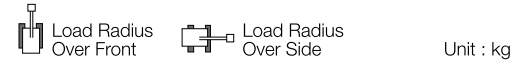

SH210-5 SHOES : 600 (mm)G BUCKET : SAE/PCSA 0,8 (m³) ARM LENGTH = 2,94 (m) MAXIMUM REACH = 8,56 (m) BOOM : 5,70 (m)

Bucket Hook Height	Radius of Load																							
	Max. Radius		8 m		7 m		6 m		5 m		4 m		3 m		2 m		Min. Radius							
	Front	Side	Front	Side	Front	Side	Front	Side	Front	Side	Front	Side	Front	Side	Front	Side	Front	Side						
7 m	2 744*	6,79	2 744*	6,79															3 964*	6,25	3 928	6,25		
6 m	2 675*	7,46	2 675*	7,46			3 889*	3 125											4 060*	6,15	3 988	6,15		
5 m	2 674*	7,94	2 376	7,94			4 276*	3 056	4 362*	4 051									4 397*	5,73	4 394	5,73		
4 m	2 730*	8,27	2 131	8,27	3 642	2 284	4 561*	2 950	4 843*	3 876	5 293*	5 277							5 435*	4,76	5 435*	4,76		
3 m	2 842*	8,48	1 970	8,48	3 560	2 209	4 486	2 823	5 433*	3 673	6 243*	4 943	7 660*	7 054	10 612*	10 612*			6 688*	2,21	6 688*	2,21		
2 m	3 017*	8,56	1 873	8,56	3 472	2 127	4 342	2 691	5 591	3 468	7 221*	4 612	9 297*	6 473	10 692*	10 068			4 374*	2,51	4 374*	2,51		
1 m	3 054	8,52	1 833	8,52	3 389	2 050	4 210	2 571	5 388	3 286	7 229	4 335	8 236*	6 042	8 236*	8 236*			3 784*	2,37	3 784*	2,37		
0 m	3 100	8,36	1 848	8,36	3 324	1 990	4 105	2 474	5 232	3 146	7 003	4 139	10 245	5 788	9 054*	9 054*	4 906*	4 906*	5 648*	2,00	5 648*	2,00		
-1 m	3 241	8,08	1 927	8,08	3 287	1 956	4 035	2 411	5 130	3 055	6 870	4 023	10 098	5 667	10 929*	9 174	7 346*	7 346*	6 791*	1,69	7 224*	1,47		
-2 m	3 513	7,65	2 092	7,65			4 009	2 386	5 084	3 014	6 817	3 977	10 064	5 640	13 437*	9 213	9 760*	9 760*	9 128*	1,69	8 496*	1,19		
-3 m	3 996	7,05	2 389	7,05			4 039	2 414	5 098	3 026	6 836	3 994	10 119	5 685	14 511*	9 327	12 404*	12 404*	11 629*	1,69	10 757*	1,19		
-4 m	4 894	6,24	2 939	6,24					5 187	3 106	6 932	4 077	10 186*	5 802	13 129*	9 526	15 479*	15 479*	14 469*	1,69	13 274*	1,19		
-5 m	6 582*	5,10	4 132	5,10											6 761*	4 257	8 605*	6 014	10 983*	9 841	14 290*	2,09	14 290*	2,09

- Notes: 1. Ratings are based on SAE J/ISO 10567
- 2. Lifting capacity does not exceed 75% of tipping load with the machine on firm, level ground or 87% full hydraulic capacity.
- 3. The load point is a hook (not standard equipment) located on the back of the bucket.
- 4. *Indicates load limited by hydraulic capacity.
- 5. 0m = Ground.

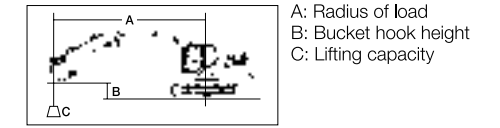

SH210LC-5 SHOES : 600 (mm)G BUCKET : SAE/PCSA 0,9 (m³) ARM LENGTH = 2,94 (m) MAXIMUM REACH = 8,56 (m) BOOM : 5,70 (m)

Bucket Hook Height	Radius of Load																									
	Max. Radius		8 m		7 m		6 m		5 m		4 m		3 m		2 m		Min. Radius									
	Front	Side	Front	Side	Front	Side	Front	Side	Front	Side	Front	Side	Front	Side	Front	Side	Front	Side								
7 m	2 715*	6,79	2 715*	6,79																			3 936*	6,25	3 936*	6,25
6 m	2 647*	7,46	2 647*	7,46					3 861*	3 473										4 029*	6,15	4 029*	6,15			
5 m	2 646*	7,94	2 646*	7,94					4 244*	3 403										4 366*	5,73	4 366*	5,73			
4 m	2 702*	8,27	2 396	8,27	3 717*	2 564	4 529*	3 295	4 811*	4 319	5 262*	5 262*								5 403*	4,76	5 403*	4,76			
3 m	2 814*	8,48	2 225	8,48	4 066	2 488	4 899*	3 165	5 401*	4 111	6 211*	5 537	7 627*	7 627*	10 577*	10 577*			6 659*	2,21	6 659*	2,21				
2 m	2 989*	8,56	2 124	8,56	3 976	2 404	4 973	3 031	6 022*	3 901	7 188*	5 197	9 262*	7 348	10 663*	10 663*			4 346*	2,51	4 346*	2,51				
1 m	3 244*	8,52	2 084	8,52	3 891	2 326	4 837	2 908	6 213	3 715	8 037*	4 913	10 533*	6 901	8 207*	8 207*			3 756*	2,37	3 756*	2,37				
0 m	3 566	8,36	2 106	8,36	3 824	2 265	4 729	2 810	6 050	3 571	8 169	4 711	11 292*	6 636	9 025*	9 025*	4 877*	4 877*	5 620*	2,00	5 620*	2,00				
-1 m	3 733	8,08	2 198	8,08	3 786	2 230	4 657	2 745	5 944	3 478	8 029	4 591	11 591*	6 511	10 900*	10 717	7 317*	7 317*	6 989*	1,83	7 196*	1,47				
-2 m	4 050	7,65	2 385	7,65			4 630	2 720	5 897	3 436	7 973	4 544	11 507*	6 483	13 408*	10 759	9 731*	9 731*	9 367*	1,83	8 556*	1,28				
-3 m	4 611	7,05	2 720	7,05			4 660	2 748	5 912	3 449	7 994	4 562	11 052*	6 530	14 472*	10 881	12 375*	12 375*	11 934*	1,83	10 865*	1,28				
-4 m	5 656	6,24	3 340	6,24					6 004	3 531	8 094	4 647	10 151*	6 652	13 091*	11 092	15 450*	15 450*	14 878*	1,83	13 440*	1,28				
-5 m	6 548*	5,10	4 689	5,10									6 728*	4 833	8 570*	6 872	10 947*	10 947*				14 250*	2,09	14 250*	2,09	

SH210-5 SHOES : 600 (mm)G BUCKET : SAE/PCSA 0,9 (m³) ARM LENGTH = 2,40 (m) MAXIMUM REACH = 8,14 (m) BOOM : 5,70 (m)

Bucket Hook Height	Radius of Load																						
	Max. Radius		8 m		7 m		6 m		5 m		4 m		3 m		2 m		Min. Radius						
	Front	Side	Front	Side	Front	Side	Front	Side	Front	Side	Front	Side	Front	Side	Front	Side	Front	Side					
7 m	4 016*	6,25	3 800	6,25					4 466*	4 117									4 427*	5,78	4 421	5,78	
6 m	3 925*	6,97	3 057	6,97					4 497*	4 078										4 503*	5,67	4 503*	5,67
5 m	3 939*	7,49	2 609	7,49			4 636*	2 982	4 781*	3 960									5 005*	5,16	5 005*	5,16	
4 m	3 718	7,84	2 321	7,84			4 557	2 887	5 238*	3 789	5 831*	5 141	6 847*	6 847*					7 342*	3,67	7 342*	3,67	
3 m	3 473	8,05	2 138	8,05	3 514	2 166	4 427	2 769	5 731	3 593	6 750*	4 810	8 472*	6 798	12 366*	10 597			11 260*	2,90	11 160	2,90	
2 m	3 341	8,14	2 031	8,14	3 440	2 097	4 295	2 647	5 515	3 399	7 414	4 494	9 992*	6 248					7 488*	3,13	7 488*	3,13	
1 m	3 306	8,10	1 991	8,10	3 372	2 033	4 177	2 540	5 331	3 234	7 128	4 246	10 365	5 885					6 110*	3,02	6 110*	3,02	
0 m	3 369	7,93	2 017	7,93			4 089	2 459	5 197	3 114	6 941	4 083	10 142	5 702	8 256*	8 256*			5 726*	2,53	5 726*	2,53	
-1 m	3 550	7,63	2 121	7,63			4 040	2 414	5 120	3 045	6 845	4 001	10 065	5 638	11 208*	9 187	7 576*	7 576*	8 082*	1,79	8 082*	1,79	
-2 m	3 899	7,17	2 333	7,17			4 041	2 415	5 103	3 029	6 829	3 986	10 084	5 654	14 733*	9 274	10 815*	10 815*	10 188*	1,69	9 639*	1,19	
-3 m	4 537	6,53	2 723	6,53					5 152	3 073	6 887	4 036	10 187	5 739	13 709*	9 432	14 321*	14 321*	13 468*	1,69	12 646*	1,26	
-4 m	5 806	5,64	3 489	5,64						7 033	4 164	9 530*	5 902	12 065*	9 683	16 013*	16 013*	17 516*	1,74	17 516*	1,74		
-5 m	6 815*	4,35	5 427	4,35											7 471*	6 190			9 292*	3,08	9 292*	3,08	

SH210LC-5 SHOES : 600 (mm)G BUCKET : SAE/PCSA 1,0 (m³) ARM LENGTH = 2,40 (m) MAXIMUM REACH = 8,14 (m) BOOM : 5,70 (m)

Bucket Hook Height	Radius of Load																								
	Max. Radius		8 m		7 m		6 m		5 m		4 m		3 m		2 m		Min. Radius								
	Front	Side	Front	Side	Front	Side	Front	Side	Front	Side	Front	Side	Front	Side	Front	Side	Front	Side							
7 m	3 980*	6,25	3 980*	6,25							4 425*	4 425*										4 386*	5,78	4 386*	5,78
6 m	3 889*	6,97	3 397	6,97							4 456*	4 456*								4 463*	5,67	4 463*	5,67		
5 m	3 903*	7,49	2 911	7,49							4 594*	3 319	4 740*	4 396						4 965*	5,16	4 965*	5,16		
4 m	4 002*	7,84	2 601	7,84							4 841*	3 222	5 196*	4 222	5 790*	5 734	6 805*	6 805*		7 301*	3,67	7 301*	3,67		
3 m	3 964	8,05	2 405	8,05	4 011	2 435	5 053	3 102	5 754*	4 021	6 707*	5 393	8 428*	7 677	12 318*	12 214			11 220*	2,90	11 220*	2,90			
2 m	3 822	8,14	2 293	8,14	3 935	2 365	4 916	2 978	6 327*	3 822	7 616*	5 068	9 945*	7 105					7 450*	3,13	7 450*	3,13			
1 m	3 789	8,10	2 254	8,10	3 865	2 301	4 795	2 868	6 145	3 653	8 290	4 812	10 990*	6 728					6 073*	3,02	6 073*	3,02			
0 m	3 868	7,93	2 287	7,93			4 704	2 786	6 006	3 530	8 094	4 644	11 494*	6 537	8 218*	8 218*			5 690*	2,53	5 690*	2,53			
-1 m	4 082	7,63	2 407	7,63			4 653	2 740	5 926	3 460	7 994	4 559	11 570*	6 471	11 171*	10 719	7 540*	7 540*	7 239*	1,83	8 045*	1,19			
-2 m	4 488	7,17	2 647	7,17					4 655	2 741	5 908	3 444	7 977	4 545	11 291*	6 488	14 695*	10 812	10 779*	10 779*	10 412*	1,83	9 668*	1,28	
-3 m	5 231	6,53	3 087	6,53							5 959	3 489	8 038	4 597	10 639*	6 577	13 658*	10 980	14 284*	14 284*	13 795*	1,83	12 647*	1,28	
-4 m	6 532*	5,64	3 951	5,64									7 596*	4 728	9 484*	6 747	12 015*	11 248	15 959*	15 959*	16 913*	1,83	17 478*	1,74	
-5 m	6 771*	4,35																							

Lifting Capacity

Notes: 1. Ratings are based on SAE J/ISO 10567

- 2. Lifting capacity does not exceed 75% of tipping load with the machine on firm, level ground or 87% full hydraulic capacity.
- 3. The load point is a hook (not standard equipment) located on the back of the bucket.
- 4. *Indicates load limited by hydraulic capacity.
- 5. 0m = Ground.

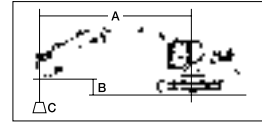

A: Radius of load
B: Bucket hook height
C: Lifting capacity



Unit : kg

SH210-5 SHOЕ : 800 (mm)G ARM LENGTH = 2.94 (m) BOOM : 5.70 (m)
BUCKET : SAE/PCSA 0.8 (m³) MAXIMUM REACH = 8.56 (m)

Bucket Hook Height	Max. Radius		8 m		7 m		6 m		5 m		4 m		3 m		2 m		Min. Radius									
	Hook	Side	Hook	Side	Hook	Side	Hook	Side	Hook	Side	Hook	Side	Hook	Side	Hook	Side	Hook	Side								
7 m	2 744*	6.79	2 744*	6.79														3 964*	6.25	3 964*	6.25					
6 m	2 675*	7.46	2 675*	7.46			3 889*	3 231										4 060*	6.15	4 060*	6.15					
5 m	2 674*	7.94	2 468	7.94			4 276*	3 163	4 362*	4 180								4 397*	5.73	4 397*	5.73					
4 m	2 730*	8.27	2 218	8.27	3 745*	2 375	4 561*	3 057	4 843*	4 005	5 293*	5 293*						5 435*	4.76	5 435*	4.76					
3 m	2 842*	8.48	2 055	8.48	3 700	2 300	4 652	2 929	5 433*	3 802	6 243*	5 105	7 660*	7 275	10 612*	10 612*		6 688*	2.21	6 688*	2.21					
2 m	3 017*	8.56	1 958	8.56	3 611	2 218	4 508	2 798	5 795	3 597	7 221*	4 775	9 297*	6 694	10 692*	10 410		4 374*	2.51	4 374*	2.51					
1 m	3 183	8.52	1 918	8.52	3 529	2 141	4 376	2 677	5 593	3 415	7 495	4 498	10 569*	6 263	8 236*	8 236*		3 784*	2.37	3 784*	2.37					
0 m	3 232	8.36	1 935	8.36	3 464	2 081	4 271	2 581	5 436	3 275	7 269	4 302	10 625	6 008	9 054*	9 054*	4 906*	4 906*	5 648*	2.00	5 648*	2.00				
-1 m	3 379	8.08	2 018	8.08	3 426	2 047	4 201	2 517	5 334	3 183	7 136	4 186	10 479	5 888	10 929*	9 516	7 346*	7 346*	6 791*	1.69	7 224*	1.47				
-2 m	3 661	7.65	2 188	7.65			4 174	2 493	5 289	3 143	7 083	4 140	10 445	5 860	13 437*	9 555	9 760*	9 760*	9 128*	1.69	8 496*	1.19				
-3 m	4 161	7.05	2 495	7.05			4 204	2 520	5 302	3 155	7 102	4 156	10 500	5 905	14 511*	9 669	12 404*	12 404*	11 629*	1.69	10 757*	1.19				
-4 m	5 087	6.24	3 062	6.24					5 391	3 234	7 197	4 239	10 186*	6 022	13 129*	9 868	15 479*	15 479*	14 469*	1.69	13 274*	1.19				
-5 m	6 582*	5.10	4 291	5.10													6 761*	4 420	8 605*	6 234	10 983*	10 183	14 290*	2.09	14 290*	2.09

SH210-5 SHOЕ : 800 (mm)G ARM LENGTH = 2.40 (m) BOOM : 5.70 (m)
BUCKET : SAE/PCSA 0.9 (m³) MAXIMUM REACH = 8.14 (m)

Bucket Hook Height	Max. Radius		8 m		7 m		6 m		5 m		4 m		3 m		2 m		Min. Radius							
	Hook	Side	Hook	Side	Hook	Side	Hook	Side	Hook	Side	Hook	Side	Hook	Side	Hook	Side	Hook	Side						
7 m	4 016*	6.25	3 923	6.25															4 427*	5.78	4 427*	5.78		
6 m	3 925*	6.97	3 164	6.97					4 466*	4 246									4 503*	5.67	4 503*	5.67		
5 m	3 939*	7.49	2 707	7.49					4 636*	3 089	4 781*	4 089							5 005*	5.16	5 005*	5.16		
4 m	3 861	7.84	2 415	7.84					4 722	2 993	5 238*	3 918	5 831*	5 304	6 847*	6 847*			7 342*	3.67	7 342*	3.67		
3 m	3 611	8.05	2 228	8.05	3 654	2 257	4 593	2 875	5 796*	3 722	6 750*	4 972	8 472*	7 019	12 366*	10 939			11 260*	2.90	11 260*	2.90		
2 m	3 477	8.14	2 121	8.14	3 579	2 188	4 461	2 754	5 719	3 528	7 660*	4 657	9 992*	6 469					7 488*	3.13	7 488*	3.13		
1 m	3 443	8.10	2 081	8.10	3 511	2 124	4 343	2 647	5 535	3 363	7 393	4 408	10 746	6 106					6 110*	3.02	6 110*	3.02		
0 m	3 510	7.93	2 109	7.93			4 255	2 566	5 401	3 243	7 206	4 246	10 523	5 923	8 256*	8 256*	5 726*	2.53	5 726*	2.53	5 726*	2.53		
-1 m	3 698	7.63	2 217	7.63			4 205	2 521	5 324	3 174	7 111	4 163	10 445	5 858	11 208*	9 529	7 576*	7 576*	8 082*	1.79	8 082*	1.79		
-2 m	4 060	7.17	2 436	7.17			4 206	2 522	5 307	3 158	7 095	4 149	10 465	5 875	14 733*	9 616	10 815*	10 815*	10 188*	1.69	9 639*	1.19		
-3 m	4 719	6.53	2 839	6.53					5 356	3 202	7 152	4 199	10 568	5 960	13 709*	9 774	14 321*	14 321*	13 468*	1.69	12 646*	1.26		
-4 m	6 029	5.64	3 628	5.64							7 299	4 326	9 530*	6 122	12 065*	10 025	16 013*	16 013*	17 516*	1.74	17 516*	1.74		
-5 m	6 815*	4.35	5 622	4.35													7 471*	6 411			9 292*	3.08	9 292*	3.08

SH210-5 SHOЕ : 800 (mm)G ARM LENGTH = 1.91 (m) BOOM : 5.70 (m)
BUCKET : SAE/PCSA 1.0 (m³) MAXIMUM REACH = 7.66 (m)

Bucket Hook Height	Max. Radius		8 m		7 m		6 m		5 m		4 m		3 m		2 m		Min. Radius							
	Hook	Side	Hook	Side	Hook	Side	Hook	Side	Hook	Side	Hook	Side	Hook	Side	Hook	Side	Hook	Side						
7 m	4 997*	5.61	4 688	5.61															4 959*	5.30	4 959*	5.30		
6 m	4 910*	6.40	3 650	6.40					4 989*	4 126									5 081*	5.17	5 081*	5.17		
5 m	4 812	6.96	3 067	6.96					5 229*	4 025	5 624*	5 491							5 913*	4.51	5 913*	4.51		
4 m	4 306	7.34	2 709	7.34					4 683	2 960	5 656*	3 865	6 386*	5 201	7 698*	7 416	10 571*	10 571*	12 406*	2.70	12 406*	2.70		
3 m	4 004	7.57	2 488	7.57					4 570	2 857	5 885	3 680	7 271*	4 879	9 319*	6 795			10 419*	3.28	8 986	3.28		
2 m	3 848	7.66	2 365	7.66					4 453	2 750	5 686	3 502	7 594	4 587	10 698*	6 296			8 141*	3.48	7 609	3.48		
1 m	3 816	7.62	2 326	7.62					4 353	2 658	5 525	3 357	7 348	4 374	10 638	6 024			7 230*	3.39	7 230*	3.39		
0 m	3 909	7.44	2 370	7.44					4 285	2 596	5 417	3 260	7 205	4 249	10 512	5 920	7 498*	7 498*	7 125*	2.96	7 125*	2.96		
-1 m	4 160	7.12	2 515	7.12					4 261	2 575	5 368	3 217	7 151	4 202	10 501	5 910	12 123*	9 691	10 061*	2.27	10 061*	2.27		
-2 m	4 647	6.63	2 809	6.63							5 382	3 229	7 172	4 221	10 570	5 967	14 002*	9 794	12 697*	12 697*	12 138*	1.69	12 095*	1.65
-3 m	5 580	5.93	3 372	5.93									7 271	4 307	10 211*	6 090	12 769*	9 982	16 311*	16 311*	16 313*	1.75	16 312*	1.75
-4 m	7 073*	4.93	4 591	4.93											8 743*	6 305	10 846*	10 285			12 496*	2.37	12 496*	2.37

Notes: 1. Ratings are based on SAE J/ISO 10567

- 2. Lifting capacity does not exceed 75% of tipping load with the machine on firm, level ground or 87% full hydraulic capacity.
- 3. The load point is a hook (not standard equipment) located on the back of the bucket.
- 4. *Indicates load limited by hydraulic capacity.
- 5. 0m = Ground.

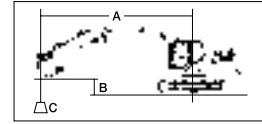

A: Radius of load
B: Bucket hook height
C: Lifting capacity



Unit : kg

SH210LC-5 SHOЕ : 800 (mm)G ARM LENGTH = 2.94 (m) BOOM : 5.70 (m)
BUCKET : SAE/PCSA 0.9 (m³) MAXIMUM REACH = 8.56 (m)

Bucket Hook Height	Max. Radius		8 m		7 m		6 m		5 m		4 m		3 m		2 m		Min. Radius								
	Hook	Side	Hook	Side	Hook	Side	Hook	Side	Hook	Side	Hook	Side	Hook	Side	Hook	Side	Hook	Side							
7 m	2 715*	6.79	2 715*	6.79																		3 936*	6.25	3 936*	6.25
6 m	2 647*	7.46	2 647*	7.46					3 861*	3 597									4 029*	6.15	4 029*	6.15			
5 m	2 646*	7.94	2 646*	7.94					4 244*	3 528					4 331*	4 331*			4 366*	5.73	4 366*	5.73			
4 m	2 702*	8.27	2 498	8.27	3 717*	2 670	4 529*	3 419	4 811*	4 469	5 262*	5 262*							5 403*	4.76	5 403*	4.76			
3 m	2 814*	8.48	2 324	8.48	4 231	2 594	4 899*	3 289	5 401*	4 262	6 211*	5 729	7 627*	7 627*	10 577*	10 577*			6 659*	2.21	6 659*	2.21			
2 m	2 989*	8.56	2 222	8.56	4 140	2 510	5 169	3 155	6 022*	4 052	7 188*	5 389	9 262*	7 610	10 663*	10 663*			4 346*	2.51	4 346*	2.51			
1 m	3 244*	8.52	2 183	8.52	4 056	2 432	5 034	3 033	6 457	3 866	8														

Principle Specifications

	SH210-5	SH210LC-5
	STD Specifications	
Boom length	5.70 m	
Arm length	2.94 m	
Bucket capacity (ISO heaped)	0.80 m ³	0.90 m ³
Std. operating weight	20 000 kg	20 400 kg
Make & model	ISUZU AI-4HK1X	
Rated output	117.3 kw/1 800 min ⁻¹	
Displacement	5 193 ml(cc)	
Main pump	2 variable displacement axial piston pumps with regulating system	
Max pressure	34.3 Mpa	
(with auto power boost)	36.8 Mpa	
Travel motor	Variable displacement axial piston motor	
Parking brake type	Mechanical lock brake	
Swing motor	Fixed displacement axial piston motor	
Travel speed	5.6/3.4 km/h	
Traction force	201 kN (20,496 kgf)	
Grade ability	70% <35°>	
Ground pressure	45 kPa	42 kPa
Swing speed	11.5 min ⁻¹	
Bucket	142 kN	
/with power boost	152 kN	
Arm	103 kN	
/with power boost	110 kN	
Fuel tank	410 liters	
Hydraulic fluid tank	240 liters	

Standard equipment

[Hydraulic system]

- SIH-S hydraulic system
- Operation mode (SP, H and A mode)
- Auto/one-touch idling
- Automatic 2-speed travel
- Automatic power boost
- Arm/boom/bucket reactivation circuit
- Automatic swing parking system
- High-performance return filter

[Cab/interior equipment]

- Tilting console
- Open air introducing pressurized full-automatic air conditioner
- Defroster
- Hot & cool box
- Water-repelling operator's seat
- Seat suspension
- Rise-up wiper (with intermittent operation function)
- Cup holder
- AM/FM radio (with muting function)
- Clock
- Magazine rack
- Accessory case
- Floor mat
- Armrest & headrest
- Ashtray & cigar lighter
- Room light (Auto-OFF function)
- Coat hook

[Safety equipment]

- Rearview mirror (left/right)
- Emergency escape tool
- Winding seat belt
- Gate lock lever
- Travel alarm (with on and off switch)
- Anti-theft alarm system
- Engine room firewall
- Fan guard
- Engine emergency stop switch

[Others]

- EMS
- Long-life hydraulic oil
- Two lights (main unit and left of arm)
- Fuel filter (with water separator)
- Fuel prefilter (with water separator)
- Double-element air cleaner
- Grease-enclosed track link
- Bucket rattling control mechanism
- Large tool box
- A set of tools

Accessories (option)

■ Cab-top light



■ Rain reflector



■ 12V power (DC-DC converter)



■ Head guard (FOPS level 2)



■ Polycarbonate with sunshade roof top window



■ Air suspension (KAB seat)



■ Rear view camera and monitor



Working Range

	SH210-5/SH210LC-5		
Arm length	1.90 m	2.40 m	2.94 m
Boom length	5.70 m		
A Max digging radius	8 960 mm	9 420 mm	9 900 mm
B Max digging depth	5 610 mm	6 110 mm	6 650 mm
C Max digging height	9 160 mm	9 410 mm	9 610 mm
D Max dumping height	6 330 mm	6 590 mm	6 810 mm
E Max vertical wall cut depth	5 010 mm	5 500 mm	5 960 mm
F Min. front swing radius	3 580 mm	3 600 mm	3 600 mm
G Rear end swing radius	2 750 mm		

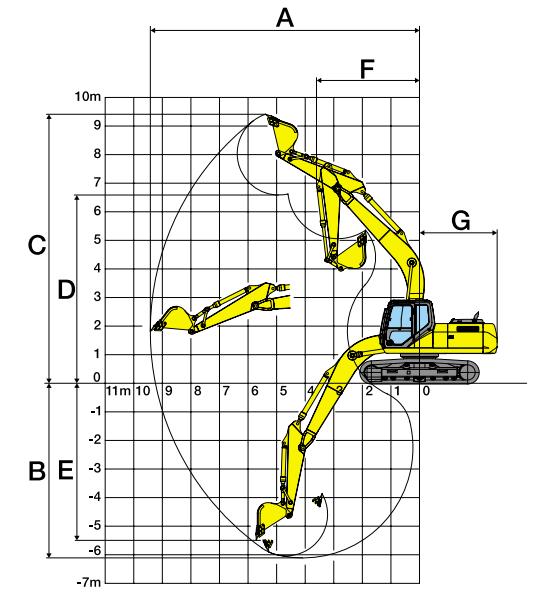

Dimensions

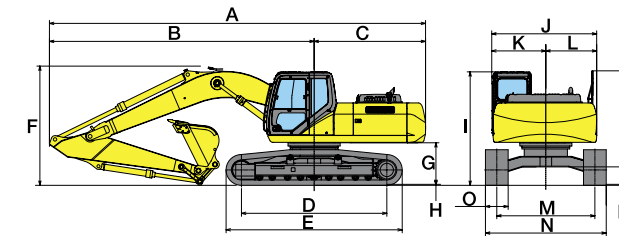

Model	SH210-5 (SH210LC-5)		
Arm length	1.90 m	2.40 m	2.94 m
A Overall length	9 490 mm	9 480 mm	9 400 mm
B Length from center of machine (to arm top)	6 770 mm	6 760 mm	6 680 mm
C Upper structure rear end radius	2 720 mm	2 720 mm	2 720 mm
D Center to center of wheels	3 370 mm (3 660 mm)	3 370 mm (3 660 mm)	3 370 mm (3 660 mm)
E Overall track length	4 180 mm (4 470 mm)	4 180 mm (4 470 mm)	4 180 mm (4 470 mm)
F Overall height	3 090 mm	3 190 mm	2 970 mm
G Clearance height under upper structure	1 040 mm	1 040 mm	1 040 mm
H Shoe lug height	26 mm	26 mm	26 mm
I Cab height	2 940 mm	2 940 mm	2 940 mm
J Upper structure overall width	2 770 mm	2 770 mm	2 770 mm
K Width from center of machine (left side)	1 430 mm	1 430 mm	1 430 mm
L Width from center of machine (right side)	1 340 mm	1 340 mm	1 340 mm
M Track gauge	2 200 mm (2 390 mm)	2 200 mm (2 390 mm)	2 200 mm (2 390 mm)
N Overall width	2 800 mm (2 990 mm)	2 800 mm (2 990 mm)	2 800 mm (2 990 mm)
O Std. Shoe width	600 mm	600 mm	600 mm
P Minimum ground clearance	440 mm	440 mm	440 mm
Q Handrail height	2 960 mm	2 960 mm	2 960 mm