

TYM

OPERATOR'S MANUAL

FOR

TRACTORS

T354



BYUCKSAN GROUP
TONGYANG MOOLSAN CO., LTD.

YANMAR

WARRANTIES

YANMAR LIMITED WARRANTY

What is Covered by this Warranty?

YANMAR warrants to the original retail purchaser that a new YANMAR TNV common rail series industrial engine will be free from defects in material and/or workmanship for the duration of the warranty period.

Note: YANMAR engines may be equipped with external components including, but not limited to: wiring harnesses, electrical devices, control panels, radiator, air filters, fuel/or exhaust systems that are supplied and/or installed by manufacturers other than YANMAR. For warranty information on such external components, please contact the machine or component manufacturer directly or see your authorized YANMAR dealer or distributor.

This warranty is provided in lieu of all other warranties, express or implied. YANMAR specifically disclaims any implied warranties of merchantability or fitness for a particular purpose, except where such disclaimer is prohibited by law. If such disclaimer is prohibited by law, then implied warranties shall be limited in duration to the life of the express warranty.

How Long is the Warranty Period?

The YANMAR standard limited warranty period runs for a period of **twenty-four (24) months or Two-thousand(2000) engine operation hours**, whichever occurs first. An extended limited warranty of thirty-six(36) months or three thousand(3000) engine operating hours, whichever occurs first, is provided for these specific parts only: the cylinder block, cylinder head, crankshaft forging, connecting rods, flywheel, flywheel housing, camshaft, timing gear, and gear case. The warranty period for both the Standard limited warranty and the extended limited warranty (by duration or operation hours) begins on the date of delivery to the original retail purchaser and is valid only until the applicable warranted duration has passed or the operation hours are exceeded, whichever comes first.

YANMAR limited warranty- continued

What the Engine Owner must Do:

If you believe your YANMAR engine has experienced a failure due to a defect in material and/or workmanship, you must contact an authorized YANMAR industrial engine dealer or distributor within Thirty (30) Days of discovering the failure, You must provide proof of ownership of the engine, proof of the date of the engine purchase and delivery, and documentation of the engine operation hours. Acceptable forms of proof of delivery date include, but are not limited to: the original warranty registration of sales receipts or other documents maintained in the ordinary course of business by YANMAR dealers and/or distributors, indicating the date of delivery of the YANMAR product to the original retail purchaser, This information is necessary to establish whether the YANMAR product is still within the warranty period. Thus, YANMAR strongly recommends you register your engine as soon as possible after purchase in order to facilitate any future warranty matters.

You are responsible for the transportation of the engine to and from the repair location as designated by YANMAR.

To Locate an Authorized YANMAR Industrial Engine Dealer or Distributor:

You can locate your nearest authorized YANMAR industrial engine dealer or distributor by visiting the YANMAR Co., Ltd. Website at:

<http://www.yanmar.co.jp> (The Japanese language page will be displayed.) For English language “click” on “English Page.”)

- “click” on “Network” in the website heading to view the “YANMAR Worldwide Network.”
- Choose and “Click” on the desired product group.
- “Click” on the Icon closest to your region.
- “Click” on the desired country or associate company to locate your nearest authorized YANMAR Industrial engine dealer or distributor.

You may also contact YANMAR by clicking on “Inquiry” in the website heading and typing in your Question or comment.

What YANMAR will DO:

YANMAR warrants to the original retail purchaser of a new YANMAR engine that YANMAR will make such repairs and/or replacements at YANMAR’s option, of any part(s) of the YANMAR product covered by this warranty found to be defective in material and/or workmanship. Such repairs and/or replacements will be made at a location designated by YANMAR at no cost to the purchaser for parts or labor.

YANMAR limited warranty- continued

What is no Covered by this Warranty?

This warranty does not cover parts affected by or damaged by any reason other than defective materials or workmanship, including, but not limited to, accident, misuse, abuse, "Acts of God," neglect, improper installation, improper maintenance, improper storage, the use of unsuitable attachments or parts, the use of contaminated fuels, the use of fuels, oils, lubricants, or fluids other than those recommended in your YANMAR Operation Manual, unauthorized alterations or modifications, ordinary wear and tear, and rust or corrosion. This warranty does not cover the cost of parts and/or labor required to perform normal/scheduled maintenance on your YANMAR engine. This warranty does not cover consumable parts such as, but not limited to, filters, belts, hoses, fuel injector, lubricants and cleaning fluids. This warranty does not cover the cost of shipping the product to or from the warranty repair facility.

Warranty Limitations:

The foregoing is YANMAR's only obligation to you and your exclusive remedy for breach Of Warranty. Failure to follow the requirements for submitting a claim under this warranty may result in a waiver of all claims for damages and other relief. **In no event shall YANMAR or any authorized Industrial engine dealer or distributor be liable for incidental, special or consequential damages.** Such consequential damages may include, but not be limited to, loss of revenue, loan payments, cost of rental of substitute equipment, insurance coverage, storage, lodging, transportation, fuel mileage, and telephone costs. The limitations in this warranty apply regardless of whether your claims are based on breach of contract, tort (including negligence and strict liability) or any other theory. Any action arising hereunder must be brought within one (1) year after the cause of action accrues or it shall be barred. Some states and countries do not allow certain limitations on warranties or for breach of warranties. **This warranty gives you specific legal rights, and you may also have other rights which vary Form state to state and country to country.** Limitations set forth in this paragraph shall not apply to the extent that they are prohibited by law.

Warranty Modifications:

Except as modified in writing and signed by the parties, this warranty is and shall remain the complete and exclusive agreement between the parties with respect to warranties, superseding all prior agreements, written and oral, and all other communications between the parties relating to warranties. **No person or entity is authorized to give any other warranty or to assume any other obligation on behalf of YANMAR, either orally or in writing.**

Questions:

If you have any questions or concerns regarding this warranty, please call or write to the nearest authorized YANMAR industrial engine dealer or distributor or other authorized facility.

EMISSION SYSTEM WARRANTY

YANMAR CO., LTD. LIMITED EMISSION CONTROL SYSTEM WARRANTY – USA ONLY

Your Warranty Rights and Obligations:

■ California

The California Air Resources Board (CARB), the Environmental Protection Agency (EPA) and YANMAR Co., Ltd. hereafter referred to as YANMAR, are pleased to explain the **emission control system warranty** on your industrial compression-ignition engine. In California, model year 2000 or later off-road compression-ignition engines must be designed, built and equipped to meet the state's stringent anti-smog standards. In all states, 1998 and later non-road compression-ignition engines must be designed, built and equipped to meet the United States EPA emissions standards. YANMAR warrants the emission control system on your engine for the periods of time listed below provided there has been no abuse, neglect or improper maintenance of your engine.

Your emission control system may include parts such as the fuel injection system, the air induction system, the electronic control system, EGR(Exhaust Gas Recirculation) system and Diesel Particulate Filter. Also included may be hoses, belts, connectors and other emission-related assemblies.

Where a warrantable condition exists, YANMAR will repair your non-rod compression-ignition engine at no charge to you including diagnosis, parts and labor.

Manufacturer's Warranty Period:

The model year 1998 or later certified and labeled non-road compression-ignition engines are warranted for the periods listed below. If any emission-related part on your engine is found to be defective during the applicable warranty period, the part will be replaced by YANMAR.

If your engine is certified as	And its maximum Power is	And its rated speed is	Then its warranty period is
Variable speed or Constant speed	kW<19	Any speed	1,500 hours or two (2) years whichever comes first. In the absence of a device to measure the hours of use, The engine has a warranty period of two(2) years.
Constant speed	$19 \leq \text{kW} < 37$	3,000rpm or higher	1,500 hours or two (2) years whichever comes first. In the absence of a device to measure the hours of use, The engine has a warranty period of two(2) years/
Constant speed	$19 \leq \text{kW} < 37$	Less than 3,000rpm	3,000hours of five (5) years whichever comes first. In the absence of a device to measure the hours of use, the Engine has a warranty period of five(5) years.
Variable speed	$19 \leq \text{kW} < 37$	Any speed	3,000 hours or five (5) years whichever comes first. In the absence of a device to measure the hours of use, the engine has a warranty period of five (5) years.
Variable speed or Constant speed	$\text{kW} \geq 37$	Any speed	3,000 hours or (5) years whichever comes first. In the absence of a device to measure the hours of use, The engine has a warranty period of five (5) years.

Limited emission control system warranty – USA only – continued

Warranty Coverage:

This warranty is transferable to each subsequent purchaser for the duration of the warranty period. Repair or replacement of any warranted part will be performed at an authorized YANMAR industrial engine dealer or distributor.

Warranted parts not scheduled for replacement as required maintenance in the operation manual shall be warranted for the warranty period. Warranted parts scheduled for replacement as required maintenance in the operation manual are warranted for the period of time prior to the first scheduled replacement. Any part repaired or replaced under warranty shall be warranted for the remaining warranty period.

During the warranty period, YANMAR is liable for damages to other engine components caused by the failure of any warranted part during the warranty period.

Any replacement part which is functionally identical to the original equipment part in all respects may be used in the maintenance or repair of your engine, and shall not reduce YANMAR's warranty obligations. Add-on or modified parts that are not exempted may not be used, The use of any non-exempted add-on or modified parts shall be grounds for disallowing a warranty.

Warranted Parts:

This warranty covers engine components that are a part of the emission control system of the engine as Delivered by YANMAR to the original retail purchaser, Such components may include the following:

- Fuel injection system
- Electronic control system
- Cold start enrichment system
- Intake manifold
- Turbocharger systems
- Exhaust manifold
- EGR system
- Positive crankcase ventilation system
- Hoses, belts, connectors and assemblies associated with emission control systems
- Exhaust gas after treatment (Diesel Particulate Filter (DPF))

Since emissions-related parts may vary slightly between models, certain models may not contain all of These parts and other models may contain the functional equivalents.

Limited emission control system warranty – USA only – continued

Exclusions:

Failures other than those arising from defects in material and/or workmanship are not covered by this warranty. The warranty does not extend to the following: malfunctions caused by abuse, misuse, improper Adjustment, modification, alteration, tampering, disconnection, improper or inadequate maintenance or use Of non-recommended fuels and lubricating oils; accident-caused damage, and replacement of expendable Items made in connection with scheduled maintenance. YANMAR disclaims any responsibility for Incidental or consequential damages such as loss of time, inconvenience, loss of use of equipment/engine Or commercial loss.

Owner's Warranty Responsibilities:

As the engine owner, you are responsible for the performance of the required maintenance listed in Your owner's manual. YANMAR recommends that you retain all documentation, including receipts, covering maintenance on your non-road compression-ignition engine, but YANMAR cannot deny Warranty solely for the lack of receipts, or for your failure to ensure the performance of all scheduled maintenance.

YANMAR may deny your warranty coverage of your non-road compression-ignition engine if a part has Failed due to abuse, neglect, improper maintenance or unapproved modifications.

Your engine is designed to operate on diesel fuel only. Use of any other fuel may result in your engine no Longer operating in compliance with applicable emissions requirements.

You are responsible for initiating the warranty process. You must present your engine to a YANMAR dealer As soon as a problem exists. The warranty repairs should be completed by the dealer as expeditiously as Possible. If you have any questions regarding your warranty rights and responsibilities, or would like Information on the nearest YANMAR dealer or authorized service center, you should contact YANMAR America Corporation.

Website: (www.yanmar.com)

E-mail: CSsupport@yanmar.com

Toll free telephone number: 1-800-872-2867, 1-855-416-7091

FOREWARD

Thank you very much for purchasing our tractor, which, we feel sure, will give you many years of troubling the service.

The introduction in this manual set out the correct manner of operating, maintaining and checking the tractor to ensure long-term durability.

Please ensure correct operation of the tractor as incorrect operation can cause substantial mechanical damage as well as cause accidents with the associated injuries.

Please note that in some cases differences can exist between this manual and your tractor due to the manufacture's policy of constant product improvement.

In the event that you strike a problem not covered by this manual please contact your nearest dealer who will assist you in resolving your problem.







WARNING

CALIFORNIA Proposition 65 Warning

The Engine Exhaust from this product contains chemicals known to the state of California to cause cancer, birth defects or other reproductive harm

WARNING SIGNS IN THIS MANUAL

The following warning signs in this manual draw additional attention to items of importance for the safe and correct operation of the tractor.

SIGN	MEANING OF THE SIGN
 Danger	Serious hazard with a very high level of risk of either serious injury or death
 Warning	Hazard or unsafe practice that can lead to severe injury or death.
 Caution	Hazard or unsafe practice that can lead in injury or death.
 Important	Instructions for the correct operation of the machine which, if followed, will ensure that it performs at it's best

All information, illustrations and specifications in this manual are based on latest information available at the time of publication. The right is reserved to make changes at any time without notice.

CONTENTS

Sr. No.	Description	Page No.
1.	Tractor Identification	9
2.	About this manual	10
3.	Introduction & description	11~12
4.	Owner assistance	13
5.	ROPS (Roll over protection structures)	14~16
6.	Safety instructions, Do's & Don'ts	17~29
7.	Safety signs	30~32
8.	Universal symbols	33
Section A		
9.	Controls, Instruments & Operations	34~59
Section B		
10.	Lubrication & maintenance	60~79
Section C		
11.	Specifications	80~84
12.	Fuel saving Tips	85~86
13.	Fault tracing	87~90
14.	Wiring Diagram	91
16.	Tractor history card	92
17.	Service record	93
18.	Daily operating Log	94
19.	Part replacement record	95

All information, illustrations and specifications in this manual are based on latest information available at the time of publication. The right is reserved to make changes at any time without notice.

TRACTOR IDENTIFICATION

The engine number is stamped on the left hand side of the engine block.

The chassis number is shown on the left hand side of the tractor as shown in the drawing.

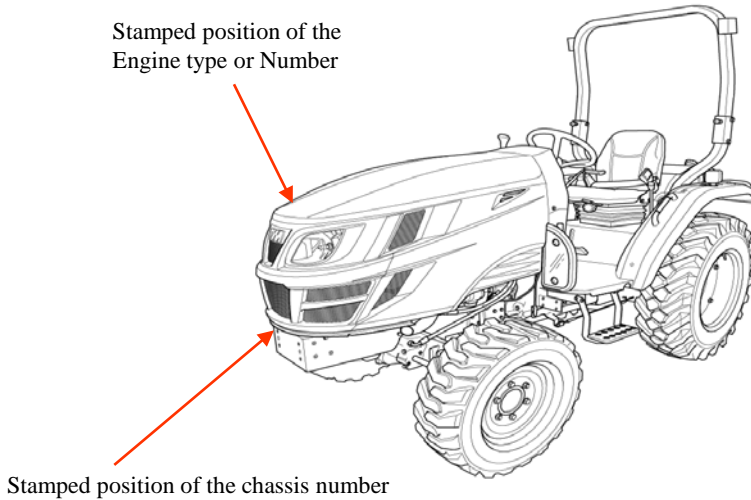

Illustration A

WARRANTY OF THE PRODUCT.

The manufacturer warrants this product and full details of the warranty are provided on a separate warranty schedule.

SERVICE.

Service is available from any TYM dealer in the country.

PARTS.

To obtain spare parts please contact your nearest dealer and give him the details listed below.

Tractor model

Tractor serial number

Tractor engine number

Part number and description

Quantity required.

ABOUT THIS MANUAL

This manual has been prepared to assist you in following/adopting the correct procedure for running-in operation and maintenance of your new TYM Tractor.

Your Tractor has been designed and built to give maximum performance, with good fuel economy and ease of operation under a wide variety of operating conditions.

Prior to delivery, The tractor was carefully inspected, both at the factory and by your TYM Dealer/Distributor, to ensure that it reaches you in optimum conditions .

To maintain this condition and ensure trouble free performance.

It is important that the routine services, as specified in this manual, are carried out at the recommended intervals.

Read this Manual carefully and keep it in a convenient place for future reference.

If at any time you require advice concerning your Tractor, do not hesitate to contact your Authorized TYM dealer/Distributor.

He has trained personnel, genuine parts and necessary equipments to undertake all your service requirements.

TYM policy is one of continuous improvement, and the right to change prices, specifications or equipments at any time without notice is reserved.

All data given in this book is subject to production variations.

Dimensions & weight are approximate only and the illustrations do not necessarily show Tractors in standard condition.

For exact information about any particular Tractor, please consult your TYM dealer/Distributor.

Introduction & Description

► TRACTOR AN INTRODUCTION

The word, 'Tractor' has been derived from 'Traction' which means pulling.

A Tractor is required to pull or haul an equipment, implement or trolley which are coupled to the Tractor body through suitable linkage.

A Tractor can also be used as a prime mover as it has a power outlet source which is also called Power Take or PTO shaft.

In this book the operating, maintenance and storage instructions for all models of TYM Diesel Tractors has been complied.

This material has been prepared in detail to help you in the better understanding of maintenance and efficient operation of the machine.

If you need any information not given in this manual, or require the services of a trained mechanic, please get in touch with the TYM Dealer/Distributor in your locality.

Dealer/Distributors are kept informed of the latest methods of servicing Tractors.

They stock genuine spare parts and are backed by the Company's full support.

Through this manual.

The use of the terms LEFT, RIGHT, FRONT and REAR must be understood, to avoid any confusion when following the introductions.

The LEFT and RIGHT means left and right sides of the Tractor when facing forward in the driver's seat, Reference to the FRONT indicates the radiator end of the Tractor, while the REAR, indicates the drawbar end (illustration B)

When spare parts are required, always specify the Tractor and engine serial number when ordering these parts. (See illustration A).

This will facilitate faster delivery and help ensure that the correct parts for your particular Tractor is received.

The tractor serial number is punched on a plate attached to the left hand side of the engine body (illust. A), For easy reference, we suggest you to write the number in the space provided in the owner's personal data.

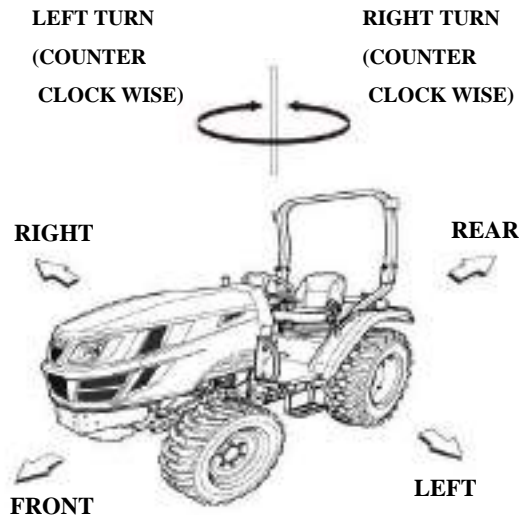

illustration A

(Front, Rear,Left,Right Portion)

► DESCRIPTION

■ General construction

The transmission case, Clutch, Clutch housing, Engine and Front Axle Support are bolted together to form a rigid unit

■ Front Axle & Wheels

The 4WD front axle is a center-pivot, reverse Eliot type.

The front wheel drive mechanism is incorporated as a part of the axle.

The front wheel drive power is taken off the rear transmission and transmitted to the differential in the front axle where the power is divided into right and left and to the respective final cases.

In the final cases, the transmitted revolution is reduced by the level gears to drive the front wheel.

The 4WD mechanism with level gears provides wider steering and greater durability.

■ Engine

The tractors are fitted with vertical, Water-cooled 4-cycle and spherical chamber type YANMAR ENGINES(3TNV88C-KKTF).

■ Clutch and Transmission

A single plate dry clutch (8.86" diameter) is used on these tractors.

Tractor with IPTO(Independent Power Take Off) are fitted with hydraulic Clutch Assy.

The transmission Gear box has Twelve forward speeds & Twelve reverse speeds with high-low selector lever, Presently, TYM Tractors are fitted with partial synchro mesh type gears.

■ Brakes

TYM tractors are provided with independent disc brakes operated by two road travel.

A foot brake lever is fitted for parking.

■ Rear axle & Wheels

This is mounted on ball bearings and is enclosed in removable housing which are bolted to the transmission case.

The rim & Disc fitted with Rear tires are bolted to the outer flange of Rear Axle.

■ Hydraulic system & Linkages.

TYM Tractors are fitted with Live (i.e. system is in operation even when clutch is disengaged.) independent, very touch of hydraulic System.

Three point Linkages can be used for category 1 type of implements.

■ Steering

It consists of Hydrostatic Power steering system, which has a hydraulic cylinder and tandem type hydraulic pump

■ Electrical System

A 12 Volt Battery is used to activate the Engine through the Starter Motor and the Electrical system comprising Horn, Head Lamp, Turn signal lamp, Taco-meter, Hour meter, Brake lamp, Gauge lamp, Hazard Lamp.

General or Alternator, Fuse box also from part of the Electrical system.

OWNER ASSISTANCE

We at TYM CO.,LTD and your TYM Dealer/Distributor wants you to be completely satisfied with your investment. Normally any problems with your equipment will be handled by your Dealer/Distributor's Service Departments, however, misunderstanding can occur.

If you feel that your problem has not been handled to your satisfaction, we suggest the following.

Contact the owner or General Manager of the Dealership, explain the problem, and request assistance.

When additional assistance is needed, Your Dealer/Distributor has direct access to your office.

If you cannot obtain satisfaction by doing this, contact the TYM CO.,LTD. Office and provide them with;

- **Your name, address and telephone number**
- **Model and Tractor serial number**
- **Dealer/Distributor Name & Address**
- **Machine purchase date and Hours used**
- **Nature of problem**

Before contacting TYM CO.,LTD office, be aware that your problem will likely to be resolved in the Dealership using the Dealer's/Distributor's facilities, equipment and personnel.

So it is important that your initial contact be with the Dealer/Distributor.

(ROPS) Roll Over Protective Structures

► **ROLL OVER PROTECTIVE STRUCTURES (ROPS)**

TYM Tractors are equipped with a frame for the protection of operators.

In the case of cab tractors the frame is incorporated in the cab structure.

The objective of the frame or cab structure is to protect the operator in the event of a roll over and they are designed to support the entire weight of the tractor in that event.

Each TYM ROPS frame or cab structure is designed and has been tested to meet industry and or Government standards.

Included in these tests were all mounting bases and bolts or other fasteners.

DANGER

For ROPS frames to be effective and protect the operator, the seat belt provided must be worn in order to keep operators within the ROPS protected area in the event of a roll over. Failure to use the seat belt can still cause serious injury or death.

On some models the ROPS frame has a fold down feature, which can be used to enter low buildings etc.

Take care when lowering the upper section of the ROPS frame and take extreme care while driving the tractor with the ROPS frame lowered.

Do not wear the seat belt with the ROPS lowered and please remember that the fold down facility is for special circumstances only and must not be lowered for general use.

Use of the tractor with the ROPS lowered can cause fatal injuries.

As the ROPS frame or cab together with the seat belt was designed to meet certain standards, they must be maintained in good order and condition.

To achieve this objective, both the structure and the seat belt should be inspected on a regular basis (every time the tractor is serviced)

In the event that the seat belt is damaged or frayed, it should be replaced and in the event that the ROPS frame or any part of the mounting structure is damaged or cracked, the faulty component must be replaced with a new unit.

Such a unit must meet all of the test criteria of the original unit.

Fitment of an inferior item or items affects the certification of the entire ROPS structure and the effectiveness of the structure in the event of an accident.

Drilling or welding of the ROPS structure is forbidden.

► DAMAGE OF THE ROPS

If the tractor has rolled over or the ROPS has damaged (such as striking an overhead object during transport), It must be replaced to provide the original protection.

After an accident, check for damages to the 1.ROPS.2.Seat 3.seat belt & seat mountings.

Before you operate a Tractor, replace all damaged parts.



► DO NOT WELD, DRILL OR STRAIGHTEN THE ROPS



Warning

Never attach chains, ropes to the ROPS for pulling purposes; this will cause the Tractor to tip backwards.

Always pull from the Tractor drawbar.

Be careful when driving through door opening or under low overhead objects.

Make sure there is sufficient overhead clearance for the ROPS fatal injuries



Warning

If the ROPS is removed or replaced, make certain that the proper hardware is used to replace the ROPS and the recommended torque values are applied to the attaching bolts



Warning

Always wear your seat belt if the tractor is equipped with ROPS

How to adjust the Seat

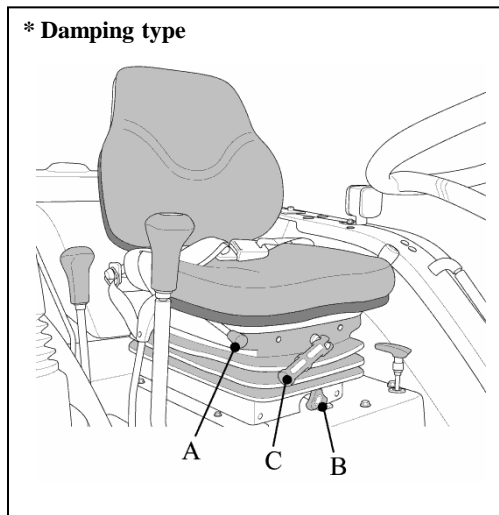

NOTE: Do not use solvents to clean the seat.

Use warm water with a little detergent added.

Before operating a Tractor it is important to adjust the seat to the most comfortable position & check whether it is properly locked in its position.

Figure 1 identifies the seat fitted to your Tractor.

► **FOR SLIDING SEAT**

■ **Sliding Seat type**

Lift lever (A) and slide the seat to the position you want. Release the lever.

Make sure the seat is locked in position.

■ **Damping Seat type**

Lift lever (A) and slide the seat to the position you want. Release the lever.

Make sure the seat is locked in position. Turn knob (B) to adjust the height of the seat.

Turn lever (C) to adjust the damping effect of the seat.

The adjustment required will be dependant on the operator's weight.



Danger

Check whether the seat properly locked in its position before driving the tractor.



Danger

Always use the seat belt when the ROPS is installed.

Do not use the seat belt if a foldable ROPS is down or there is no ROPS.

Check the seat belt regularly and replace if frayed or damaged

SAFETY INSTRUCTIONS

RECOGNIZE SAFETY INFORMATION

This symbol means **ATTENTION! YOUR SAFETY IS INVOLVED.**
The message that follows the symbol contains important information about safety. Carefully read the message

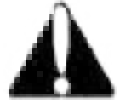

SIGNAL WORDS.

A signal word—**DANGER, WARNING OR CAUTION**—is used with safety alert symbol. **DANGER** identifies the most serious hazards. Safety signs with signal Word —**DANGER OR WARNING**—are typically near specific hazards. General precautions are listed on **CAUTION** safety signs.



DANGER



WARNING



CAUTION

READ SAFETY INSTRUCTION

Carefully read all safety instructions given in this manual for your safety. Tempering with any of the safety devices can cause serious injuries or death. Keep all safety signs in good condition. Replace missing or damaged safety signs.

Keep your tractor in proper condition and do not allow any unauthorized modifications to be carried out on the Tractor, which may impair the function/safety and affect Tractor life.

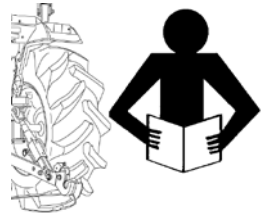

PROTECTION CHILDREN

Keep children and others away from the Tractor while operating.

BEFORE YOU REVERSE

- Look behind Tractor for children.
- Do not let children to ride on Tractor or any implement.



USE OF ROPS AND SEAT BELT

The Roll Over Protective Structure (ROPS) has been certified to industry and/or government standards. Any damage or alteration to the ROPS, mounting hardware, or seat belt voids the certification and will reduce or eliminate protection for the operator in the event of a roll-over. The ROPS, mounting hardware, and seat belt should be checked after the first 100 hours of Tractor and every 500 hours thereafter for any evidence of damage, wear or cracks. In the event of damage or alteration, the ROPS must be replaced prior to further operation of the Tractor.

The seat belt must be worn during machine operation when the machine is equipped with a certified ROPS.

Failure to do so will reduce or eliminate protection for the operator in the event of a roll over.



PRECAUTION TO AVOID TIPPING

Do not drive where the Tractor could slip or tip.

Stay alert for holes and rocks in the terrain, and other hidden hazards.

Slow down before you make a sharp turn.

Driving forward out of a ditch or mired condition could cause Tractor to tip over backward. Back out of these situations if possible



PARK TRACTOR SAFELY

Before working on the Tractor ;

Lower all equipment to the ground.

Stop the engine and remove the key



KEEP RIDERS OFF TRACTOR

Do not allow riders on the Tractor.

Riders on Tractor are subject to injury such as being stuck by foreign objects and being thrown off of the Tractor



HANDLE FUEL SAFELY-AVOID FIRES

Handle fuel with care; it is highly flammable. Do not refuel the Tractor while smoking or near open flame or sparks.

Always stop engine before refueling Tractors.

Always keep your tractor clean of accumulated grease, and debris.
Always clean up spilled fuel.



STAY CLEAR OF ROTATING SHAFTS

Entanglement in rotating shaft can cause serious injury or death.

Keep PTO shield in place at all times.

Wear close fitting clothing. Stop the engine and be sure PTO drive is stopped before making adjustments, connections, or cleaning out PTO driven equipment.



ALWAYS USE SAFETY LIGHTS AND DEVICES

Use of hazard warning lights and turn signals are recommended when towing equipment on public roads unless prohibited by state or local regulations.

Use slow moving vehicle (SMV) sign when driving on public road during both day & night time, unless prohibited by law



PRACTICE SAFE MAINTENANCE

Understand service procedure before doing work.

Keep the surrounding area of the Tractor clean and dry.

Do not attempt to service Tractor when it is in motion.

Keep body and clothing away from rotating shafts.

Always lower equipment to the ground. Stop the engine.

Remove the key. Allow Tractor to cool before any work repair is caused on it.

Securely support any Tractor elements that must be raised for service work.

Keep all parts in good condition and properly installed.

Replace worn or broken parts. Replace damage/missing decals.

Remove any buildup of grease or oil from the Tractor.

Disconnect battery ground cable(-) before making adjustments on electrical systems or welding on Tractor



AVOID HIGH-PRESSURE FLUIDS

Escaping fluid under pressure can penetrate the skin causing serious injury. Keep hands and body away from pinholes and nozzles, which eject fluids under high pressure. If ANY fluid is injected into the skin. Consult your doctor immediately.



PREVENT BATTERY EXPLOSIONS

Keep sparks, lighted matches, and open flame away from the top of battery. Battery gas can explode.

Never check battery charge by placing a metal object across the poles.



PREVENT ACID BURNS

Sulfuric acid in battery electrolyte is poisonous. It is strong enough to burn skin, cause holes in clothing and cause blindness if found entry into eyes.

For adequate safety always;

- 1.Fill batteries in a well-ventilated area.
- 2.Wear eye protection and acid proof hand gloves
3. Avoid breathing direct fumes when electrolyte is added.
4. Do not add water to electrolyte as it may splash off causing severe burns.

If you spill acid on yourself;

- 1.Flush your skin with water.
- 2.Flush your eyes with water for 10-15 minutes.

Get medical attention immediately.



SERVICE TRACTOR SAFELY

Do not wear a necktie, scarf or loose clothing when you work near moving parts. If these items were to get caught, severe injury could result.

Remove rings and other jeweler to prevent electrical shorts and entanglement in moving parts.



WORK IN VENTILATED AREA

Do not start the Tractor in an enclosed building unless the doors & windows are open for proper ventilation, as tractor fumes can cause sickness or death. If it is necessary to run an engine in an enclosed area remove the exhaust fumes by connecting exhaust pipe extension.



TRACTOR RUNAWAY

1. The tractor can start even if the transmission is engaged position causing Tractor to runaway and serious injury to the people standing nearby the tractor.
2. For additional safety keep the pull to stop knob (fuel shut off control) in fully pulled out position. Transmission in neutral position, Foot brake engaged and PTO lever in disengaged position while attending to Safety Starter Switch or any other work on Tractor.

SAFETY STARTER SWITCH

1. Clutch operated safety switch is provided on all Tractors which allow the starting system to become operational only when the Clutch pedal is fully pressed.
2. Do not By-pass this safety starter switch or work on it. Only Authorized Dealers are recommended to work on safety starter switch.
3. On some models Safety Starter switch is provided on transmission High-low shifter lever and in PTO shifter lever. The tractor can be started only if High-low shifter lever is in neutral position.



Caution

Safety Starter Switch is to be replaced after every 2000 hours/4 years, whichever is earlier

SAFE OPERATION OF YOUR TRACTOR

The manufacturer of your tractor has made every effort to make it as safe as is humanly possible.

Beyond this point it is the responsibility of the operator to avoid accidents and we ask that you read and implement our suggestions for your safety.

Ensure that only trained and competent operators use this tractor and ensure that they are fully conversant with the machine and aware of all it's control and safety features.

Operators should not operate the tractor or associated machinery while tired or untrained.

To avoid accidents please ensure that the operator wears clothing which will not get entangled in the moving parts of the tractor or machine and protect him or her from the elements.

When spraying or using chemicals, please ensure that clothing and protective equipment is worn which prevents respiratory or skin problems.

For full details consult the manufacturer of the chemicals.

To avoid lengthy exposure to noise ensure that ear protection is worn.

If adjustment to the tractor or machinery need to be made ensure the tractor or machine are turned off beforehand.

Use of certified Roll Over Protection Structure (ROPS) is a must while operating a tractor.

Use of seat belt is a must while operating a tractor.

In summary, ensure at all times that the safety of the operator and any other worker is paramount.

SAFETY TIPS DURING MAINTENANCE

1. At least on a daily basis check all oil levels.

Water level in the radiator and electrolyte level in the battery and perform services according to the service schedule.

2. Ensure tire pressure are even and the correct pressure for the job being done is maintained.
3. Check to ensure that the all controls and preventative mechanisms of the Tractor and implement work correctly and effectively.
4. Ensure that an adequate set of the correct tools is available for maintenance and minor repairs.
5. Ensure that all service work and repairs are carried out on a flat area with a concrete or similar floor.

Do not carry out service work on a tractor until it is switched off, and the parking brake applied and wheels chocked.

Where a tractor is started in a confined area, ensure that the area is well ventilated as exhaust gases are very harmful, and can cause death.

6. Do not work under raised implements.
7. When changing wheels or tires ensure that a suitable wheel stand is placed under the axle prior to removing the wheel and the wheels are chocked.
8. Where guards or shields need to be removed to perform a service or repair, ensure that the guard or shield is correctly reinstalled before starting the Tractor.
9. Never refuel near an open flame or with an overheated engine.

Ensure to turn off Engine before refueling.

10. The cooling system operates under pressure, take care when removing the Radiator cap on a hot engine to prevent being scalded by steam or hot water.

Do not add water in the radiator when the engine is hot.

Add water to the radiator only after the engine cools down completely.

11. To prevent fires keep the tractor including the engine clean and free from inflammable material and well away from fuels and other inflammable material.

► MOUNTING AND DEMOUNTING IMPLEMENTS

- (1) Ensure that all mounting and removal of implements is done on safe flat ground.
Ensure no one is between the Tractor and implement and do not get under the implement to avoid accidental injuries.
- (2) After mounting the implement, ensure that all sway chains are correctly adjusted and, where PTO shafts are used that the shaft is fitted and secured correctly.
- (3) Where heavy implements are used, ensure that the combination is well balanced or use proper ballast to achieve balance.
- (4) Before leaving the tractor at any time, lower the implement, stop the PTO shaft where applicable, set the parking brake and switch off the engine.
- (5) While operating the implements with the PTO keep all bystanders away from any moving parts and do not attempt to make adjustments while the machine is running.
- (6) Only the driver should ride on the Tractor with the ROPS frame fitted and with the seat belt properly fastened.
- (7) Where young children are present, particular care should be taken and the tractor should not be moved until the whereabouts of all children is known.
- (8) Only trained operators should operate the Tractor and so taking care to ensure that other workers are not injured.
In particular they should take care during dusty operations, which will reduce visibility substantially.
- (9) Never start the tractor unless the transmission is out of gear, the operator is in the seat and all round safety has been checked.
- (10) Only operate the tractor seated in the drivers seat and never turn or brake suddenly at high speed as this can cause a roll-over and serious injury or death.
- (11) When traveling on a public road ensure that the tractor and driver both meet all laws relating to safety and licensing.
When traveling with wide implements use red flags on the extremities and observe all legal including escort requirements.
- (12) When operating under adverse conditions, hilly terrain or on bad ground adjust the speed of the tractor to suit the conditions, safety comes first.
Never drive down hill at high speed or with the transmission in neutral.
Use of the braking capacity of the engine as well as the service brakes.
Do not try to change gear going up or down a steep slope, select the correct gear before starting.
- (13) Take care when traveling uphill with a heavy implement to ensure that it does not overbalance and tip up the front end.
- (14) Never remove or modify the seat belt.
- (15) Never remove, modify or repair the ROPS frame.

PLEASE REMEMBER THAT A LITTLE BIT OF EXTRA CARE CAN PREVENT SERIOUS INJURY OR TEATH AND AVOID DAMAGE TO YOUR TRACTOR.

► THE FOLLOWING PRECAUTIONS ARE SUGGESTED TO HELP PREVENT ACCIDENTS.

A careful operator is the best operator.

Most accidents can be avoided by observing certain precautions .

Read and take the following precautions before operating the Tractor to prevent accidents.

Tractor should be operated only by those who are responsible and properly trained to do so.

■ The Tractor

1. Read the operator's manual carefully before using the tractor.

Lack of operating knowledge can lead to accidents.

2. Use an approved rollover bar and seat belt for safe operation.

Overturning of a tractor without a rollover bar can result in death or injury.

3. **Do not remove ROPS (Roll Over Protective Structure).**

Always use the seat belt.

4. Fiberglass canopy does not give any protection.

5. To prevent falls, keep steps and platform clear of mud and oil.

6. Do not permit anyone but the operator to ride on the Tractor.

There is no safety place for extra riders.

7. Replace all missing, illegible or damaged safety signs.

8. **Keep safety signs clean of dirt and grease**

■ Servicing the Tractor

1. Keep the tractor in good operating condition for your safety.

An improperly maintained Tractor can be hazardous.

2. Stop the engine before performing any service on the tractor.

3. The cooling system operates under pressure, which is controlled by the radiator cap.

It is dangerous to remove the cap while the system is hot.

First turn the cap slowly to stop and allow the pressure to escape before removing the cap entirely.

4. **Do not smoke while the refueling the tractor.**

Keep away any type of open flame.

5. The fuel in the injection system is under high pressure and can penetrate the skin.

Unqualified persons should not remove or attempt to adjust a pump, injector, nozzle or any part of the fuel injection system.

Failure to follow these instructions can result in serious injury.

6. **Keep open flame away from battery or cold weather starting aids to prevent fire or explosions.**

7. **Do not modify or alter or permit anyone else to modify or alter this tractor or any of its components or any tractor functions**

■ Operating the tractor

1. Before starting the tractor apply the parking brake, place the PTO (Power Take Off) lever in the “OFF” position, the hydraulic control levers in the downward position, the remote control valve levers in the neutral position(if fitted) and the transmission in neutral.
2. Do not start the engine or controls while standing besides the tractor.
Always sit on the tractor seat when the engine or operating controls.
3. Safety starter switch.

In order to prevent the accidental starting of the tractor, a safety switch has been provided.

The starting system of the tractor is connected through this switch, which becomes operative only when the clutch pedal is depressed.

On some models shuttle shifter lever and PTO button should also be in neutral position for completing the starting circuit.

Do not bypass the safety starter switch.

Consult your TYM Tractor Dealer/Distributor if safety- starting switch malfunctions.

4. Avoid accidental contact with the gear shifter lever while the engine is running.
Unexpected Tractor movement can result from such contact.
5. Do not get off or climb the tractor while it is in motion.
6. Shut off the engine, remove the key and apply the parking brake before getting off the tractor.
7. Do not operate the tractor in an enclosed building without adequate ventilation.
Exhaust fumes can cause death.
8. Do not park the tractor on a steep slope.
9. **If power steering or Engine seizes to operate, stop the tractor immediately.**
10. Pull only from the swinging draw bar or the lower link drawbar in the down position.
Use only a drawbar pin that locks in place.
Pulling from the tractor rear axle carriers or any point above the rear axle may cause the Tractor’s front end to lift.
11. If the front end of the tractor tends to rise when heavy implements are attached to the three-point linkage, install front end or front wheel weights.
Do not operate the tractor with a light front end.
12. Always use hydraulic position control lever when attaching equipments/implement and when transporting equipment.
Be sure that the hydraulic couplers are properly mounted and will disconnect safely in case of accidental detachment of implement.
13. Do not leave equipment/implement in the raised position.
14. Use the flasher/ Turn signal lights and Slow Moving Vehicle (SMV) signs when driving on public roads during both day and night time, unless prohibited by law.
15. Dim tractor lights when meeting a vehicle at night.
Be sure the lights are adjusted to prevent the blinding on the eyes of coming vehicle operator.
16. Emergency stopping instruction; If tractor fails to stop even after application of brakes, Pull the knob of fuel shut off control rod.

■ Driving the tractor

1. Watch where you are going especially at row ends, on roads, around trees and low hanging obstacles.
2. To avoid upsets, drive the tractor with care and at speeds compatible with safety, especially when operating over rough ground, crossing ditches or slopes, and when turning at corners.
3. Lock the tractor brake pedals together when transporting on roads to provide proper wheel braking.
4. Keep the tractor in the same gear when going downhill as used when going uphill. Do not coast or free wheel down hills.
5. Any towed vehicle and/or trailer whose total weight exceeds that of the towing Tractor, must be equipped with its own brakes for safe operation.
6. When the tractor is stuck or tires are frozen to the ground, back out to prevent upset.
7. Always check overhead clearance, especially when transporting the tractor.

■ Operating the PTO (Power Take Off)

1. When operating PTO driven equipment, shut off the engine and wait until the PTO stops before getting off the tractor and disconnecting the equipment.
2. Do not wear loose clothing when operating the power take-off or near rotating equipment.
3. When operating stationery PTO driven equipment, always apply the tractor parking brake and block the rear wheels from front and rear side.
4. To avoid injury, always move down flip part of PTO. Do not clean, adjust or service PTO driven equipment when the tractor engine is running.
5. Make sure the PTO master shield is installed at all times and always replace the PTO shield cap When the PTO is not in use.

■ Diesel fuel

1. Keep the equipment clean and properly maintained.
2. Under no circumstances should gasoline, alcohol or blended fuels be added to diesel fire or explosive hazard. Such blends are more explosive than pure gasoline. In a closed container, such as a fuel tank. DO NOT USE THESE BLENDS.
3. Never remove the fuel cap or refuel the tractor with the engine running.
4. Do not smoke while refueling or when standing near fuel.
5. Maintain control of the fuel filler pipe when filling the tank.
6. Do not fill the fuel tank to capacity. Allow room for expansion.
7. Wipe up spilled fuel immediately.
8. Always tighten the fuel cap securely.
9. If the original fuel tank cap is lost, replace it with genuine cap. A none approved cap may not be safe.
10. Do not drive equipment near open fire.
11. Never use fuel for cleaning purpose.
12. Arrange fuel purchases so that winter grade fuel are not held over and used in the spring.

N.B: It is suggested that after repairs if any of the Safety Decal/sign is peeled/defaced, the same may be replaced immediately in interest of your safety.

DO'S AND DON'T'S

► **DO'S-For Better performance**

DO-Ensure that safety shields are in place and in good condition.

DO-Read all operating instructions before commencing to operate Tractor.

DO-Carry out all maintenance tasks without fail.

DO-Keep the air cleaner clean.

DO -Ensure that the correct grade of lubricating oils is used and that they are replenished and changed at the recommended intervals.

DO-Fit new sealing rings when the filter elements are changed.

DO-Watch the oil pressure gauge or warning light and investigate any abnormality immediately.

DO-Keep the radiator filled with clean water and in cold weather use anti-freeze mixture. Drain the system only in an emergency and fill before starting the engine.

DO-Ensure that the transmission is in neutral before starting the engine.

DO-Keep all fuel in clean storage and use a filter when filling the tank.

DO-Attend to minor adjustments and repairs as soon as necessity is apparent.

DO-Allow the engine to cool before removing the radiator filler cap and adding water, remove the radiator cap slowly.

DO-Shift into low gear when driving down steep hills.

DO-Latch the brake pedals together when driving on a highway.

DO-Keep draft control lever fully down when not in use.

Don'ts-For safe operation

DON'T-Run the engine with the air cleaner disconnected.

DON'T-Start the tractor in an enclosed building unless the doors and windows are open for proper ventilation.

DON'T-Operate the tractor or engine while lubricating or cleaning.

DON'T-Allow the tractor to run out of diesel fuel otherwise it will be necessary to vent the system.

DON'T-Temper the fuel injection pump, If seal is broken the warranty becomes void.

DON'T-Allow the engine to run idle for a long period.

DON'T-Run the engine if it is not firing on all cylinders.

DON'T-Ride the brake or clutch pedal. This will result in excessive wear of the brake lining, clutch driven member and clutch release bearing.



DON'T-Use the independent brakes for making turns on the highway or at high speeds.

DON'T-Refuel the tractor with the engine running.

DON'T-Mount or dismount from the right side of the tractor.

DON'T-Temper the hydraulic control levers' upper limit stops.

DON'T-Use draft control lever for lifting of implements.

DON'T-Start the engine with the PTO engaged.

DON'T-Use the governor Control Lever (Hand throttle) while driving on roads.

DON'T-Move the hydraulic levers rearward.

SAFETY SIGNS

► GENERAL SAFETY INFORMATION

IMPORTANT: This “General safety Information” should be kept with the machine at all times as reference data.



This symbol means **ATTENTION! YOUR SAFETY IS INVOLVED.**

The message that follows the symbol contains important information about safety. Follow recommended precautions and safe operating practice.

DECALS ON THE DASH COVER

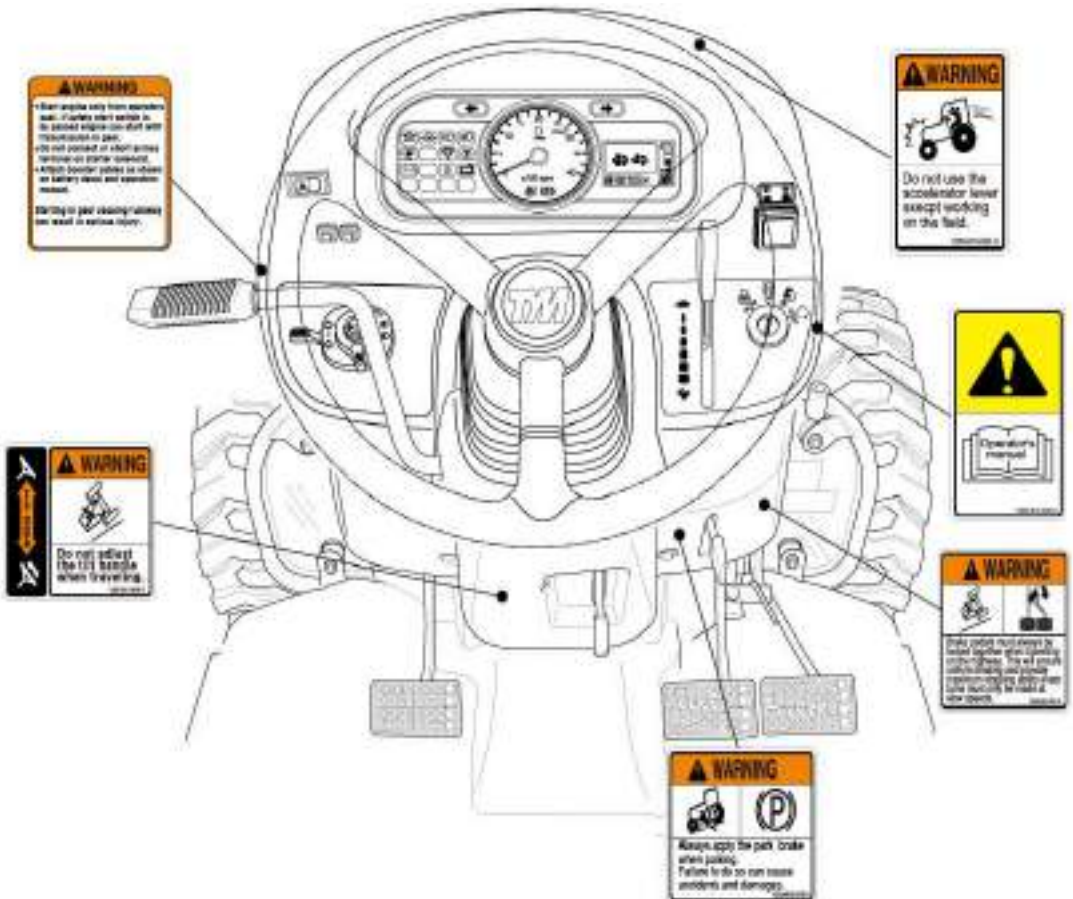

DECALS ON THE CHASSIS

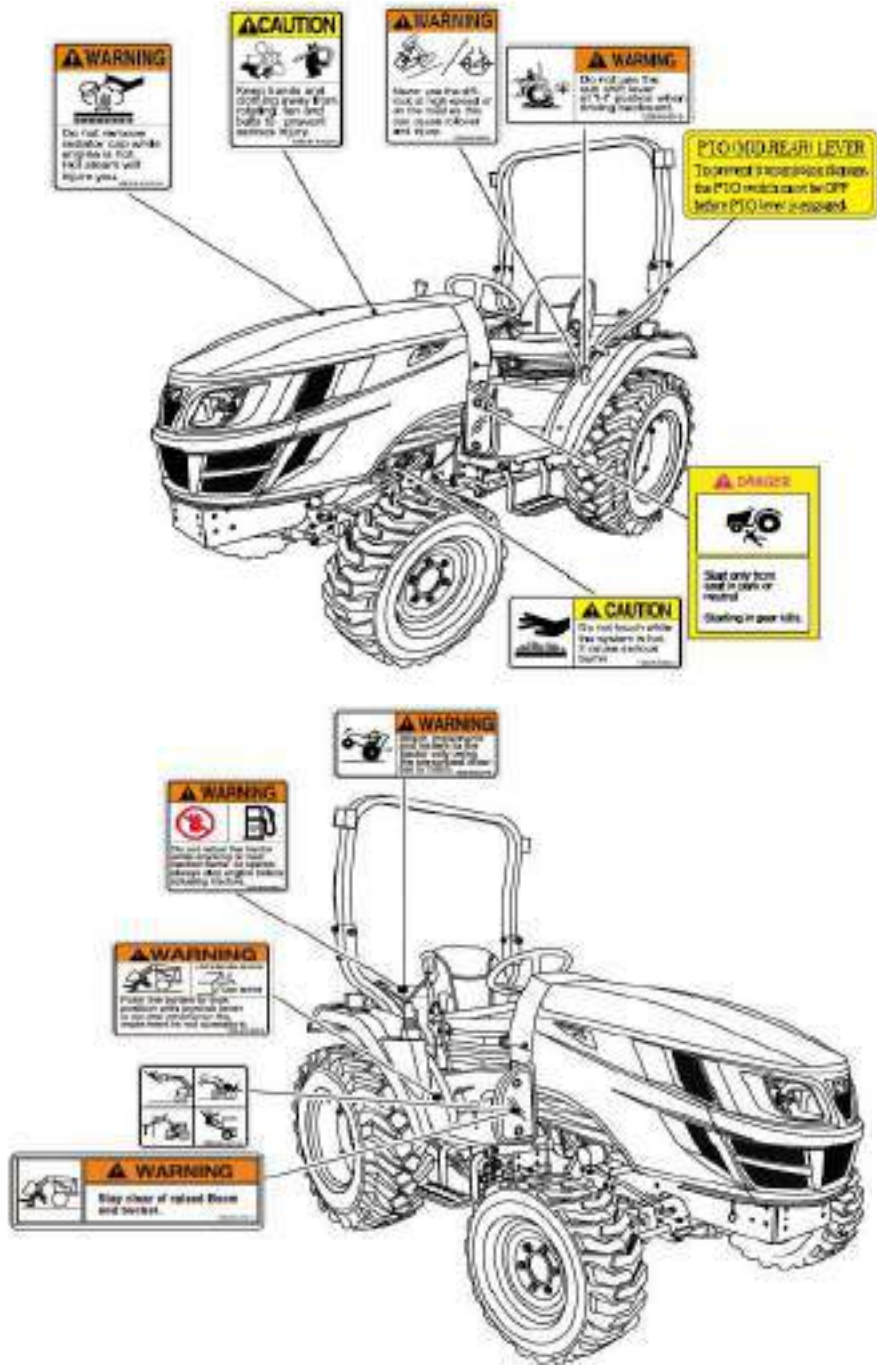



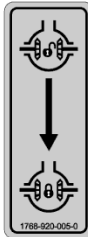
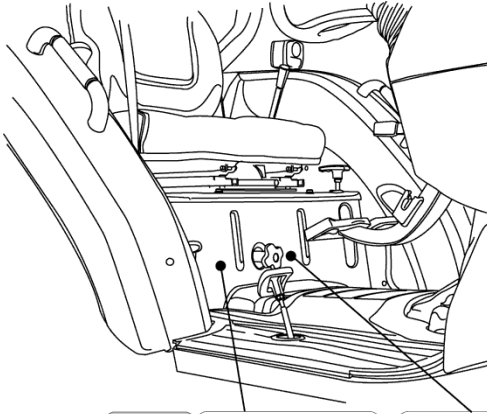





























DECALS AROUND THE SEAT



UNIVERSAL SYMBOLS

Some of the universal symbols have been shown below with an indication of their meaning

	Engine speed rev/minX100)		Pressured- open slowly		Corrosive substance
	Hours, recorded		Continuous variable		"Tortoise" Slow or minimum Setting
	Engine coolant temperature		Warning		"Hare" fast or maximum setting
	Fuel level		Hazard warning		Transmission oil pressure
	Engine Stop control		Neutral		Turn signal
	Lights		Fan		Transmission oil temperature
	Horn		Power take off engaged		Parking brake
	Engine oil pressure		Power take off disengaged		Work lamps
	Air filter		Lift arm/raise		Differential lock
	Battery charge		Lift arm/lower		See operator's manual
	Regen Request Lamp		Exhaust Temp Lamp		

Controls, Instruments And Operations

The following pages in this section detail the location and function of various instruments, switches and controls on your Tractor.

Even if you operate other Tractors, you should read through this section of the manual and ensure that you are thoroughly familiar with the location and function of all the features of your New Tractor.

Do not start the engine or attempt to drive or operate the Tractor until you are fully accustomed to all the controls.

It is too late to learn once the Tractor is moving.

If in doubt about any aspect of the operation of the tractor consult your **TYM** Tractor Dealer/Distributor.

Particular attention should be paid to the recommendations for running-in to ensure that your tractor will give long life and dependable service for which it was intended

DESCRIPTION OF TRACTOR CONTROLS

► INSTRUMENT AND SWITCHES

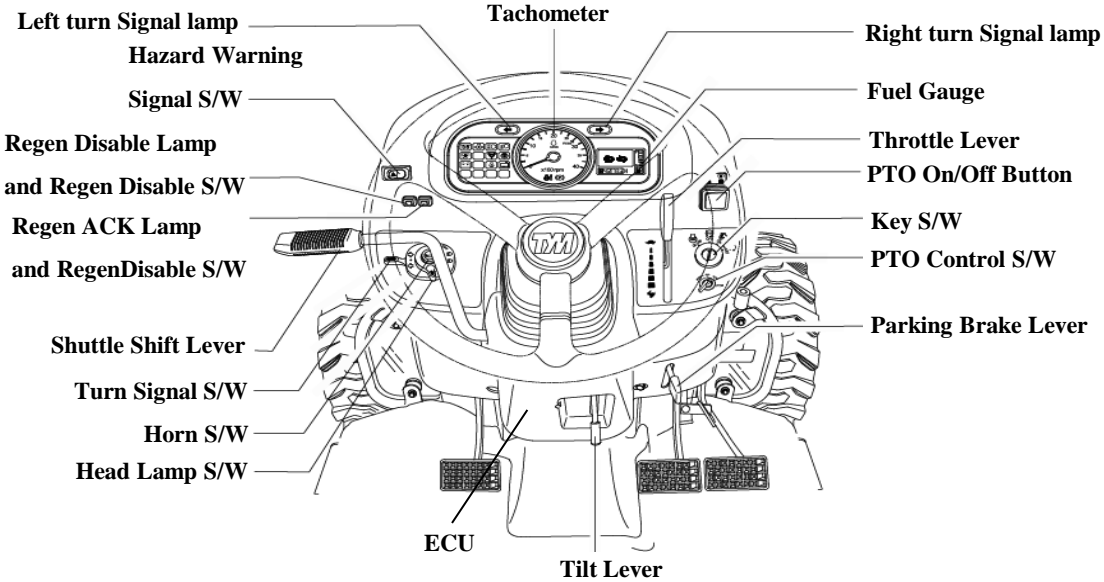

► MAIN SWITCH (KEY SWITCH)

[OFF] - The key can be inserted or removed

[ON] - The electric circuit is on.

[GLOW] - Glow plugs preheat the combustion chamber

[START] - The starter motor is engaged.

When the key is released it will return to the ON position

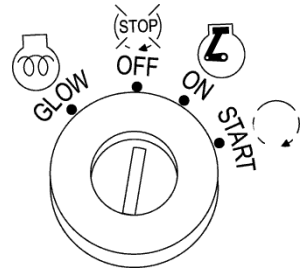

► HEAD LAMP, TURN SIGNAL SWITCH AND HORN

■ HEAD LAMP SWITCH

High and low beam are operated On the main switch

Position ①. Low beam

Position ②. High beam

■ TURN SIGNAL SWITCH

Pull the turn signal lever down to signal a left turn.

Push the turn signal lever up to signal a right turn.

■ HORN

Push the Red button.

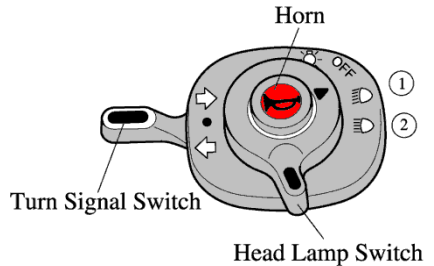

► HOUR METER

The hour meter consists of five digits where the last digit indicates 1/10th of an hour



► TACHOMETER

This meter shows the revolutions of the engine and the PTO shafts as well as the travel speed in top gear.



► FUEL GAUGE

Shows the amount of fuel in the tank when the ignition switch is ON.



► WATER TEMPERATURE

This comes on when the coolant temperature is over 110 degrees.



► HAZARD WARNING SIGNAL SWITCH

Push the hazard warning signal once to operate the hazard warning light. (Left and right turn indicators flash).

Push the hazard warning light switch again to switch off the hazard warning lights.

Hazard Warning Signal S/W



►WARNING LIGHTS

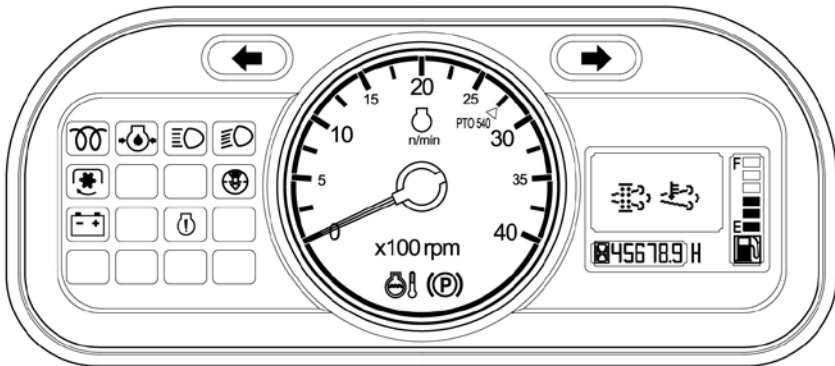

Charge lamp



This light will go off as soon as the engine starts to run to indicate that the alternator is changing. (Please note, as broken fan belt can cause the light to come on, please stop the engine as overheating can occur if not rectified immediately)

Oil pressure lamp



Will go out as soon as the engine starts if the oil pressure is correct.

If it comes on while the engine is running, stop the engine and get expert advice.



PTO monitor Lamp

Shows the revolution of PTO Refer to monitor lamp on Page 32



Fuel Level : If it comes on while the engine is running, Fill the tank with fuel.



High beam lamp is operated on the combination switch.



Low beam lamp is operated on the combination switch



Parking brake lamp is operated when footbrake is engaged.



Glow signal Lamp indicates preheating



4WD drive lamp is operated on when front-wheel drive is also engaged.



Check lamp is operated when the key switch is set to ON position and a safety start condition is not satisfied.



Cruise Control Lamp is operated on when cruise control is engaged.

Air cleaner filter contamination indicator



This comes on when the air cleaner is clogged by foreign materials.

When this comes on, open the cover and clean the inside of the cleaner.

Also, blow air through the filter in the direction of intake air to clean it or replace the filter with a new one.



Regen Request Lamp

See 41Page.



Exhaust Temp Lamp

This lamp is illuminated when the DPF temperature is over 400 degrees.



Danger

Allow the engine to cool down before opening radiator cap as serious burns may result due to hot steam & boiling water.

► PTO MONITOR LAMP

■ **THE PTO MONITOR LAMP** on the dash panel indicates the state of the PTO shaft.

1. If the monitor glows: The PTO is rotating
2. If the monitor is off: The PTO is off
3. If the monitor blinks: The PTO is presently stationary but will instantly start rotating of the clutch pedal is released or the implements lowered.



PTO monitor Lamp

Two switches operate the independent PTO.

1. PTO ON/OFF SWITCH: PTO ON/OFF switch is located on the LHS.

On the steering column and can be identified easily with its built in red colored indicator.

When the switch is pushed down to start the PTO indicator glows to

indicate that the switch and the PTO are in ON position,

If the switch is pushed down again the indicator goes off signaling that the PTO is OFF.

2. PTO CONTROL SWITCH: This switch is located near the starting key location on the dash panel.

There are three positions marked for this switch.

■ **OFF** at the center

■ **MANUAL** at the left

■ **AUTO AT THE RIGHT.**

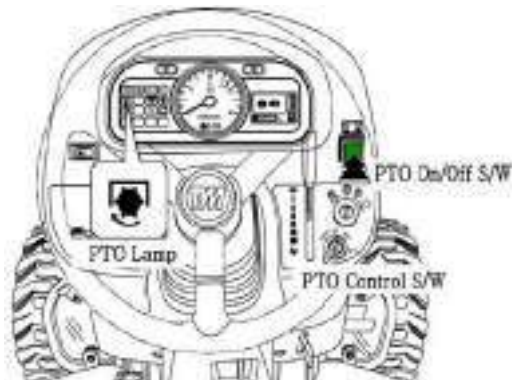

The PTO shaft will not rotate if either of the two switches is in OFF position.

The following table explains how the PTO operates at the two different (Manual & Auto) positions of the PTO control switch with the PTO ON/OFF switch in the on position.

PTO ON/OFFS SWITCH	PTO CONTROL SWITCH	CLUTCH PEDAL	HYDRAULIC POSITION CONTROL LEVER.	PTO MONITOR LAMP ON THE DASH PANEL	PTO SHAFT
On	Manual Mode	Either pressed or released	Either raised or lowered	Glows	Rotates
On	Auto Mode	Pressed	Either raised or lowered	Blinks	Stationary
On	Auto Mode	Either pressed or released	Raised	Blinks	Stationary
On	Auto Mode	Released	Lowered	Glows	Rotates

■ From the table above we learn about the safety features of the PTO.

When the monitor on the dash panel is blinking it indicates to the operator that the PTO is in the on position but temporarily not rotating either because the clutch pedal is pressed or the implement is lifted off the ground or both.

The PTO will start rotating instantaneously when either the clutch pedal is released and/or the implement is lowered to the ground.

■ The operator must use this blinking signal to clear the area around the tractor off bystanders/onlookers as the rotating blades of certain implements can accidentally cause injuries to the persons standing near the tractor.

■ The stopping of the PTO when the implement is lifted off the ground with the position control prevents the damage to the implement or the PTO shaft.



Warning

1. When the PTO control switch is in manual position the PTO does not stop rotating even if the clutch pedal is pressed. If working on hard soils, pavements with a rotary implement the PTO ON/OFF switch must be put to the OFF position to stop the PTO from rotating. If this is not done the rotating blades of the implement will push on the hard ground below and in turn push the tractor toward causing accident which can lead to serious injuries or death.

2. Extra precaution must be taken to clear the area of bystanders/onlookers when using PTO driven implements. The rotating blades of the implements can cause serious injuries on contact. The warning that is indicated by the blinking PTO monitor is to make the operator aware that the PTO is in on position and will instantly start rotating if the clutch pedal is released or implement is lowered or both.

3. In no case the specified rotating speeds indicated by the implement manufacturer be crossed as the same can lead to serious damage to the tractor/equipment and can lead to serious injuries to persons around.

■ Regeneration operation and cautions

► Lamp functions



RegenReqLamp ExhaustTempLamp Engine Warning Lamp

**RegenAck Lamp
& RegenReqSW** **RegenDisable Lamp
& RegenDisableSW**

► Automatic regeneration

The regeneration process is automatically being performed when the exhaust temperature lamp comes on during work.

► Disable switch

Press this switch to stop automatic regeneration.



Caution

Run the system in a well-ventilated area to secure your safety. If running the system in a poorly-ventilated area, such as greenhouses, it can lead to gas poisoning.

► It is necessary to activate the regeneration function manually if the engine warning lamp and regeneration request lamp are illuminated during work.

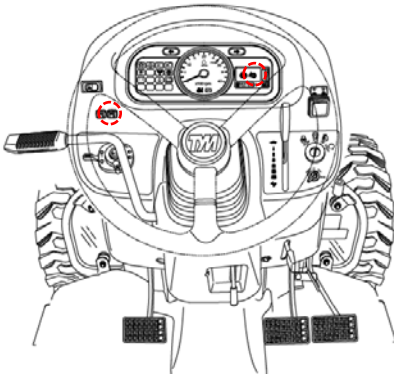

+



+



Engine Warning Lamp

RegenReqLamp

ACK Lamp

1. Stop working and park the vehicle on level ground or in a safe place.



Caution

Never move the vehicle to another place during regeneration process. Sudden movement can result in an accident.

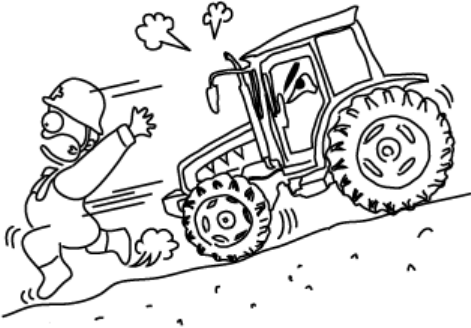

2. Before starting regeneration, apply the parking brake and idle the engine.

Then, the ACK lamp blinks. However, the regeneration process is not performed if the regeneration activation conditions are not satisfied.

3. Press and hold the ACK button for 3 seconds and release it.

Then, the ACK lamp and exhaust temperature lamp are illuminated and the engine speed is increased up to 2200 RPM to perform the regeneration process for approx. 30 minutes.



ExhaustTempLamp ACK Lamp

4. As soon as the regeneration process is completed, all the lamps are turned off.

► TRACTOR CONTROLS

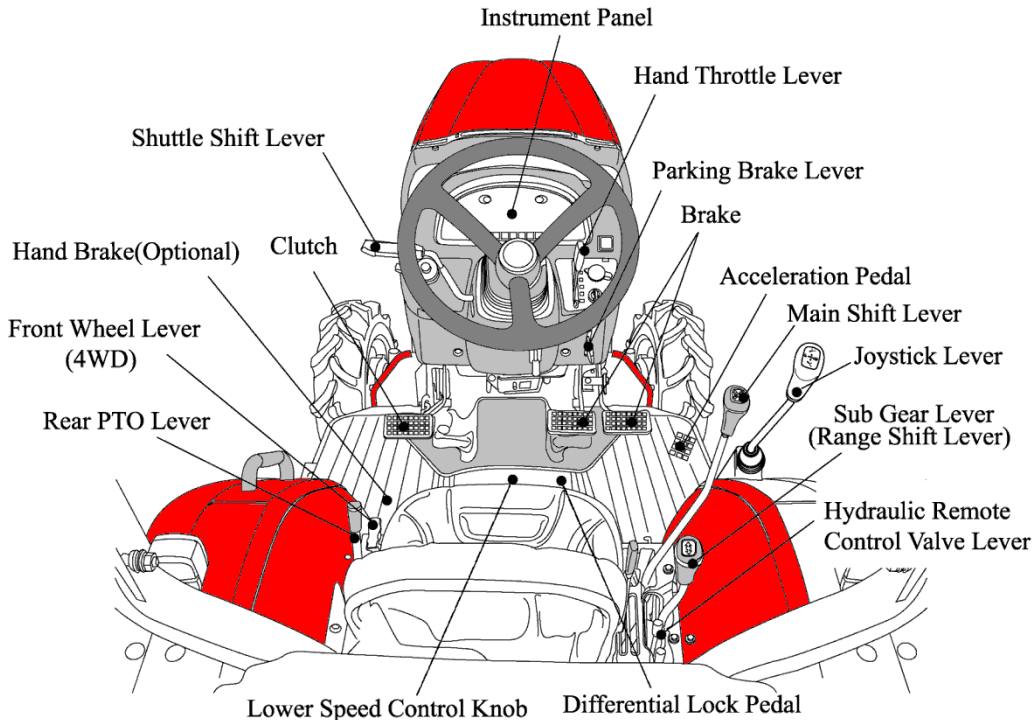

► **THROTTLE LEVER (HAND THROTTLE)**

The hand operated throttle lever is located on the RHS of the Dash cover.

To increase the engine speed, Pull the lever downward.

To decrease the engine speed, Push the lever upward.

The Lever can be left in any position between idle and maximum as required.

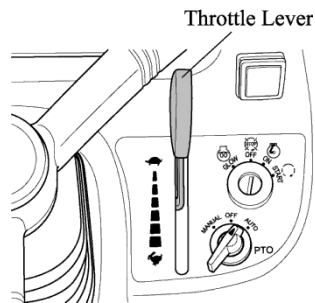

► **SPEED CONTROL PEDAL**

The Speed Control Pedal is located in RHS of the Operator floor.

Depress the forward speed control pedal to move forward.

Depress the reverse speed control pedal to move backward.

The speed control pedal will return in neutral position and the tractor will stop when the speed control pedal is released.

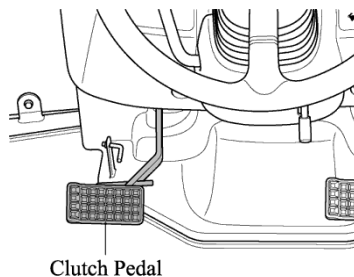

► CLUTCH CUT-OFF ARM

For long term storage of the Tractor it is possible to latch the clutch in the disengaged position. Push the clutch down and engage the latch to hold it there.

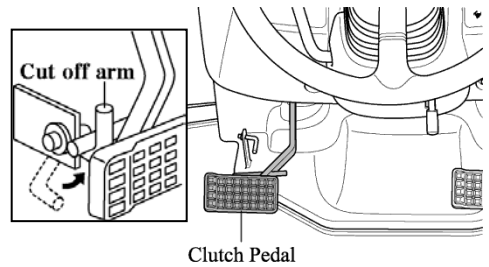

warning

Do not attempt to start engine when this arm is being used.

► BRAKE PEDAL

Right and left brake pedals are provided to assist in turning the tractor in the field.



Caution

A connecting latch is provided to connect the right and left brake pedals for high speed or road use.

In the interest of safety always use it on the road or at high speed as using one side only can cause rollovers.

When servicing the tractor ensure that the adjustment on both sides is the same.

► ACCELERATION PEDAL

This pedal can override a fixed hand throttle setting

► PARKING BRAKE LEVER

Connect the brake pedals, push them down while pulling the park brake up to engage.

Press the parking brake pedal and push the Brake pedal to release.

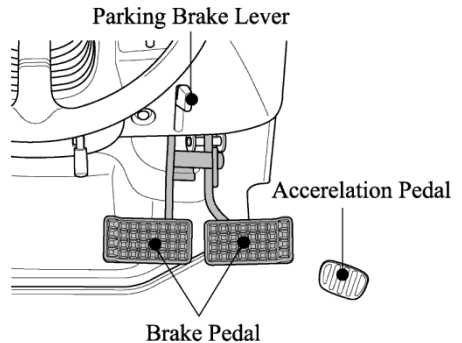

important

Traveling with the parking brake on will damage the brakes.

► SHUTTLE SHIFT LEVER

This control allows shifting from forward to reverse & reverse to forward. When stationary set the lever to **N** for neutral.

- ① Push the lever away from the driver engages forward.
- ② Pulling the lever towards the driver engages reverse.

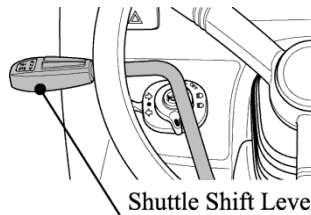

important

1. Press clutch pedal fully before operating shuttle shift lever.
2. When changing from forward to reverse or back to forward again while in high range make sure the tractor comes to a stop before changing direction. Failure to do so is likely to result in damage to the mechanism and place the driver at risk of injury.



Caution

- Operate the shuttle shift only while seated on the tractor.
- Do not use the shuttle shift lever to start the tractor for towing or traveling uphill, use the clutch instead.
- Always stop the tractor before getting off.

► MAIN GEAR LEVER

The Main Gear Lever is located on the RHS of the operator.

This lever can be shifted by using the clutch, both when the tractor is stationary or mobile.

► SUB GEAR LEVER (RANGE SHIFT LEVER)

The Main Gear Lever is located on the RHS of the operator.

Operate the sub gear lever using clutch to select the appropriate speed for different applications.

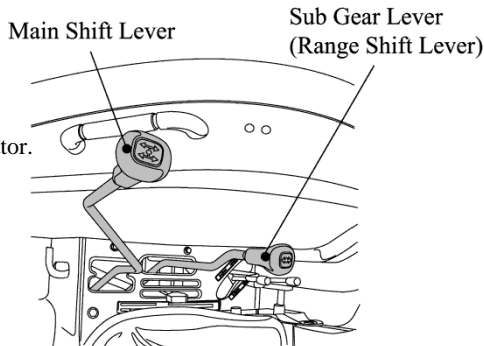

Main gear lever

Sub gear lever (Range Shift lever)



important

Avoid damage!

Select the proper speed range and gear for the job.

- The machine maybe operated in any gear with engine speeds at 950-2800 rpm. Within these limits, the engine can be placed under varying load operations.
- Never overload engine by lugging machine at low idle speeds.
- Raise engine speed the match expected loads. If a slight increase engine rpm occurs simultaneously with moving hand throttle lever forward, the engine is not overloaded.

► FRONT WHEEL DRIVE LEVER (4WD)

The Differential Lock Pedal is located below the LHS of the Operator.

In the ON position the front wheels are engaged and in the OFF position they are disengaged.

Engage & disengage the front wheel drive with the front wheels in the straight position and at low Engine RPM.

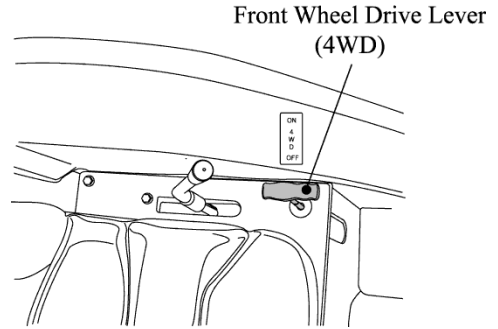

important

Do not use front wheel drive at high speed or on the road as premature wear of components will result.



important

Always use the clutch when using the front wheel drive lever.

Use of front wheel drive improves traction performance.

► DRIVER'S SEAT

To adjust the seat backwards and forwards lift the lever at the front of the seat and set it to the desired position (Please refer to page 11 of how to adjust the seat)

■ Seat Belt

-Release the Seat Belt

Press button **C** and Pull the Male Fitting **A** from the Buckle **B**.

-Adjusting the Seat Belt

Make Sure the belt is across your hip and not over your stomach.

To adjust the male fitting **A** :

1. Pull toggle **D** down the strap by the required distance.
 - a. To make the strap longer, pull end **E** as far as it will go.
 - b. To make the strap shorter, pull end **F** as far as it will go.



► TILT LEVER

To adjust the inclination of the steering wheel with a 3 stages and set it to the desired position.

 Danger	Ensure that the tilt lever has locked before moving the tractor.
--	--

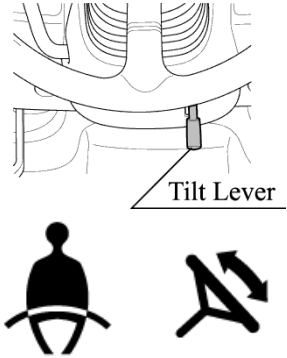

► PTO SELECTION LEVER

Your tractor is equipped with 2 Speed PTO to suit range of applications and conditions.

MODEL \ POSITION	POSITION	1 st	2 nd
T354	REAR PTO	540 rpm	1000 rpm

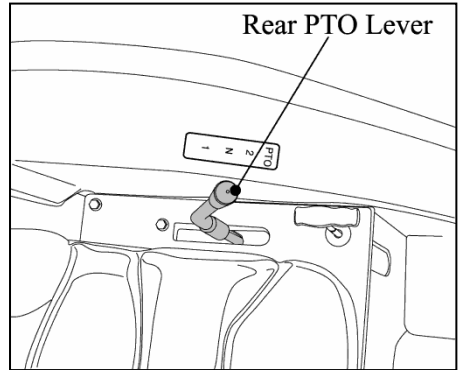

* **Rear PTO** Lever is located on the LHS of Operator.

 important	Always use the clutch when engaging or disengaging the PTO or changing PTO speed. Let the PTO driven implement come to a complete stop before changing.
--	--

 Caution	Do not operate any implement at a high speed than is specified for it. When making adjustments to the implement stop the engine to avoid serious injury. When leaving the tractor stop the engine, and remove the key. Set the parking brake.
---	--

► OPERATING THE HYDRAULICS

The hydraulics are powered with an engine driven hydraulic pump and controlled with a position control lever mounted beside the driver.

► **HYDRAULIC POSITION CONTROL LEVER**

Hydraulic Position Control Lever is located on the RHS of operator.

Implements can be raised and lowered with the hydraulic position control lever and can be stopped at any position by stopping the lever.

To ensure a consistent working depth the adjustable stop (A) can be set to ensure that the implement returns to the same depth every time.

To raise the implement : Pull the lever backward.

To lower the implement : Push the lever forward.

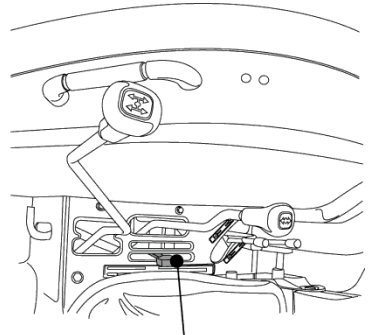

Hydraulic Position Control Lever



Warning

After finishing the work, always lower the implement to the ground and switch off the engine, Set the parking brake to avoid injuries and accidents .

► **LOWERING SPEED CONTROL KNOB FOR THE 3 POINT HITCH**

This knob controls the downward speed of the hydraulics three point linkage and is located below the Seat.

To slow the downward speed- Turn the knob clockwise.

To increase the downward speed, turn the knob anticlockwise.

To lock the knob clockwise.

Do not over tighten the knob.

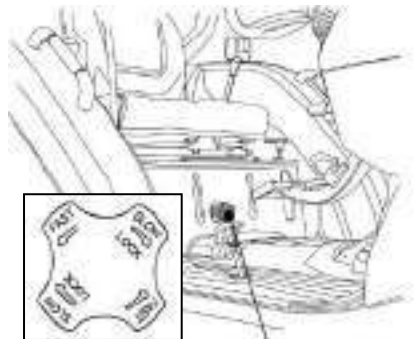

Lower Speed Control Knob



Caution

Always set the knob to lock when

- 1.Traveling on the road
- 2.Replacing tires or blades on an implement.
- 3.Making adjustments to an implement. Sudden dropping of an implement due to hydraulic problems can cause serious injury or death.

► HYDRAULIC REMOTE CONTROL VALVE LEVER

The Hydraulic Remote Control Valve Lever is located on the RHS of Operator.

Move the lever up or down and hold.This will raise or lower the implement (Rotavator or Hydraulic plow).

Important:

- Do not hold the lever in the “pull” or “Push” position once the remote cylinder has reached the end of the stroke as this will cause oil to flow through the relief valve. Forcing oil through the relief valve for extended periods will overheat the oil.
- When Using the tractor hydraulic system to power front loader, do not operate the boom and bucket cylinders simultaneously.

Hydraulic Remote Control Valve Lever

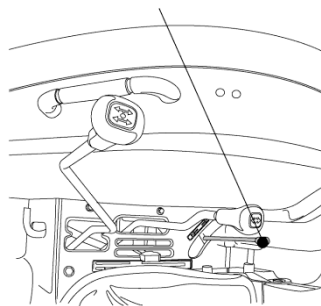

► HYDRAULIC REMOTE CONTROL VALVE COUPLER CONNECTING & DISCONNECTING.

■ Connecting

- 1.Clean both couplers.
- 2.Remove dust plugs.
- 3.Insert the implement coupler to the tractor hydraulic coupler
- 4.Pull the implement coupler slightly to make sure couplers are firmly connected.

■ Disconnecting

- 1.Lower the implement first to the ground to release hydraulic pressure in the hoses.
- 2.Clean the couplers
- 3.Relieve pressure by moving hydraulic control levers with engine shut off.Pull the hose straight from the hydraulic coupler to release it
- 4.Clean oil and dust from the coupler,then replace the dust plugs.

Hydraulic Remote Control Valve Coupler

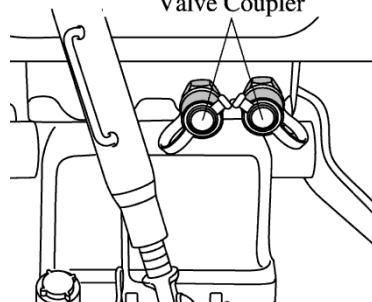

► JOY STICK LEVER (IF EQUIPPED)

The Joy Stick Lever is located on the RHS of the Operator.

This simple joystick lever can control the use of a front-end loader.

And lift-retract, dump-rollback smoothly and act as one handle lever.

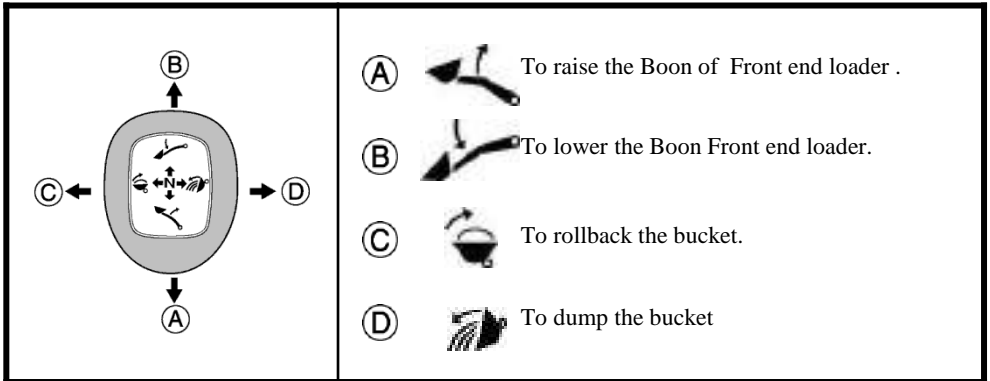
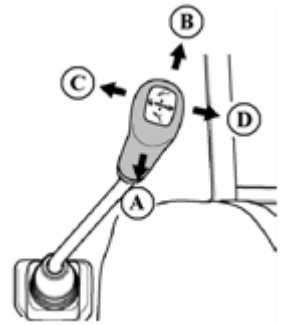

NOTE : The Joystick control and valve can also be used for other applications if a front end loader is not fitted.

► SAFETY LOCKING SYSTEM FOR JOYSTICK LEVER

This simple **Safety** locking system can lock the joystick by pushing the Button and unlocked by pulling .

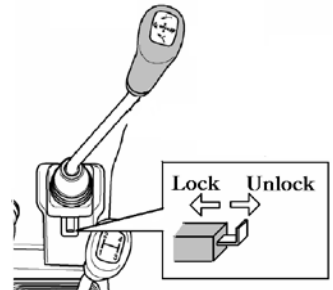

Warning

Hydraulic fluid escaping under pressure can have enough force to penetrate the skin. Hydraulic fluid may also infect a minor cut or opening in the skin. If injured by escaping fluid. See a doctor at once. Serious infection or reaction can result if medical treatment is not given immediately. Make sure all connections are tight and that hoses and lines are in good condition before applying pressure to the system. Release all pressure before disconnecting the lines or performing other work on the hydraulic system. To find a leak under pressure use a small piece of cardboard or wood. Never use hands.

► **OPERATING THE 3 POINT LINKAGE (TPL)**

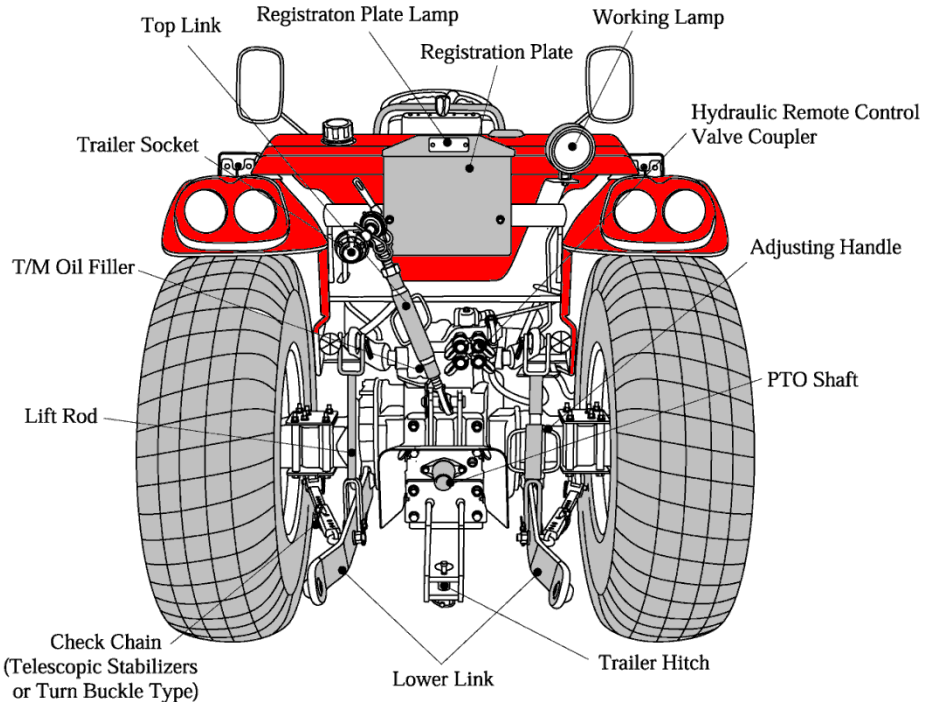
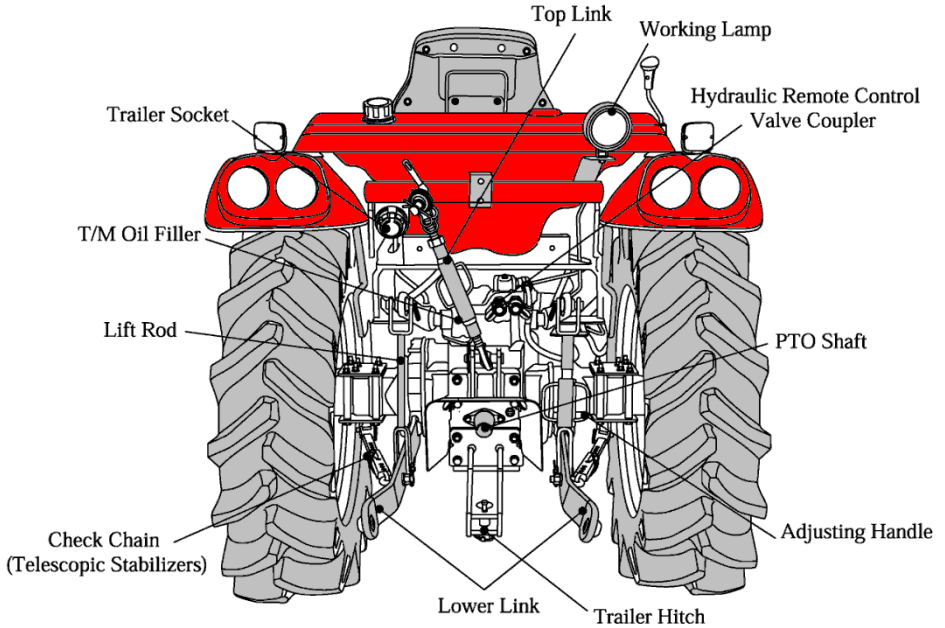

► ADJUSTMENT OF THE CHECK CHAIN

There should be no clearance (Position A) during implement transport and when working with grades, rollers mowers, seeders, drills and similar implements.

However, a slight play is necessary (Position B) when working with ploughs, harrows, ditchers, cultivators.

■ Adjustment of the Telescopic stabilizers type

To adjust the check chain move the Telescopic stabilizer to lengthen or shorten the chain and Fix the Pin as required distance

The stabilizers are intended for limiting or preventing implement side movement.

■ Adjustment of the Turnbuckle type (If equipped)

To adjust the check chain turn the turnbuckle to lengthen or shorten the chain and tighten the lock nut when the correct adjustment is achieved.

* Telescopic stabilizers type

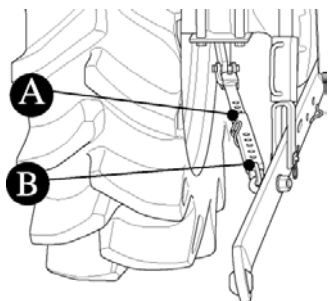

* Turnbuckle type

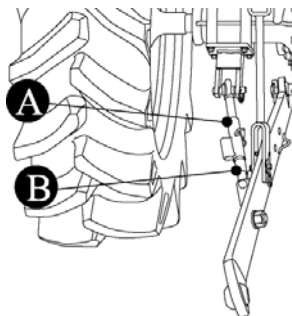

► ADJUSTMENT OF THE TOP LINK

Lengthening or shortening the top link will change the angle of the implement.

The locating hole of the top link varies with the type of implement used.

The most common locations are the 2nd and 3rd hole from the top.

► ADJUSTMENT OF THE LIFT ROD

Adjust the length of the lift rod by screwing the Adjusting Handle (Turnbuckle) in or out.

Adjust the length of the lift rod as necessary to set the implement in its working position parallel to the ground.

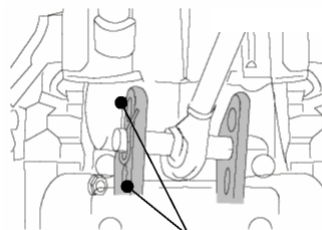

Position of Top link

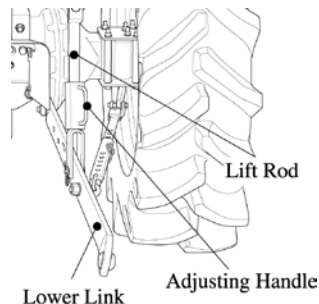

Lower Link

Adjusting Handle

► ADJUSTMENT OF THE YOKE ROD ON THE LOWER LINK

For different applications change the position of the Yoke rod on the lower link holes as shown and insert the pin in the direction of the arrow.

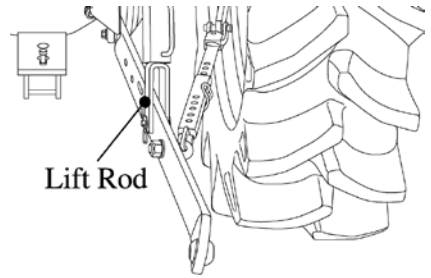

Danger

Only use drawbar to tow and keep the 3 point linkage in raised position when toeing with the drawbar.

Position can create unbalance causing the Tractor to roll-over & Result the death or serious injury.

► MOUNTING IMPLEMENT

If the PTO is used, remove the safety cover off the PTO shaft. Adjust the yoke rod on the lower links to suit the implement in use. Attach the left lower link, then attach the right lower link using the adjusting handle on the leveling box if required. Attach the top link. Attach the PTO shaft to the tractor if used, making sure that it is locked in place.

Adjust the check chains to suit the implement and tighten the locknuts. To remove an implement reverses the procedure

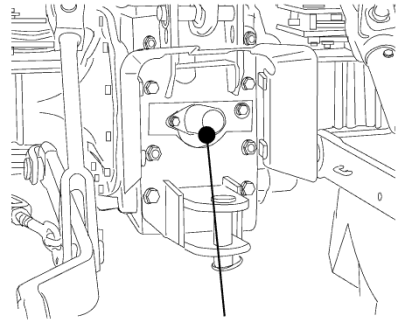

Rear PTO Shaft Cover



Caution

Do not attach a PTO shaft with the engine running and ensure all safety shields are in place.

DRIVING THE TRACTOR

► STARTING THE ENGINE

Before starting the engine carry out the pre-operational checks as set out on page 26.

- (1) Sit on the driver seat
- (2) Apply the footbrake.
- (3) Put the hydraulic lever in the down position.
- (4) Push down the clutch to activate the safety-starting switch.
- (5) Put the main gear lever in neutral
- (6) Insert the ignition key and turn it on
- (7) Ensure that the warning lights are working
- (8) Always turn the ignition key to left for a moment & release it.

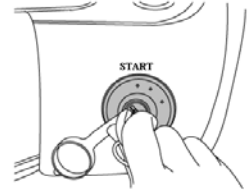

The automatic heater will start working as will be indicated by a light on the instrument panel.

As the lamp goes off turn the key to the start position to start the engine.

- (9) Ensure that all the warning lights are off with the engine running.



Important

Never turn the key to the start position while the engine is running as this can cause serious damage to the starter and engine flywheel.

Only engage the starter for a period of not more than 10 seconds.

If Engine does not start, rest the starter for about 20 seconds and try again for a maximum of 10 seconds. If the engine does not start after repeated attempts, refer to the fault tracing guide.



Important

Especially in cold weather, always allow the tractor to idle for a while to warm up & build up sufficient oil pressure to ensure normal operating temperature for longer engine life.

► STOPPING THE ENGINE

-After light work let the engine idle for a while and turn the key off.



Important

After long or heavy work allow the engine to idle for 5- 10 minutes and turn the key off.

► **WARMING UP**

When starting the engine allow it to warm up to operating temperature by allowing it to idle 5-10 minutes to ensure full lubrication and operating temperature.

Failure to do so can shorten engine life substantially.

► **WARMING UP IN COLD WEATHER**

Cold weather will change the viscosity of the oil, resulting in a reduced oil pumping capacity, which can cause damage to the engine if it is not warmed up correctly.

It also causes problems with the hydraulic system and the synchromesh in the transmission.

Correct times for warming up are:

Temperature	Time for warming up
Above 50°F	5~10 min.
50°F~ 32°F	10~20 min.
32°F~14°F	20~30 min.
14°F~-4°F	30~40 min.
Below -4°F	Over 40 min.



Important

Ensure the handbrake (Foot brake) is on during the warming period.

Failure to warm up correctly can result in problems.

When the engine is warm push down the clutch and engage the main and auxiliary gear levers to the required position.

Push down on the brake pedals and release the handbrake.

Increase the engine revolutions and let out the clutch smoothly.

Only change gears with main gear lever while moving and ensure that this is done with fully use of the clutch.

► **STORING ENGINE IN OPERABLE CONDITION FOR 3 MONTHS OR MORE**

When the engine is not operated during storage of three months or more, internal engine parts can rust and lose oil film.

As a result, the engine can seize when it is started after storage.

To prevent such a rust, the engine must be operated periodically during storage.



Caution

Do not "ride" the clutch to control speed, use a lower gear.
Do not travel with your foot on the clutch pedal.



Danger

Always connect the brake pedals when traveling on the road.
Never tow anything except with the drawbar.
Do not tow loads which are too large for the tractor's capacity to brake effectively especially in hilly terrain.
Take special care when towing large or wide implements.
Do not carry passengers.
At all times observe local legislation and road rules.

► **TIGHT TURNS IN THE FIELD**

Disconnect the latch connecting left and right brake pedals to allow the use of individual pedals.

To make a tight turn use both the steering wheel and the brake pedal at the same time.

For a left turns use the left pedal and a right turn the right pedal.



Caution

Perform tight turns only at a slow safe speed.
Doing so at a high speed can cause rollovers and very serious injury or death.

► **NORMAL BRAKING AND PARKING**

Let the engine come back to idle and at the same time push in the clutch and brake simultaneously.

When the tractor has come to a halt, lower any implement to the ground, and put the main gear in neutral.

Apply the park brake, stop the engine, and remove the key.



Illustration



Caution

Always apply the park brake when parking.
Failure to do so can cause accidents and damage.
As an extra precaution when parking on a slope, chock the rear wheels.

► **UPHILL STARTS ON A STEEP SLOPE**

With the pedals connected together push down on the brake pedals and push down the clutch.

Set all gear levers to low and the throttle to medium engine speed.

Release the clutch and as it engages release the brake pedals.

Adjust the throttle to the required speed.

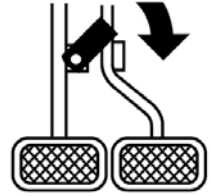

► **DRIVING DOWNHILL**

Use the engine's ability to brake when traveling downhill.

Never rely on the brakes only and never travel downhill with the gears in neutral.



Warning

When operating in hilly terrain the risk of the rollover is increased substantially, please drive with extra care.

When towing trailers in hilly terrain ensure that they are equipped with brakes, use a lower gear to get maximum engine braking and do not change gears on a down hill run

► **OPERATION OF THE DIFF LOCK**

While the diff lock is a very useful feature, care should be taken in its use as misuse can lead to dangerous situations.

The diff lock would only be used in situations where traction is lost on one of the rear wheels.



Warning

Use low engine revolutions when using the diff lock.

If the diff lock does not release after removing the foot from the pedal use the left and right brake pedals in turn to release it.

Do not try to engage or use the diff lock on tight turns as serious damage can result.

► **CHECK DURING DRIVING**

Constantly monitor the warning lights on the dash and if any comes on stop the tractor to determine the cause.

If the oil pressure light comes on check the oil level first of all.

If the oil level is OK ask a qualified dealer to check the reason for the light coming on.

If the alternator warning light comes on check all connections and ensure that the fan belt is not broken.

If all connections and the fan belt are intact consult your dealer to determine the cause of the problem.

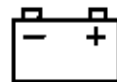

► **FUEL GAUGE.**

To avoid excessive condensation in the fuel tank refill at the end of each day's work and ensure during the day that it does not drop to a low level where the fuel system will require bleeding to expel air in the system after refilling the tank.



► **ENGINE COOLING WATER.**

If the gauge indicates that the engine is running hot, stop the tractor and check the coolant in the radiator.

► **TRAILER SOCKET (Seven Terminal Electrical Socket type)**

Trailer Socket is located on the Left of the Rear Side.

To operate the Electrical systems of implements, trailer lighting, warning lamp etc.



Danger

Allow the engine to cool down before opening radiator cap as serious burns may result due to hot steam & boiling water.

Also check to ensure that the fins in the radiator core are not clogged or that the tractor has a broken or stretched fan belt.



Caution

When traveling on public or farm roads connect both brake pedals and allow for the weight of any mounted implement to ensure that the unit is not unbalanced.
Also allow for the width when passing other road users.
Where fitted use the hazard lights provided.
Strictly follow the local traffic regulations.



Caution

When operating near others with an implement attached take particular care to allow for the width of the implement and avoid accidents.

► TRACK ADJUSTMENT

As some models of TYM are front wheel assist the front track can be set in 2 position.

The rear track can be set in 5 positions as illustrated.

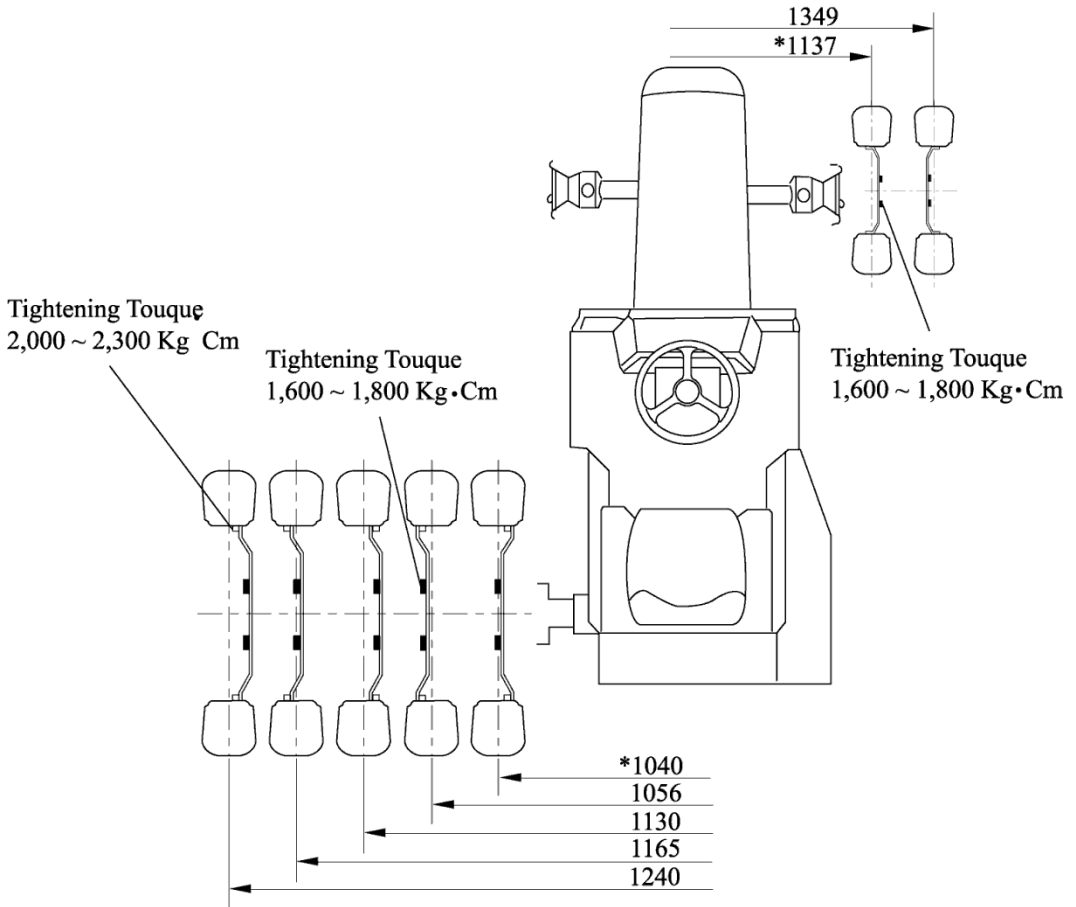

Lubrication & Maintenance

This section gives full details of the service procedures necessary to maintain your Tractor at peak efficiency while the lubrication and maintenance chart provides a ready reference to these requirements.

CHECKS AND SERVICE

► PRE-START CHECKS

To avoid problems it is recommended that a range of checks be carried out daily before starting the tractor.

For full details of the items and frequency please refer to the tables on page 64,65and 66.

► ENGINE COOLANT

Remove the radiator cap and ensure that the coolant is up to the filler neck and that it is clean with the correct anti-freeze or anti corrosion inhibitor in it.

If the coolant is a rusty color, drain the system completely and refill with the correct mixture of water and anti-freeze or corrosion inhibitor.

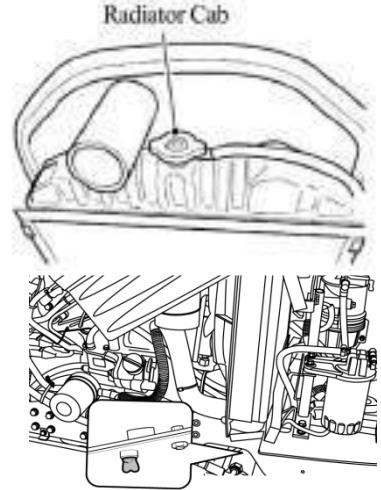

Drain Cock

► ENGINE OIL

Pull out the stick, wipe it and dip in the oil sump.

Ensure that oil level is between the upper and lower mark near the upper mark.

If too low add oil, but never excess 100hrs of service interval.

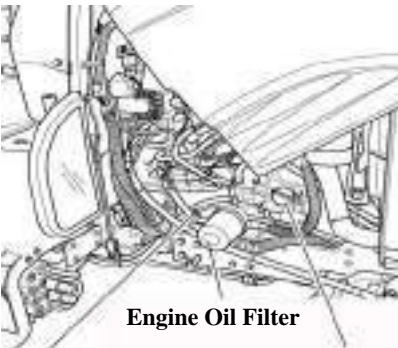

Engine Oil Filter

Engine Oil Filter

Engine Oil Filler

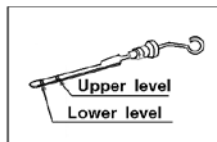

Engine oil gauge

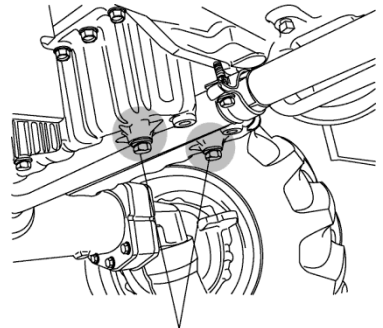

Engine oil drain Plug



important

Do not overfill the crankcase with oil.

► TRANSMISSION OIL

Check the level with the dipstick on top of the transmission in rear of the seat.

If the level is low add oil through the filler hole.

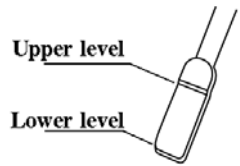

Caution

Always ensure that you use the correct oil for topping up or oil changes

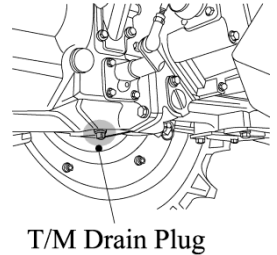
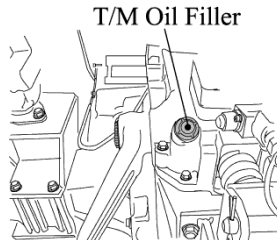
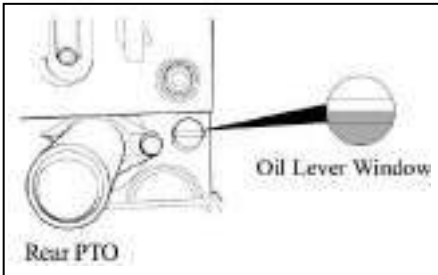

► FUEL

The Fuel Filler is located on the Rear of the Seat.

Use the fuel gauge to check the fuel level and top up if too low.

It is a good practice to refill the tank immediately after use to avoid condensation

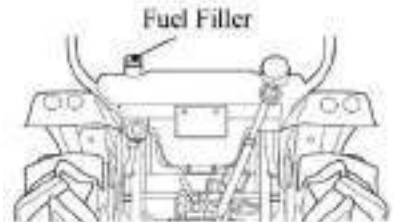

► TYRE PRESSURE

The air pressure used in the tires has a direct bearing on the life of the tire and its performance in the field.

Ensure that the tire pressures are correct and in accordance with the table on page 66.

To make a visual judgment see the drawing on the right.



Excess Standard Lack



important

It is strongly recommended that tire pressures are checked with a proper gauge only & visual inspections are relied upon.



Danger

Excess tire pressure can cause accidents!

► STEERING

Ensure that the steering wheel does not have excessive free play.

► BRAKE

Ensure that the left and right brakes are adjusted correctly so they operate simultaneously.

The correct free play on the brake is 1.18-1.57 in (30~40 mm).

► CLUTCH

Ensure that the clutch is adjusted correctly.

Correct free play on the clutch pedal is 0.78-1.18 in (20~30mm).



Incorrect clutch adjustment can cause excessive wear and reduced tractor performance.

► ELECTRICAL

Check the operation of all gauge, switches, horn, lights and indicators.

► INSTALLING LOADER

1. Connect P port of loader control valve to the line on the tractor marked P (from the PTO valve)
2. Connect the T port on the loader control valve to the line on the tractor marked T
3. Connect the remaining line from the control valve to the line on the tractor marked P1
(to the transmission housing)

► DETACHING THE LOADER (LOADER VALVE OR LOADER CONNECTING PORT)

1. Detach the hydraulic hoses of loader
2. Assemble the cap (PF3/8) with pipe comp (PF3/8).

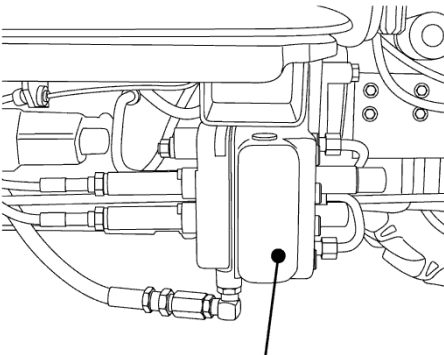

Loader Valve

MAINTENANCE AND ADJUSTMENT SCHEDULE

► Periodical check and service table

○ Check, Top-up or adjust ● Replace

△ Clean or wash

★ Consult the service Dealer

Division	Item	Daily	Service interval(hour meter,mark)												Comment			
			5 0 0	1 0 0	1 5 0	2 0 0	2 5 0	3 0 0	3 5 0	4 0 0	4 5 0	5 0 0	5 5 0	6 0 0				
Engine	Engine oil and cartridge	○	●					●									Every 250Hours After first 50hours	
	Air cleaner			△		△		●		△		●					Refer to 76 page.	
	Radiator coolant	○															Check daily top up If required.	
	Radiator	○															Check daily for damages leakage	
	Fuel	○															Fill tank	
	Fuel filter			○	△	○	△	●	○	○	△	○	△	●				
	Fan belt	○															Check daily	
	Battery			○		○		○		○		○		○			Check daily	
	Oil filter		●					●						●			Every 250Hours After first 50hours	
	Loose nuts and bolts	○															Check daily, Tighten	
	Radiator hose clamp	○															Tighten if required	



Caution

These intervals are for operation under normal conditions and need to be reviewed under severe conditions to a greater frequency

Division	Item	Daily	Service interval(hour meter,mark)												Comment	
			5 0 0	1 0 0	1 5 0	2 0 0	2 5 0	3 0 0	3 5 0	4 0 0	4 5 0	5 0 0	5 5 0	6 0 0		
Chassis	Trans mission oil	<input type="radio"/>	●							●						Change every 300hours After First 50hours
	Free play of clutch pedal	<input type="radio"/>														(0.78-1.18in)
	Free play of brake pedal	<input type="radio"/>														(1.18-1.57)
	State of both brake pedals	<input type="radio"/>														Adjust so that both operate simultaneously and brake at the same time
	Operation of each lever	<input type="radio"/>														Smooth operation
	Free play of steering wheel	<input type="radio"/>														
	Toe-in							★							★	Check every 300hours
	Grease each nipple		<input type="radio"/>	<input type="radio"/>	<input type="radio"/>	<input type="radio"/>	<input type="radio"/>	<input type="radio"/>	<input type="radio"/>	<input type="radio"/>	<input type="radio"/>	<input type="radio"/>	<input type="radio"/>	<input type="radio"/>	<input type="radio"/>	Replenish every 50hours (everyday in dusty conditions)
	Check the steering wheel joint	<input type="radio"/>														Adjust every 300hours
	Wheel nut fastening torque	<input type="radio"/>														Check daily
Operation of the instrument	<input type="radio"/>															

Division	Item	Daily	Service interval(hour meter,mark)												Comment	
			5 0	1 0 0	1 5 0	2 0 0	2 5 0	3 0 0	3 5 0	4 0 0	4 5 0	5 0 0	5 5 0	6 0 0		
Chassis	Adjustment of the throttle pedal	<input type="radio"/>														
	Loose bolts and nuts	<input type="radio"/>														Tighten to proper torque
	Hydraulic oil filter		●						●							
	Oil of the 4WD front axle		●		○		○		○		○		○	○	Replace if leaking	
	Check the electric wiring	<input type="radio"/>													Without loose or broken terminals. Without damaged or missing wiring. Correctly clamped	

Tyre	DIVISION	SIZE	Air pressure Mpa (PSI)	MODEL
R1 (Ag)	Front	7-16, 4PR	0.176 Mpa (25.53 PSI)	T354
	Rear	11.2-24, 8PR	0.235 Mpa (34.08 PSI)	
R1 (Ag)	Front	8-16, 4PR	0.157 Mpa (22.80 PSI)	
	Rear	12.4-24, 6PR	0.157 Mpa (22.80 PSI)	
R4 (Ind)	Front	27X10, 50-15, 8PR	0.414 Mpa (60.04 PSI)	
	Rear	12.5-20 R4, 12PR	0.310 Mpa (45.00 PSI)	
R3 (Turf)	Front	27X10, 50LL-15, 6PR	0.220 Mpa (31.91 PSI)	
	Rear	41X14, 00-20- RL	0.170 Mpa (24.66 PSI)	

► **FILLING DIAGRAM & CAPACITY TABLE**

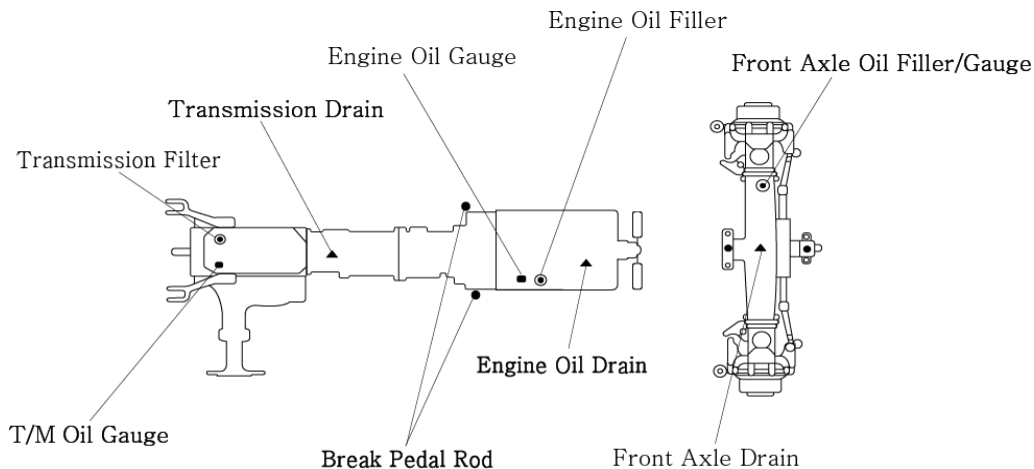

○ Oil Filler Hole ● Greasing Point

▲ Drains ■ Windows

N o.	Filling point	Fillings	Quantity Liter (gal.)
	MODEL		T354
1	RADIATOR	50/50 : Ethylene Glycol/Water (L.L.C) ASTM D4985 / D6210	4.8ℓ(1.27US gal)
2	ENGINE	API : CF-4 grades CJ-4 Above:25°C(77°F)... SAE30 or 15W/40 0°C to 25°C(32°F to 77°F)... SAE20 or 10W30 Below 0°C(32°F)... SAE 10W or 10W-30	3.2ℓ (0.85 US gal)
3	TRANSMISSION CASE	See next page *	35ℓ(9.25 US gal)
4	FRONT AXLE	Gear oil #80 or #90 (API GL-4 grade)	8.2ℓ(2.16US gal)
5	FINAL DRIVE CASE(B)	Gear oil #80 or #90 (API GL-4 grade)	
6	Clutch pedal shaft	Grease	As required
7	BALL JOINT	Grease	As required
8	FUEL TANK	Diesel fuel	33ℓ(8.717 US gal)

► **RECOMMENDED TRANSMISSION OIL**

- ① RPM Tractor Hydraulic Fluid or Textron TDH Premium (CALTEX)
- ② TDH Oil or TDH Oil special (TEXACO)
- ③ Chevron 1000THF (CHEVRON)

► **OPENING METHOD OF EACH COVER**

► **OPENING METHOD OF FAN COVER**

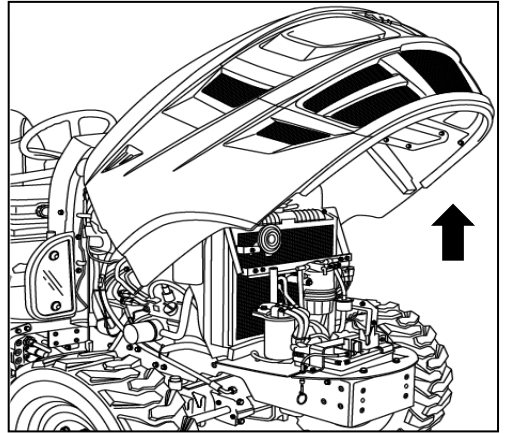
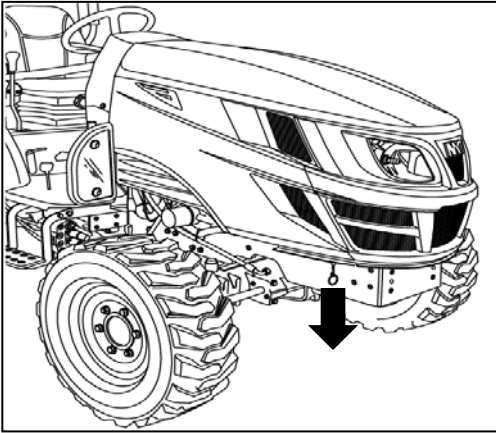

With the hood up, the Hook release lever can be removed by pulling downward, having first detached the hood lamp wiring harness. Hood can be open by itself.

► **FUEL**

- Use clean diesel fuel only .
- Use ultra low sulfur fuel only

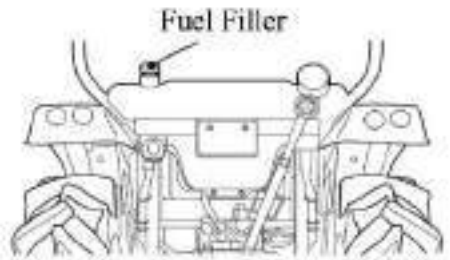

important

As diesel fuel equipment is susceptible to contamination by dust or water, Ensure that all dust and water is kept well away from the fuel tank.

BLEEDING THE FUEL SYSTEM

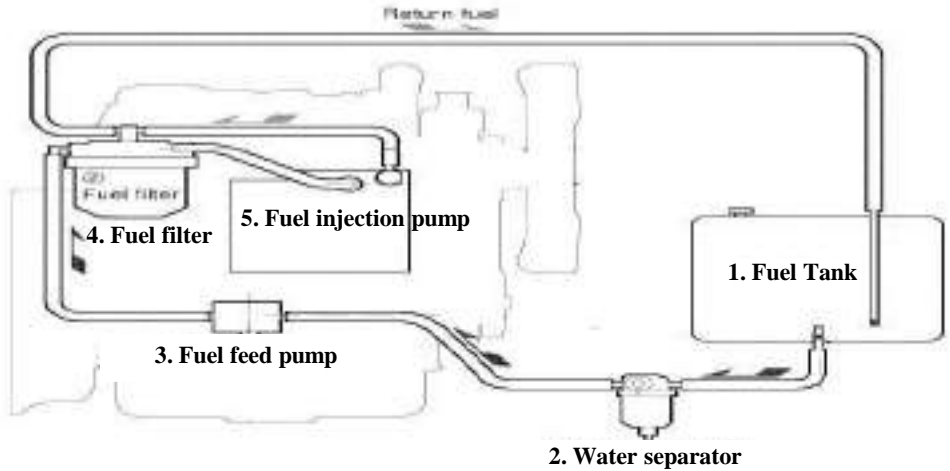

- 1) Fill the tank with fuel and turn the ignition key to on.
- 2) Loosen the air breather screw of the fuel filter two or three turns.
- 3) When fuel free from air flows (bubbles) from the Air breather screw, tighten the Air breath screw.
- 4) The bleeding of the system is now finished.

CLEANING OIL WATER SEPARATOR OF FUEL FILTER

If any foreign material or water is seen through the sight glass, remove it by performing the following steps

1. Prepare a container to collect fuel from the oil water separator.
2. Open the drain plug.
3. After a sufficient amount of fuel is drained, tighten the drain plug with a hand.
4. Do not use any tool.

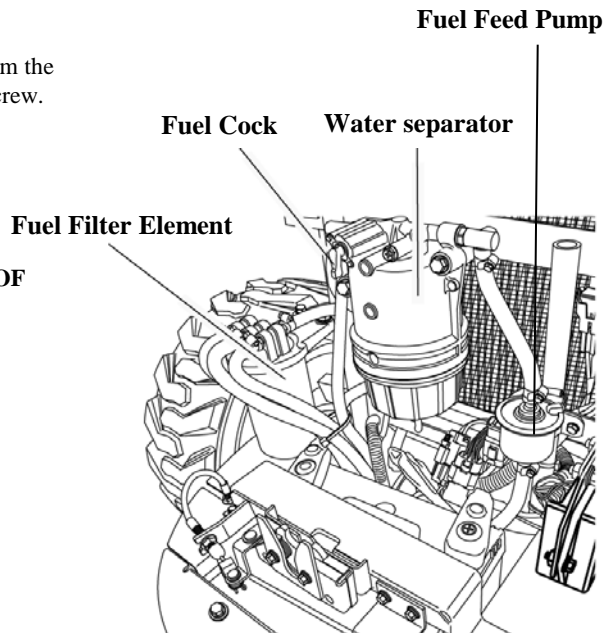

► **CHANGING THE OILS IN THE TRACTOR**

Always use quality oils as engine or transmission oil

Refer to the table on page 61 and 62 for the change frequency.

► **CHANGING ENGINE OIL**

Park tractor on level surface, shut-off engine.

Remove sump plug & drain oil.

Replace and check the sump plug and refill

the engine with oil to the correct level on the dipstick

(approx. 1.06 US gal)

The grade of oil to be used will depend on the ambient temperature.

The tractor is shipped from the factory with 15W/40.

For summer use over 77°F use SAE 30

For temperatures from 32°F-77°F use SAE20 or 15W/40.

For temperatures below 32°F use SAE 10W.

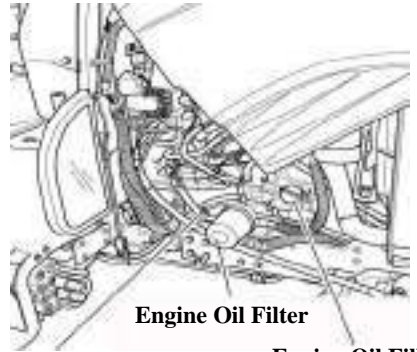

Engine Oil Gauge

Engine Oil Filler



important

When changing the oil always change the filter.

Always use the same oil, as using different oils or specifications can cause damage.

Dispose off the old oil as per local regulations.

► **CHANGING THE TRANSMISSION OIL**

1. Allow the transmission oil to cool.
2. Remove the drain plug from bottom of the transmission and drain the oil.
3. Replace and check the drain plug.
4. Refill the transmission to the correct level on the dipstick with new oil : Qty 35ℓ(9.25 US gal)

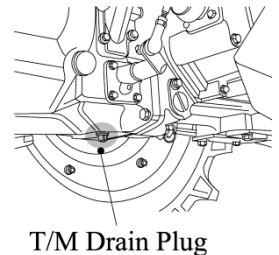
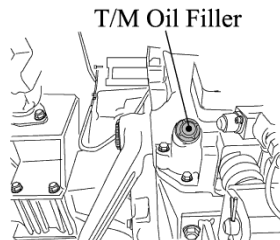
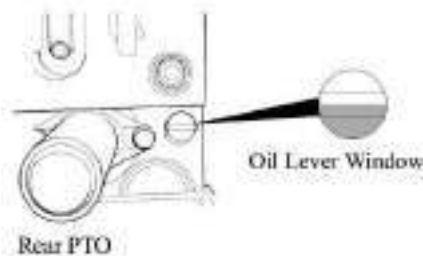

important

Always use the same grade and specified oil as Replacements.

Dispose off the old oil as per local regulations.

► CHANGING OIL IN THE FRONT AXLE

1. Drain the oil from the center diff plug and the drain plug in each drive.
2. Replace and tighten all drain plugs.
3. Remove the Fill/Lever Plugs from each final drive to vent air from final drives.
4. Remove the dip stick from the filter hole and fill with Front Axle Oil Capacity 8.2ℓ (2.17 US gal) and allow time for the oil to drain into the final drives.
5. Check the oil level with the dipstick and replace the Fill/Lever Plugs on both final drives and tighten

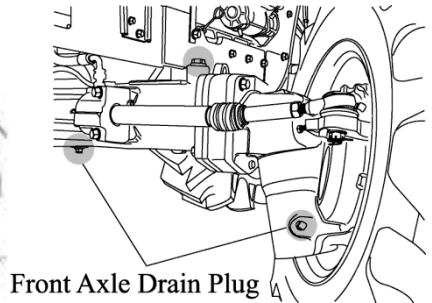
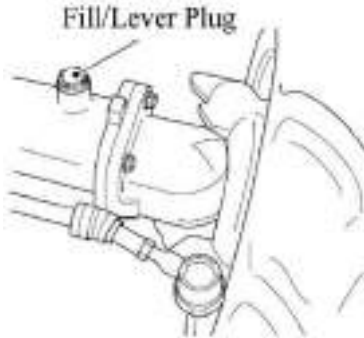
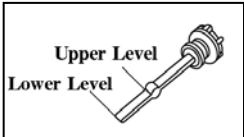

important

Some operators have found that when they fill with the correct amount of oil and dip it, the oil level on the dipstick is too high due to the fact that it takes a while for the oil to run into the final drives. Opening the Vent plugs helps to speed this up.

► CLEANING AND CHANGING FILTERS

► ENGINE OIL FILTER

Using a filter wrench turn the filter anti clockwise to remove it.

Lightly smear the rubber seal on the new filter with oil to ensure, turn it clockwise until the seal contacts the base and then turn it another 2/3 turn to tighten it.

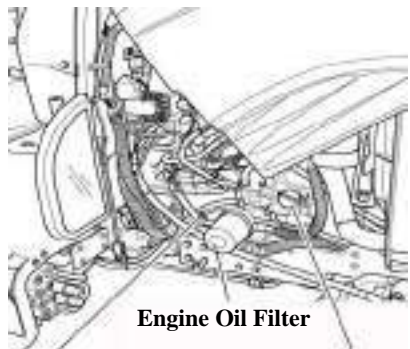

Engine Oil Gauge

Engine Oil Inlet

► HYDRAULIC OIL FILTER AND ENGINE OIL FILTER CARTRIDGE

Remove the filter with a filter wrench.

To replace, apply oil or grease on the seal, fit by hand until seal contacts bare, then turn it 2/3rd turn further to tighten it check for leaks.

► CHANGING THE COOLANT

- (1) Open the tap in front of the gear pump to drain the coolant.
- (2) Open the radiator cap at the same time.
- (3) To give a thorough clean run a hose into the radiator and flush it out.
- (4) Close the tap and refill the radiator with a coolant mixture of water and corrosion inhibitor or anti freeze.
- (5) Start the engine and allow it to run for approx 5 minutes, check the water level again and top up if required

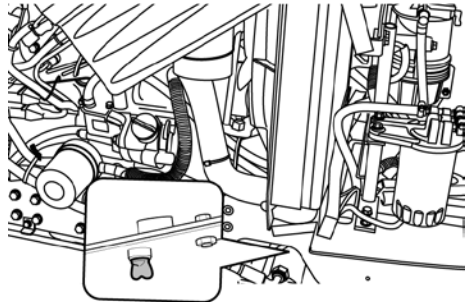
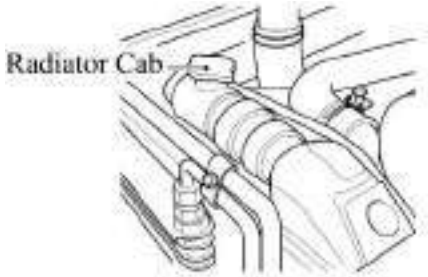

Caution

Do not remove the radiator cap on a hot engine.
Allow the engine to cool down and then turn the cap slowly to ensure, that there is no excessive pressure in the radiator.



Caution

Serious burns, can result from the contents of pressurized, hot radiators.
Allow the engine to cool down completely before opening radiator cap.

► ANTI FREEZE

Frozen cooling water can damage the engine.

Before replacing the anti freeze solution flush the radiator.

Mix the anti freeze solution in accordance with the instructions applicable to the brand of anti freeze and the locals climate.

Replace the solution in the radiator.

In case of loss of solution due to evaporation or overflow, replace with the original mixture ratio.



important

Water or air under high pressure can distort the cooling fins on the radiator and reduce its efficiency.

► GREASING THE TRACTOR

Grease the tractor according to the service schedule (page 65)

Ensure that grease nipples are cleaned well before any attempt is made to grease them.

* Clutch

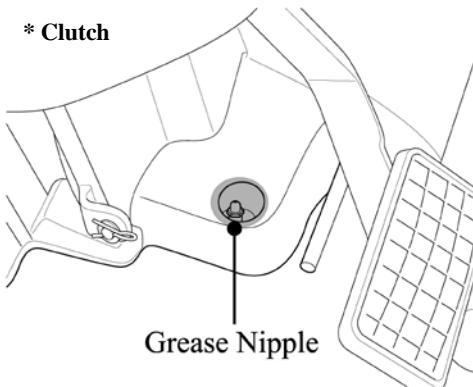

Grease Nipple

* Brake Pedal Rod

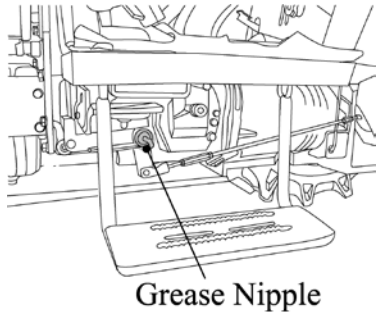

Grease Nipple

* Pivot Metal

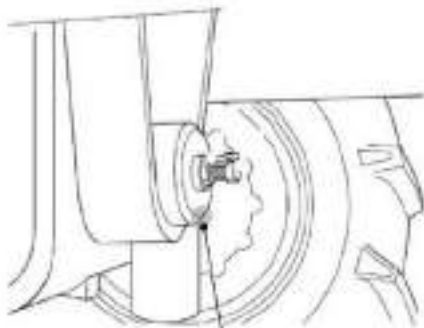

Grease Nipple

* Front Axle Ball Joint

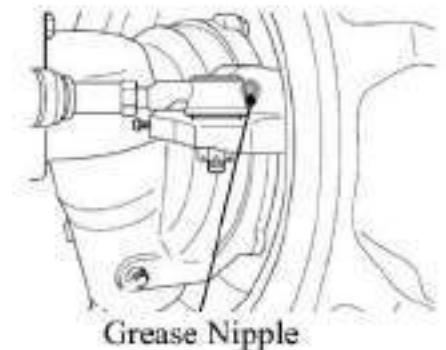

Grease Nipple