

Form No.
908305
English

CTL60 CTL70 CTL80

Compact Track Loader

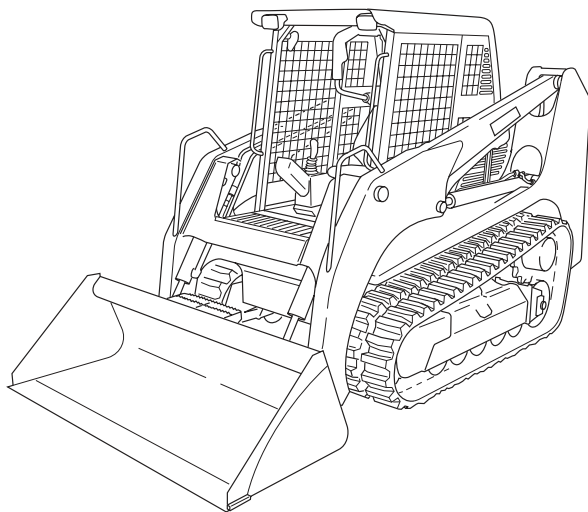

OPERATOR'S MANUAL

CEHL[®]





SAFETY ALERT SYMBOL

This symbol means Attention! Be Alert! Your Safety Is Involved. The message that follows the symbol contains important information about safety.

Read and understand the message to avoid personal injury or death.

- **It is the owner or employer's responsibility to fully instruct each operator in the proper and safe operation of all equipment. All persons using this machine should thoroughly familiarize themselves with the following sections.**
- **All operators must be instructed on the proper functions of the loader before running the machine.**
- **Learn and practice correct use of the machine controls in a safe, clear area before operating this machine on a job site.**

 CAUTION	
	<p>Improper operation, inspection and maintenance of this machine can cause injury or death.</p> <p>Read and understand this manual before performing any operation, inspection or maintenance on this machine.</p>

- **Always store this manual near at hand preferably on the machine itself. If it should be lost or damaged, immediately order a new one from your Gehl dealer. When transferring ownership of this machine, be sure to provide this manual to the next owner.**
- **Gehl Company supplies machines complying to the local regulations and standards of the country of export. If your machine has been purchased in another country or from a person or company of another country, it may not have the safety devices or safety standards required for use in your country. Should you have any question about whether your machine complies with the regulations and standards of your country, contact a Gehl dealer.**
- **Please note that the contents and diagrams included in this manual may not match your machine exactly.**

It is your responsibility to observe all pertinent laws and regulations and to follow the manufacturer's instructions on machine operation, inspection and maintenance.

Virtually all accidents occur as the result of a failure to observe basic safety rules and precautions. An accident can often be avoided by recognizing potentially hazardous situations beforehand. Read and understand all of the safety messages which explain how to prevent these accidents from occurring. Do not operate the machine until you are sure that you have gained a proper understanding of its operation, inspection and maintenance.

■ SIGNAL WORDS

Safety messages appearing in this manual and on machine decals are identified by the words "DANGER", "WARNING" and "CAUTION". These signal words mean the following:

 DANGER
The word "DANGER" indicates an imminently hazardous situation which, if not avoided, can result in serious injury or death.

 WARNING
The word "WARNING" indicates a potentially hazardous situation which, if not avoided, could result in serious injury or death.

 CAUTION
The word "CAUTION" indicates a potentially hazardous situation which, if not avoided, may result in minor or moderate injury.



IMPORTANT: The word "IMPORTANT" is used to alert against operators and maintenance personnel about situations which can result in possible damage to the machine and its components.



It is impossible to foresee every possible circumstance that might involve a potential hazard. The warnings in this manual or on the machine can not cover all possible contingencies. You must exercise all due care and follow normal safety procedures when operating the machine so as to ensure that no damage occurs to the machine, its operators or other persons.

■ EXPLANATION OF GRAPHICAL SYMBOLS

Following is an explanation of symbols used in this manual.

 , X prohibition

 /  Lock

 /  Unlock

INTRODUCTION

Foreword

This manual describes operation, inspection and maintenance of the machine, as well as safety instructions to be heeded during these operations.

If you have any questions about the machine, please contact a Gehl sales or service outlet.

■ Manual storage

A compartment for storing this manual is provided at the position shown on the diagram below.

1. Insert the starter key and turn it counterclockwise to unlock the cover (1).
2. Open the cover (1).
3. After using the manual, place it in the plastic pouch and store it back in the manual storage.

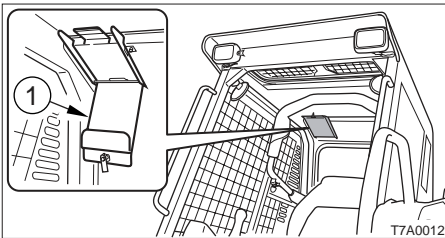

■ Serial numbers

Check the serial numbers of the machine and the engine and write them in the spaces provided below.

Machine number :

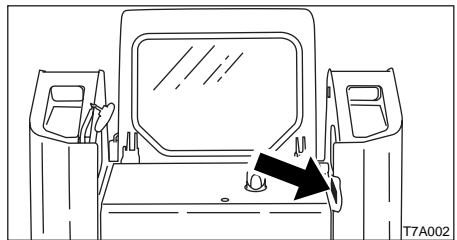

Engine number :



MACHINE DESCRIPTION

■ Front, rear, left and right

This manual refers the front, rear, left and right of the machine as seen when sitting in the operator's seat with the bucket visible to the front.

■ Designated operations

Use this machine primarily for the following operations:

- Carrying
- Leveling
- Loading

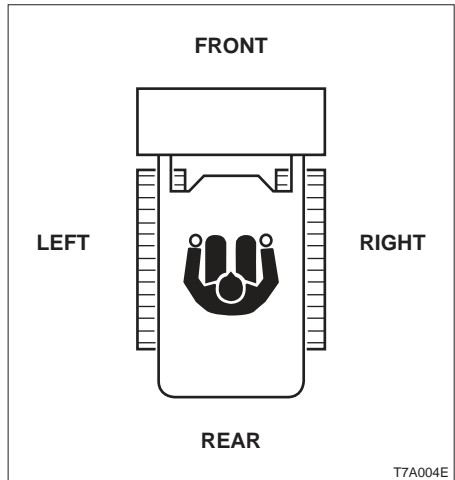

■ Features

- Hydrostatic drive system.
- Roll Over / Falling Object Protective Structure (ROPS/FOPS) tilt-up ROPS.
- Rubber crawlers combine the capabilities of a crawler loader.
- Low engine noise and exhaust emissions.
- Two-way auxiliary hydraulics.
- Pilot operated joystick controls.
- Engine emergency stop system.









■ Break-in period

When the machine is new, heed the instructions below when operating the machine for the first 100 hours (as indicated on the hour meter).

Using a new machine roughly without breaking it in will lead to quicker deterioration of machine performance and may shorten the machine's service life.

- Warm up the engine and hydraulic oil sufficiently.
- Avoid heavy loads and rapid operations. Operate with a load of about 80% the maximum load.
- Do not start up, accelerate, change directions, or stop abruptly unless necessary.

CONTENTS

Introduction	2
Machine Description	3
 Safety	7
 Controls	35
 Operation	57
 Transport	83
 Maintenance	87
 Troubleshooting	133
 Specifications	147
 Options	157
 Index	161



SAFETY

General Precautions	8
Preparing Precautions	12
Starting Precautions	14
Operating Precautions	16
Stopping Precautions	23
Transporting Precautions	24
Maintenance Precautions	25
Safety Signs (Decals)	32



SAFETY

General Precautions

Observe all safety rules

- Operation, inspection and maintenance of this machine must be performed only by a trained and qualified person.
- All rules, regulations, precautions and safety procedures must be understood and followed when performing operation, inspection and maintenance of this machine.
- Do not perform any operation, inspection and maintenance of this machine when under the adverse influence of alcohol, drugs, medication, fatigue, or insufficient sleep.

Wear appropriate clothing and personal protective equipment



- Do not wear loose clothing or any accessory that can catch on controls or in moving parts.
- Do not wear oily or fuel stained clothing that can catch fire.
- Wear a hard hat, safety shoes, safety glasses, filter mask, heavy gloves, ear protection and other protective equipment as required by job conditions. Wear required appropriate equipment such as safety glasses and filter mask when using grinders, hammers or compressed air, as metal fragments or other objects can fly and cause serious injury.

- Use hearing protection when operating the machine. Loud prolonged noise can cause hearing impairments, even the total loss of hearing.

Provide a fire extinguisher and first aid kit



- Know where a fire extinguisher and first aid kit are located and understand how to use them.
- Know how to contact emergency assistance and first aid help.

**Never remove safety equipment**

- Make sure all protective guards, canopies, doors, etc., are in place and secure. Repair or replace damaged components before operating the machine.



- Know how to use the safety bar, seat belt and other safety equipment and use them properly.
- Never remove any safety equipment except for service. Keep all safety equipment in good operating condition.

**Crush Hazard
FOPS Limitations**

Various classes and sizes of off-road equipment operate in a wide variety of applications and environmental conditions. With the intention of providing operators with reasonable protection from falling objects, two levels of FOPS (Falling-Object Protective Structure) acceptance criteria have been developed based on end use:

- Level 1 protection from falling bricks, small concrete blocks and hand encountered in operations such as highway maintenance, landscaping and other construction site services.

- Level 2 protection from falling trees or rocks for machines involved in site clearing, overhead demolition or forestry.

This machine is equipped with a Level 1 FOPS as standard equipment. DO NOT use this machine in an application that may involve the hazards of falling trees or rocks. If Level 2 FOPS protection is required in your application, contact your dealer or the manufacturer concerning the possible availability of such protection.

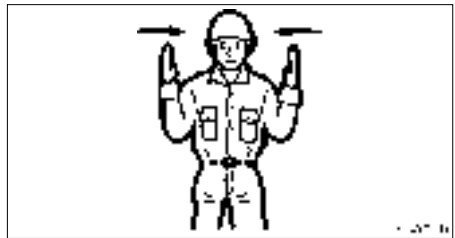
Use a signal person and flagman

Know and use the hand signals required for particular jobs and make sure who has the responsibility for signaling.

- All personnel must fully understand all the signals.
- The operator shall respond to signals only from the appointed signal person, but shall obey a stop signal at any time from anyone.
- The signal person must stand in a clearly visible location when giving signals.

**Avoid fire and explosion hazards**

Keep flames away from fuel, hydraulic fluid, oil, grease and antifreeze. Fuel is particularly flammable and dangerous.

- When handling these combustible materials, keep lit cigarettes, matches, lighters and other flames or sources of flames away.
- Do not smoke or permit open flames while fueling or near fueling operations.
- Never remove the fuel cap or refuel with the engine running or hot. Never allow fuel to spill on hot machine components.
- Clean up spilled fuel, oil or other flammable fluids immediately.
- Check for fuel, oil or hydraulic fluid leaks. Stop all leaks and clean the machine before operating.
- Do not cut or weld on pipes or tubes that contain flammable fluids. Clean thoroughly with nonflammable solvent before cutting or welding.
- Remove all trash or debris from the machine. Make sure that oily rags or other flammable material are not stored on the machine.
- Handle all solvents and dry chemicals according to procedures identified on manufacturers' containers. Work in a well-ventilated area.
- Never use fuel for cleaning purposes. Always use a nonflammable solvent.
- Store all flammable fluids and materials in a safe and well-ventilated place.

Exhaust fumes from the engine can kill

- Do not operate the engine in an enclosed area without adequate ventilation.
- If natural ventilation is poor, install ventilators, fans, exhaust extension pipes or other artificial venting devices.

Handling asbestos dust

Inhaling asbestos dust has been linked to lung cancer. When handling materials which may contain asbestos, take the following precautions:

- Never use compressed air for cleaning.
- Avoid brushing or grinding of the materials.
- For clean up, use wet methods or a vacuum equipped with a high efficiency particulate air (HEPA) filter.
- Wear an approved respirator if there is no other way to control the dust. When working indoors, install a ventilation system with a macro molecular filter.



SAFETY

General Precautions

Be careful not to get crushed or cut

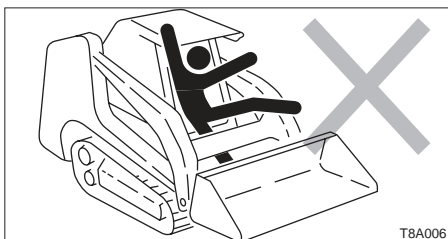
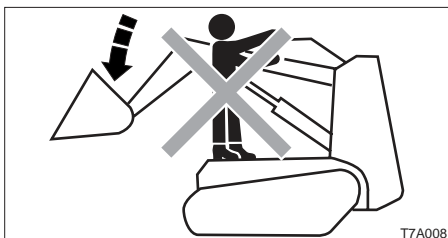
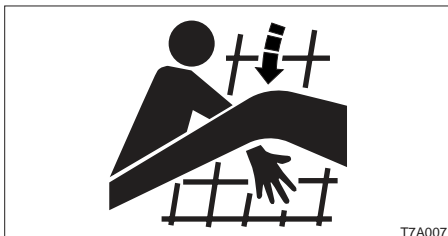

- Your body, hands or feet must not enter between moving parts such as between lift arms and main body, or between lift arms and bucket. When operating lift arms and bucket, the gap between the moving parts will be changing and getting caught in between can cause serious injury or death .
- The lift arms move close to the outside of the grid; never stick out arms or other portions of your body from the grid.
- The lift arms move close to the ROPS; therefore, do not stand or lean on the machine.

Using optional products

- Consult with a Gehl dealer before installing optional attachments.
- Do not use attachments that have not been approved by Gehl or a Gehl dealer. Doing so may compromise safety or adversely affect the machine's operation or service life.
- Gehl will not be held responsible for any injuries, accidents or damage to its products caused by the use of a non-approved attachment.

Never modify the machine

Unauthorized modifications to this machine can cause injury or death. Never make unauthorized modifications to any part of this machine.

**Know the working area**

Before starting operation, know the working area to ensure safety.

- Check the topography and ground condition of the working area, or the structure of the building when working indoors, and take the necessary safety measures in dangerous spots.
- Note and avoid all hazards and obstructions such as ditches, underground lines, trees, cliffs, overhead electrical wires or areas where there is danger of a slide.

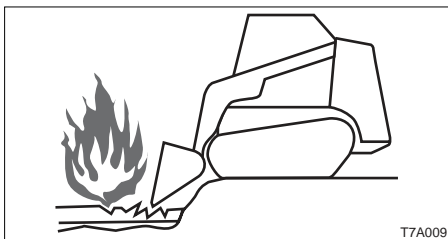

- Check with the local utilities for the locations of buried gas and water pipes and buried power cables. Determine jointly what specific precautions must be taken to insure safety.
- When working on roads, be sure to take into account the safety of pedestrians and vehicles.
 - Use a flagman and/or signals.
 - Fence off the working area and prohibit entry to unauthorized persons.
- When working in water or crossing shallow streams or creeks, check the depth of the water, the solidity of the ground, and the speed of the current beforehand. Make sure the water is not deeper than the allowable depth.

Refer to the section titled “Cautions on Use in Water” for further instructions.

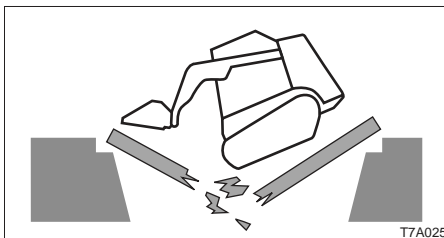
Check the strength of the bridge

When travelling over a bridge or other structure, check the permissible load. If the strength is insufficient, reinforce it.

Always keep the machine clean

- Clean windows, mirrors and lights to ensure good visibility.
- Wipe off any oil, grease, mud, snow or ice, to prevent accidents due to slipping.
- Remove all loose objects stored in the machine and all objects which do not belong in or on the machine and its equipment.
- Remove any dirt, oil or grease from the engine area, to prevent fires.
- Clean the area around the operator's seat, removing any potential obstacles.



Perform inspection and maintenance daily



Failure to notice or repair machine irregularities or damage can lead to accidents.

- Before operating, perform the prescribed inspections and make repairs immediately should any irregularities be found.
- If a failure that causes loss of control such as steering, service brakes or engine occurs, stop the machine motion as quickly as possible, follow the shutdown procedure, and keep machine securely parked until the malfunction is corrected.

Emergency Exit

If you should become trapped inside the cab, remove the rear window to get out.

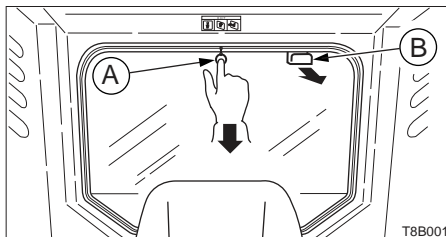

There are two ways to remove the rear window.

In case of emergency

1. Kick off the rear window. Note that the glass may break. Be careful not to get injured.

In case of need

1. Pull off ring (A) and remove the tip of the rubber wedge.
2. Grasp the tip, pull, and remove the entire rubber wedge.
3. Pull inside knob (B).



Maintain three point contact when mounting and dismounting

- Do not jump on or off the machine. Never attempt to mount or dismount a moving machine.
- When mounting and dismounting the cab, first open the door fully to the locked position and check that it does not move. (For machines with cab)



- Always face the access system and maintain a three point contact with the recommended handrails and steps while getting on and off the machine. Keep steps and platform clean.
- Never use the control levers as hand holds.
- Do not go under the raised lift arms if they are not sufficiently supported. Lower the lift arms to the ground before mounting or dismounting the cab.

Clear the area of other persons before starting the machine

Do not start the engine until you are sure it is safe. Before starting, check or perform the following.

- Walk around the machine and warn all personnel who may be servicing the machine or are in the machine path. Do not start until all personnel are clearly away from the machine.
- Check for any “DO NOT OPERATE” tags or similar warning notices on the cab door, controls or starter switch.
- Sound horn to alert everyone around the machine.

Start the engine from the operator’s seat

- Adjust, secure and latch the operator’s seat.



- Fasten the seat belt.
- Check that the parking device is applied and place all controls in the neutral position.
- Check that the safety bar is in the lock position.
- Clear the area of all persons.
- Start and operate the engine from the operator’s seat only.
- Never attempt to start the engine by shorting across the starter terminals.

**Starting with jumper cables**

Use jumper cables only in the recommended manner. Improper use of jumper cables can result in battery explosion or unexpected machine motion.

Refer to the section titled "If the Battery Goes Dead" for proper instructions.

After starting the engine

After starting the engine, perform the following operations and checks in a safe place with no persons or obstacles in the area. If any malfunctions are found, follow the shutdown procedure and report the malfunction.

- Warm up the engine and hydraulics.
- Observe all gauges or warning instruments for proper operation.
- Listen for unusual noises.
- Test engine speed control.
- Operate each control to insure proper operation.

In cold weather

- Be careful of slippery conditions on freezing ground, steps and hand holds.
- In severe cold weather, do not touch any metal parts of the machine with exposed flesh, as flesh can freeze to the metal and Cause injury.
- Do not use ether or starting fluids on this engine. These starting aids can cause explosion and serious injury or death.
- Warm up the engine and hydraulic fluid before operating.

**Ensure good visibility**

- When working in dark places, turn on the machine's working lights and headlights and/or provide extra stationary lighting if necessary.
- When visibility is poor due to severe weather (fog, snow or rain), stop operating the machine and wait until conditions improves.

Do not permit riders on the machine

- Do not allow anyone to ride on any part of the machine at any time while traveling.
- Do not allow anyone to be on any part of the machine while operating.

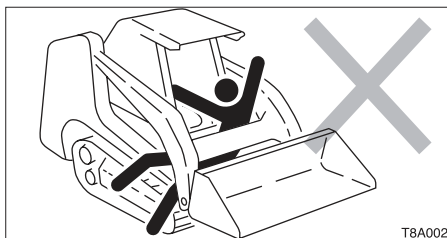
Operate the machine only from the operator's seat

Operate all the controls only from the operator's seat. Failure to do so can cause serious injury or death.

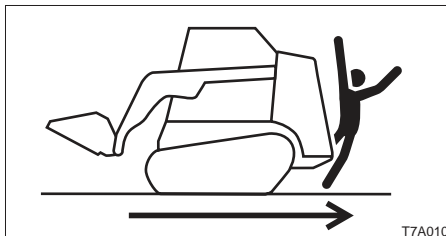
Check for safety in the surrounding area before starting

- Understand the machine limitations.
- Use a signal person where clearances are close or your vision is obstructed.
- Never allow anyone to enter the turning radius and machine path.
- Signal your intention to move by sounding the horn.
- There are blind spots to the rear of the machine.

If necessary, before backing up to check that the area is safe and clear.

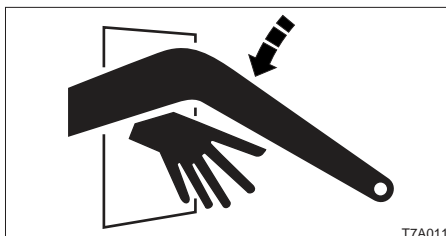
Keep your body inside the operator's cab

Keep your body inside the operator's cab while operating the loader. Never work with your arms, feet or legs beyond the operator's compartment.

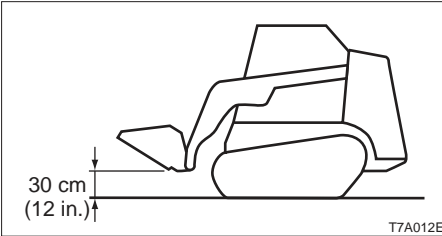
**Cautions on traveling and turning**

- Traveling and turning should be performed with the bucket cylinder fully retracted and the bucket at a height of approximately 30 cm (12 in.) from the ground.
- Avoid sudden stops, start or turns.
- Do not raise the safety bar while traveling. This is dangerous, since raising the safety bar will cause the parking brake of the traveling motor to operate and apply the brake abruptly.
- Do not switch off the starter switch while traveling. Doing so will cause sudden braking and is dangerous.
- Before backing up, visually check for safety to the rear. Backing up without checking could result in contact with a worker or obstacle.
- If unavoidable while traveling, when operating the working equipment, do so with care.

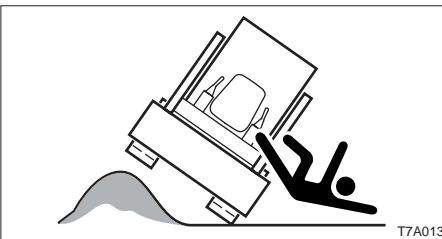

- When traveling, try not to cross over obstacles. When crossing over something cannot be avoided, maintain the bucket close above the ground and travel slowly.

Also note that the machine must not cross over an obstacle with the machine body on an extreme slant (of 15 degrees or more).

- When traveling on rough terrain or when carrying a load, lower the load and travel slowly.

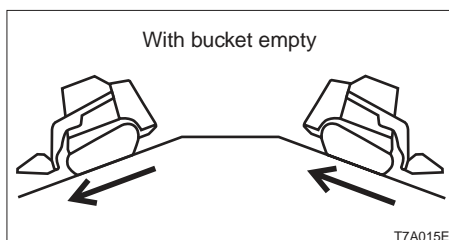
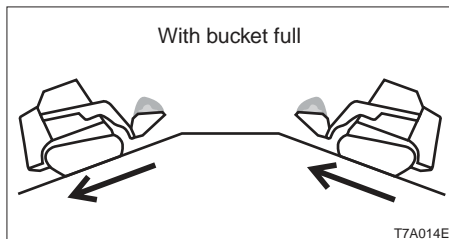
**Cautions on traveling on slopes**

Work should not be performed on a slope since the balance of the machine can be lost when operating the working equipment and there is the danger of the machine tipping over.

When traveling on a slope, be cautious of tipping over or sliding sideways.

When traveling on a slope, have the heavier end of the machine (front or back, whichever is heavier) pointing up the slope.

- When going up or down slopes having a gradient of 15 degrees or more, travel up and down slope with the heavy end of the machine pointed uphill.
- When traveling on a slope, lower the bucket to a height of 20 to 30 cm from the ground and at the time of an emergency, lower the bucket to the ground and stop the machine.
- Travel at slow speed on slopes. Especially when going down slopes, reduce the engine (r.p.m.) speed and set the stroke of the left control lever to half or less before going down. Going down a slope too fast will lead to loss of control.

- Sudden stopping on a sloped road may lead to loss of balance of the machine and it could tip over.

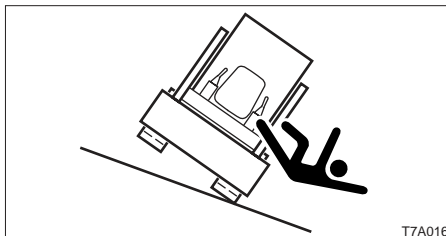

- Traveling across an inclined surface at an angle or traveling straight across an inclined surface could result in slipping sideways or tipping over. Travel straight up and down the slope.
- When traveling over grass or fallen leaves, wet iron plate or frozen surfaces, the machine might unexpectedly slide sideways even when on a slight slope. Do not allow the machine to become oriented across the slope.

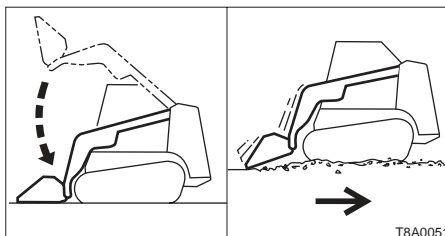
Use caution when floating the lift arms

- Make sure the bucket is lowered on the ground before floating the lift arms. Floating the lift arms while they are raised will cause the bucket to fall and is extremely dangerous.
- Do not drive the loader forward with the lift arms in Float position.



Do not drive into materials at high speed

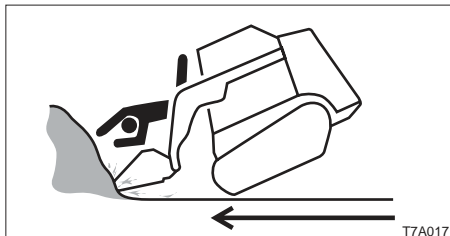

Driving at high speed into the materials you are handling can lead to your body bumping into the machine or being thrown from the machine. Check the conditions surrounding the area in front of the material you are handling and work at low speeds.

Do not carry the bucket over the heads of people

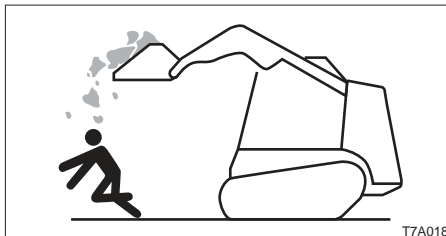

Carrying the bucket over the heads of people entails the danger of the load spilling or the sudden dropping of the bucket.

Operate on snow or ice with extra care

- When traveling on snow or frozen surfaces, keep the machine travel speed down and avoid accelerating, stopping or changing directions abruptly.
- Remember that the road shoulder, fences, etc., may be buried in the snow and not visible.
- Lower the bucket when parked on unsure ground conditions.

Caution against the falling of an unstable load

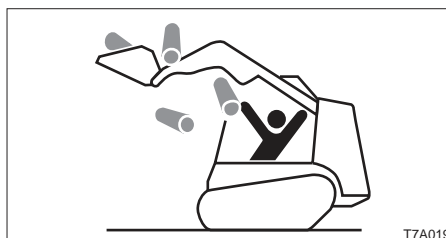

Unstable loads such as round items, cylindrical items, and stacked plates entail the possibility of falling from the bucket. When handling unstable loads, operate carefully so as not to raise the bucket too high or tilt too far backward.

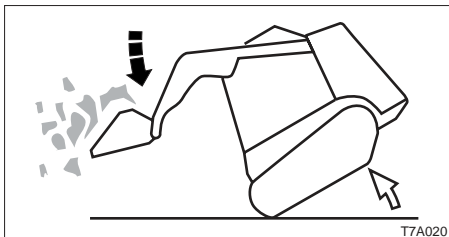
**Do not suddenly stop or lower the working equipment**

Sudden lowering or stopping of the working equipment could cause the machine to tip over due to the reaction.

Especially when the bucket is loaded, operate the working equipment carefully.

Avoid overloading and off-center loads

Filling the bucket in excess of the maximum load and loading an off-center load will cause the machine to become unstable and could result in the machine tipping over. Loading should be less than the maximum load (CTL60: 735 kg or 1620 lb. / CTL70: 945 kg or 2083 lb. / CTL80: 1120 kg or 2470 lb.) and should be done evenly.

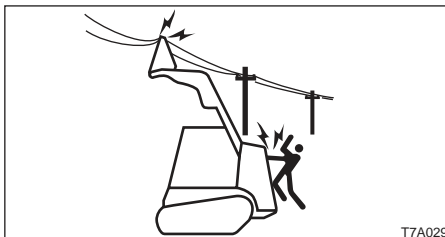
Keep a safe distance from electrical power lines

Never approach power lines with any part of the machine and its load unless all local and national required safety precautions have been taken. Electrocutation and death can result from arcing, touching or even being close to a machine that is in contact with or near an electrical source.

- Maintain the maximum possible distance from power lines and never violate the minimum clearance.
- Always contact the nearest electric utility and determine jointly what specific precautions must be taken to insure safety.
- Consider all lines to be power lines and treat all power lines as energized even though it is known or believed that the power is shut off and the line is visibly grounded.
- Use a signal person to observe the approach of any part of the machine or load to the power line.
- Caution all ground personnel to stand clear of the machine and the load at all times.
- If the machine should come in contact with a live electrical source, do not leave the operator's seat. Do not allow anyone to approach or touch the machine.
- Be especially careful of buried high voltage power lines.

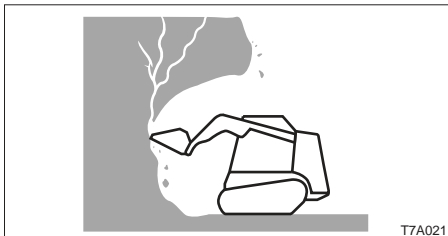
**Watch out for hazardous working conditions**

- Never undercut a high bank. Be particularly alert for the possibility of a cave-in.
- Do not operate in places where there is a danger of falling rocks.
- Do not approach unstable surfaces (cliffs, road shoulders, deep trenches, etc.). The ground may give way under the machine's weight or vibrations, causing the machine to tip over.
 - The ground is weak after rain or explosions.
 - The ground is also unstable on banks and near dugout trenches.

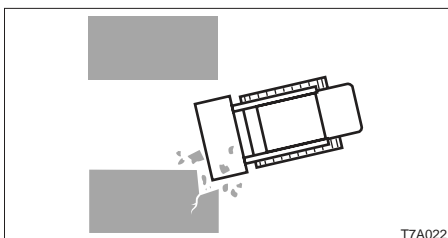
Travel in narrow or congested places

To avoid contact accidents, pay attention to the surroundings at narrow sites, indoors, and congested places and operate at a speed at which the machine can be safely operated.

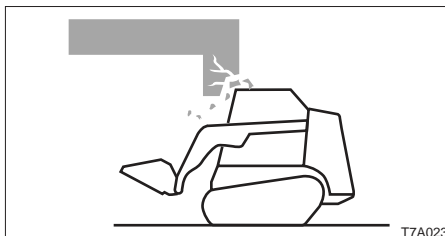
Precautions when passing through tunnels or by high walls

Careless entry into tunnels or places with high walls can lead to serious accidents such as contact accidents, etc. Check height and width limits in advance and verify that the machine is within the limits.

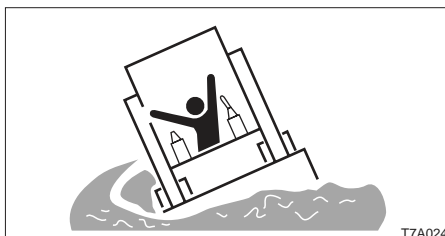
Do not enter soft ground

Entry onto soft ground can result in the machine tilting on its own weight, tipping over, or falling in. Do not enter weak ground such as that following back-filling.



Loaders are NOT designed for lifting loads

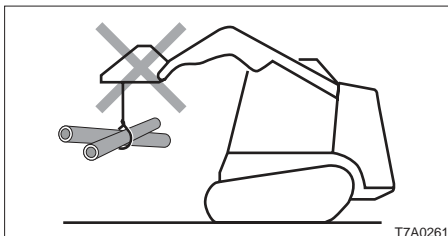

The machine is NOT specifically designed for lifting loads work and has no safety devices for crane operation.

Danger of flying objects

- This machine is not equipped with protective guards to protect the operator from flying objects. Do not use the machine in places where there are risks of the operator being hit by flying objects.

Cautions on Towing

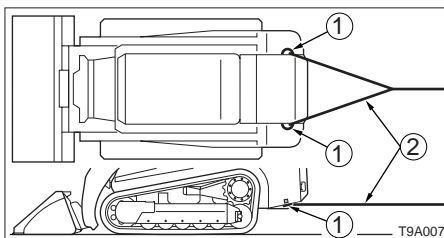

When towing, selecting the wrong wire rope, inspecting improperly, or towing in the wrong way could lead to accidents resulting in serious injury or death.

- The wire rope breaking or coming detached could be extremely dangerous. Use a wire rope suited for the required towing force.
- Do not use a wire rope that is kinked, twisted or otherwise damaged.
- Do not apply strong loads abruptly to the wire rope.
- Use safety gloves when handling the wire rope.
- Make sure there is an operator on the machine being towed as well as on the machine that is towing.
- Never tow on slopes.
- Do not let anyone near the wire rope while towing.

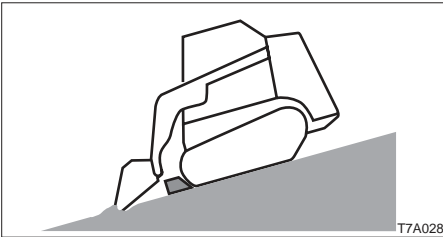
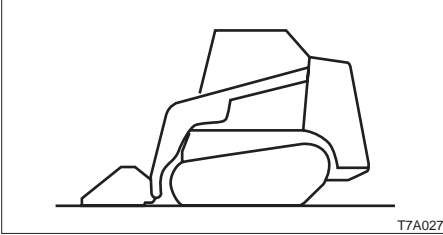
**Park safely**

- Park the machine on firm, level ground and apply the parking device. If you must park on a slope or incline, block the machine securely to prevent movement.
- When parking on streets, use barriers, caution signs, lights, etc., so that the machine can easily be seen even at night to avoid collision with other vehicles.

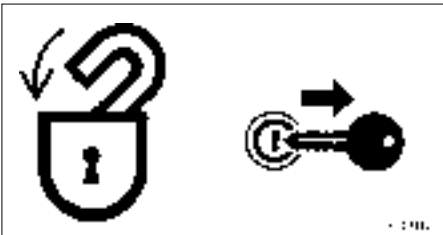

- Before leaving the machine, do the following:
 1. Lower the bucket to the ground.
 2. Set the safety bar in the lock position.
 3. Stop the engine and remove the key.
 4. Lock the covers.

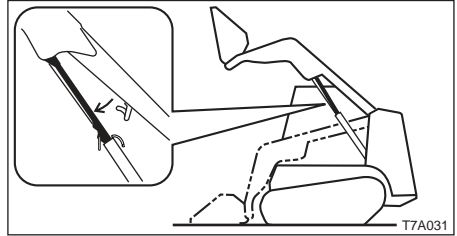

- Never leave the machine with the engine running or the lift arms raised, unattended. If arms are left in raised position, they **MUST** be restrained by the lift arm stop.

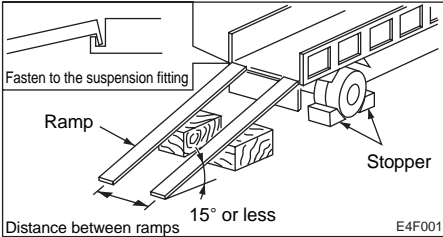
**Load and unload the machine safely**

The machine may roll or tip over or fall while loading or unloading it. Take the following precautions:

- Select a firm, level surface and keep sufficient distance from road shoulders.
- Use loading ramps of adequate strength and size. Maintain the slope of loading ramps within 15 degrees.
- Secure the ramps to the truck bed.
- Keep the truck bed and loading ramps clean of oil, clay, ice, snow, and other materials which can become slippery. Clean the tracks.
- Block the transport vehicle so it can not move.
- Use a signal person when loading and unloading the machine, and travel slowly in first gear (low speed).
- Never change course on the ramp.
- Do not turn on the ramps. The machine may tip over.
- Block both tracks and secure the machine to the truck bed with load binders.

Transport the machine safely

- Know and follow the safety rules, vehicle code and traffic laws when transporting the machine.
- Consider the length, width, height and weight of the truck with the machine loaded on it when determining the best route.

**Attach a “DO NOT OPERATE” tag**

Severe injury could result if an unauthorized person should start the engine or touch controls during inspection or maintenance.

- Stop the engine and remove the key before performing maintenance.
- Attach a “DO NOT OPERATE” tag to the starter switch or control lever.

Use the correct tools

Do not use damaged or weakened tools or tools designed for other purposes. Use tools suited for the operation at hand.

Replace important safety parts periodically

- Replace fuel hoses periodically. Fuel hoses become weaker over time, even if they appear to be in good shape.
- Replace important safety parts whenever an irregularity is found, even if it is before the normal time for replacement. Refer to the section titled “Important Parts” for further details.

Anti-explosive lighting

Use anti-explosive electrical fixtures and lights when inspecting fuel, oil, coolant, battery fluid, etc. If lighting that is not anti-explosive should break, the substance could ignite, resulting in serious injury or death.

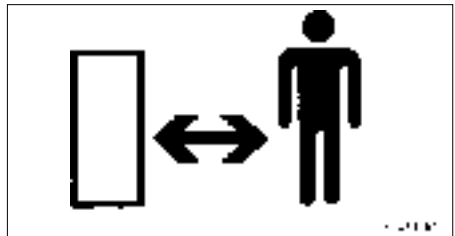
Do not allow unauthorized personnel in the work area

Do not allow unauthorized personnel in the work area. Chips or other debris can fly off machine parts when grinding, welding or using a hammer.



Prepare the work area

- Select a firm, level work area. Make sure there is adequate light and, if indoors, ventilation.
- Clear obstacles and dangerous objects. Eliminate slippery areas.

Stop the engine before performing maintenance

- Avoid lubrication or mechanical adjustments with the machine in motion or with the engine running while stationary.
- If maintenance must be performed with the engine running, always work as a two-person team with one person sitting in the operator's seat while the other works on the machine.
 - When performing maintenance, be sure to keep your body and clothing away from moving parts.

Always clean the machine



- Clean the machine before performing maintenance.
- Stop the engine and cover electrical parts when washing the machine. Water on electrical parts could cause short-circuits or malfunctions.
Do not use water or steam to wash the battery, sensors, connectors or the operator's compartment.

Stay clear of moving parts

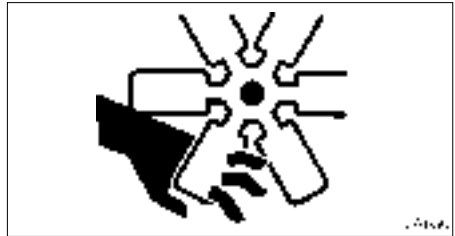

- Stay clear of all rotating and moving parts. Wrapping or entanglement may result in serious injury or death.
- Keep hands, clothing and tools away from the rotating fan and running fan belts.



SAFETY

Maintenance Precautions

Securely block the machine or any component that may fall



- Before performing maintenance or repairs under the machine, set the bucket against the ground or in the lowermost position.
- Securely block the tracks.
- If you must work beneath the raised machine or equipment, always use lift arm stop, jack-stands or other rigid and stable supports. Never get under the machine or working equipment if they are not sufficiently supported. This procedure is especially important when working on hydraulic cylinders.

Securely block the raised lift arms

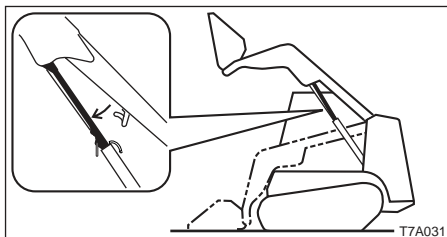

- If you must work beneath the raised lift arms, securely engage the lift arm stop. Never get under the lift arms and bucket if they are not sufficiently supported.
- Disconnecting or loosening any hydraulic line, hose, fitting or component or a parts failure can cause the lift arms to drop.

- Service the lift arm stop if damaged or if parts are missing. Using a damaged lift arm stop or with missing parts can cause the lift arms to drop causing injury or death.

Secure the rear door when opened

Be sure to secure the rear door when opening it. Do not open the rear door on slopes or in strong wind.

Cautions on tilting up the ROPS

- Raising or lowering the ROPS while the engine is running may cause the machine to move, and cause serious injury or death. Lower the working equipment to the ground and stop the engine before raising or lowering the ROPS.
- When the ROPS is tilted up, support it firmly with the stopper to prevent it from falling.

Place heavy objects in a stable position



When removing or installing the bucket or attachment, place it in a stable position so that it does not tip over.



Use caution when fueling



- Do not smoke or permit open flames while fueling or near fueling operations.
- Never remove the fuel cap or refuel with the engine running or hot. Never allow fuel to spill on hot machine components.
- Maintain control of the fuel filler nozzle when filling the tank.
- Do not fill the fuel tank to capacity. Allow room for expansion.
- Clean up spilled fuel immediately.
- Tighten the fuel tank cap securely. Should the fuel cap be lost, replace it only with the original manufacturer's approved cap. Use of a non-approved cap without proper venting may result in pressurization of the tank.
- Never use fuel for cleaning purposes.
- Use the correct fuel grade for the operating season.

Handling of hoses

Fuel, oil or hydraulic fluid leaks can cause a fire.

- Do not twist, bend or hit the hoses.
- Never use twisted, bent or cracked hoses, tubes and pipes. They may burst.
- Retighten loose connections.

Be careful with hot and pressurized components



Stop the engine and allow the machine to cool down before performing inspection and maintenance.

- The engine, muffler, radiator, hydraulic lines, sliding parts and many other parts of the machine are hot directly after the engine is stopped. Touching these parts will cause burns.
- The engine coolant, oil and hydraulic fluid are also hot and under high pressure. Be careful when loosening caps and plugs. Working on the machine under these conditions could result in burns or injuries due to the hot oil spurting out.



Be careful with hot cooling systems



Do not remove the radiator cap or drain plugs when the coolant is hot. Stop the engine, let the engine and radiator cool and loosen the radiator cap or drain plugs slowly.

Be careful with fluids under pressure

Pressure can be maintained in the hydraulic circuit long after the engine has been shut down.

- Release all pressure before working on the hydraulic system.



- Hydraulic fluid under pressure can penetrate the skin or eyes and cause injury, blindness or death. Fluid escaping from a small hole can be almost invisible. Wear a safety goggles and heavy gloves and use a piece of cardboard or wood to search for suspected leaks. If fluid is injected into the skin, it must be removed within a few hours by a doctor familiar with this type of injury.

Release all pressure before working on the hydraulic system

Oil may spurt out if caps or filters are removed or pipes disconnected before releasing the pressure in the hydraulic system.

- When removing plugs or screws or disconnecting hoses, stand to the side and loosen slowly to gradually release the internal pressure before removing.

Be careful with grease under pressure



The track adjuster contains highly pressurized grease. If the tension is adjusted without following the prescribed procedure, the grease discharge valve may fly off, resulting in injury.

- Loosen the grease discharge valve slowly.
- Do not put your face, arms, legs or body in front of the grease discharge valve.
- If no grease is expelled when grease discharge valve is loosened, there is a problem. Contact your nearest service outlet for repairs. DO NOT disassemble, as this is very dangerous.



Disconnect the battery



Disconnect the battery before working on the electrical system or doing any welding. Remove the negative (–) battery cable first. When reconnecting the battery, connect the negative (–) battery cable last.

Avoid battery hazards

- Batteries contain sulfuric acid which will damage eyes or skin on contact.
 - If acid contacts eyes, flush immediately with clean water and get prompt medical attention.
 - If acid is accidentally swallowed, drink large quantities of water or milk and call a physician immediately.
 - If acid contacts skin or clothing, wash off immediately with clean water.
 - Wear safety glasses and gloves when working with batteries.
 - Batteries generate flammable and explosive gases. Keep arcs, sparks, flames and lighted tobacco away.
 - Use a flashlight to check battery electrolyte level.
 - Stop the engine and shut off electrical equipment while inspecting or handling the battery.
 - Do not short circuit the battery posts with metal items.
- Always unfasten the negative (–) battery cable first when disconnecting the battery cable. Always connect the negative (–) battery cable last when fastening the battery cable.
 - Loose battery terminals may result in sparks. Be sure to fasten terminals tightly.
 - Make sure the vent caps are tightened securely.
 - Do not charge a battery or jump-start the engine if the battery is frozen. Warm to 15°C (60°F) or the battery may explode.
 - Do not use the battery when the fluid level is below the lower level. Doing so will hasten the deterioration of the internal portions of the battery and shorten the battery life, and can also cause rupturing (or an explosion).
 - Do not fill the battery above the upper level. Doing so could cause the fluid to leak, contact and damage the skin, or cause parts to corrode.



Have a Gehl service agent repair welding cracks or other damage

Ask a Gehl service agent to repair any welding problems which are detected. If not feasible, make sure the welding is done by a qualified person in a properly equipped workplace.

Checks after maintenance

- Gradually raise the engine speed from a low idle to maximum speed and check that no oil or air is leaking from serviced parts.
- Move the controls and check that the machine is operating properly.

Safety signs

- Keep all safety signs clean and legible.
- Replace all missing, illegible or damaged safety and warning signs.

Disposing of wastes

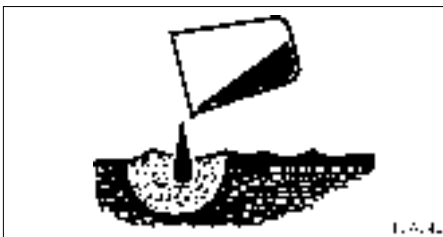

- Funnel spent fluids from the machine into containers. Disposing of fluids improperly destroys the environment.
- Follow the prescribed regulations when disposing of oil, fuel, engine coolant, refrigerant, solvents, filters, batteries or other harmful substances.



SAFETY

Safety Signs (Decals)

The following safety signs (decals) have been placed on your machine in the areas indicated. They are intended for the personal safety of you, and those working with you. Please take this manual, walk around your machine and note the content and location of these safety signs. Review these signs and the operating instructions in this manual with your machine operators.

- Keep the signs legible. If they are not, obtain replacements from your Service outlet.

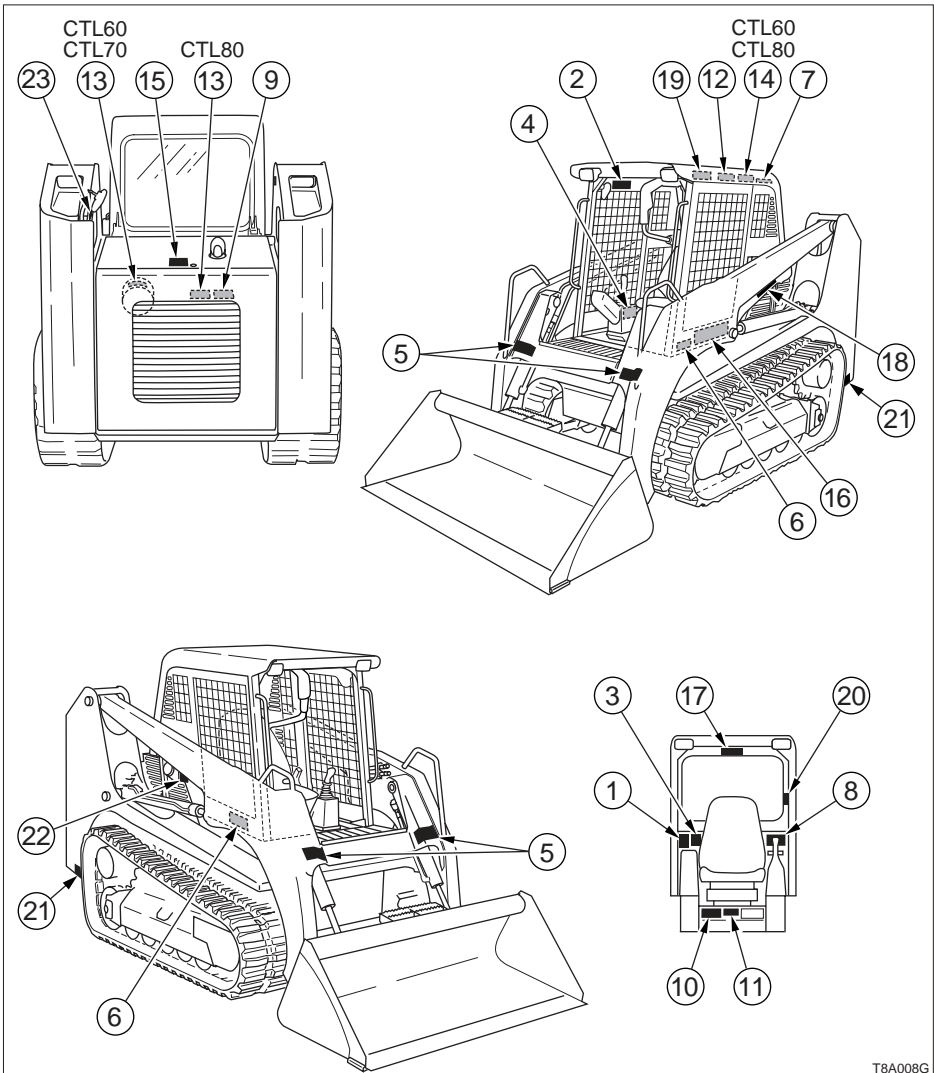

T8A008G



SAFETY

Safety Signs (Decals)

1.No.08800-30009

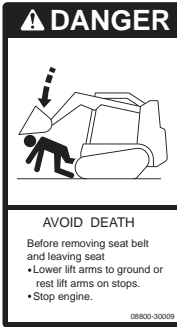

2.No.08800-30010



3.No.08800-30011



4.No.08800-31003



5.No.08800-30017



6.No.08800-31005



7.No.08810-30026



8.No.03593-13700



9.No.05693-21980



10.No.08810-30020



< CTL60 >

11.No.08800-38009



< CTL70 >

11.No.08820-30009



< CTL80 >

11.No.08810-30009





SAFETY
Safety Signs (Decals)

12.No.08800-30015



13.No.08800-30016



14.No.08800-31015



15.No.03593-07400



16.No.08810-30110

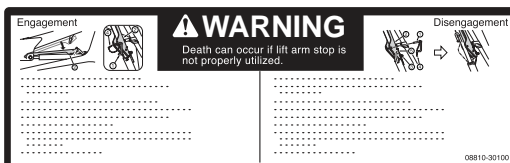

17.No.08800-31018

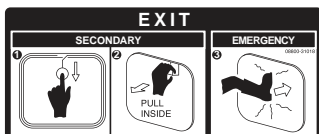

18.No.137637



19.No.08810-31551



20.No.03993-00400

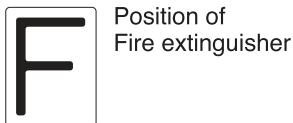

21.No.08810-31549



22.No.03593-06600



23.No.03593-06700

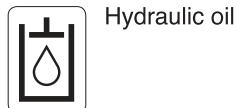



CONTROLS

Names of Components	36
Doors and Covers	38
Seat and Seat Belt	42
Instrument Panel	44
Switches	46
Levers and Pedals	50
Accessories	52

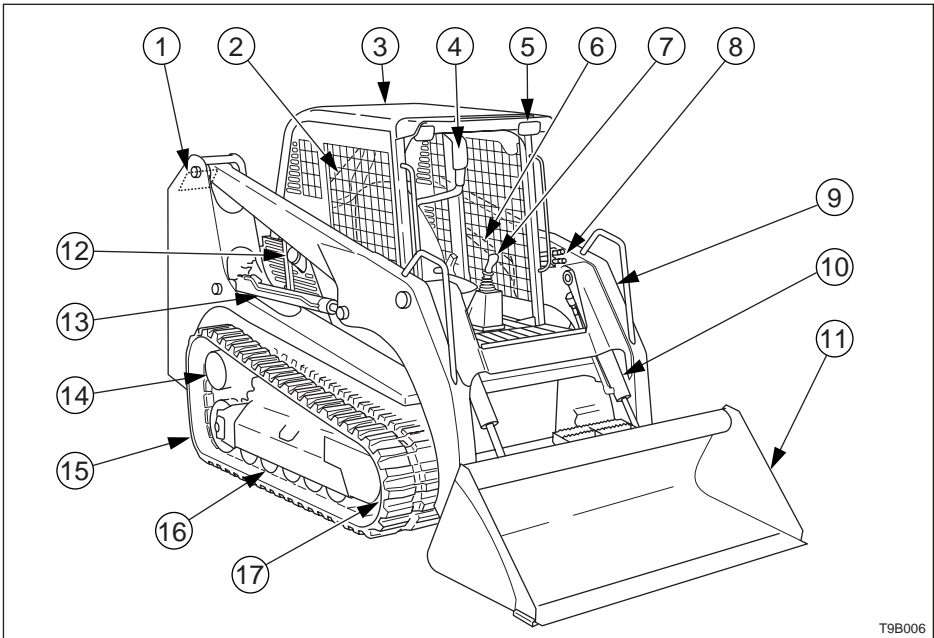

T9B006

- | | |
|------------------------------|---------------------|
| 1. Tail light | 10. Bucket cylinder |
| 2. Hydraulic tank | 11. Bucket |
| 3. ROPS | 12. Fuel filler cap |
| 4. Safety bar | 13. Arm cylinder |
| 5. Front light | 14. Travel motor |
| 6. Lift arm stop | 15. Crawler belt |
| 7. Left control lever | 16. Track roller |
| 8. Auxiliary hydraulic lines | 17. Idler |
| 9. Lift arm | |

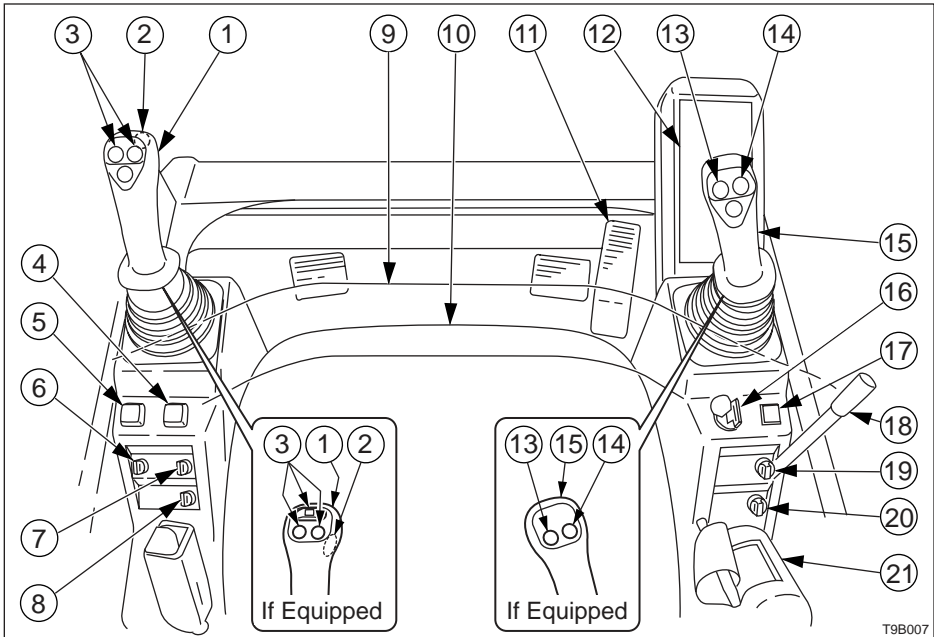

T9B007

1. Left control lever
2. Travel speed switch
3. Auxiliary hydraulic switches
4. Detent mode switch
(for auxiliary hydraulic switches)
5. Flow selector switch (2way → 1way)
6. Heater switch (option)
7. Front wiper switch (option)
8. Rear wiper switch (option)
9. Safety bar
10. Seat
11. Auxiliary pedal (If equipped)
12. Instrument panel
13. Float switch
14. Horn switch
15. Right control lever
16. Starter switch
17. High flow switch (option)
18. Throttle lever
19. Front light switch
20. Tail light switch
21. Seat belt



Starter Key

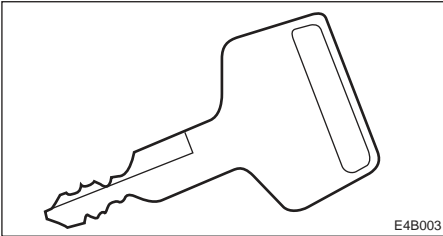

The starter key is used not only to start and stop the engine, but also to lock and unlock the following places:

- Fuel filler cap
- Engine hood
- Cab door
- Manual storage

Engine Hood

WARNING

Before opening the engine hood, be sure to stop the engine. If your hands or tools should get caught in the fan or fan belt while the engine is running they may be severed.

Opening

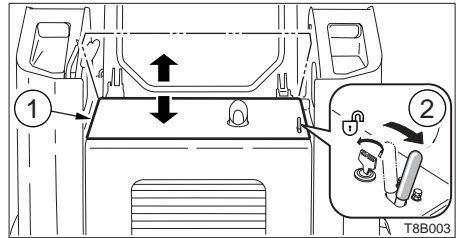

1. Insert the starter key and turn it counterclockwise to unlock the engine hood (1).
2. Remove the key and pull the lever (2) backward.
3. Lift the engine hood (1).

Closing

1. Close the engine hood and press it down until a click is heard at the front.
2. Insert the starter key and turn it clockwise to lock the engine hood.



Rear Door

CAUTION

- When opening the rear door, open it firmly to the locked position.
- When opening and closing the rear door, be careful not to get your hands or other parts of your body caught.

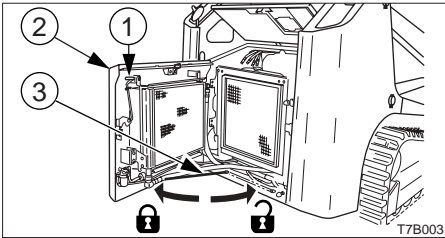

Opening

1. Open the engine hood.
2. Lift the lever (1) and open the rear door (2).
3. Release the stay (3), then insert and fix it into the stay hole of the rear door (2).

Closing

1. Support the rear door (2) by hand, remove stay (3), and fix it to the original position.
2. Close the rear door (2) and press it until a click is heard at the front.

Emergency Exit

If you should become trapped inside the cab, remove the rear window to get out.

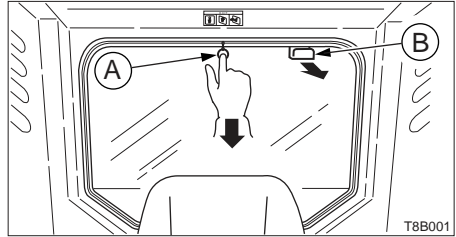

There are two ways to remove the rear window.

In case of emergency

1. Kick off the rear window. Note that the glass may break. Be careful not to get injured.

In case of need

1. Pull off ring (A) and remove the tip of the rubber wedge.
2. Grasp the tip, pull, and remove the entire rubber wedge.
3. Pull inside knob (B).



Lift Arm Stop

WARNING

- If you must work beneath the raised lift arms, securely engage the lift arm stop. Never get under the lift arms and bucket if they are not sufficiently supported.
- Service the lift arm stop if damaged or if parts are missing. Using a damaged lift arm stop or with missing parts can cause the lift arms to drop causing injury or death.

Maintenance and service work can be done with the lift arms lowered. If the lift arms are raised, use the following procedures to engage and disengage an approved lift arm stop.

Engagement

1. Park the machine on level ground and remove the bucket.
2. Lower the lift arms to the ground and stop the engine.

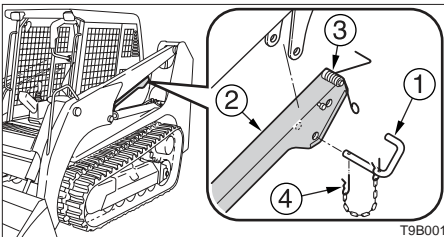

3. Remove the rear R-pin (4) from the locking pin (1).
4. Support the lift arm stop (2) by hand and pull out the locking pin (1).

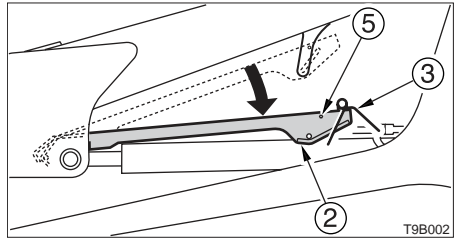

5. Check that the spring (3) moves freely (i.e., is disengaged from the hook (5)) and place the lift arm stop (2) on the cylinder.
6. Sit in the seat, fasten the seat belt, start the engine and lower the safety bar.
7. Raise the lift arms slowly until the lift arm stop (2) drops onto the cylinder rod.

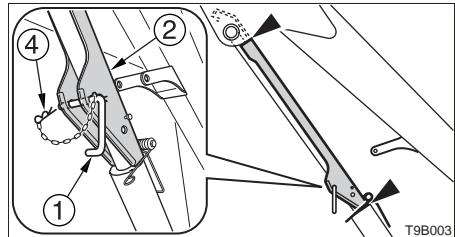

8. Lower the lift arms slowly until the lift arm stop is held between the lift arm and the end of the cylinder tube.
9. Stop the engine.
10. Install the locking pin (1) into the rear of the lift arm stop (2) below the cylinder rod.
11. Install the R-pin (4) to the locking pin (1).



Disengagement

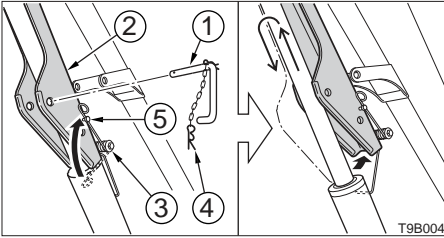

1. Remove the rear R-pin (4) from the locking pin (1).
2. Pull out the locking pin (1) from the lift arm stop (2).
3. Hook the end part of the spring (3) onto the hook (5) of the lift arm stop (2).
4. Sit in the seat, fasten the seat belt, start the engine and lower the safety bar.
5. Raise the lift arms slowly until the spring (3) will lift the lift arm stop (2) off the cylinder rod.
6. Lower the lift arms slowly to the ground and stop the engine.

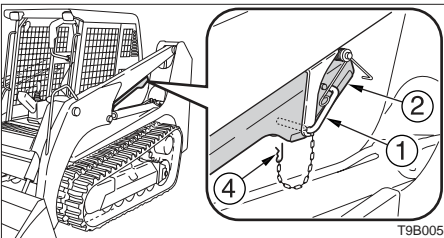

7. Raise the lift arm stop (2) into storage position and insert the locking pin (1) through lift arm stop and bracket.
8. Install the R-pin (4) to the locking pin (1).

Fuel Filler Cap

WARNING

- Do not smoke or permit open flames while fueling or near fueling operations.
- Supply fuel in a well ventilated place and with the engine stopped.
- Clean up spilled fuel immediately.
- Do not fill the fuel tank to capacity. Allow room for expansion.
- Tighten the fuel filler cap securely.

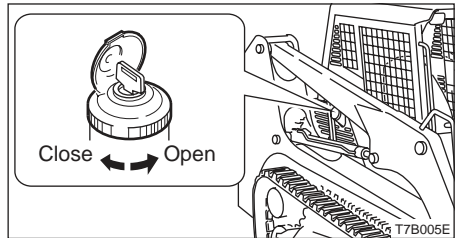

Opening

1. Open the key cover, insert the key and turn it counterclockwise to unlock the fuel cap.
2. Turn the fuel cap counterclockwise and remove it.

Closing

1. Set the fuel cap in place and turn it clockwise.
2. Turn the key clockwise to lock the fuel cap, then remove the key.



Seat

⚠ WARNING

Adjust, secure and latch the operator's seat.

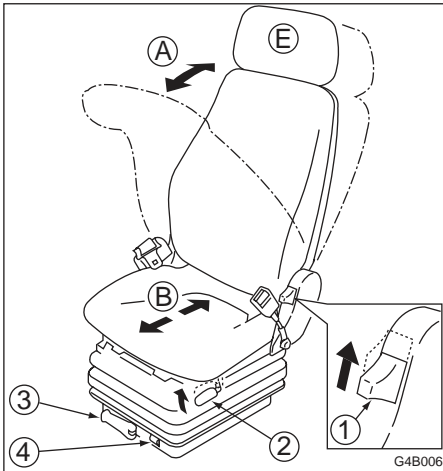

G4B006

(A) Back angle adjustment**⚠ WARNING**

- Do not set the seat back to its maximum reclining position and slide the seat backwards at the same time. Doing so may break the rear window glass, resulting in injury.
- Be careful not to allow the force of the spring to bring the seat back sharply forward.

1. Raising your torso, sitting down firmly in the seat.
2. Pulling lever (1) allows you to use the pressure of the springs in the seat pressing against your back to adjust the reclining angle of the seat back. Release the lever (1) at the desired angle and the seat back will be locked in that position.

(B) Fore-and-aft adjustment

1. Pull on lever (2) and slide the seat backward or forward to bring it to the optimum position for operating the machine.
 2. Release the lever (2) at the desired position and the seat will be locked there.
- Adjustment stroke: 15 steps, 150 mm (5.9 in.)

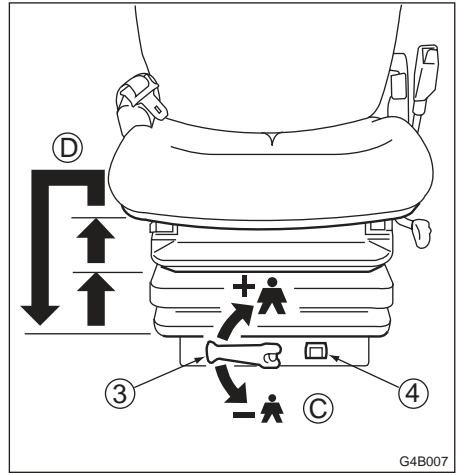

G4B007

(C) Weight adjustment

1. Turn handle (3) until the indicator (4) will show the operator's weight.
May be set to any value from 10 kg steps, 50 to 130 kg (110 to 287 lbs.)

(D) Vertical adjustment

Upward

1. Lift the seat to first or second position click-stop.

Downward

1. First lift the seat to highest position, then the seat can be lowered to lowest position.

(E) Headrest adjustment (Option)

The position of the headrest can be adjusted in the vertical and front/back directions.

1. To adjust in the vertical direction, grasp the headrest with both hands and move it upwards or downwards.
2. To adjust in the front/back direction, grasp the headrest with hands and move it forwards or backwards.

**Seat Belt****⚠ CAUTION**

Always fasten the seat belt securely before starting the engine.

Fastening the seat belt

1. Adjust the seat to the optimum position for operating, raise your torso, and sit back firmly into the seat.
2. Pull the seat belt to the desired length.

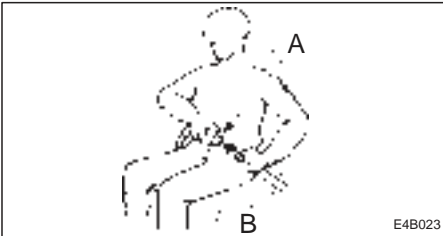

3. Make sure that the belt is not twisted and then insert the tongue plate (A) into the buckle (B) of the seat belt until you hear a clicking sound as it locks in place.

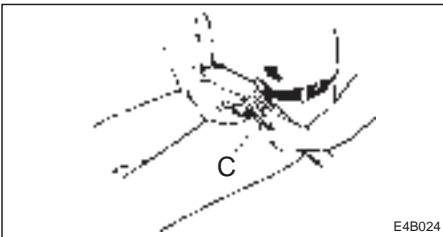
Releasing the seat belt

1. To remove the seat belt, simply press the button (C) located on the buckle. The seat belt is automatically stowed away.

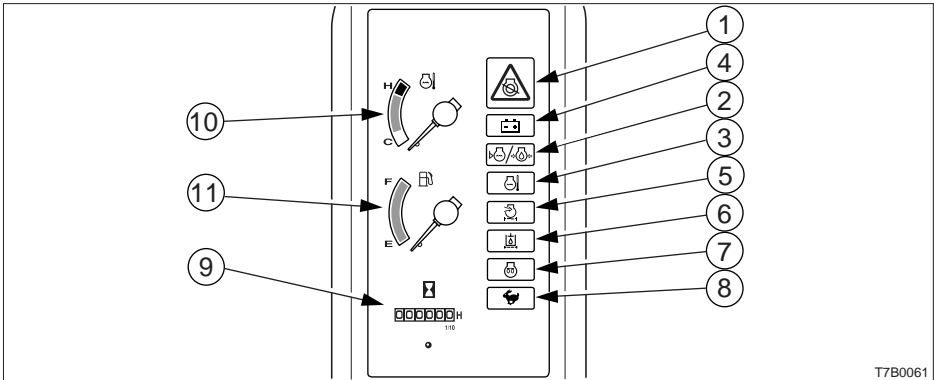

T7B0061

Warning Lamps

IMPORTANT: If a warning lamp flashes and an alarm is sounded, stop all operations immediately and inspect and maintain the appropriate part.

Refer to page 140 "Troubleshooting".

1. Engine Emergency Lamp



T7B007

This lamp flashes and an alarm is sounded if the engine oil pressure or coolant level in the radiator

drops or the coolant temperature rises abnormally while the engine is running. After approximately 5 seconds, the engine stops automatically.

2. Engine Oil Pressure/Coolant Level Warning Lamp



L3B036

This lamp flashes and an alarm is sounded if the lubricant oil pressure or coolant level in the radiator

drops abnormally while the engine is running.

3. Coolant Temperature Warning Lamp



C4B012

This lamp flashes and an alarm is sounded if the engine coolant temperature rises abnormally while the engine is running.

4. Battery Charge Warning Lamp

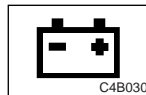

C4B030

This lamp flashes and an alarm is sounded if a problem arises in the charging system while the engine is running.

5. Air Cleaner Warning Lamp



G4B010

This lamp flashes and an alarm is sounded if the air cleaner filter is clogged while the engine is running.

6. Line Filter Warning Lamp



T7B008

This lamp flashes and an alarm is sounded if the hydraulic oil line filter is clogged while the engine is

running. This lamp may flashes directly after the engine in started in cold weather. This is not a malfunction. The lamp will turn off while the engine is warming up.



Indicators

7. Glow Lamp



This lamp turns off when engine preheating is completed.

8. Travel Speed Lamp



This lamp lights when the travel speed switch is set to 2nd (high speed).

Meters

9. Hour Meter

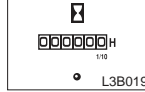

This displays the total engine running time in hours. The rightmost digit indicates tenths of hours (6 minutes).

Set the inspection and maintenance intervals according to the time displayed on the hour meter.

10. Water Temperature Gauge

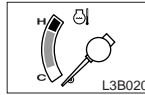

This gauge indicates the temperature of the engine coolant water.

The needle should be within the green range during machine operation. The red range indicates overheating.

11. Fuel Gauge

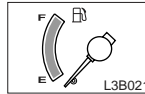

This gauge indicates the amount of fuel in the tank. Be sure to top off the tank before running out of fuel.



Starter Switch

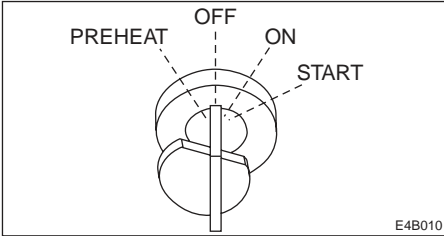

IMPORTANT: Do not repeatedly switch the key from OFF to ON and ON to OFF over a short period. Doing so will cause engine breakdown.

PREHEAT Position for preheating the engine.

OFF Position for stopping the engine and inserting or removing the key.

ON Position in which the engine is running. At this position, all the electrical equipment is functional.

START Position for starting the engine. When the key is released, the switch automatically returns to the ON position.

Horn Switch

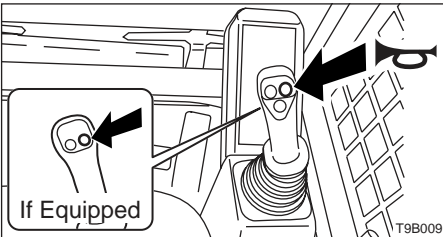

Press the switch on the right control lever to blow the horn.

Float Switch



- Make sure the bucket is lowered to the ground before putting the lift arms in the Float position. Putting the lift arms in the Float position while they are raised will cause the bucket to fall and is extremely dangerous.
- Do not drive the loader forward with the lift arms in the Float position.

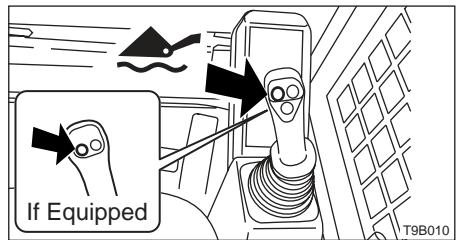

This switch sets the lift arms to the Float position. The lift arms are put to the Float position while this switch is pressed in. When the switch is released, the Float position is canceled.

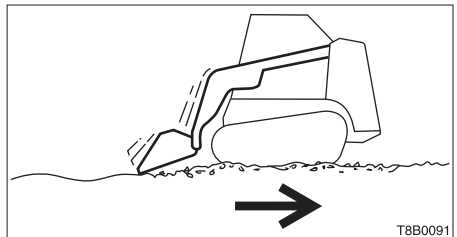

When in the Float position, the bucket can follow the level of the ground without movement of the control lever.



Auxiliary Hydraulic Switches

Auxiliary Hydraulic Buttons (A), (B)

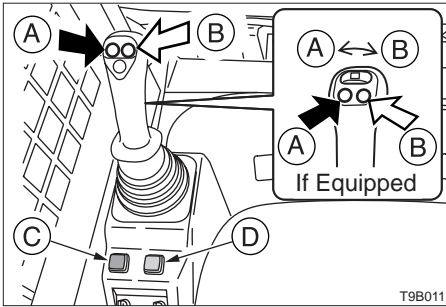

Press those buttons to control the flow of the oil in the auxiliary hydraulic circuit.

- (A) Hydraulic oil flows to auxiliary hydraulic line (a)
- (B) Hydraulic oil flows to auxiliary hydraulic line (b)

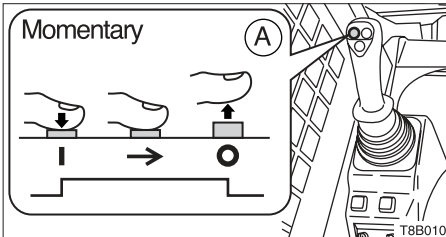

The button turns on when it is pressed, and turns off when it is released.

- When 1-way flow is selected by turning on the flow selector button (C), the auxiliary hydraulic button only functions when side (A) is pressed.

Refer to page 69 "Operating the Auxiliary Hydraulics".

Slider Switch (If equipped) (Proportional control)

Proportional control allows for slow-to-fast movement of auxiliary functions.

Example: If you move the slider switch half way, the auxiliary function will move at approximately one-half speed.

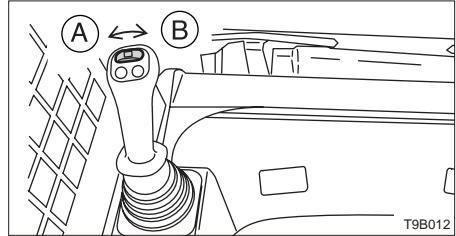

Move this switch to control the flow of the oil in the first auxiliary hydraulic lines.

Flow Selector Switch (C)

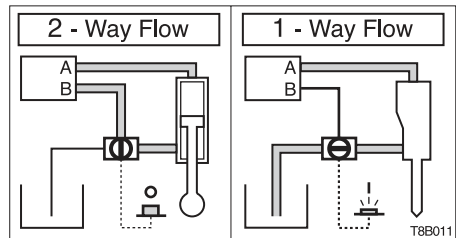
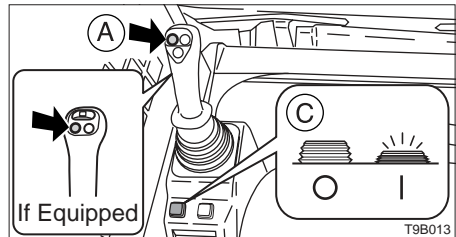

The flow of the auxiliary hydraulic system (lines (a) and (b)) can be set to either 1-way or 2-way flow. When the switch is pressed, the flow switches from 2-way to 1-way and the built-in lamp (green) lights. When pressed again, the flow switches from 1-way back to 2-way and the lamp turns off.

O / OFF .. 2-way flow

I / ON 1-way flow

The oil in line (b) returns to the hydraulic tank.



Detent Mode Switch (D)

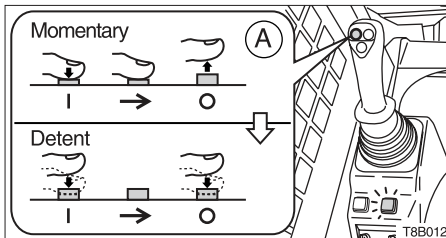
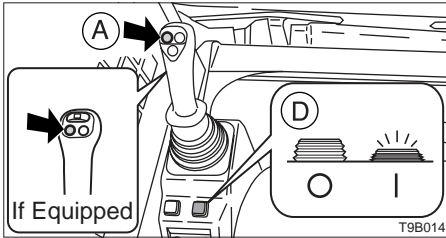

This switches the function of auxiliary hydraulic switch (A). Normally auxiliary hydraulic switch (A) is on while it is pressed and turns off when it is released. If pressed after pressing this switch, auxiliary hydraulic switch (A) turns on and stays on when it is pressed, and only turns off when it is pressed again. The built-in lamp (orange) lights when the switch is on. Thus there is no need to hold the switch in. When this switch is pressed again, the function of the auxiliary hydraulic switch returns to normal and the lamp turns off.

Travel Speed Switch

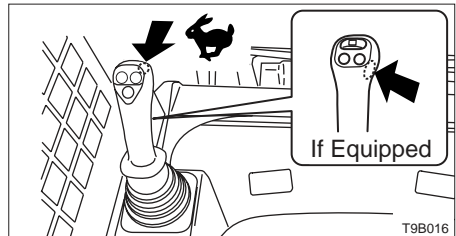

Press this switch to set the travel speed to 2nd speed (high speed) while travel speed lamp lights. Press again to return to 1st speed (low speed) and travel speed lamp turns off. Travel speed is always begin at 1st speed when starting the engine. Refer to page 45 "Travel Speed Lamp".



Light Switches

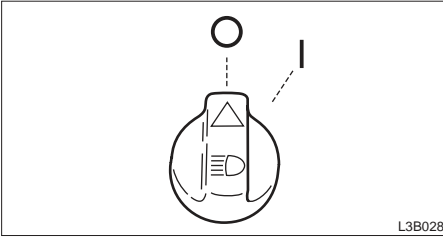

When this switch is turned while the starter switch is at ON, the lights turn on as follows:

Front light switch

○ Off

I Meter light and front lights turn on.

Tail light switch

○ Off

I Tail lights turn on.

Wiper Switches (Option)

IMPORTANT: If no washer fluid is discharged, do not operate the washer. Doing so may damage the pump.

IMPORTANT: Operating the wiper with no moisture on the windshield will scratch the glass. Apply water or washer fluid when operating the wiper.

IMPORTANT: In cold seasons, the wiper blade may freeze to the glass. Operating the wiper forcibly may damage the wiper motor.

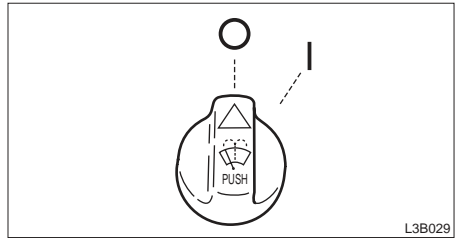

Front wiper switch

○ Off

I Wiper operates.

PUSH Washer fluid is squirted from the nozzle while pressed, and stops when released.

Rear wiper switch

○ Off

I Wiper operates.

PUSH Washer fluid is squirted from the nozzle while pressed, and stops when released.



Safety Bar

WARNING

- Before leaving the operator's seat, raise the safety bar to engage the lock and stop the engine.
If any controls should be touched accidentally when the safety bar is lowered, the machine will move suddenly, and cause serious injury or death.
- Be careful not to touch the control levers and pedal when lowering or raising the safety bar.

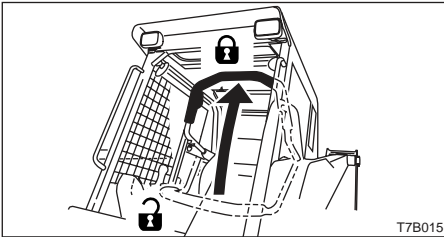

This device is for locking the control levers, pedal and selector, detent mode and high flow switches.

When the safety bar is lifted, then levers, pedal and switches are locked.

Throttle Lever

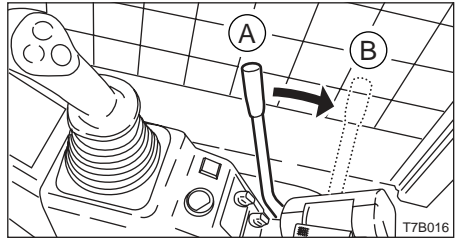

This controls the engine speed.

- (A) Low idling
- (B) Maximum speed

Right Control Lever

WARNING

Be careful to check which pattern of lever control arrangement you are operating with before beginning operations.

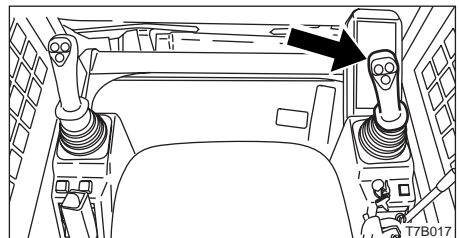

Use this lever to operate the lift arms and bucket.

Refer to page 62 "Lever Pattern".

Refer to page 68 "Operating the Right Control Lever".



Left Control Lever

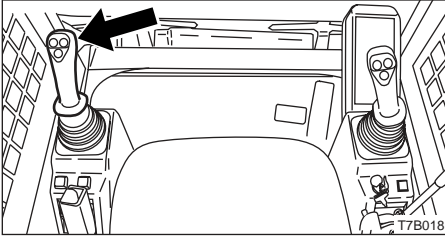

Use this lever to move forward and backward and to change directions.

Refer to page 62 “Lever Pattern”.

Refer to page 65 “Operating the Left Control Lever”.

Auxiliary Pedal (If equipped)

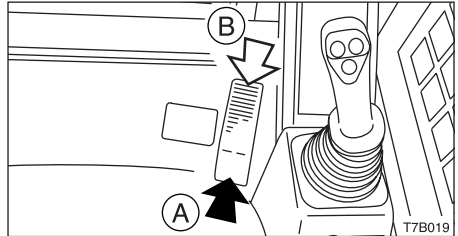

Use this pedal to operate the auxiliary hydraulics circuit.

- (A) Hydraulic oil flows to auxiliary hydraulic line (a)
- (B) Hydraulic oil flows to auxiliary hydraulic line (b)

Refer to page 69 “Operating the Auxiliary Hydraulics”.



Heater (Option)

WARNING

- Always be sure to allow sufficient ventilation.
- Do not place combustible or explosive objects near the air outlets.

Fan Switch

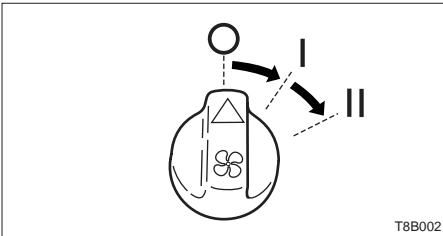

- O Off
I Heater fan rotates at low speed.
II Heater fan rotates at high speed.

Supplement: Use the heater with care in warm seasons. Coolant circulates in the heater even when the heater switch is turned off.

When the heater is no longer needed, stop coolant circulation as follows:

IMPORTANT: Use the valve (1) either fully open or fully closed. Cooling water could leak when the valve is set at a halfway position.

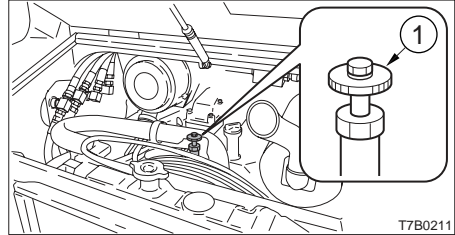

1. Park on a flat surface and stop the engine.
2. Open the engine hood.
3. Turn the valve (1) clockwise until it stops to close it.



Auxiliary Hydraulic Lines

WARNING

- Oil may spurt out if caps or filters are removed or pipes disconnected before releasing the pressure in the hydraulic system.
 - When removing plugs or disconnecting hoses, release the internal pressure before removing.
- Hydraulic fluid, tubes, fittings and quick couplers can get hot when running machine and attachments. Be careful when connecting and disconnecting quick couplers.

These lines deliver the hydraulic oil necessary for operating the other attachments.

- Auxiliary hydraulic flow rate and rated pressure:
 - Flow Rate ... CTL60: 68L/min (18.0 gal/min)
 - CTL70: 75L/min (19.8 gal/min)
 - CTL80: 88L/min (23.2 gal/min)
 - Rated Pressure 20.6 Mpa (2987 psi)

Quick Couplers

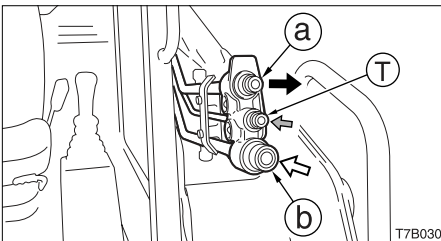

Connecting: Remove dirt or debris from the surface of both the male and female couplers, and from the outside diameter of the male coupler. Visually check the couplers for corroding, cracking, damage or excessive wear. If any of these conditions exist, the coupler(s) must be replaced.

Install the male coupler into the female coupler. Full connection is made when the ball release sleeve slides forward on the female coupler.

Disconnecting: Hold the male coupler. Retract the sleeve on the female coupler until the couplers disconnect.

Releasing the Residual Pressure

Connecting: Push the quick couplers tightly together and hold for five seconds; the pressure is automatically released as the couplers are installed.

Disconnecting: Push the quick couplers tightly together and hold for five seconds; then retract the sleeve until the couplers disconnect.

Connecting the Hydraulic Circuits

To connect the attachment hydraulic lines, use the following procedures:

1. Connect the attachment hydraulic lines to ports (a) and (b).
 - When fitted with a hydraulic breaker:
 - a. Connect the return circuit to port (b) and the supply circuit to port (a).
 - b. Turn on the flow selector switch. Refer to page 47 "Flow Selector Switch". Some attachments may have a case drain, which needs to be connected to the small port (T).
2. When connecting is complete, purge air from the hydraulic lines.
 - a. Start and run the engine at low idle with no load for 10 minutes.
 - b. With the engine running at low idle, operate the auxiliary hydraulics switch repeatedly (approx. 10 times) to purge air from the hydraulic lines.
 - c. Stop the engine and wait for more than 5 minutes until bubbles escape from the hydraulic oil in the tank.



IMPORTANT: Follow the procedures for purging air as instructed by the attachment manufacturer if specified to do so.

3. Check for leaks.

High Flow Hydraulic System (If Equipped)

The High Flow function provides additional flow to the system to operate an attachment that requires more hydraulic flow (EXAMPLE: Lawn mower).

This system can be used only for one-way flow attachments.

- Auxiliary hydraulic flow rate and rated pressure:
Flow Rate ... CTL80: 150L/min (39.6 gal/min)
Rated Pressure 20.6 Mpa (2987 psi)

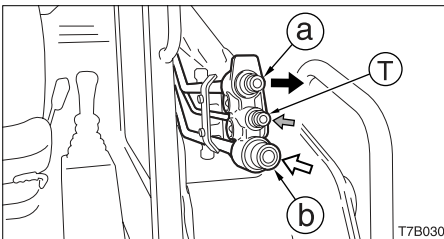

1. Connect the attachment hydraulic lines to ports (a) and (b).

Refer to page 53 “Connecting the Hydraulic Circuits”.

Some attachments may have a case drain, which needs to be connected to the small port (T).

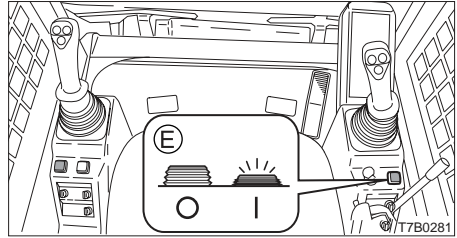

2. Turn on the High Flow switch (E) (green light is ON).

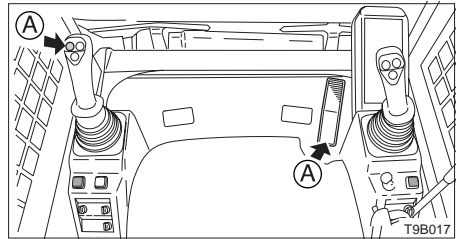

3. Press the auxiliary hydraulic switch (A) or press the heel side (A) of the pedal.



External Power Socket (Option)

WARNING

Only use applicable electric products with this socket.

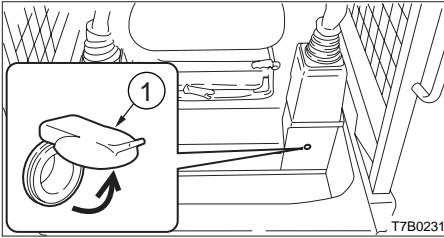

Use this socket as an external power supply. When using this socket, be careful not to exceed 12V/5A.

To use, raise the cap (1).

Interior Light (Option)

IMPORTANT: The battery capacity will decrease if the interior light is left on for long periods of time the engine stopped. Turn the lamp off when leaving the machine.

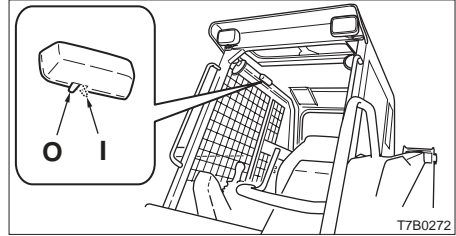

O Off

I Lit



OPERATION

Before Starting Operation	58
Starting and Stopping the Engine	59
Machine Operation	62
Operating Procedures	70
Parking the Machine	78
Handling in Cold Weather	79
Handling Rubber Crawlers	80



Mounting and Dismounting

WARNING

- Do not jump on or off the machine. Never attempt to mount or dismount a moving machine.
- When mounting and dismounting the cab, first open the door fully to the locked position and check that it does not move. (For machines with front door)

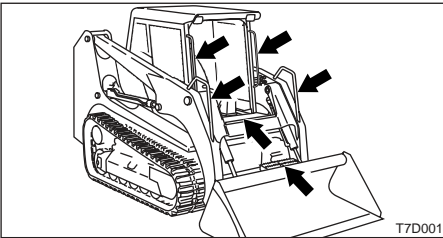

- Always face the access system and maintain a three point contact with the recommended handrails and steps while getting on and off the machine. Keep steps and platform clean.
- Never use the control levers as hand holds.

Walk-Around Inspection

Perform the walk-around inspections before starting the engine the first time that day. Perform the inspections as described under “Maintenance - Walk-Around Inspection” (pages 100 and 101).

Daily Inspection

Perform the daily inspections once a day before starting the engine the first time that day. Perform the inspections as described under “Maintenance - Daily Inspection” (pages 102 to 106).

**Before Starting the Engine**

1. Adjust the seat for a comfortable operating position.
2. Fasten the seat belt.

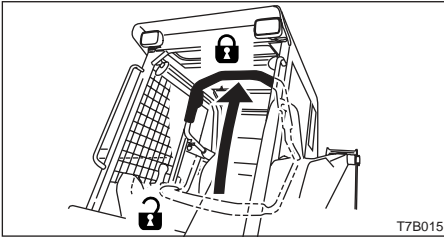

3. Check that the safety bar is in the locked position.

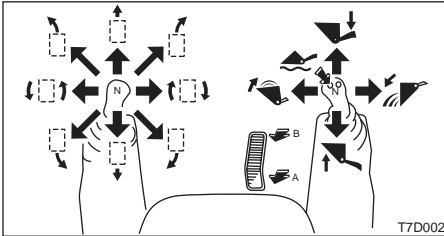

4. Check that the control levers and pedals are in the neutral position.

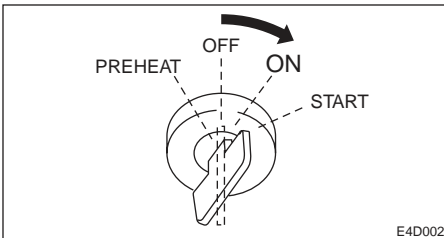

5. Insert the key into the starter switch, turn it to the ON position, then perform the following inspection:

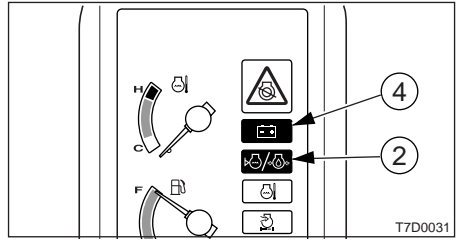

- All the warning lamps flash and an alarm is sounded for 2 seconds. The meters also start functioning. After 2 seconds, only the battery charge warning lamp (4) and engine oil pressure/coolant level warning lamp (2) flash, and the other lamps turn off.
- Turn the light switch to check that the front light, tail lights and meter light turn on.
- Check the fuel level.

If a lamp does not light or the alarm is not sounded, the bulb may be burnt out or a wire may be damaged. Contact a Gehl sales or service outlet for repairs.

**Starting the Engine****⚠ WARNING**

- Clear the area of all persons.
- Sound horn to alert everyone around the machine.

IMPORTANT: Do not run the starter motor for more than 15 consecutive seconds. If the engine fails to start, wait for 30 seconds to protect the battery, and then try again to start the engine.

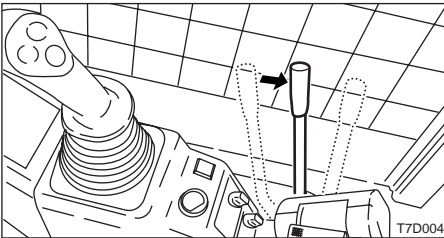
Normal Starting

1. Pull the throttle lever to the middle position.

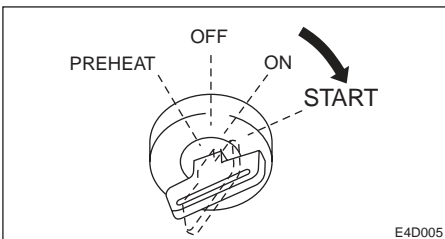

2. Turn the key to the START position and start the engine.
3. Once the engine starts, release the key. The key automatically returns to the ON position.
4. Check that the warning lamps are off.
5. Return the throttle lever and warm up the engine.
Refer to page 61 "Warming Up the Engine".

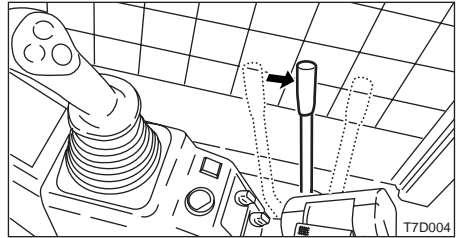
Starting in Cold Weather

1. Pull the throttle lever to the middle speed position.

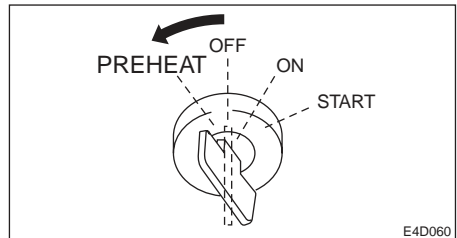

2. Turn the key to the PREHEAT position and hold it there while the glow lamp is lit (about 15 seconds).
3. After the glow lamp turns off, then turn it to the START position and start the engine.
4. Once the engine starts, release the key. The key automatically returns to the ON position.
5. Check that the warning lamps are off.
6. Return the throttle lever and warm up the engine.
Refer to page 61 "Warming Up the Engine".



Warming Up the Engine

IMPORTANT: Avoid racing the engine until it is warmed up.

Do not warm up the engine for long periods of time (20 minutes or more).

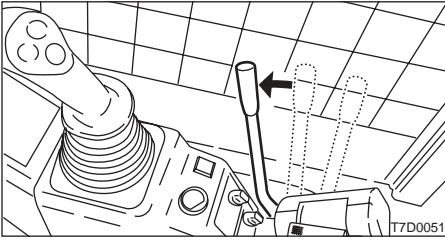

1. Return the throttle lever, then idle the engine and run it for about 5 minutes with no load.

Stopping the Engine

IMPORTANT: Do not stop the engine suddenly when operating with heavy loads or at maximum speed. Doing so may cause the engine to overheat or seize. Never bring the engine to a sudden stop except in the case of a true emergency.

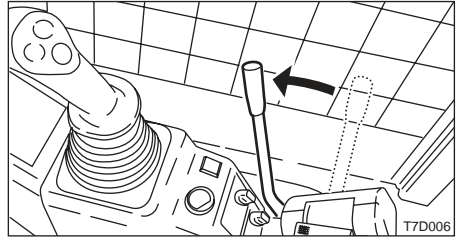

1. Idle the engine for about 5 minutes to gradually let it cool.

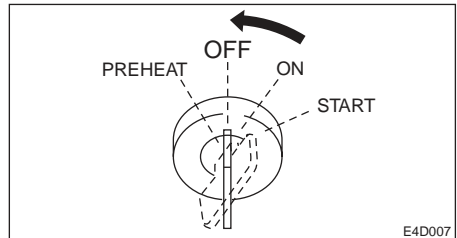

2. Turn the key to the OFF position to stop the engine.



Lever Pattern

! WARNING

- Be careful to check which pattern of lever control arrangement you are operating with before beginning operations.
- The explanations in this manual are for this pattern.

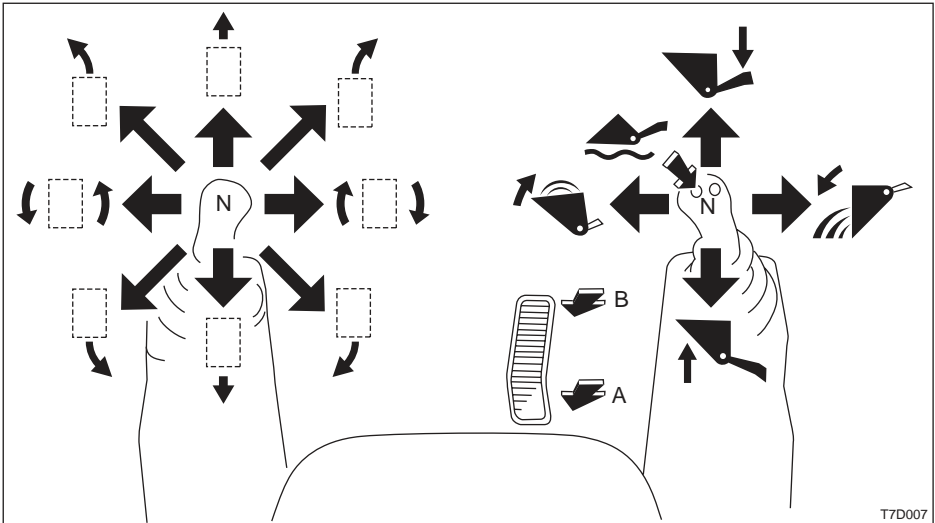

T7D007

	Crawler Forward		Lift Arm Lower
	Crawler Reverse		Lift Arm Raise
	Left Spin Turn		Bucket Rollback
	Right Spin Turn		Bucket Dump
	Left Pivot Turn		Lift Arm Float
	Right Pivot Turn		Hydraulic oil discharged from auxiliary port (b)
	Right Pivot Turn Reverse		Hydraulic oil discharged from auxiliary port (a)
	Left Pivot Turn Reverse	N	Neutral



Warming Up the Hydraulics

WARNING

Operating the working equipment without warming up the hydraulics is dangerous, as response will be slow and the equipment may move in unexpected ways. Be sure to sufficiently warm up the hydraulics.

IMPORTANT: Do not operate the levers suddenly when the hydraulic oil temperature is below 20°C (68°F). The proper hydraulic oil temperature during operation is 50 to 80°C (122 to 176°F), but if operations must be performed at lower temperatures, heat up the hydraulic oil to at least 20°C (68°F).

Normal Warm-up

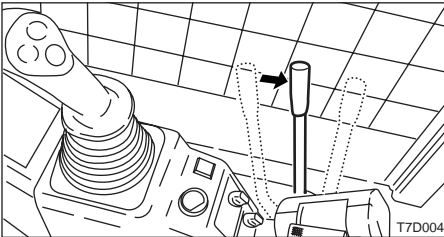

1. Run the engine at medium speed for about 5 minutes with no load.

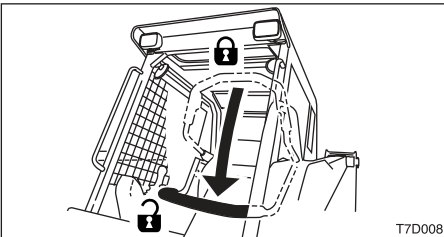

2. Set the safety bar to the released position and lift the bucket from the ground.

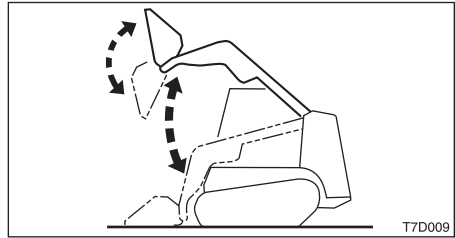

3. Extend and retract each of the cylinders several times with no load.

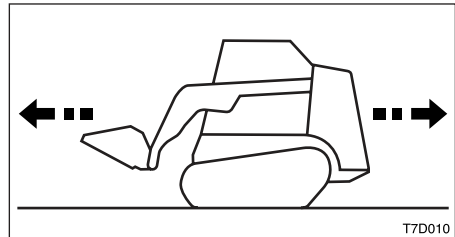

4. Travel slowly forward and backward several times.

Warming Up in Cold Weather

1. Perform the normal warm-up procedure.

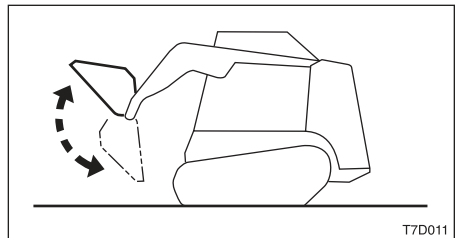

2. Set the bucket cylinder at the stroke end and keep it there.
Do not do this for more than 30 seconds.
3. Repeat step 2 until the bucket operating speed is normal.



Inspection After Warm-up

After warming up the engine and hydraulic oil, perform the checks and inspections described below, and repair if there is a problem.

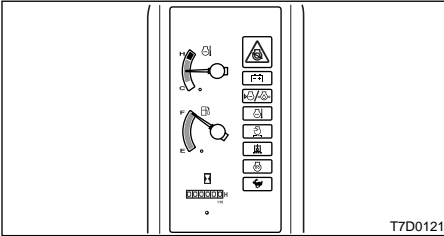

1. Check that the warning lamps and meters are as follows:
 - Are all the warning lamps off?
 - Is the water temperature gauge's needle within the green range?
2. Check that there are no irregularities in the exhaust color, sound and vibrations.

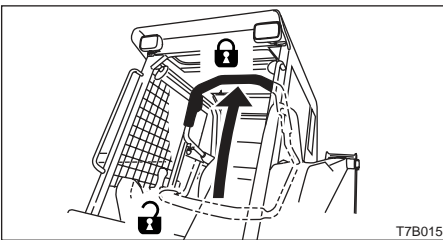

3. Set the safety bar to the locked position and check that the control levers, auxiliary pedal are locked.

**Operating the Left Control Lever****⚠ WARNING**

- Never allow anyone to enter the turning radius and machine path.
- Signal your intention to move by sounding the horn.
- Traveling and turning should be performed with the bucket cylinder fully retracted and the bucket at a height of approximately 30 cm (12 in.) from the ground.
- Avoid sudden stops, start or turns.
- Do not raise the safety bar while traveling. This is dangerous, since raising the safety bar will cause the parking brake of the traveling motor to operate and apply the brake abruptly.
- Do not switch off the starter switch while traveling. Doing so will cause sudden braking and is dangerous.
- Before backing up, visually check for safety to the rear. Backing up without checking could result in contact with a worker or obstacle.
- If unavoidable while traveling, when operating the working equipment, do so with care.
- Avoid crossing over obstacles whenever possible. If you must do so, keep the bucket close to the ground and travel slowly. Never cross obstacles if they will seriously tilt the machine (to an angle of 15° or greater).
- When traveling on rough terrain or when carrying a load, lower the load and travel slowly.
- Remove any obstacles in the machine's path.

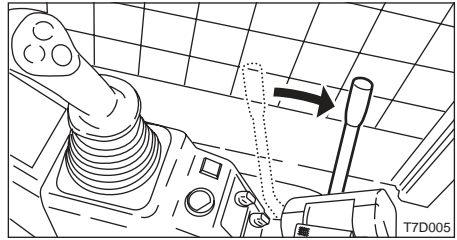

1. Increase the engine speed.

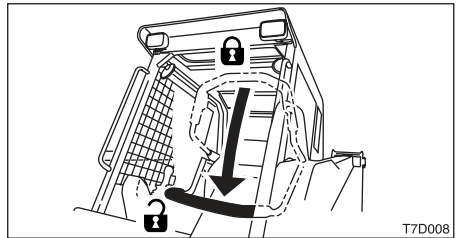

2. Set the safety bar to the released position.

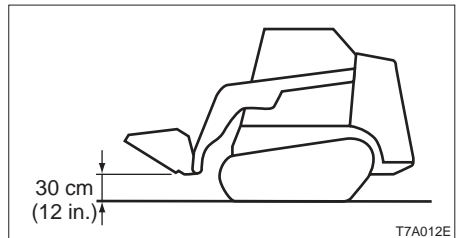

3. Rollback the bucket fully and lift the bucket to 30 cm (12 in.) above the ground.

Use the left control lever to operate the crawler belts.

Return the left control lever to the neutral position to stop the crawler belts.



Forward and Reverse Travel

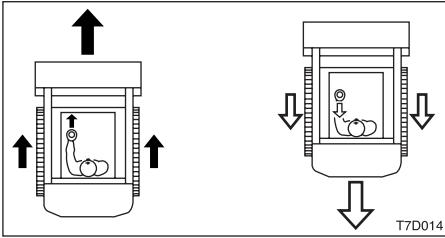

- ➔ To move forward:
Push the left control lever forward.
- ⇨ To move backward:
Pull the left control lever backward.

Traveling in 2nd (High) Speed

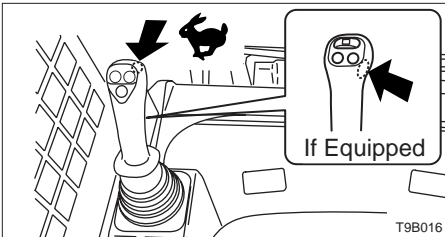

Press the travel speed switch on the left control lever to switch to 2nd (high) speed, and press it again to return to 1st speed (low speed).

Pivot Turn

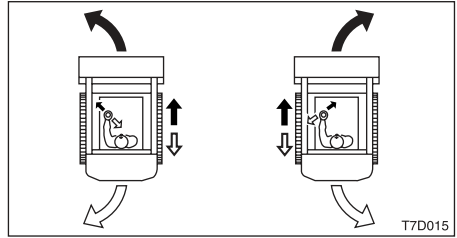

- Turning to the left:
- ➔ To turn forward to the left:
Tilt the left control lever forward to the left.
 - ⇨ To turn backward to the left:
Tilt the left control lever backward to the right.
- To turn to the right, operate the left control lever in the opposite way.

Spin Turn

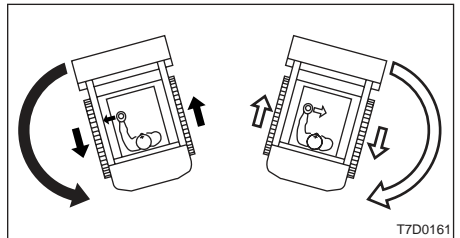

- ➔ To spin left:
Tilt the left control lever to the left.
- ⇨ To spin right:
Tilt the left control lever to the right.

**Stopping Travel****⚠ WARNING**

- Park the machine on firm, level ground and apply the parking device. If you must park on a slope or incline, block the machine securely to prevent movement.
- If any controls should be touched accidentally when the safety bar is lowered, the machine will move suddenly, and cause serious injury or death.

⚠ CAUTION

Never bring the machine to a sudden stop except in the case of a true emergency. Stop as gently as possible.

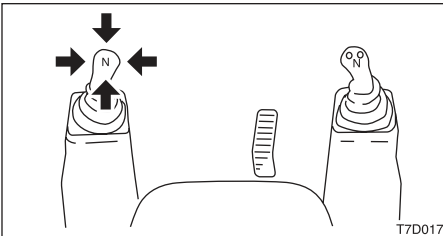

1. Slowly set the left control lever to the neutral position. The machine stops. Braking is automatically applied by the hydrostatic drive system when the left control lever is returned to the neutral position. Full braking is achieved when the safety bar is raised.



Operating the Right Control Lever

⚠ WARNING

- Be careful to check which pattern of lever control arrangement you are operating with before beginning operations.
- Make sure the bucket is lowered on the ground before floating the lift arms. Floating the lift arms while they are raised will cause the bucket to fall and is extremely dangerous.
- Do not drive the loader forward with the lift arms in Float position.
- At times of combined operation of bucket and arm lowering, continuation of the combined operation after the bucket has reached the stroke end will result in the arm rising or stopping without going lower. Be cautious of any unexpected movement of the arm.

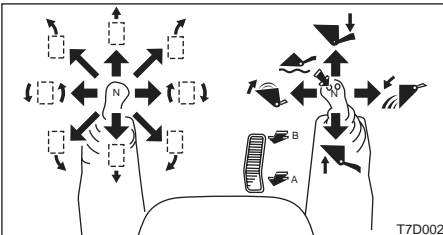

Use the right control lever to operate the lift arms and bucket.

Return the right control lever to the neutral position to stop the lift arms and bucket.

1. Set the safety bar to the released position.

Operating the Lift Arms

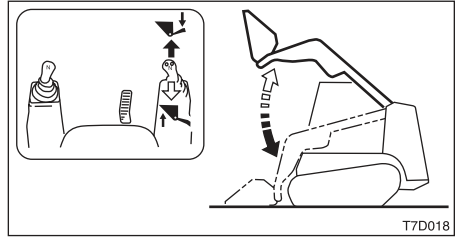

- ➔ To lower the lift arms:
Push the right control lever forward.
- ⇨ To raise the lift arms:
Pull the right control lever backward.

Operating the Bucket

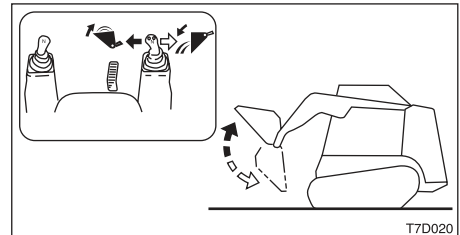

- ➔ To rollback:
Tilt the right control lever to the left.
- ⇨ To dump:
Tilt the right control lever to the right.

Operating the Lift Arms Float

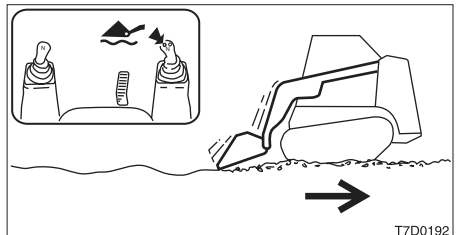

- ➔ To floating the lift arms:
Press the float switch on the right control lever.



Operating the Auxiliary Hydraulics

Use this to operate a breaker, angle bucket or other attachment.

Two methods of operation are permitted: operation with the auxiliary hydraulic switches and operation with the auxiliary pedal.

Operating the Auxiliary Hydraulic Switches / the Auxiliary Pedal

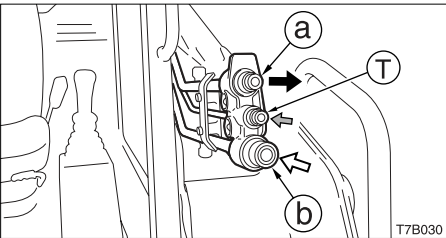
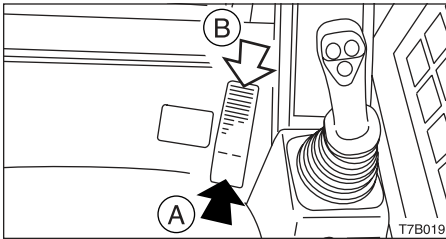
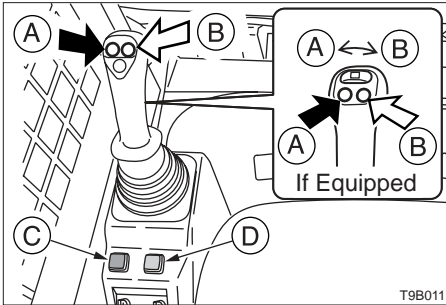

- ➔ To deliver hydraulic oil to port (a):
Depress (A).
- When using a hydraulic breaker or other 1-way flow attachment.
- ⇨ To deliver hydraulic oil to port (b):
Depress (B).

When using a hydraulic breaker or other 1-way flow attachment

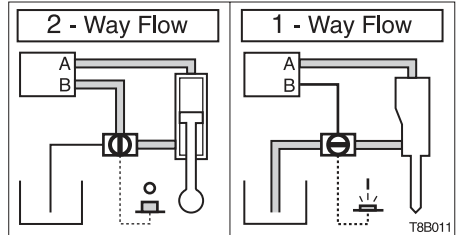

Change the direction of the hydraulic oil flow by setting Flow selector switch (C) ON to return the oil in the (b) port line directly to the hydraulic tank.

Refer to page 47 "Flow Selector Switch".

When using a detent mode switch (D).

IMPORTANT: Please note that operation over long periods with Detent mode switch pressed will cause the hydraulic oil temperature to rise and will shorten the life of the hydraulic units.

A press of Detent mode switch (D) lights the orange lamp and the auxiliary hydraulic switch (A) changes to detent mode.

Detent mode

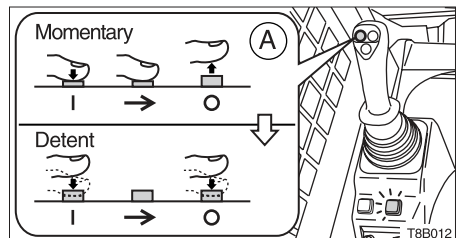

One press of the auxiliary hydraulic switch (A) sets it to ON and one more press sets it to OFF. There is no need to continue pressing the switch.

Refer to page 48 "Detent Mode Switch".



Prohibited Operations

WARNING

- Do not operate on base rock (hard or soft).
- If you must operate the lift arms and bucket while traveling, operate at speeds slow enough so you have complete control at all times.

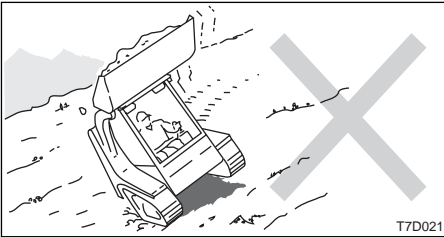

- Work should not be performed on a slope since the balance of the machine can be lost when operating the working equipment and there is the danger of the machine tipping over.

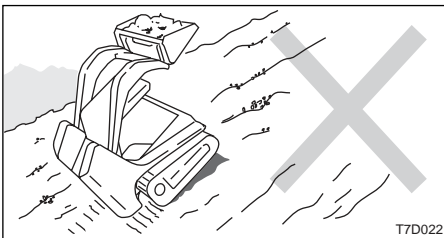

- Keep the bucket as low as possible during travel. Do not travel or attempt to change directions with the bucket raised.

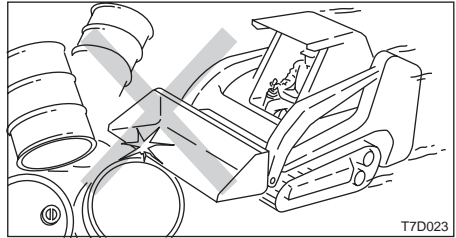

- Travel at a speed which is appropriate for the conditions. Travel at low speed when the field of view is obstructed and take extra precautions with hazardous materials.

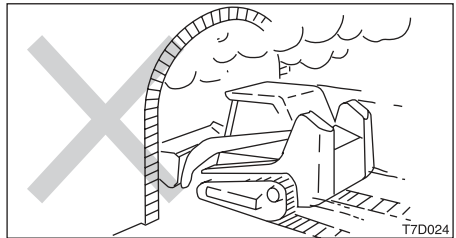

- Do not use this loader in areas where there is danger of explosion from volatile gases. Also avoid using the loader where the exhaust gases could come in contact with flammable items.

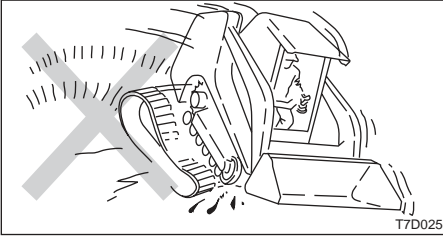

- Do not attempt a spin turn or pivot turn at high speeds.
Never do this since it may cause the crawler to fall off, extreme wear, etc.

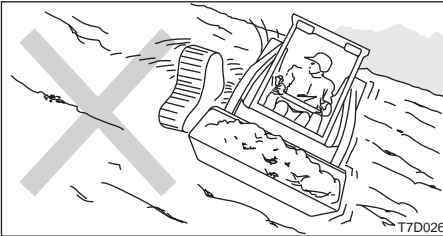

- Do not cut across a slope.
Never do this since it may cause the crawler to fall off, extreme wear, etc.

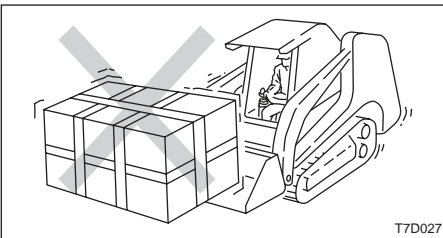

- Do not exceed the loader's rated operation capacity.
- Do not use buckets or attachments which exceed the loader's operation capacity.

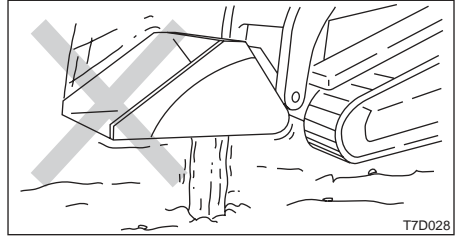

- Do not use the downward force of the bucket to drive piles.

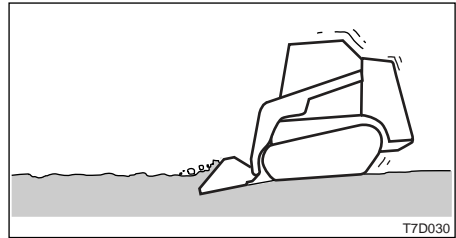

- Do not dig down deeply with the bucket.
Doing so could damage the bucket and lift arms.

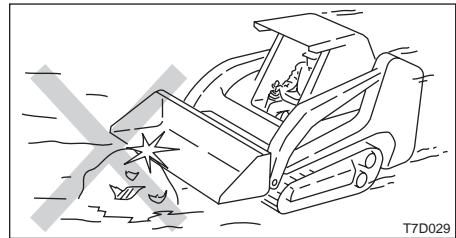

- Hitting the bucket against rocks, etc., could damage the bucket or the bucket cylinder.

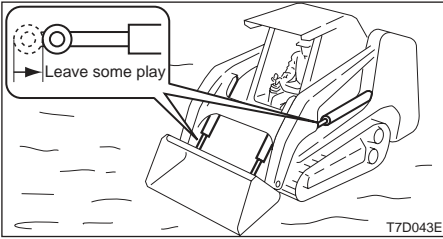

- Do not conduct operations with the cylinders fully extended or retracted. Doing so applies excessive force on the cylinders and may damage them.

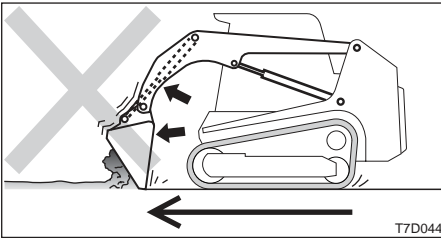

- Do not perform scooping or grading operations with the bucket cylinders fully extended. The traction force will apply extremely heavy loads on the bucket cylinders and this may damage them.

Cautions on Operating

Cautions on Traveling

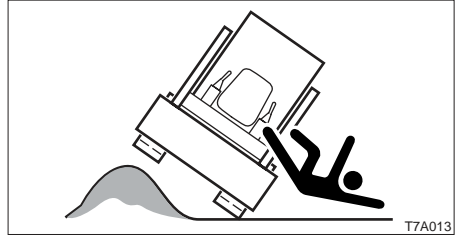

Traveling over obstacles (rocks, stumps, etc.) may subject the body to strong shocks and result in damage. Avoid traveling over obstacles whenever possible. If you must do so, keep the bucket near the ground, travel at low speed, and go over the obstacle at the center of the crawler.

Cautions on Traveling in 2nd (High) Speed

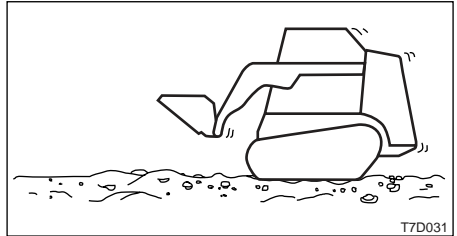

On uneven ground, travel at low speed and avoid accelerating, stopping or changing directions abruptly.

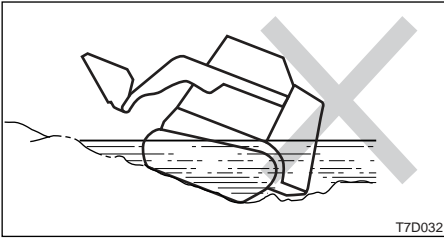
**Cautions on Use in Water**

If you leave water at a sharp angle, the rear of the machine may be submerged, exposing the radiator fan to water and damaging them. Do not let the rear of the machine get submerged.

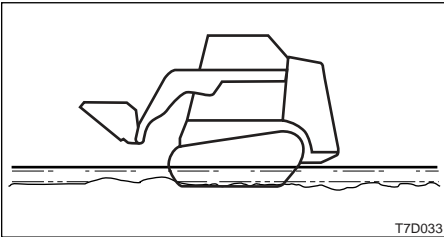

- Allowable water depth
In water, only use the machine up to a depth at which the water comes up to the bottom of the body.
- When greasing places used under water for long periods of time, apply enough grease so that the old grease is expelled.
- Never submerge the main body in water or sand. If the main body should get submerged, contact a Gehl sales or service outlet for inspection.



Cautions on Traveling on Slopes

WARNING

- Never exceed the machine's stability capabilities (maximum gradeability - 30°, lateral tipping angle - 15°). Also note that when actual working area conditions are poor the machine's stability capabilities may be lower.
- When traveling on slopes or grades, lower the bucket to a height of 20 to 30 cm (8 to 12 in.) off the ground. In emergencies, lower the bucket to the ground and stop the machine.
- Travel at slow speed on slopes. Especially when going down slopes, reduce the engine (r.p.m.) speed and set the stroke of the left control lever to half or less before going down. Going down a slope too fast will lead to loss of control.
- When going up or down slopes having a gradient of 15 degrees or more, travel up and down slope with the heavy end of the machine pointed uphill.
- When traveling on a slope, be cautious of tipping over or sliding sideways.
- Do not travel down slopes in reverse.

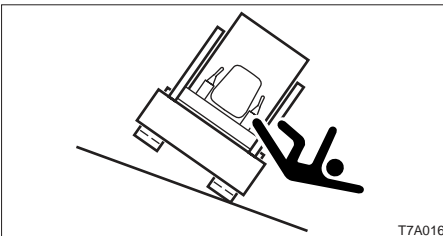

- Do not change directions or cross slopes sideways. First return to a flat surface then redirect the machine.

- On grass, dead leaves, wet metal or frozen surfaces, the machine may slide sideways even on very gentle slopes. Make sure the machine never faces sideways with respect to the slope.

Position on traveling on slopes

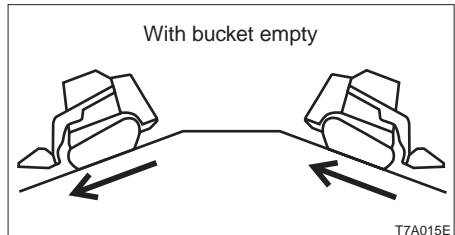
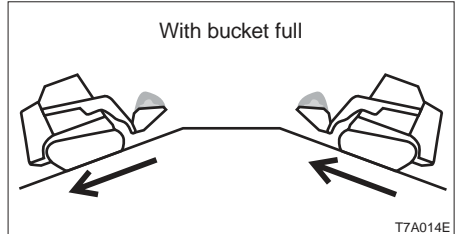



Braking when traveling down slopes

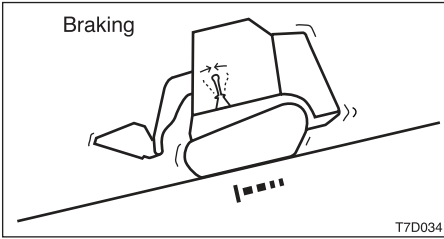

Braking is automatically applied by the hydrostatic drive system when the left control lever is returned to the neutral position. Full braking is achieved when the safety bar is raised.

If the engine stops

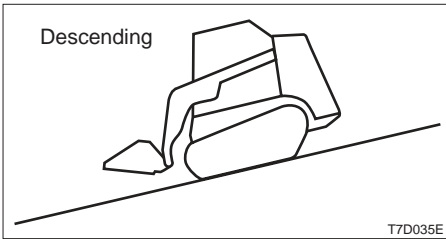

If the engine stops when traveling down a slope, set the control levers and pedal to the neutral position, stop the machine and re-start the engine.

Do not open the front door (if equipped) while traveling on slopes

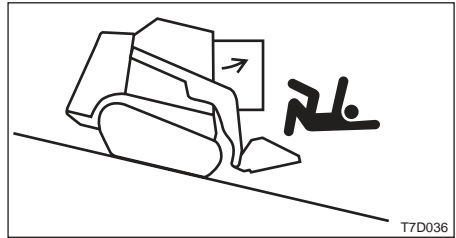

Opening the front door while traveling on slopes can be hazardous, because the force required to open and close the door changes abruptly. Always keep the door closed when traveling on slopes.



Operations Possible with this Machine

IMPORTANT: Do not perform scooping or grading operations with the bucket cylinders fully extended. The traction force will apply extremely heavy loads on the bucket cylinders and this may damage them.

Scooping

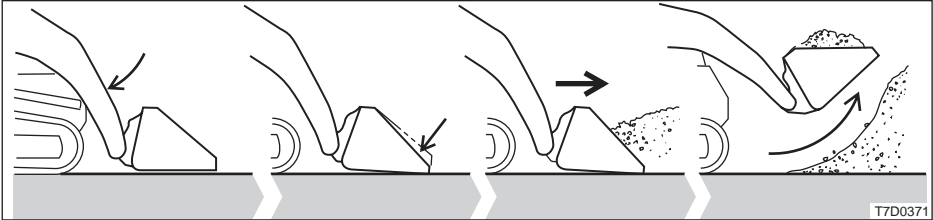

Lower the lift arms and bring the bucket down to the ground with the front end tilted slightly forward, then drive the loader forward until the bucket is filled with the material. Next tilt the bucket backward and scoop up the material.

Grading

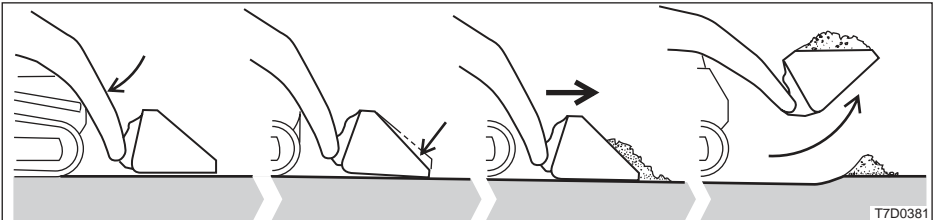

Tilt the front edge of the bucket down at an angle which is appropriate for the ground hardness, then drive the loader forward slowly, digging into the ground with the cutting edge of the bucket. When the bucket is full, tilt it backward.

Leveling

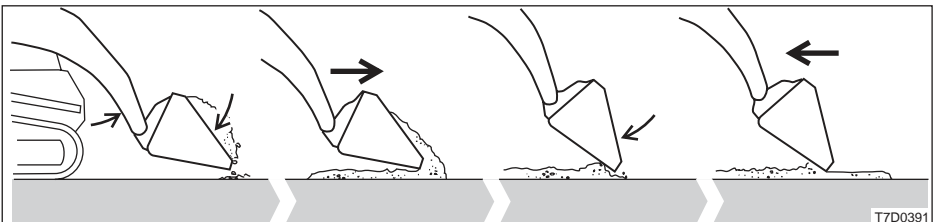

Raise the lift arms and tilt the bucket forward, then release it as the loader is driven forward. Next tilt the bucket forward and lower the front edge until it is slightly above the ground surface, then back the loader over the load which was just released.



Backfilling

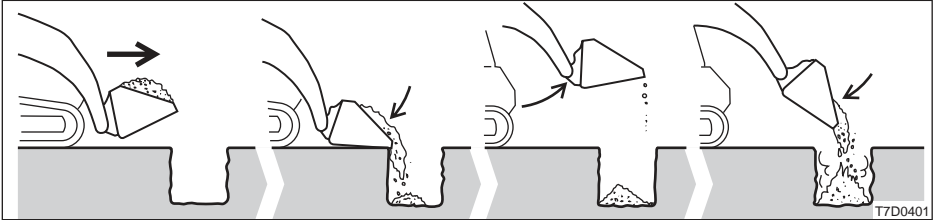

With the bucket lowered, drive near the hole and tilt the front edge of the bucket downward as soon as it passes over the near side of the hole. Raise the bucket and empty the load only when necessary.

Leveling Operation using the Float position

WARNING

- Make sure the bucket is lowered on the ground before floating the lift arms. Floating the lift arms while they are raised will cause the bucket to fall and is extremely dangerous.
- Do not drive the loader forward with the lift arms in Float position.

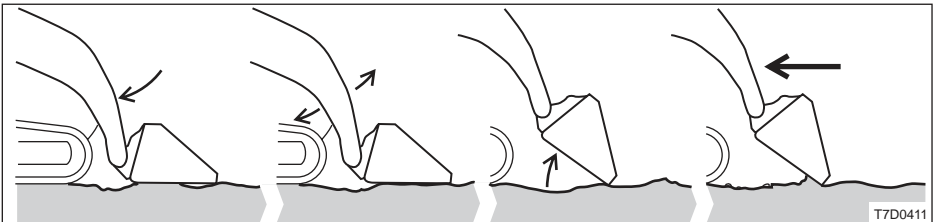

Lower the bucket onto the ground, then put the lift arms in a Float position. Tilt the bucket forward to stand it on its cutting edge, then level the loose material while driving backward.

Loading

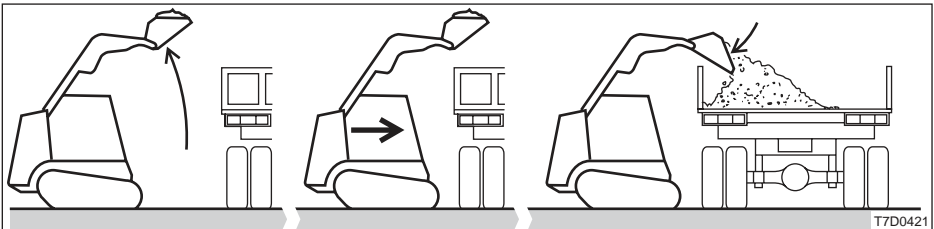

Approach the truck and stop, then raise the bucket until its lower edge clears the truck bed. Drive the loader slowly forward, stop at the position where the bucket is to be tilted forward, then tilt the bucket forward, releasing the material in the bucket into the truck bed. When the truck is half loaded, use the bucket to spread the load evenly.

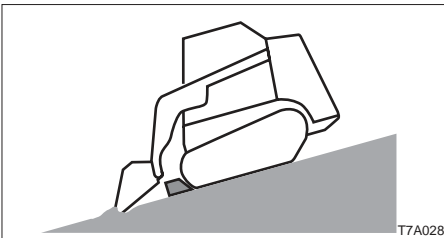
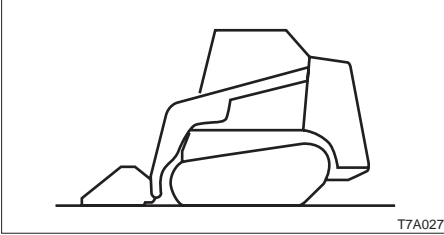
**Parking****⚠ WARNING**

- Park the machine on firm, level ground and apply the parking device. If you must park on a slope or incline, block the machine securely to prevent movement.
- When parking on streets, use barriers, caution signs, lights, etc., so that the machine can easily be seen even at night to avoid collision with other vehicles.
- Before leaving the operator's seat, set the safety bar to the lock position and stop the engine.
- Never leave the machine with the engine running or the lift arms raised, unattended. If arms are left in raised position, they **MUST** be restrained by the lift arm stop.

Before leaving the machine, do the following:

1. Set the control levers and pedal to the neutral position.
2. Return the throttle lever and idle the engine at low speed.
3. Lower the bucket to the ground.
4. Set the safety bar to the lock position.
5. Stop the engine and remove the key.
Refer to page 61 "Stopping the Engine".

Inspection and Checks After Stopping the Engine

1. Check for oil and water leakage and inspect the working equipment, covers and lower body. If any irregularities are found, repair.
2. Fill the fuel tank.
Refer to page 101 "Inspecting the Fuel Level".
3. Remove any paper scraps or dirt from the engine room.
4. Remove any mud from the lower body.

Locking

Be sure to lock the following places:

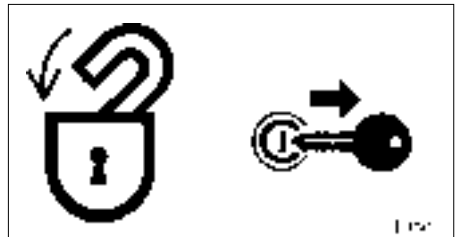

- Fuel filler cap
- Engine hood
- Manual storage
- Cab door



Preparing for Cold Weather

In cold weather, it may be difficult to start the engine and the coolant may freeze. Make the preparations described below.

Changing the Fuel and Lubricant

Change the fuel, hydraulic oil and engine oil to types suited for cold conditions.

Refer to page 90 "Fuel and Lubricant Chart".

Engine Coolant

WARNING

The coolant is combustible. Keep flames away.

Use long-life coolant (antifreeze) and tap water for the engine coolant.

Supplement: New machines are delivered with JIS Type 2 long-life coolant (antifreeze) at a concentration of 50%.

Refer to page 90 "Fuel and Lubricant Chart".

Battery

As the temperature drops, the battery performance decreases.

Inspect the battery. If the charge is low, contact a Gehl sales or service outlet to have the battery charged.

Refer to page 109 "Inspecting the Battery Fluid Level and Replenishing".

Cautions after Completing Operations

Heed the following in order to prevent dirt, water, or other objects stuck on the machine as well as the lower body from freezing:

- Remove any dirt or water from the body.
In particular, water droplets on the hydraulic cylinder rod surfaces could freeze, and if dirt enters into the seals along with this, the seals could break.
- Park the machine on a dry, hard surface. If no appropriate place can be found, put boards down and park the machine on them.
- Drain any water from the fuel tank to prevent freezing.
Refer to page 110 "Draining the Fuel Tank".
- To prevent decreased battery performance, place a cover over the battery or remove it from the machine and store it in a warm place.
Also add battery fluid before starting the next morning. If battery fluid is added after completing operations, the distilled water may not mix, resulting in freezing.

After Cold Weather is Over

Perform the following after cold weather is over:

- Change the fuel and the oils for the different devices with those specified on the Fuel and Lubricant Chart.
Refer to page 90 "Fuel and Lubricant Chart".
- When using one-season type antifreeze coolant, completely drain the antifreeze coolant, carefully clean the inside of the coolant system, then add tap water.
Refer to page 118 "Cleaning the Engine Cooling System".



Handling Rubber Crawlers

Rubber crawlers have an inherent weakness due to their use of rubber. Be sure to heed the prohibitions and cautions below so as to prevent damage to the crawlers and crawler slippage.

Prohibited Actions

Do not travel or operate the machine in the following places:

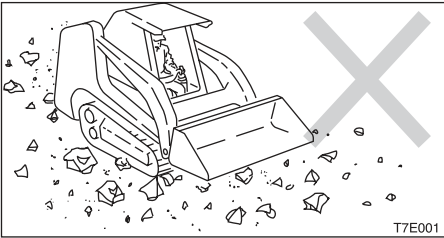

- Traveling or slewing on broken stone, jagged base rock, iron rods, iron scraps or the edges of iron sheets may damage or cut the crawlers.

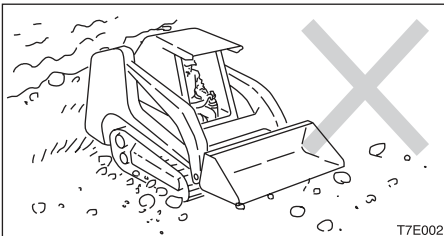

- Traveling on riverbeds or places with many soft rocks may cause the crawlers to slip off or be damaged due to rocks getting stuck in them.
- Do not use on the seashore. The salt may corrode the metal cores.

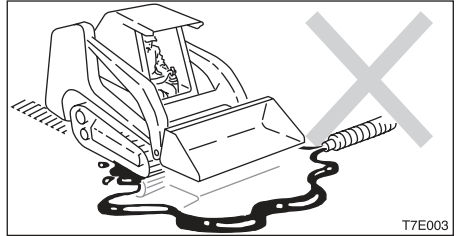

- Do not let fuel, oil, salt or chemical solvents get on the crawlers. These substances may corrode the couplings of the crawlers' metal cores, resulting in rust or peeling. If these substances should get on the crawlers, wipe them off immediately using water.

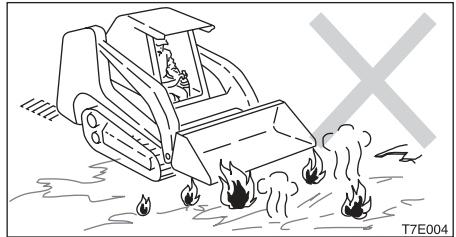

- Traveling on roads directly after asphaltting or on hot surfaces such as over fires or on iron sheets under strong sunlight may result in irregular wear or damage of the lugs.
- Do not move earth in places where the rubber crawlers may slip. Doing so may speed up lug wear.

**Cautions**

Heed the following cautions when operating the machine:

- Avoid changing course abruptly and spinning on concrete surfaces whenever possible.
Doing so may wear or damage the rubber crawlers.
- Avoid drops that may expose the rubber crawlers to strong shocks.
- Salt, potassium chloride, ammonium sulfate, potassium sulfate, and triple superphosphate of lime can damage the crawler belts. If any of these substances should get on the crawler belts, wash them off thoroughly with water.
- Do not let the sides of the rubber crawlers rub against concrete or walls.
- Be especially careful in the winter on snowy or frozen surfaces as the crawler belts tend to slip.
- Use rubber crawler belts at temperatures between -25°C to $+55^{\circ}\text{C}$ (-14°F to 131°F).
- When storing the rubber crawlers for long periods of time (3 months or more), do so indoors in a place not exposed to direct sunlight or rain.

Preventing the Rubber Crawlers from Slipping Off

Heed the following in order to prevent the rubber crawlers from slipping off:

- Always keep the crawlers at the proper tension.

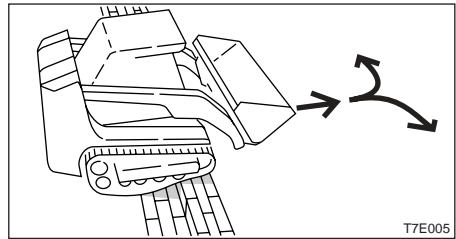

- When traveling up large cobblestone or rock steps (20 cm (8 in.) or greater), climb up the step at a direct angle and do not change course on top of the step.

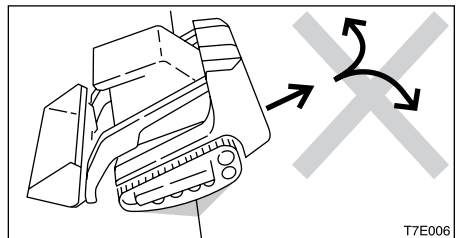

- When climbing in reverse, do not change course at the point where the slope starts.

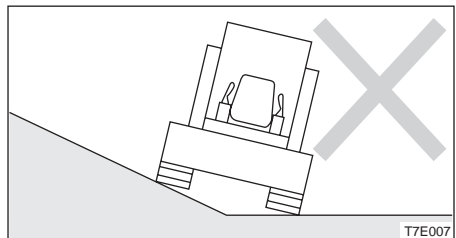

- Avoid traveling with one crawler on a slope or projecting object and the other crawler on a flat surface (with the machine at a tilt of 10° or greater). Travel with both crawlers on flat surfaces.

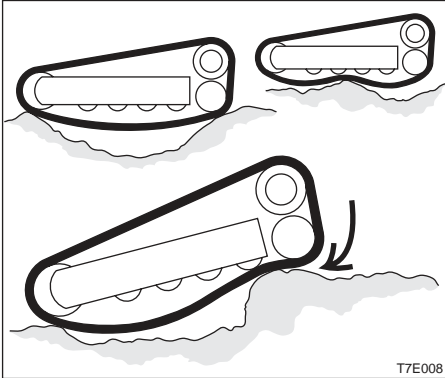

- Do not change directions when the crawler belts are slack as shown in the diagram.



TRANSPORT

Loading and Unloading	84
Securing the Machine	85
Cautions on Transporting	86

**⚠ WARNING**

The machine may roll or tip over or fall while loading or unloading it. Take the following precautions:

- Select a firm, level surface and keep sufficient distance from road shoulders.
- Use loading ramps of adequate strength and size. Maintain the slope of loading ramps within 15 degrees.
- Keep the truck bed and loading ramps clean of oil, clay, ice, snow, and other materials which can become slippery. Clean the tracks.
- Never change course on the ramp.

When loading or unloading the machine, be sure to use ramps and following the procedure below.

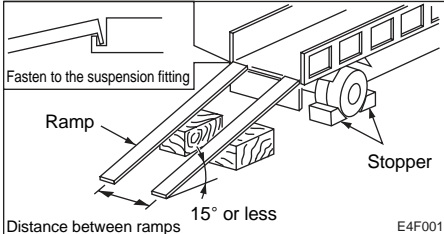

1. Apply the truck's parking brake and place stoppers against its tires.
2. Fasten the ramps securely to the truck bed so that they will not come off. Set the ramps to an angle of 15° or less.
3. Move the machine up or down the ramps with the bucket end facing downward.
4. Line up the center of the truck bed with the center of the machine and the center of the ramps with the center of the crawlers.
5. Make sure the bucket does not hit the ramps.
6. Lower the engine speed.

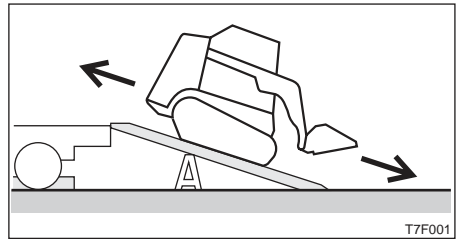

7. Determine the direction on the ramps, then slowly travel up or down the ramps in 1st speed (low speed), following the signals of a flagman.
8. Load the machine properly at the prescribed position on the bed. Refer to page 85 "Transporting Posture".



After loading the machine in the designated position, secure it as described below.

Transporting Posture

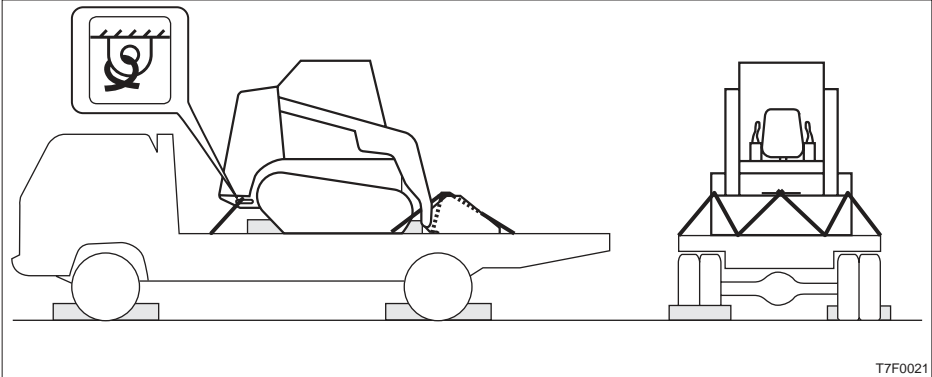

T7F0021

1. Lower the bucket.
2. Stop the engine and remove the starter key.
3. Set the safety bar securely to the locked position.
4. Set stoppers in front and behind the crawlers.
5. Put a chain or wire rope over the lower frame and fasten it securely to prevent sideways slippage.
6. Secure the bucket with a chain or wire rope.



WARNING

- Know and follow the safety rules, vehicle code and traffic laws when transporting the machine.
 - Consider the length, width, height and weight of the truck with the machine loaded on it when determining the best route.
-



MAINTENANCE

General	88
Service Data	90
Important Parts	94
Maintenance Chart	96
Maintenance Log	98
Walk-Around Inspection	100
Daily Inspection (Every 10 Hours).....	102
After First 50 Hours (New Machines Only)	107
Every 50 Hours	111
Every 100 Hours	114
Every 250 Hours	115
After First 500 Hours (New Machines Only)	116
Every 500 Hours	117
Every 1000 Hours	120
Every 2000 Hours	125
When Required	126
Long-term Storage	131



Maintenance Description

For long-term use of the machine under good conditions, perform the inspection and maintenance procedures properly and safely as recommended in this manual.

The inspection and maintenance items are divided according to the machine's total operating time (inspection and maintenance to be performed every 10 hours (walk-around and daily inspection), every 50 hours, every 250 hours, etc.). Refer to the hour meter to determine when it is time to perform inspection and maintenance. Items for which it is not possible to determine the inspection and maintenance interval are included under "When Required".

When operating the machine in extremely harsh environments (with high dust levels or high temperatures), inspection and maintenance should be performed earlier than the times indicated on the Maintenance Chart.

Cautions on Maintenance

Do not perform inspection and maintenance procedures not prescribed in this manual. Have inspection and maintenance procedures not prescribed in this manual performed by a Gehl sales or service outlet.

Always keep the machine clean.

- Always keep the machine clean, and wash it before performing inspection and maintenance.
- When washing the machine with water, stop the engine and cover the electrical system with plastic to protect it from water. Exposing the electrical system to water is dangerous and could result in short-circuits or malfunction. Do not wash the battery, sensors, connectors or the inside of the cab with water or steam.

Fuel, lubricant and grease

- For fuels, lubricant and grease, follow the instructions on the "Fuel and Lubricant Chart".
- Use pure fuels, lubricants and greases which do not contain water, and be careful to keep dirt out when changing or replenishing fuel, lubricant or grease.
- Store fuels, lubricants and greases in the prescribed places and in such a way that no water or dirt can get in them.

Cautions on fueling

- If the port includes a strainer, do not remove the strainer when fueling.
- After fueling, be sure to securely tighten the cap, etc.
- Do not add more than the prescribed amount of fuel.

**Do not clean parts with fuel.**

Do not use fuel to clean parts. Use a non-combustible cleaning agent.

Keep dirt out.

When mounting and removing parts, do so in a place where there is no dust, clean the working area and the part, and keep dirt out.

Clean mounting surfaces.

When mounting and removing parts, be sure that the surfaces of contact of the parts are clean. If the sealing grooves of the surface of contact are damaged, consult a Gehl sales or service outlet.

Seals and split pins

- Replace removed seals and split pins with new ones.
- When mounting, be careful not to damage or twist the seal.

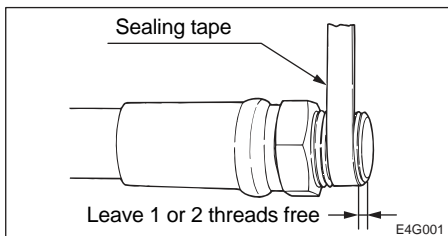
Sealing tape

- When wrapping sealing tape around plugs, etc., remove any old sealing tape from the threads and clean the threads.
- Wrap the sealing tape tight, leaving 1 or 2 threads at the tip free.

Disposing of wastes

- Collect spent fluids from the machine in containers. Disposing of wastes irresponsibly damages the environment.
- Dispose of oil, fuel, cooling water, coolant, filters, batteries and other harmful substances as prescribed by law.

Check after maintenance

- Gradually increase the engine speed from a low idle to maximum speed and check that there is no oil or water leaking from serviced parts.
- Operate all the control levers and check that the machine is operating properly.

Cautions on handling of battery cables

- Disconnect the battery cables (+,-) before working on the electrical system or doing any welding.
Remove the negative (-) battery cable first. When reconnecting the battery, connect the negative (-) battery cable last.
- Do not disconnect the battery cables while the engine is running. Doing so could damage the electronic circuitry of the alternator and other parts.



Fuel and Lubricant Chart

Use different fuels, lubricants and greases according to the temperature, referring to the chart below.

- Change the lubricant earlier than as shown in the table if it is extremely dirty or its performance has deteriorated severely.
- Whenever possible, use the same brand of lubricant as before. If changing with a different brand, replace the entire quantity – do not mix different brands.

Part	Type	Type by temperature								Replacement interval	Capacity Lit. (US. qt.)	
		-22 -30	-4 -20	14 -10	32 0	50 10	68 20	86 30	104 °F 40 °C			
Engine oil pan	Diesel engine oil API-CD					SAE 5W-20					After first 50 hrs. Every 250 hrs.	Upper limit CTL60:10.2(10.8) CTL70:9.6(10.1) CTL80:14(14.8) Lower limit CTL60:5.7(6.0) CTL70:7.6(8.0) CTL80:7(7.4)
Hydraulic tank	Diesel engine oil API-CD					SAE 10W-30					Every 1000 hrs.	System CTL60:60 (15.9 US.gal.) CTL70:83 (21.9 US.gal.) CTL80:95 (25.1 US.gal.) Tank CTL60:39 (10.2 US.gal.) CTL70:52 (13.7 US.gal.) CTL80:64 (16.9 US.gal.)
Fuel tank	Diesel fuel	Use a clean, Quality fuel for good performance and optimum engine life. • To prevent fuel flow problems in cold weather, use diesel fuel with a pour point of at least -12°C (10°F) below the lowest expected ambient temperature. • Minimum cetane number is 45. Low temperature or high altitude operation may require the use of fuel with a higher cetane number.								CTL60:75 (19.8 US.gal.) CTL70:90 (23.8 US.gal.) CTL80:108 (28.5 US.gal.)		
Engine cooling system	Coolant (water**+ coolant***)					30% coolant mixture					Every 1000 hrs.	CTL60:10.9(11.5) CTL70:15(15.9) CTL80:15(15.9)
Travel reduction gear	Gear oil API-GL-4					SAE 90					After first 500 hrs.* Every 1000 hrs.	CTL60:1.1(1.16) CTL70:1.1(1.16) CTL80:1.8(1.9)
Working equipment	Lithium based grease	—								Daily or every 10 hrs.	As required	
Levers and Pedal	EP-2 NLGI No.2									When required		



- * If the percentage of the traveling time within the total operating time is high, replace the gear oil earlier than the specified time.
- ** For water, use tap water (soft). Do not use well or river water.
- *** When the ambient temperature drops below 0°C, add coolant (antifreeze). Follow the coolant manufacturer's instructions to determine the mixture ratio.

Expendables

Replace expendables such as filters and elements periodically, referring to the table below.

Item	Part name	Part No.	Replacement interval
Return filter	Cartridge	181607	After first 50 hrs. Every 500 hrs.
Line filter	Element	180324	
Fuel filter	Cartridge	CTL60 182130 CTL70 182134 CTL80 182088	Every 500 hrs.
CTL70 Feed pump filter	Repair kit	182135	Every 500 hrs.
Engine oil filter	Cartridge	CTL60 182131 CTL70 182136 CTL80 425-34635	After first 50 hrs. Every 250 hrs.
Air cleaner	Outer Element	CTL60 182132 CTL70 182137 CTL80 181879	Every 1000 hrs.
	Inner Element	CTL60 182133 CTL70 182138 CTL80 181881	Every 1000 hrs.



Tools

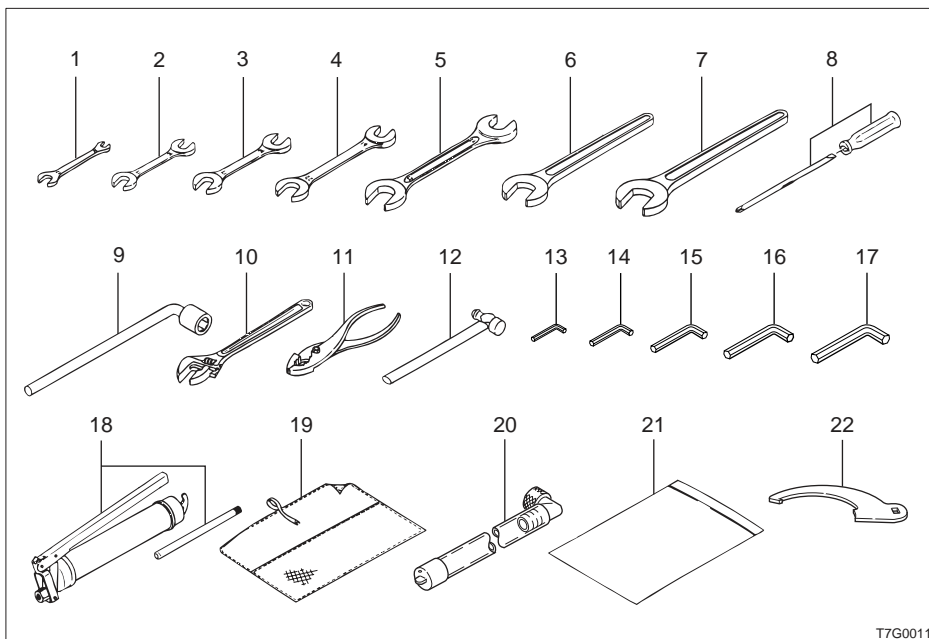

T7G0011

No.	Part name	Part No.	Remarks
1	Spanner		10-12
2	Spanner		11-13
3	Spanner		14-17
4	Spanner		19-22
5	Spanner		24-27
6	Spanner		30
7	Spanner		41
8	Screwdriver		(+) (-)
9	L-type wrench		19
10	Monkey wrench		250mm
11	Pliers		200mm

No.	Part name	Part No.	Remarks
12	Hammer		3/4
13	Hex. wrench		5mm
14	Hex. wrench		6mm
15	Hex. wrench		8mm
16	Hex. wrench		10mm
17	Hex. wrench		14mm
18	Grease gun		600cc
19	Tool case		
20	Drain connector		
21	Case		
22	Filter wrench		



Tightening Torques

Nuts and Bolts (for ISO strength category 10.9)

Tighten nuts and bolts at the torques shown on the table below, unless otherwise specified in the text.

- Tightening torques when mounting plastic covers differ from the values on the table below. Consult a Gehl sales or service outlet. Tightening too strongly will break the cover.
- When replacing nuts and bolts, replace them with nuts and bolts of the same size and standards.
- Tighten nuts and bolts alternately (top, bottom, left then right) or in 2 or 3 times so that they are tightened uniformly.

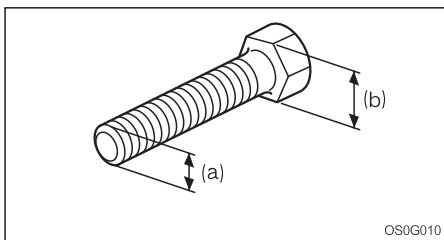
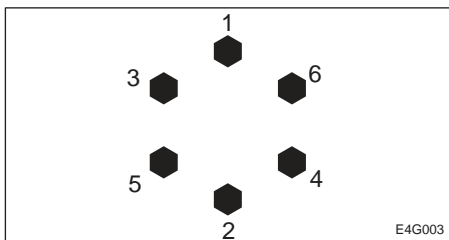

Thread	Head width (b)	Size (a) X Pitch	Torque	
			General Connection Points	
	mm	mm	N-m	ft-lb
Coarse	10	M6 X 1.0	9.8 ± 0.5	7.2 ± 0.4
	12, 13	M8 X 1.25	22.6 ± 1.1	16.6 ± 0.8
	14, 17	M10 X 1.5	47.1 ± 2.4	34.7 ± 1.7
	17, 19	M12 X 1.75	83.4 ± 4.1	61.5 ± 3.0
	19, 22	M14 X 2.0	134.4 ± 6.7	99.1 ± 4.9
	22, 24	M16 X 2.0	207.9 ± 10.4	153.3 ± 7.7
	27, 30	M20 X 2.5	410.9 ± 20.5	303.1 ± 15.1
Fine	12, 13	M8 X 1.0	24.5 ± 1.2	18.1 ± 0.9
	14, 17	M10 X 1.25	50 ± 2.5	36.9 ± 1.8
	17, 19	M12 X 1.5	87.3 ± 4.3	64.4 ± 3.2
	19, 22	M14 X 1.5	135.3 ± 6.8	99.8 ± 5.0
	22, 24	M16 X 1.5	220.6 ± 11	162.7 ± 8.1
	27, 30	M20 X 1.5	452.1 ± 22.6	333.4 ± 16.6



For safe use, the machine must be serviced periodically. To increase safety, periodically replace the parts listed in the following table of important parts.

Serious injury or a fire could result if they deteriorate or are damaged.

Table of Important Parts

Unit		Important parts to be replaced periodically	Replacement Interval
Engine connection		Fuel hoses (fuel lines)	Every 2 years
		Engine oil filter hoses	
		Heater hoses	
		Air conditioner hoses	
Hydraulic system	Main body	Hydraulic hoses (Pump - delivery)	
		Hydraulic hoses (Pump - suction)	
		Hydraulic hoses (Travel motor)	
	Working equipment	Hydraulic hoses (Lift arm cylinder lines)	
		Hydraulic hoses (Bucket cylinder lines)	
		Hydraulic hoses (Pilot valve)	
		Hydraulic hoses (Auxiliary lines)	
	Seat belt	Every 3 years	

Above important parts are vulnerable to aging and wear or deterioration and it is difficult to determine the degree to which they have deteriorated on the occasion of periodic service. To maintain their proper function at all times, therefore, replace them with new ones after using them for a specific period of time even if no abnormality is found with the parts. If you find abnormalities in these parts before their scheduled replacement time is reached, repair or replace them immediately. If a hose clamp is deformed or cracked, replace it immediately. When replacing the important parts, please contact a Takeuchi sales or service outlet .

Also check the hydraulic hoses other than the above important parts. If any abnormality is found in them, retighten them or replace them immediately.

When replacing the hydraulic hoses, replace the O-rings and seals at the same time.

Check the fuel and hydraulic hoses according to the periodic schedule described below. Refer to "Maintenance".

Type of inspection	Inspection item
Daily inspection	Leakages from joints, hydraulic or fuel hoses.
Monthly inspection	Leakages from joints, hydraulic or fuel hoses. Damaged hydraulic or fuel hoses(cracks, wear and tear).
Annual inspection	Leakages from joints, hydraulic or fuel hoses. Deteriorated, twisted, damaged hydraulic or fuel hoses (cracks, wear and tear) or hoses in contact with other parts of the machine.

MEMO



Maintenance Items	See Page
Walk-Around Inspection	
Inspecting by opening the engine hood and rear door	100
Inspecting by walking around the machine	101
Inspecting while sitting in the operator's seat	101
Daily Inspection (Every 10 Hours)	
Inspecting and replenishing the coolant	102
Inspecting and replenishing the engine oil	103
Inspecting the water separator	103
Inspecting the fuel level	104
Inspecting the hydraulic oil level and replenishing	105
Lubricating the working equipment	106
After First 50 Hours (New Machines Only)	
Replacing the hydraulic oil return filter	107
Replacing the engine oil and oil filter	108
Inspecting and adjusting the fan belt	109
Replacing the line filter	110
Every 50 Hours	
Inspecting and adjusting the crawler tension	111
Inspecting the battery fluid level and replenishing	112
Draining the fuel tank	113
Every 100 Hours	
Cleaning the water separator (CTL60 / CTL80)	114
Every 250 Hours	
Replacing the engine oil and oil filter	115
Inspecting and adjusting the fan belt	115



Maintenance Items	See Page
After First 500 Hours (New Machines Only)	
Replacing the travel motor gear oil*	116
Every 500 Hours	
Cleaning the radiator and oil cooler fins	117
Replacing the fuel filter	117
Replacing the feed pump filter (CTL70)	118
Replacing the hydraulic oil return filter	119
Replacing the line filter	119
Every 1000 Hours	
Cleaning the engine cooling system	120
Replacing the air cleaner elements	121
Replacing the hydraulic oil and cleaning the suction strainer	122
Replacing the travel motor gear oil	124
Inspecting and adjusting the engine valve clearance	124
Retightening the engine cylinder head bolts	124
Inspecting the engine fuel injection pressure and spray condition	124
Every 2000 Hours	
Inspecting the engine fuel injection timing	125
Inspecting the engine fuel injection valve	125
When Required	
Replacing the bucket	126
Lubricating the levers	128
Inspecting and replenishing the windshield washer fluid	128
Tilting up the ROPS	129
Inspecting the rubber crawlers	130

* If the percentage of the traveling time within the total operating time is high, replace the gear oil earlier than the specified time.



Perform the following inspections once every day before starting the engine the first time.

WARNING

- Before operating, perform the walk-around inspections and make repairs immediately should any irregularities be found.
- Be sure to secure the engine hood or rear door when opening it. Do not open the engine hood or rear door on slopes or in strong wind.

Before starting the engine, look around the machine and lower body, clean any combustible materials off high temperature parts of the engine, and inspect for such irregularities as oil leakage, water leakage and looseness of nuts and bolts.

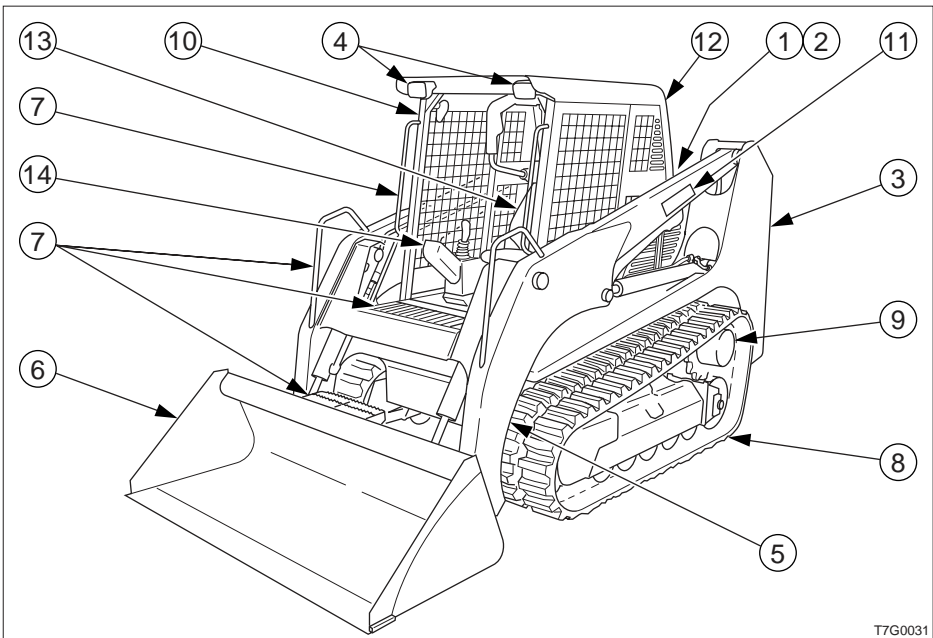

T7G0031

Inspecting by Opening the Engine Hood and Rear Door

1. Check for any twigs, leaves, oil or other combustible materials around the engine and battery.
2. Check for oil or engine coolant water leakage around the engine.
3. Check for oil leakage from the hydraulic tank, hydraulic devices, hoses and connections.



Inspecting by Walking Around the Machine

4. Check lights for dirt, damage and burnt out bulbs.
5. Check attachments and hoses for damage.
6. Check the bucket for wear, damage and looseness.
7. Check the handrail and step for damage and loose bolts.
8. Check the crawler, track roller, idler and sprocket for damage, wear and loose bolts.
9. Check for oil leakage from the travel motor.
10. Check the ROPS and guard for damage and loose nuts and bolts.
11. Check the labels for dirt and damage.

Inspecting While Sitting in the Operator's Seat

12. Check the windshield for dirt or damage. (For machines with front door)
13. Check the operator's seat for dirt, oil or other combustible materials.
14. Check the monitor, instruments and switches for dirt or damage.



Perform the following inspections once every day before starting the engine the first time.

WARNING

- Before operating, perform the Daily inspections and make repairs immediately should any irregularities be found.
- Be sure to secure the engine hood or rear door when opening it. Do not open the engine hood or rear door on slopes or in strong wind.

Inspecting and Replenishing the Coolant**WARNING**

Do not remove the radiator cap or drain plugs when the coolant is hot. Stop the engine, let the engine and radiator cool and loosen the radiator cap or drain plugs slowly.

Replenishing

1. Remove the reserve tank's cap (2).
2. Add coolant up to the upper limit (H) of the reserve tank (1).
If the reserve tank is empty, inspect for fluid leakage, then inspect the radiator (3) coolant level. If it is low, add water to the radiator (3) first, then to the reserve tank.
3. Install the cap (2).

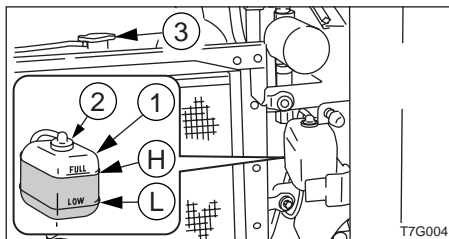
Inspection

1. Open the rear door.
2. Inspect the quantity of coolant in the reserve tank (1).
The level should be between the upper limit (H) and lower limit (L).
If it is below the lower limit (L), replenish.

**Inspecting and Replenishing the Engine Oil****⚠ WARNING**

Stop the engine and allow the machine to cool down before performing inspection and maintenance.

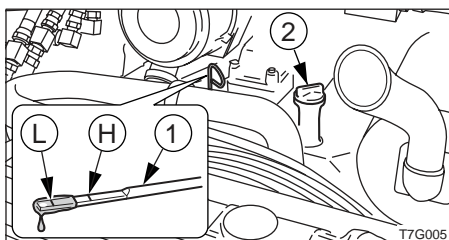
Inspection

1. Open the engine hood.
2. Pull out the dipstick (1) and wipe off the oil with a rag.
3. Fully reinsert the dipstick (1), then pull it back out.
4. Check the oil on the dipstick (1).
The level should be between the upper limit (H) and lower limit (L).
If it is below the lower limit (L), replenish.

Replenishing

1. Remove the oil supply cap (2).
2. Add oil up to the upper limit (H) of the dipstick (1).
Problems could arise if the oil level is either too low or too high.
3. Tighten the oil supply cap (2).
4. Start the engine, run it at low idle for about 3 minutes, then stop it.
5. After about 20 minutes, inspect the oil level.

Inspecting the Water Separator**⚠ WARNING**

Stop the engine and allow the machine to cool down before performing inspection and maintenance.

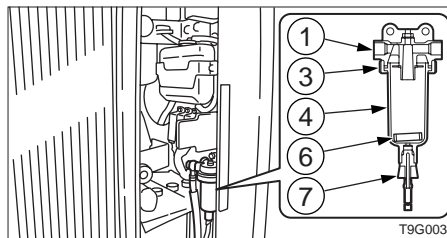
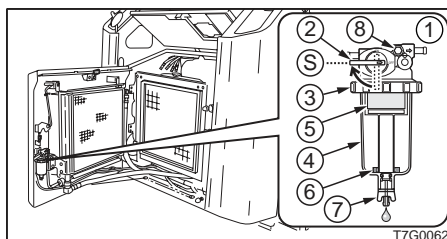
< CTL70 >**< CTL60 / CTL80 >**

Ⓢ : Closed

1. Open the rear door.
2. Inspect the water separator (1).
If the red indicator ring (6) is sunk to the bottom of the case (4), no water is mixed in.
If the red indicator ring (6) is floating, there is water up to the bottom of the ring. Drain the water and clean.
3. Place a pan under the drain valve (7).
4. Open the drain valve (7) and drain the water.
If the water does not drain easily, loosen the vent plug (8).
5. Close the drain valve (7) and vent plug (8).

**< CTL60 / CTL80 >**

Refer to page 114 "Cleaning the Water Separator".

Inspecting the Fuel Level**⚠ WARNING**

- Do not smoke or permit open flames while fueling or near fueling operations.
- Stop the engine in a well-ventilated place when adding fuel.
- Clean up spilled fuel immediately.
- Do not fill the fuel tank to capacity. Allow room for expansion.
- Tighten the fuel filler cap securely.

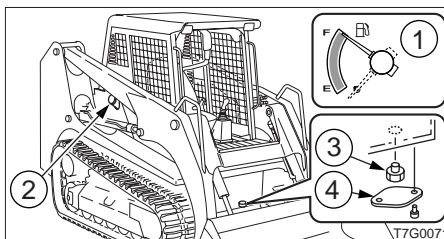

1. Check the fuel level using the fuel gauge (1).
F: full
E: empty
2. If the level is low, add fuel from the fuel port (2) while watching the fuel gauge (1). Refer to page 41 "Fuel Filler Cap".



Inspecting the Hydraulic Oil Level and Replenishing

Inspection

The oil level changes according to the oil temperature. Inspect the oil level in the hydraulic oil level inspection posture shown in the diagram.

- Hydraulic oil level inspection posture

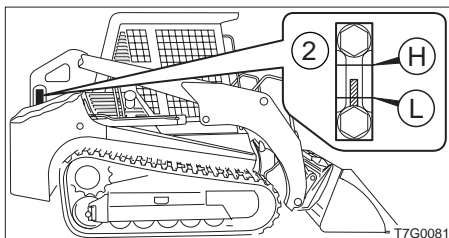

1. Start the engine and run it at low speed.
2. Fully retract the lift arms and bucket cylinders and ground the bucket.
3. Stop the engine.
4. Inspect the oil level using the sight gauge (2).

- When the oil temperature is about 20°C (68°F):

The level should be halfway between the upper limit (H) and lower limit (L).

If it is below the lower limit (L), replenish.

- When the oil temperature is about 50 to 80°C (122 to 176°F):

The level should be near the upper limit (H).

Replenishing

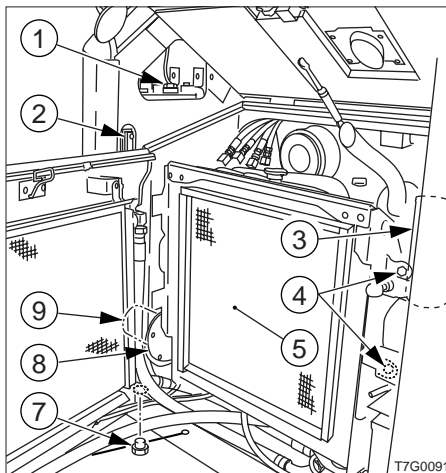

1. Remove the plug (1).
2. Add hydraulic oil up to the middle of the sight gauge (2).
3. Tighten the plug (1).



Lubricating the Working Equipment

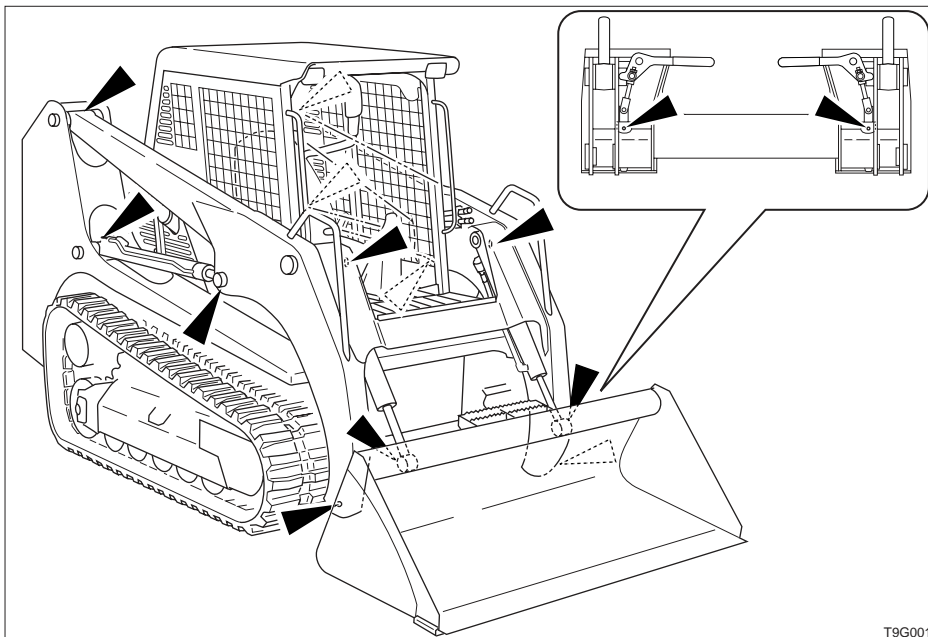

T9G001

1. Set the machine to the lubrication posture shown in the diagram above, ground the bucket, then stop the engine.
2. Use the grease gun to lubricate the grease nipples.
3. Wipe off the expelled grease.



Replacing the Hydraulic Oil Return Filter

⚠ WARNING

- Stop the engine and allow the machine to cool down before performing maintenance.
- The engine, hydraulic lines and many other parts of the machine are hot directly after the engine is stopped. Touching these parts will cause burns.
- The hydraulic fluid is also hot and under high pressure. Be careful when loosening caps and plugs. Working on the machine under these conditions could result in burns or injuries due to the hot oil spurting out.
- Oil may spurt out if caps or filters are removed or pipes disconnected before releasing the pressure in the hydraulic system.
- When removing plugs or screws or disconnecting hoses, stand to the side and loosen slowly to gradually release the internal pressure before removing.

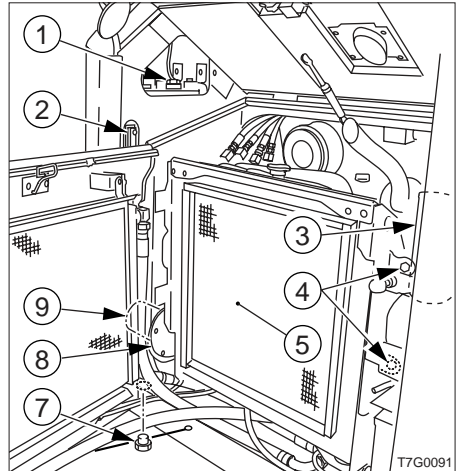
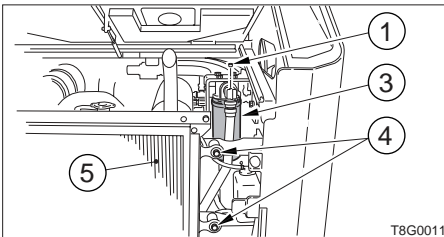

1. Open the rear door.
2. Remove the plugs (1).
3. Using a filter wrench, turn the return filter (3) counterclockwise and remove it.
4. Clean the surface of installation of the filter stand.
5. Apply a thin layer of oil to the packing of the new filter.
6. Install the new return filter by hand.
7. Tighten 2/5 more turn with the filter wrench after the filter packing comes in contact with the surface of installation.
8. Inspect the level with the sight gauge (2), and replenish if the level is low. Refer to page 105 "Inspecting the Hydraulic Oil Level and Replenishing".
9. Tighten the plugs (1).



Replacing the Engine Oil and Oil Filter

WARNING

Stop the engine and allow the machine to cool down before performing maintenance.

- The engine, muffler, radiator and many other parts of the machine are hot directly after the engine is stopped. Touching these parts will cause burns.
- The engine oil is also hot. Be careful when loosening caps and plugs. Working on the machine under these conditions could result in burns.

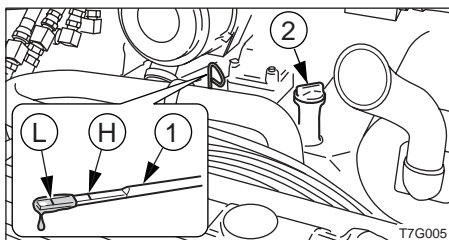

1. Open the engine hood.
2. Tilt up the ROPS.
Refer to page 129 "Tilting Up the ROPS".
3. Remove the oil supply cap (2).

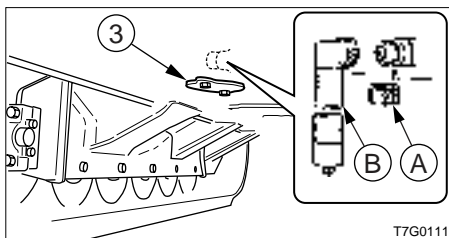

4. Place a pan under the under cover (3).
5. Loosen the bolts and remove the under cover (3).
6. Remove cap (A), install connector (B) and drain the oil. (The oil comes out when the screw is tightened.)

7. Remove connector (B) and install cap (A).

IMPORTANT: Check the spent oil. If it contains large amounts of metal powder, consult a Gehl sales or service outlet.

8. Install the under cover (3).

< CTL70 >

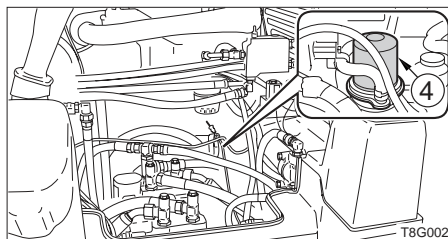

< CTL60 / CTL80 >

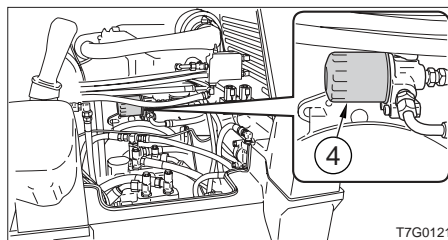

9. Using a filter wrench, turn the filter (4) counterclockwise and remove it.
10. Clean the surface of installation of the filter stand.
11. Apply a thin layer of oil to the packing of the new filter.
12. Install the new filter by hand.
13. Tighten 3/4 (CTL70: 1 and 1/4) more turns with the filter wrench after the filter packing comes in contact with the surface of installation.
14. Supply oil up to the upper limit (H) of the dipstick (1). Problems could arise if the oil level is either too low or too high.
15. Tighten the oil supply cap (2).
16. Lower the ROPS.



17. Start the engine, run it at low idle for about 3 minutes, then stop it.
18. After about 20 minutes, inspect the oil level.

Inspecting and Adjusting the Fan Belt

WARNING

Stop the engine and allow the machine to cool down before performing inspection and maintenance.

- The engine, muffler, radiator, hydraulic lines, sliding parts and many other parts of the machine are hot directly after the engine is stopped. Touching these parts will cause burns.

Inspection

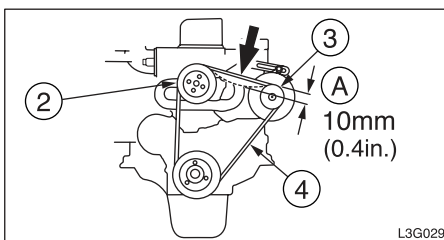
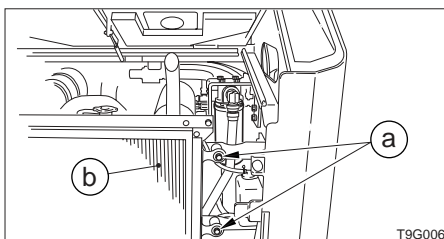

1. Open the rear door.
2. Remove the bolts (a) and open the radiator (b).
3. Press at the center of the fan pulley (2) and alternator pulley (3) and check the tension (about 10 kg or 22 lb.).
The slack (A) should be about 10 mm (0.4 in.).
4. Inspect the fan belt (4) and replace it if:
 - there are cuts or cracks.



- the belt is worn and touches the bottom of the V groove in the pulley.
- the belt stretches and cannot be adjusted.

Adjustment

< CTL60 / CTL80 >

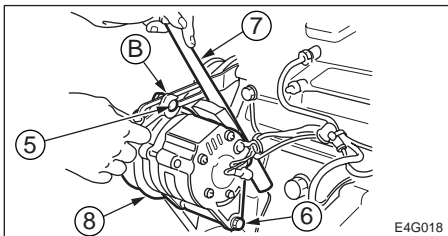

1. Loosen the adjustment bolt (5) and locking nut (6).
2. Using a lever (7), move the alternator (8) and adjust the slack.
3. Tighten the adjustment bolt (5) and locking nut (6).

< CTL70 >

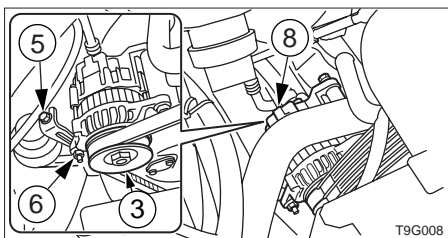

1. Loosen the locking nut (6).
2. Turn the adjustment bolt (5) and adjust the fan belt (4).
 - Tighten: Clockwise
 - Loosen: Counterclockwise
3. Tighten the locking nut (6).

Replacing the Line Filter



WARNING

- Stop the engine and allow the machine to cool down before performing maintenance.
- Oil may spurt out if caps or filters are removed or pipes disconnected before releasing the pressure in the hydraulic system.
- When removing plugs or screws or disconnecting hoses, stand to the side and loosen slowly to gradually release the internal pressure before removing.

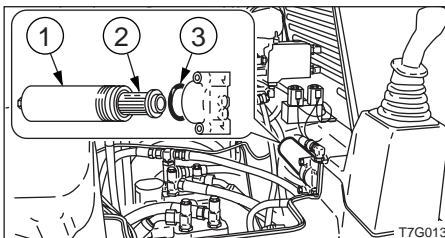

1. Tilt up the ROPS.
Refer to page 129 "Tilting Up the ROPS".
2. Turn the case (1) counterclockwise and remove it.
3. Remove the element (2) and O-ring (3).
4. Clean the inside of the case (1).
5. Install the new element in the case (1).
6. Set the new O-ring, then tighten the case (1).



Inspecting and adjusting the Crawler Tension

⚠ WARNING

- If you must work beneath the raised machine or equipment, always use wood blocks, jack-stands or other rigid and stable supports. Never get under the machine or working equipment if they are not sufficiently supported. This procedure is especially important when working on hydraulic cylinders.
- The track adjuster contains highly pressurized grease. If the tension is adjusted without following the prescribed procedure, the grease discharge valve may fly off, resulting in injury.
 - Loosen the grease discharge valve slowly.
 - Do not put your face, arms, legs or body in front of the grease discharge valve.
 - If no grease is expelled when grease discharge valve is loosened, there is a problem. Contact your nearest service outlet for repairs. **DO NOT** disassemble, as this is very dangerous.

Inspection

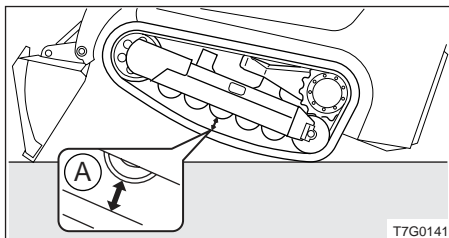

1. Lower the lift arm and tilt the bucket forward to raise the front of the loader off the ground as far as it will go.

2. Measure the clearance between the center track roller and the surface of the crawler belt where it makes contact with the roller.

The gap (A) should be within the following range:

15 to 25mm (0.6 to 1.0 in.)

Adjustment

Increasing the tension

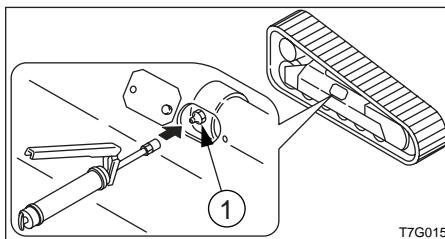

3. Remove the cover.
4. Using the grease gun, insert grease through the grease nipple in the grease discharge valve (1).
5. Inspect the crawler tension.

Decreasing the tension

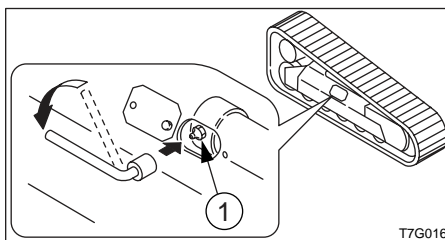

3. Remove the cover.
4. Using the L-type wrench, slowly loosen the grease discharge valve (1) and drain the grease.

If the grease does not drain easily, move the machine forward or backward.
5. Tighten the grease discharge valve (1).
 - Tightening torque: 59 N·m (43.4 ft·lb.)



Inspecting the Battery Fluid Level and Replenishing

DANGER

- Do not use the battery when the fluid level is below the lower level. Doing so will hasten the deterioration of the internal portions of the battery and shorten the battery life, and can also cause rupturing (or an explosion).
- Batteries generate flammable and explosive gases. Keep arcs, sparks, flames and lighted tobacco away.

WARNING

- Do not fill the battery above the upper level. Doing so could cause the fluid to leak, contact and damage the skin, or cause parts to corrode.
- Batteries contain sulfuric acid which will damage eyes or skin on contact.
 - If acid contacts eyes, flush immediately with clean water and get prompt medical attention.
 - If acid is accidentally swallowed, drink large quantities of water or milk and call a physician immediately.
 - If acid contacts skin or clothing, wash off immediately with clean water.

Inspection

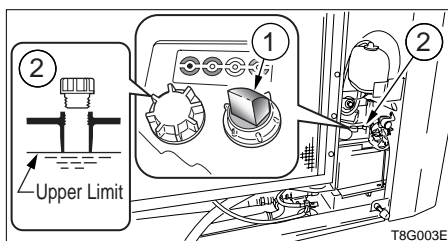

1. Open the rear door.

2. Inspect the indicator (1).
 - Blue: Charging complete
 - White: OK
 - Red/center White:
Insufficient battery fluid
 - Red/center Red: Charging needed
3. Also check the terminals for looseness and dirt.

Replenishing

When adding distilled water, do so before starting operations in order to prevent freezing.

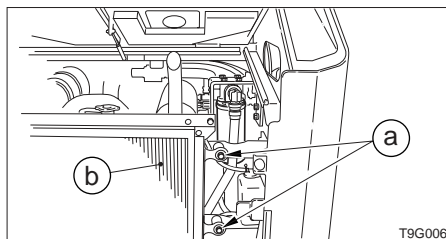

1. Remove the bolts (a) and open the radiator (b).
2. Remove the indicator (1) and caps (2), and add distilled water up to the upper level.
3. Tighten the indicator (1) then it turns green.
4. Clean the cap's exhaust hole, then tighten the caps (2) securely.



Draining the Fuel Tank

WARNING

- Do not smoke or permit open flames while handling fuel or working on the fuel system.
- Stop the engine in a well-ventilated place and allow it to cool down before performing maintenance.
- Clean up spilled fuel immediately.

Do this before operating the machine.

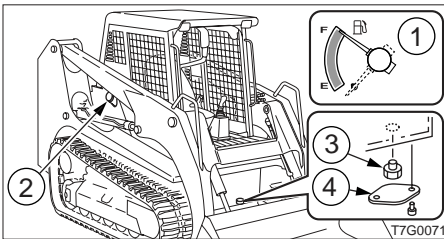

1. Remove the fuel filler cap (2).
2. Place a pan under the drain plug (3).
3. Remove the cover (4).
4. Remove the drain plug (3) and drain the water and sediment from the bottom of the tank.
5. Tighten the drain plug (3).
6. While watching the fuel gauge (1), add fuel.
7. Tighten the fuel filler cap (2) and lock it with the key.

Bleeding the air from the fuel system

Refer to page 137 "Bleeding the Air from the Fuel System".

Supplement: Air in the fuel system can make it difficult to start the engine and cause engine problems. Also bleed the air when the fuel tank is emptied.



Cleaning the Water Separator (CTL60 / CTL80)

WARNING

- Do not smoke or permit open flames while handling fuel or working on the fuel system.
- Stop the engine in a well-ventilated place and allow it to cool down before performing maintenance.
- Clean up spilled fuel immediately.

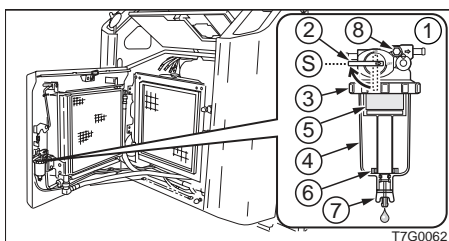

Ⓢ : Closed

1. Open the rear door.
2. Close the valve (2).
3. Loosen the ring (3), then remove the case (4), element (5) and indicator ring (6) and clean them.
4. Inspect the O-ring, and if there are any scratches or other irregularities, replace it.
5. Assemble the indicator ring (6), case (4) and element (5) and tighten the ring (3).
6. Open the valve (2).
7. Loosen the vent plug (8) and bleed the air.
8. Tighten the vent plug (8).

Refer to page 137 "Bleeding the Air from the Fuel System".



Replacing the Engine Oil and Oil Filter

Refer to page 108 “Replacing the Engine Oil and Oil Filter”.

Inspecting and Adjusting the Fan Belt

Refer to page 109 “Inspecting and Adjusting the Fan Belt”.



Replacing the Travel Motor Gear Oil

WARNING

- Stop the engine and allow the machine to cool down before performing maintenance.
 - The travel motors are hot directly after the engine is stopped. Touching them will cause burns.
 - The gear oil is also hot and under high pressure. Be careful when loosening plugs. Working on the machine under these conditions could result in burns or injuries.
- The pressure in the travel motor reduction gears case may cause oil or the plug to fly out. Loosen the plug slowly to release the pressure.

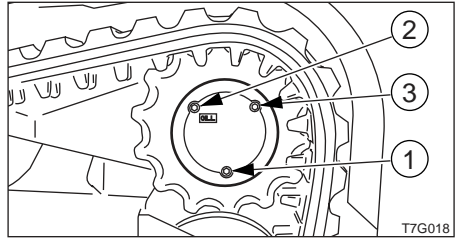

1. Set the travel motor so that plug (1) is at the very bottom.
2. Place a pan for catching the spent oil under plug (1).
3. Remove plugs (1), (2) and (3) and drain the oil.
4. Wrap new sealing tape around the plugs.
5. Tighten plug (1).
6. Supply oil through the hole for plug (3) until oil flows out of the hole of plug (2).
7. Tighten plugs (2) and (3).

IMPORTANT: If the percentage of the traveling time within the total operating time is high, replace the gear oil earlier than the specified time.



Cleaning the Radiator and Oil Cooler Fins

WARNING

Wear required appropriate equipment such as safety glasses and filter mask when using compressed air, as metal fragments or other objects can fly and cause serious personal injury.

IMPORTANT: To prevent damaging the fins with the compressed air, do not hold the nozzle close to the fins. Also, do not spray highly pressurized water directly at the fins.

When using water, cover the electrical system to prevent water from getting in.

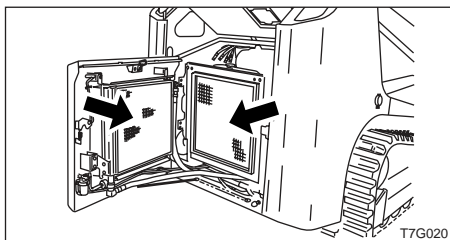

1. Open the rear door.
2. Blow compressed air on the radiator and oil cooler fins to remove mud and dirt stuck on them. Do not use steam or water instead of compressed air.

Replacing the Fuel Filter

WARNING

- Do not smoke or permit open flames while handling fuel or working on the fuel system.
- Stop the engine in a well-ventilated place and allow it to cool down before performing maintenance.
- Clean up spilled fuel immediately.

< CTL60 / CTL80 >

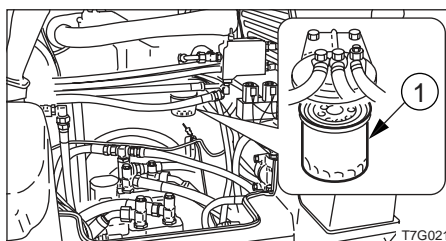

1. Tilt up the ROPS.

< CTL70 >

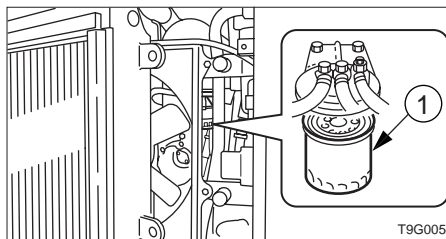

1. Open the radiator.
2. Place a pan under the filter (1).
3. Using a filter wrench, turn the filter (1) counterclockwise and remove it.
4. Clean the surface of installation of the filter stand.
5. Apply a thin layer of oil to the packing of the new filter.



6. Install the new filter by hand.
7. Tighten 2/3 more turn with the filter wrench after the filter packing comes in contact with the surface of installation.
8. Bleed the air.
Refer to page 137 "Bleeding the Air from the Fuel System".

Replacing the Feed Pump Filter (CTL70)

WARNING

- Do not smoke or permit open flames while handling fuel or working on the fuel system.
- Stop the engine in a well-ventilated place and allow it to cool down before performing maintenance.
- Clean up spilled fuel immediately.

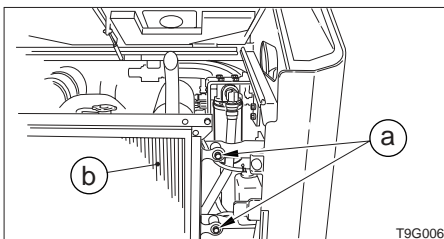

1. Open the rear door.
2. Remove the bolts (a) and open the radiator (b).

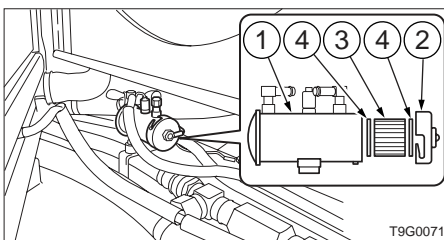

3. Place a pan under the feed pump (1).
4. Remove the cover (2).
5. Remove the element (3) and gaskets (4).
6. Install the new element and gaskets.
7. Tighten the cover (2).



Replacing the Hydraulic Oil Return Filter

Refer to page 107 "Replacing the Hydraulic Oil Return Filter".

Replacing the Line Filter

Refer to page 110 "Replacing the Line Filter".



Cleaning the Engine Cooling System

⚠ WARNING

- Stop the engine and allow the machine to cool down before performing maintenance.
- The engine, muffler, radiator and many other parts of the machine are hot directly after the engine is stopped. Touching these parts will cause burns.
- The engine coolant is also hot and under high pressure. Be careful when loosening caps and plugs. Working on the machine under these conditions could result in burns or injuries due to the hot coolant spurting out.
- If maintenance must be performed with the engine running, always work as a two-person team with one person sitting in the operator's seat while the other works on the machine.
- When performing maintenance, be sure to keep your body and clothing away from moving parts.
- Standing at the back of the machine while the engine is running is extremely dangerous, as the machine could move suddenly. Never stand at the back of the machine while the engine is running.
- Do not remove the radiator cap or drain plugs when the coolant is hot. Stop the engine, let the engine and radiator cool and loosen the radiator cap or drain plugs slowly.

1. Open the rear door and remove the cover (5).

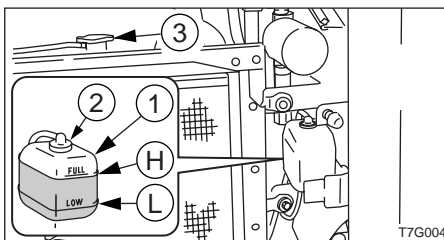

2. Gradually loosen the radiator cap (3) to release the internal pressure, then remove.

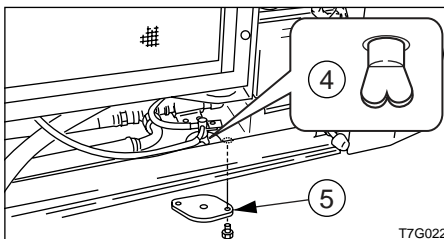

3. Place a pan for catching the spent coolant under the drain plug (4), then loosen the drain plug (4) and drain the coolant.
4. Tighten the drain plug (4), then add a little cleaning agent and tap water to the radiator until it is full. Take your time doing this.
Follow the manufacturer's instructions when using the cleaning agent.
5. Run the engine at a low idle for about 30 minutes. For the first 5 minutes after starting it, pay attention to the level of the cleaning fluid, and add tap water if the level drops.
6. Stop the engine and drain the cleaning fluid.
7. Tighten the drain plug (4), add tap water, run the engine at a low idle for about 10 minutes, then stop the engine and drain the water.
Clean repeatedly until the drained water is clear.



8. After cleaning is completed, tighten the drain plug (4) and add new coolant up to the specified level.
9. Run the engine at a low idle, bleed the air, then stop the engine once the coolant level stabilizes at the specified level.
10. Check the coolant level, then tighten the radiator cap (3).
11. Clean the inside of the reserve tank (1), then add coolant up to the upper limit (H).

Replacing the Air Cleaner Elements

WARNING

Stop the engine and allow the machine to cool down before performing maintenance.

- **The engine, muffler, radiator and many other parts of the machine are hot directly after the engine is stopped. Touching these parts will cause burns.**

IMPORTANT: Do not use an element if its flutes, gaskets or seals are damaged.

1. Open the engine hood.

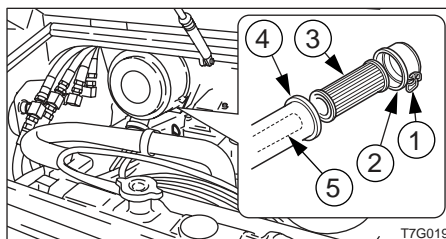

2. Loosen the clamp (1) and remove the dust cup (2).
3. Clean the inside of the dust cup (2).
4. Remove the outer element (3).
Do not yet remove inner element (5).
5. Clean the inside of the body (4).
6. Remove the inner element (5).
7. Install the new elements.
8. Install the dust cup (2) with the TOP mark at the top, then fasten it with the clamp (1).



Replacing the Hydraulic Oil and Cleaning the Suction Strainer

⚠ WARNING

- Stop the engine and allow the machine to cool down before performing maintenance.
- The engine, hydraulic lines and many other parts of the machine are hot directly after the engine is stopped. Touching these parts will cause burns.
- The hydraulic fluid is also hot and under high pressure. Be careful when loosening caps and plugs. Working on the machine under these conditions could result in burns or injuries due to the hot oil spurting out.
- Oil may spurt out if caps or filters are removed or pipes disconnected before releasing the pressure in the hydraulic system.
- When removing plugs or screws or disconnecting hoses, stand to the side and loosen slowly to gradually release the internal pressure before removing.

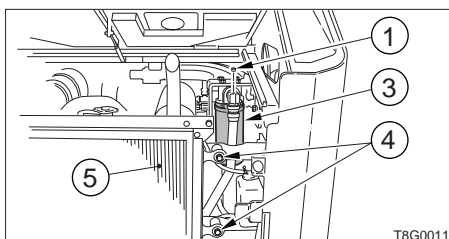

1. Open the rear door
2. Drain the coolant
Refer to page 120 "Cleaning the Engine Cooling System".
3. Remove the bolts (4) and open the radiator (5).
4. Disconnect the hoses that are connected to the radiator (5).
5. Temporarily suspend the radiator (5).
6. Remove the split pin and pull out pins (6).
7. Lift out the radiator and remove it.

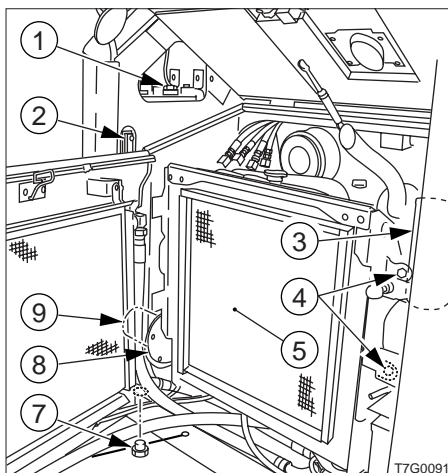

8. Remove the plugs (1).
9. Remove the return filter (3).
10. Place a pan for catching the spent oil under the drain plug (7).
Loosen the drain plug (7) and drain the hydraulic oil.



11. Loosen the bolts, and remove the flange (8).
12. Remove the suction strainer (9) and clean it.
13. Clean the inside of the hydraulic tank.
14. Install the new return filter.
Refer to page 107 "Replacing the Hydraulic Oil Return Filter".
15. Install the suction strainer (9) to the flange (8).
16. Install the flange (8).
17. Tighten the drain plug (7).
18. Add hydraulic oil up to the middle of the sight gauge (2) from the hole of plug (1).
19. Tighten the plugs (1).
20. Follow the procedure next "Bleeding the air" to bleed the air from the hydraulic oil circuit.
21. Set the machine to the hydraulic oil level inspection posture and inspect the level once the temperature of the oil has dropped.
Refer to page 105 "Inspecting the Hydraulic Oil Level and Replenishing".

Bleeding the air

IMPORTANT: After replacing the hydraulic oil, bleed the air from the hydraulic circuit and hydraulic devices. Failure to do so may damage the hydraulic devices.

● Hydraulic pump

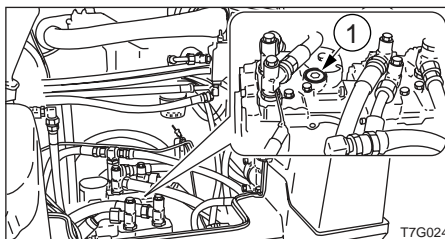

1. Tilt up the ROPS.
2. Remove the plug (1) from the hydraulic pump.
3. Once hydraulic oil overflows from the plug hole, connect the plug (1).

● Cylinders

1. Start the engine and run it at low idle for 10 minutes.
2. Set the engine to a low idle, then extend and contract all the cylinders 4 or 5 times, without going to the stroke end.
3. Run the engine at high speed, then extend and contract all the cylinders 4 or 5 times, without going to the stroke end.
4. Set the engine back to a low idle, then extend and contract all the cylinders 4 or 5 times to the stroke ends.



Replacing the Travel Motor Gear Oil

Refer to page 116 “Replacing the Travel Motor Gear Oil”.

Inspecting and Adjusting the Engine Valve Clearance

This operation requires experience. Have it performed by a Gehl sales or service outlet.

Retightening the Engine Cylinder Head Bolts

This operation requires experience. Have it performed by a Gehl sales or service outlet.

Inspecting the Engine Fuel Injection Pressure and Spray Condition

This operation requires experience. Have it performed by a Gehl sales or service outlet.



MAINTENANCE

Every 2000 Hours

Inspecting the Engine Fuel Injection Timing

This operation requires experience. Have it performed by a Gehl sales or service outlet.

Inspecting the Engine Fuel Injection Valve

This operation requires experience. Have it performed by a Gehl sales or service outlet.



Replacing the Bucket or Attachment

⚠ WARNING

Before performing maintenance or repairs under the machine, set all working equipment against the ground or in the lowermost position.

Installation

IMPORTANT: Read the manufacturer's instructions manual for attachments not included in this manual. DO NOT use attachments that are not approved by Gehl.

IMPORTANT: Before installing a bucket or attachment, make sure the mounting area of the bucket (1) and the quick attachment (3) are clean.

1. Make sure the quick attachment (3) lock levers (2) are in the unlocked position.

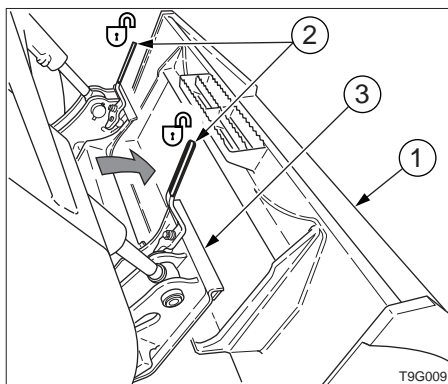

2. While sitting in the operator's seat with the safety bar down, start the engine and tilt the quick attachment (3) forward.

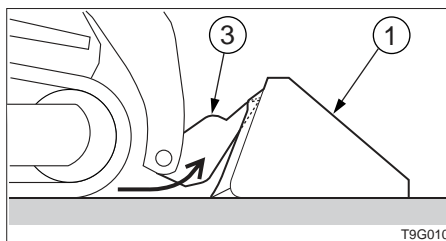

3. Move the machine slowly forward and raise the loader lift arms. The wedge shaped top edge of the quick attachment (3) must engage in the upper mounts of the bucket or attachment.

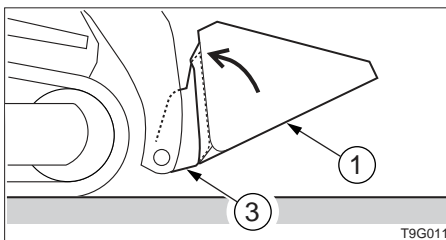

4. Roll the quick attachment (3) back while lifting the bucket or attachment off the ground. The quick attachment (3) will slide into position.
5. Lower the bucket or attachment until it is 25 to 50 mm (1 to 2 in.) off the ground.
6. Stop the engine and raise the safety bar.

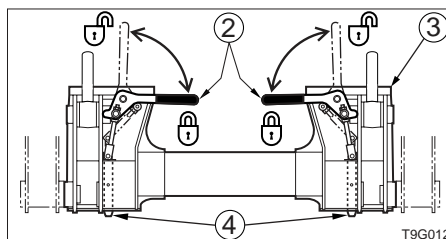

7. Push both quick attachment (3) lock levers (2) down securing the bucket or attachment in position.



IMPORTANT: Before operating the machine, always inspect the quick attachment latch pin (4) engagement by raising the loader arms high enough to view the latch pin (4) engagement from the operator's seat.

Supplement: If the quick attachment (3) lock levers (2) do not lower into the LOCKED position, remove the attachment and investigate the cause.

Removal

1. Raise the bucket (1) or attachment 25 to 50 mm (1 to 2 in.) off the ground.
2. Stop the engine, raise the safety bar and release the seat belt.

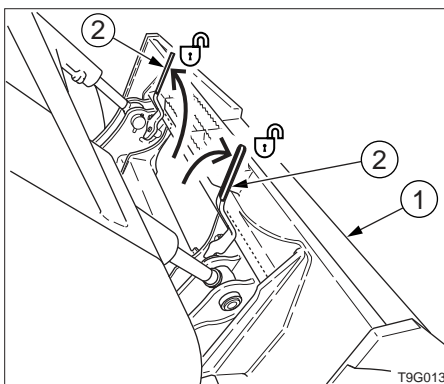

3. Pull both attachment lock levers (2) upward to disengage the bucket (1) or attachment.
4. Return to the operator's seat, lower the safety bar, fasten the seat belt and start the engine.

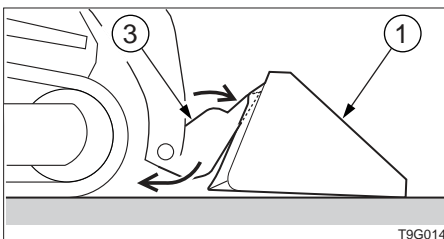

5. Rotate the quick attachment (3) out (bucket dump function) allowing the bucket or attachment to slide off the top edge of the quick attachment (3).

**Lubricating the Levers****⚠ WARNING**

Set the machine to the parking posture, stop the engine, remove the starter key and store it. Failure to do so may result in the machine moving abruptly, leading to serious injury or death.

If the levers or pedal no longer move smoothly, supply grease.

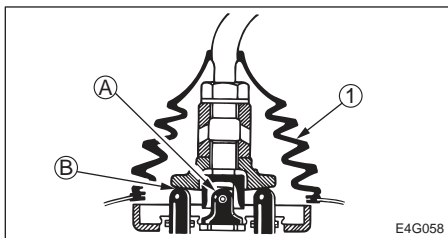
Control levers

E4G058

1. Remove the lower mount section of the boot (1) and turn it upwards.
2. Wipe off the old grease.
3. Supply grease to points (A) and (B).
4. Set the boot (1) back as it was.

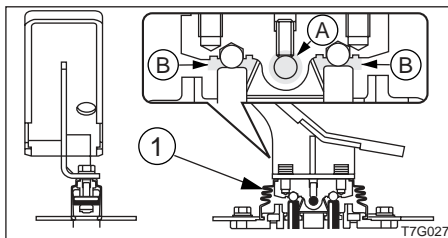
Auxiliary pedal

T7G027

1. Remove the lower mount section of the boot (1) and turn it upwards.
2. Wipe off the old grease.
3. Supply grease to points (A) and (B).
4. Set the boot (1) back as it was.

Inspecting and Replenishing the Windshield Washer Fluid

Use a windshield washer fluid designed specifically for motor vehicles. Follow the instructions including with the washer fluid.

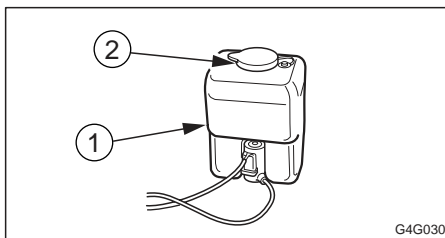

G4G030

Inspection

1. Open the front door.
2. Inspect the washer tank (1) and add washer fluid if the level is low.

Replenishment

1. Mix the washer fluid to the prescribed concentration.
2. Remove the cap (2) and add washer fluid.
3. Reinstall the cap (2).



Tilting Up the ROPS

For inspection and maintenance, the ROPS is designed so that it can be tilted up.

WARNING

- Raising or lowering the ROPS while the engine is running may cause the machine to move, and cause serious injury or death. Lower the working equipment to the ground and stop the engine before raising or lowering the ROPS.
- When the ROPS is tilted up, support it firmly with the stopper to prevent it from falling.

Raising (Tilt up)

1. Select a firm, level surface, lower the working equipment to the ground, and stop the engine.
2. Set the safety bar to the lock position.

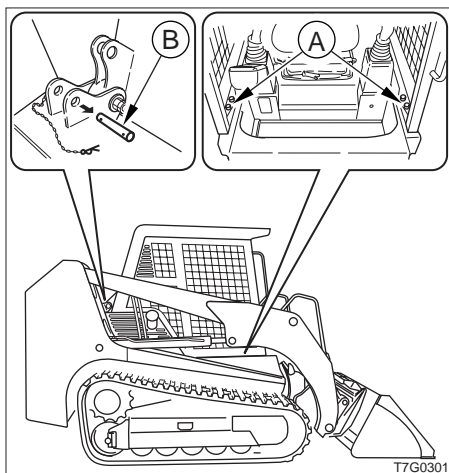

3. Remove a R-pin and remove the stopper pin (B).
4. Remove the lock bolts (A).
5. Slowly raise the ROPS.

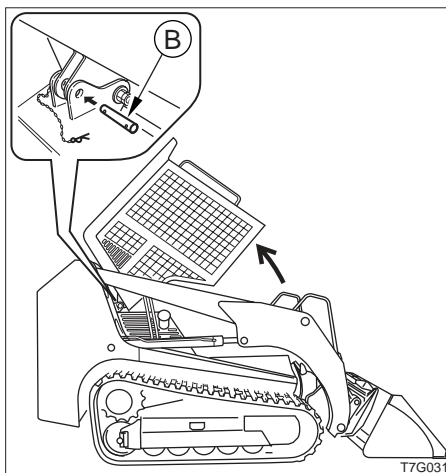

6. Insert the stopper pin (B) into the body's holder and insert a R-pin into the stopper pin's hole to fasten it in place. If you need to run the engine while the ROPS is raised follow these steps.
7. Make sure that all levers and pedal are in neutral positions.
8. Push the throttle lever to the low idling position.
9. Start the engine.
10. Be sure to stop the engine after inspection and maintenance.

Lowering

1. Remove the stopper pin (B).
2. Lower the ROPS.
3. Tighten the lock bolts (A).
4. Reinsert the stopper pin (B) into the body's holder.



Inspecting the Rubber Crawlers

Repair or replace the rubber crawlers if their conditions are as described below. Consult a Gehl sales or service outlet about repairs or replacement.

Rubber crawler

Replace the crawler if the entire crawler is stretched and cannot be adjusted.

(1) Lug

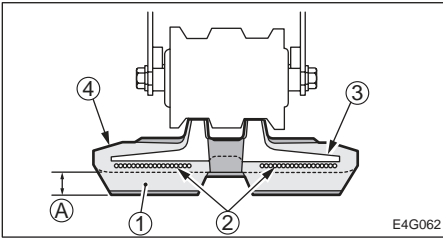

Replace if the height of (A) is 5 mm (0.2 in.) or below.

(2) Steel cord

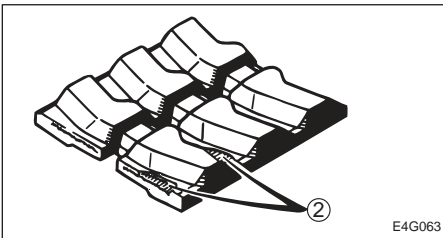

Replace if the steel cord is exposed over 2 or more links.

Replace if half or more of the steel cords on one side are cut.

(3) Metal core

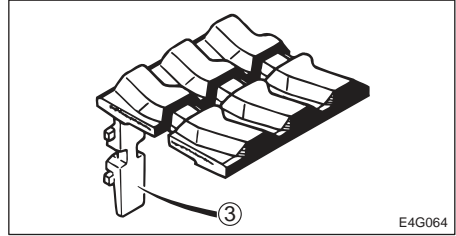

Replace if even one metal core is off.

(4) Rubber

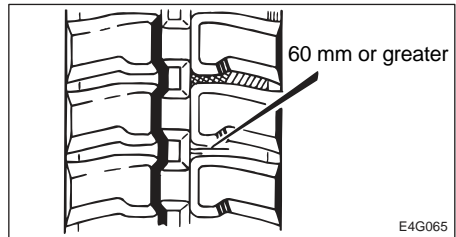

Repair if there are cracks of 60 mm (2.4 in.) or greater in length.

If the steel cord is visible, repair as soon as possible, regardless of the length of the crack.

**Procedures for storage**

If the machine is to be stored for 30 days or more, store it indoors. If it must be stored outdoors, stop it on wood laid out on a flat surface and place a waterproof cover over it so that it stays dry.

1. Clean the machine.
2. Inspect for oil leakage, water leakage and loose nuts and bolts.
3. Add fuel and replace the hydraulic oil and oil.
4. To prevent rusting and freezing, replace the engine coolant with long-life coolant (LLC).

Refer to page 120 "Cleaning the Engine Cooling System".

5. Use the grease gun to supply grease to the grease nipples.
6. Fully retract the bucket cylinders and ground the bucket.
7. Apply rust-prevention oil to the hydraulic cylinder rods.
8. Disconnect the cable from the battery's "-" terminal and cover the battery to prevent freezing.

During storage**! WARNING**

- **Do not operate the engine in an enclosed area without adequate ventilation.**
 - **If natural ventilation is poor, install ventilators, fans, exhaust extension pipes or other artificial venting devices.**
-

1. To prevent rusting, operate the machine once a month so that the oil is fully circulated.
2. Inspect the battery and recharge it if necessary.
Have the battery charged by a Gehl sales or service outlet.

Starting the machine after storage

IMPORTANT: If the "Procedures for storage" have not been performed and the machine has been stored for a long period of time, consult a Gehl sales or service outlet before reusing the machine.

1. Wipe off the rust-prevention oil that was applied to the hydraulic oil cylinders' piston rods.
2. Add fuel, oil and grease to all parts.

Cranking

IMPORTANT: When the engine is being used for the first time or after a long period of storage, perform the cranking operation first in accordance with the procedure shown below in order to distribute lube oil to all of the parts. Using an engine which has been stored for a long period of time without the cranking procedure may result in engine seizure, since there will no longer be oil on the moving parts after storage.



1. Raise the safety bar.
2. Return the throttle lever in the low idling position.
3. Perform cranking.
 1. Insert the key into the starter switch.
 2. Turn the key to the START position and hold it there. The engine will begin turning.
 3. Continue cranking the engine for about 5 seconds, checking for abnormal sounds.
 4. Return the key to the OFF position. The engine will stop.



TROUBLESHOOTING

Symptoms that are not Malfunctions	134
If the Engine Overheats	135
If the Battery Goes Dead	136
After the Fuel Runs Out	137
If a Fuse Blows	138
If a Warning Lamp Flashes	140
Other Symptoms	142
To Lower the Lift Arms	144
Towing	145



The following symptoms are not malfunctions:

- The travel motor produces noise when stopped suddenly during high speed travel.
- The control valve produces noise if excessive force is applied to the working equipment and when the stroke end is reached.
- At times of combined operation of bucket and arm lowering, continuation of the combined operation after the bucket has reached the stroke end will result in the arm rising or stopping without going lower.

**! WARNING**

- **Do not open the engine hood when there is steam coming from the engine room. The steam or hot water may spurt out, resulting in burns.**
- **Do not remove the radiator cap or drain plugs when the coolant is hot. Stop the engine, let the engine and radiator cool and loosen the radiator cap or drain plugs slowly.**
- **Stop the engine and allow the machine to cool down before performing inspection and maintenance.**

The following symptoms indicate overheating:

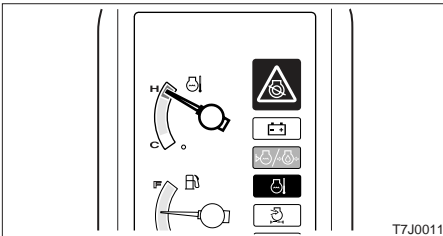

- An alarm is sounded and the coolant temperature warning lamp, engine emergency lamp flashes.
When the engine oil pressure/coolant level warning lamp is flashing simultaneously, the coolant level is low.
- The water temperature gauge shows the red zone.
- The engine slows down and the power decreases.
- Steam comes from the engine room.

Procedure

1. Park the machine in a safe place.
2. Inspect whether the engine oil pressure/coolant level warning lamp is flashing or if there is steam coming out when the engine hood is closed.
3. If there is steam, stop the engine immediately and contact a Gehl sales or service outlet for repairs.
If the engine oil pressure/coolant level warning lamp is off, run the engine at low idle and let the water temperature decrease.
4. Once the water temperature gauge drops to the green zone, stop the engine.
5. Once the engine is cool, perform the following inspections and procedures:
 - Fan belt slack Adjust.
Refer to page 109.
 - Coolant level Add.
Refer to page 102.
 - Water leakage Repair.
 - Radiator fins Clean.
Refer to page 117.
 - Sediment in cooling system Clean.
Refer to page 120.

If the problem persists after the above procedures are taken, contact a Gehl sales or service outlet for repairs.



The following symptoms indicate that the battery is dead:

- The starter motor does not turn or turns weakly, and the engine does not start.
- The horn is weak.

Procedure

Use jumper cables and start the engine using the rescue vehicle's battery.

WARNING

- Use jumper cables only in the recommended manner. Improper use of jumper cables can result in battery explosion or unexpected machine motion.
 - Do not let the problem vehicle and rescue vehicle touch each other.
 - Do not let the “+” and “-” clips of the jumper cables touch each other.
 - Connect the jumper cables to the “+” terminals first, and disconnect them from the “-” terminals (ground) first.
 - Connect the final clip of the jumper cable to a point as far away from the battery as possible.
- Use safety glasses when using jumper cables to start the machine.

IMPORTANT: Use jumper cables and clips of a size suited to the battery's capacity. Do not use damaged or corroded jumper cables and clips.

IMPORTANT: The rescue vehicle's battery must have the same capacity as the problem vehicle's battery.

IMPORTANT: Connect the clips securely.

Connecting the jumper cables

IMPORTANT: Set the starter keys of both the rescue vehicle and problem vehicle to the OFF position.

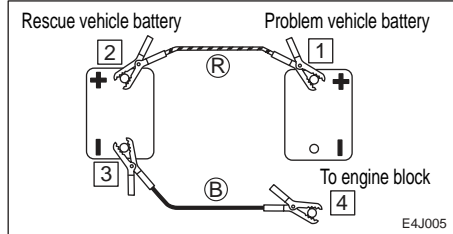

1. Connect the clip of jumper cable (R) to the problem vehicle's “+” terminal.
2. Connect the other clip of jumper cable (R) to the rescue vehicle's “+” terminal.
3. Connect the clip of jumper cable (B) to the rescue vehicle's “-” terminal.
4. Connect the other clip of jumper cable (B) to the problem vehicle's engine block. Connect the clip as far from the battery as possible.

Starting the engine

1. Check that the clips are securely connected to the terminals.
2. Start the rescue vehicle's engine and run it at high speed.
3. Start the problem vehicle's engine.

**Disconnecting the jumper cables**

Once the engine starts, disconnect the jumper cables following the connection procedure in reverse order.

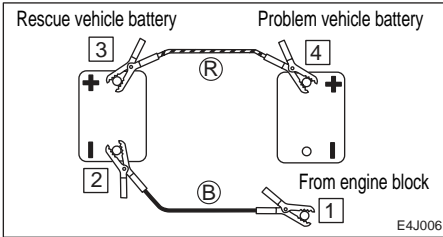

1. Disconnect the clip of jumper cable (B) from the problem vehicle's engine block.
2. Disconnect the other clip of jumper cable (B) from the rescue vehicle's "-" terminal.
3. Disconnect the clip of jumper cable (R) from the rescue vehicle's "+" terminal.
4. Disconnect the other clip of jumper cable (R) from the problem vehicle's "+" terminal.

Recharging

Have a Gehl sales or service outlet recharge batteries that have gone dead.

Bleeding the Air from the Fuel System

1. Add fuel.

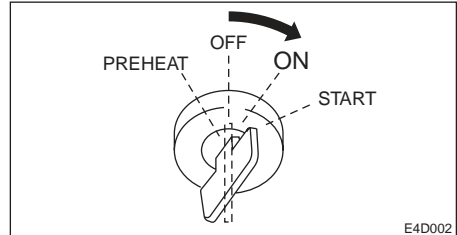

2. Turn the starter key to the ON position and hold it there for about 20 seconds. The automatic air bleeder bleeds the air from the fuel system.

Supplement: Air in the fuel system can make it difficult to start the engine and cause engine problems. Also bleed the air when the fuel tank is emptied or air in the fuel system.

**If a Fuse Blows**

If a light does not turn on or the electric system does not operate, a fuse may be blown. Inspect the fuses.

Inspecting and Replacing the Fuse**⚠ WARNING**

If the fuse blows as soon as it is replaced, there is a problem with the electric system. Continued use may lead to fire. Consult a Gehl sales or service outlet.

1. Turn the starter key to the OFF position and stop the engine.

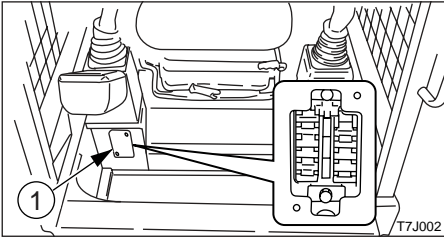

2. Open the fuse box cover (1).
3. Inspect for any blown fuses.

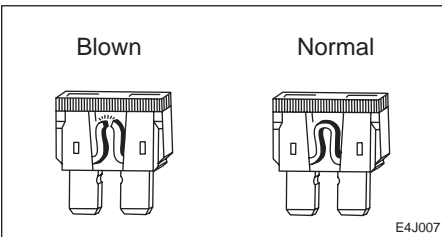

4. If a fuse is blown, replace it with a spare fuse of the same capacity.

Fuse Layout and Circuits Protected

Capacity	Protected circuit	Capacity	Protected circuit
30A	External power socket (option) Heater (option)		
20A	Tail light	20A	Reserve
20A	Front light	20A	Instrument panel Feed pump
30A	Arm float, Lever lock Auxiliary	10A	Safety relay Generator
10A	Rear wiper (option)	30A	Engine stop-solenoid
10A	Front wiper (option)	20A	Horn Interior light (option)

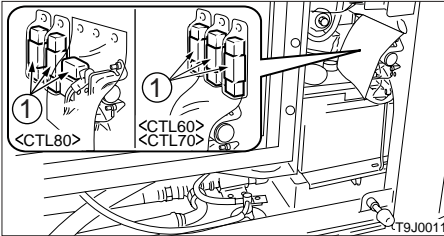



**Inspecting the Fusible Link**

If the power is not switched on after turning the starter switch to the ON position, the cartridge type fusible links (1) might be blown open. Open the rear door and inspect. If the fusible link is blown, please contact your dealer.

Supplement: A fusible link is a large piece of fuse wiring which is mounted in a circuit which carries a large electrical current. Link a regular fuse, the fusible link protects the electrical parts and wiring from damage due to abnormally large currents.

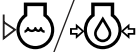
**If a Warning Lamp Flashes**

If an alarm is sounded or a warning lamp starts flashing during operation, park the machine in a safe place and perform the procedures described below.

Warning lamp	Lamp name	Procedure
 T7B007	Engine emergency lamp	<p>A problem has occurred in the engine lubrication system or the coolant water temperature has risen irregularly.</p> <ul style="list-style-type: none"> • When there is a problem in the engine lubrication system or coolant level, the engine oil pressure/coolant level warning lamp flashes simultaneously. • When the coolant temperature has risen irregularly, the coolant temperature warning lamp flashes simultaneously. <p>For the procedures, refer to the respective warning lamps below.</p>
 L3J004	Engine oil pressure/coolant level warning lamp	<p>Inspect the engine oil level or coolant level. If the lamp is flashing even though the level is normal or if it continues flashing after oil or coolant are added, consult a Gehl sales or service outlet.</p> <p>Refer to page 102 or 103 “Inspecting and replenishing the coolant” or “Inspecting and Replenishing the Engine Oil”.</p>
 C4B012	Coolant temperature warning lamp	<p>The coolant temperature has risen irregularly and the engine is overheating.</p> <p>Refer to page 135 “If the Engine Overheats”.</p>
 OSO080	Battery charge warning lamp	<p>There is a problem with the fan belt or charger. Inspect the fan belt for slack or breakage and adjust as necessary. If the lamp continues flashing after maintenance, there is a problem with the charger. Consult a Gehl sales or service outlet.</p> <p>Refer to page 109 “Inspecting and Adjusting the Fan Belt”.</p>
 G4B010	Air cleaner warning lamp	<p>The air cleaner filter is clogged.</p>

**If a Warning Lamp Flashes**

Warning lamp	Lamp name	Procedure
 T7B008	Line filter warning lamp	Hydraulic oil line filter is clogged. Stop the engine and replace the filter. Continuing to operate the machine while the lamp is lit could damage the line filter and hydraulic equipment. Replace the filter immediately should the lamp flashes. Refer to page 110 "Replacing the Line Filter".



For symptoms not included on the table below or if the problem persists after the proper procedures have been taken, consult a Gehl sales or service outlet.

Symptoms	Main cause	Procedure
Left and right control levers do not move smoothly	<ul style="list-style-type: none">● Insufficient grease on left and right control levers	<ul style="list-style-type: none">● Add grease. Refer to page 128.
Pedal do not move smoothly	<ul style="list-style-type: none">● Insufficient grease on pedal	<ul style="list-style-type: none">● Add grease. Refer to page 128.
Lift arms, bucket, auxiliary hydraulics or traveling operation not possible	<ul style="list-style-type: none">● Safety bar is raised● Fuse is blown	<ul style="list-style-type: none">● Lower the safety bar. Refer to page 50.● Replace the fuse. Refer to page 138.
Scooping or lifting force is insufficient	<ul style="list-style-type: none">● Insufficient hydraulic oil level● Hydraulic oil is not heated● Air cleaner is clogged● Hydraulic oil is not of suitable type	<ul style="list-style-type: none">● Replenish to the prescribed level. Refer to page 105.● Perform the warm-up procedure. Refer to page 63.● Clean the air cleaner.● Replace the hydraulic oil. Refer to page 122.
Traveling is not possible or not smooth	<ul style="list-style-type: none">● Stones or foreign objects are stuck	<ul style="list-style-type: none">● Remove the foreign object.
Machine does not travel straight forward	<ul style="list-style-type: none">● Stones or foreign objects are stuck	<ul style="list-style-type: none">● Remove the foreign object.
Operation is not possible with the various switches	<ul style="list-style-type: none">● Fuse is blown● Safety bar is raised	<ul style="list-style-type: none">● Replace the fuse. Refer to page 138.● Lower the safety bar. Refer to page 50.
Travel speed cannot be changed	<ul style="list-style-type: none">● Fuse is blown	<ul style="list-style-type: none">● Replace the fuse. Refer to page 138.



Symptoms	Main cause	Procedure
Hydraulic oil temperature is too high	<ul style="list-style-type: none">● Insufficient hydraulic oil	<ul style="list-style-type: none">● Replenish to the prescribed level. Refer to page 105.
Starter motor turns but engine does not start	<ul style="list-style-type: none">● Insufficient fuel● Air in fuel system● Water in fuel system	<ul style="list-style-type: none">● Add fuel. Refer to page 104.● Bleed the air. Refer to page 137.● Drain the water. Refer to page 112.
Crawlers slip off	<ul style="list-style-type: none">● Crawlers are too loose	<ul style="list-style-type: none">● Adjust the tension. Refer to page 111.
Engine exhaust is white or bluish	<ul style="list-style-type: none">● Excessive engine oil● Insufficient fuel	<ul style="list-style-type: none">● Adjust to the prescribed level. Refer to page 103.● Replace the fuel.
Engine exhaust is occasionally black	<ul style="list-style-type: none">● Air cleaner is clogged	<ul style="list-style-type: none">● Clean the air cleaner.
Irregular noise is produced from the engine (combustion or mechanical noise)	<ul style="list-style-type: none">● Low quality fuel is being used● Engine is overheating● Damage in muffler	<ul style="list-style-type: none">● Replace the fuel.● If the Engine Overheats Refer to page 135.● Replace the muffler. (Request at a sales or service outlet.)



If the lift arms must be lowered to the ground while the engine is stopped, use the following procedure to do so.

This operation is dangerous and requires experience. Have it performed by a Gehl sales or service outlet.

Procedure

⚠ WARNING

- Do not approach in the area of the ground where the lift arms are to be lowered. You may be hit by dirt falling out of the bucket or the lift arms as it drops.
- Turn the port relief valve's set screw slowly so that the lift arms lowers slowly. Do not turn the screw more than the specified amount.

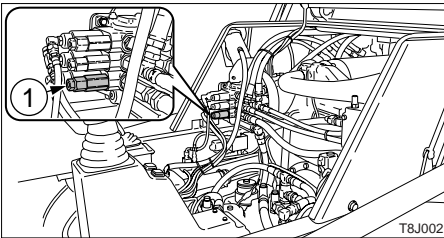

1. Tilt up the ROPS.

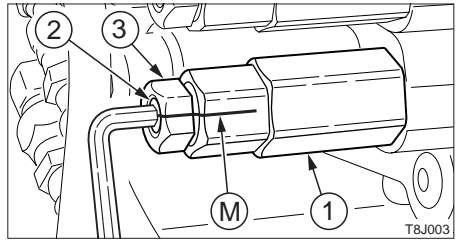

2. Put mark (M) on the plug of the port relief valve (1) and set screw (2).
3. Gripping the set screw (2) with a hexagonal wrench so that it does not turn together with the lock nut (3), loosen the lock nut (3).
4. Turn the set screw (2) slowly 1 turn to lower the lift arms.
5. Check for safety and machine stability.
6. Turn the set screw (2) back to its original position.
7. Gripping the set screw (2) with a hexagonal wrench so that it does not turn together with the lock nut (3), tighten the lock nut (3).
Tightening torque:
 $31.4 \pm 2.9 \text{ N}\cdot\text{m}$ ($23.1 \pm 2.1 \text{ ft}\cdot\text{lb.}$)
8. Lower the ROPS.

**⚠ WARNING**

When towing, selecting the wrong wire rope, inspecting improperly, or towing in the wrong way could lead to accidents resulting in serious injury or death.

- The wire rope breaking or coming detached could be extremely dangerous. Use a wire rope suited for the required towing force.
- Do not use a wire rope that is kinked, twisted or otherwise damaged.
- Do not apply strong loads abruptly to the wire rope.
- Use safety gloves when handling the wire rope.
- Make sure there is an operator on the machine being towed as well as on the machine that is towing.
- Never tow on slopes.
- Do not let anyone near the wire rope while towing.

1. Attach the wire ropes (2) to the hooks (1) as shown in the figure.
2. Make the wire rope horizontal and line up straight with the travel frame.
3. Move the machine to tauten the wire rope.
4. Move the machine slowly and tow.

Towing the Machine

Use the procedure described below to tow light weight objects or the machine itself if it should get stuck in the mud and not be able to get out on its own.

IMPORTANT: Be sure to follow all the steps below closely when towing. Failure to heed even one of the steps may cause damage to the hooks (1).

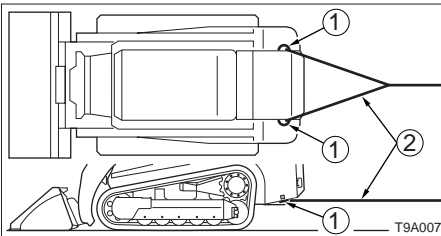

- Maximum pulling force:
35000 N (3570 kgf) or less



SPECIFICATIONS

Main Specifications	148
Machine Dimensions	152
Operating Range	154

**CTL60****MASS**

Machine mass kg (lb.) (not including operator)	Rubber crawlers	3325 (7330)
---	-----------------	-------------

PERFORMANCE

Bucket capacity m ³ (cu.ft.) (standard bucket)	Heaped	0.351 (12.4)	
	Struck	0.260 (9.18)	
Travel speed km/h (mph)	Rubber crawlers	1st	7.3 (4.54)
		2nd	10.4 (6.46)
Gradeability (degrees)		30	
Ground pressure kPa (psi)	Rubber crawlers	33.3 (4.83)	
Noise level <For EU> dB (A)	Sound-power level	L _{WA} 105	
	Sound-pressure level	L _{pA} 88	

ENGINE

Manufacturer and model		Yanmar 4TNV98-YTBL
Rated output	kW / min ⁻¹ (hp / rpm)	49.2 / 2450 (66.9 / 2450)
Displacement	ml (cu.in.)	3319 (202.5)
Starter	V - kW	12 - 3.0
Alternator	V - kW	12 - 0.48
Battery	V - A·h	12 - 80

**CTL70****MASS**

Machine mass kg (lb.) (not including operator)	Rubber crawlers	4275 (9425)
---	-----------------	-------------

PERFORMANCE

Bucket capacity m ³ (cu.ft.) (standard bucket)	Heaped	0.458 (16.17)
	Struck	0.335 (11.8)

Travel speed km/h (mph)	Rubber crawlers	1st	7.3 (4.54)
		2nd	10.4 (6.46)

Gradeability (degrees)	30
------------------------	----

Ground pressure kPa (psi)	Rubber crawlers	28.2 (4.1)
---------------------------	-----------------	------------

Noise level <For EU>	dB (A)	Sound-power level	L _{WA} 105
		Sound-pressure level	L _{pA} 92

ENGINE

Manufacturer and model	ISUZU 4JG1T	
Rated output	kW / min ⁻¹ (hp / rpm)	60.3/ 2500 (80.9 / 2500)
Displacement	ml (cu.in.)	3059 (186.7)
Starter	V - kW	12 - 2.2
Alternator	V - kW	12 - 0.6
Battery	V - A·h	12 - 80

**CTL80**

MASS			
Machine mass kg (lb.) (not including operator)	Rubber crawlers	4775 (10525)	
PERFORMANCE			
Bucket capacity m ³ (cu.ft.) (standard bucket)	Heaped	0.579 (20.45)	
	Struck	0.426 (15.04)	
Travel speed km/h (mph)	Rubber crawlers	1st	8.1 (5.03)
		2nd	11.1 (6.9)
Gradeability (degrees)		30	
Ground pressure kPa (psi)	Rubber crawlers	29.7 (4.31)	
Noise level <For EU> dB (A)	Sound-power level	L _{WA} 106	
	Sound-pressure level	L _{pA} 86	
ENGINE			
Manufacturer and model		Yanmar 4TNV106T-XTBL	
Rated output	kW / min ⁻¹ (hp / rpm)	72.0 / 2200 (96.5 / 2200)	
Displacement	ml (cu.in.)	4412 (269.2)	
Starter	V - kW	12 - 3.0	
Alternator	V - kW	12 - 0.72	
Battery	V - A·h	12 - 92	

MEMO

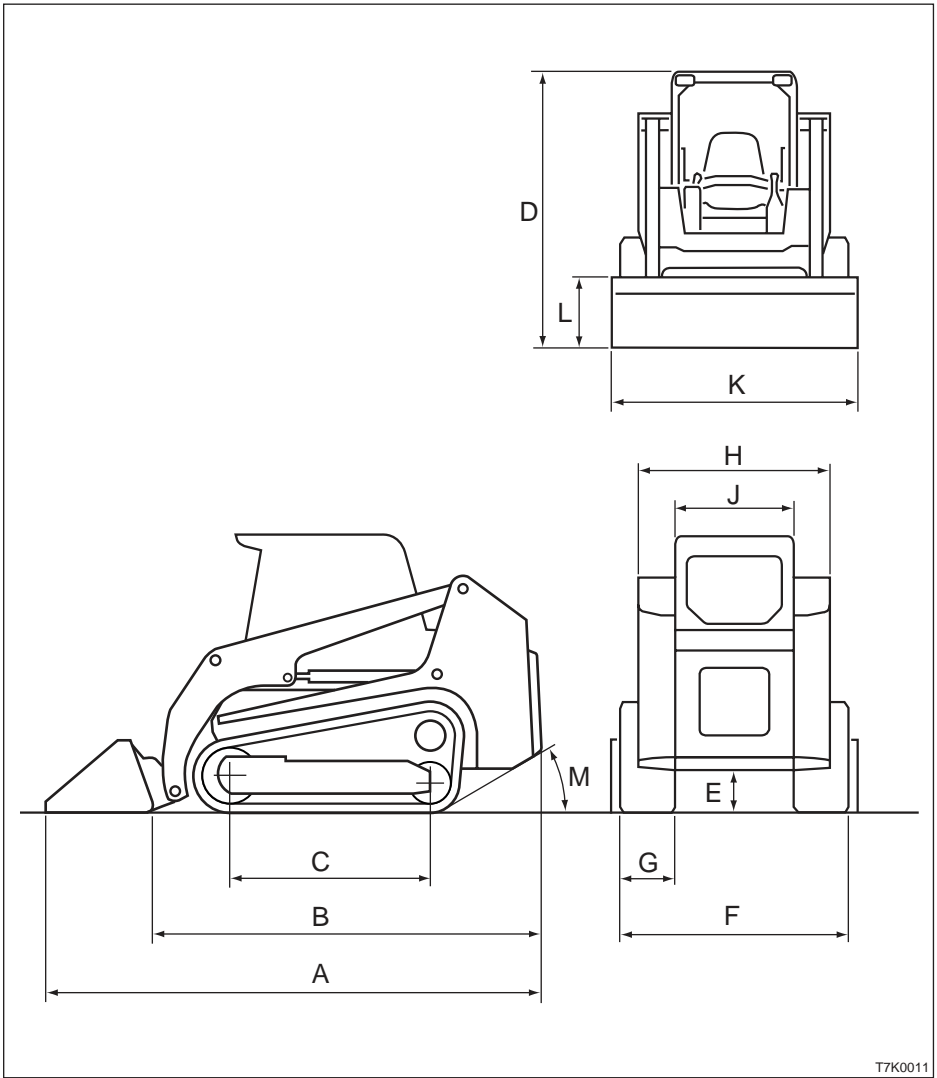

T7K0011



Machine Dimensions

Units: mm (inches)

	CTL60	CTL70	CTL80
	Standard Bucket		
	Rubber Crawlers		
A	3430 (135.1)	3710 (146.0)	3985 (156.9)
B	2740 (107.8)	2950 (116.1)	3135 (123.5)
C	1390 (54.7)	1495 (58.9)	1595 (62.9)
D	2130 (83.9)	2170 (85.4)	2215 (87.2)
E	310 (12.1)	325 (12.8)	345 (13.5)
F	1580 (62.2)	1770 (69.7)	1860 (73.2)
G	320 (12.6)	450 (17.7)	←
H	1430 (56.3)	1500 (59.1)	1570 (61.8)
J	980 (38.6)	←	←
K	1675 (66.0)	1880 (74.0)	1960 (77.2)
L	510 (20.0)	535 (21.1)	580 (22.8)
M	30°	←	←

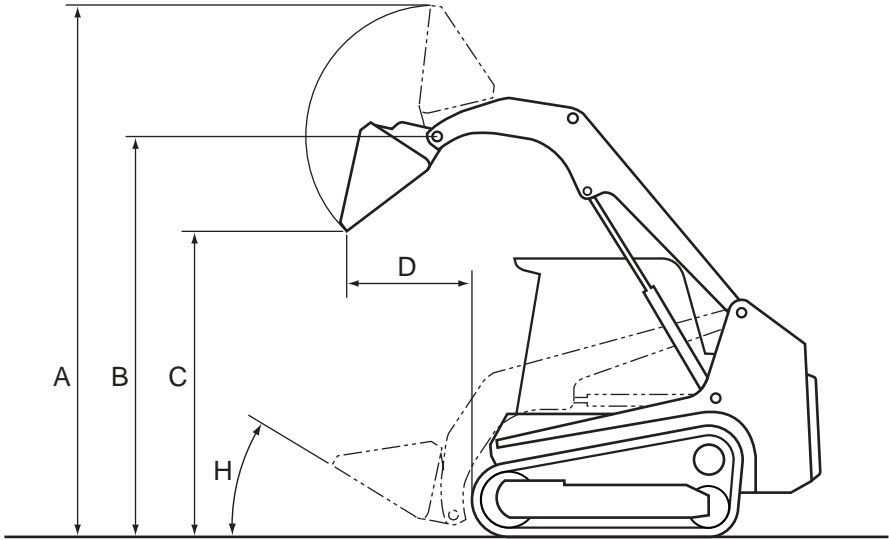
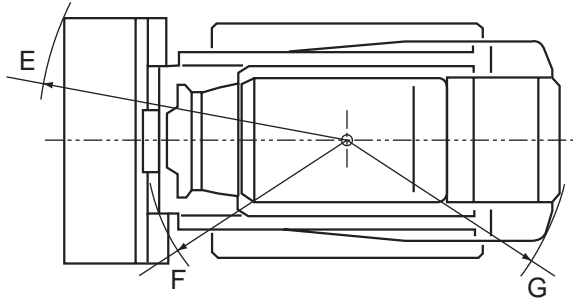

T7K0021



SPECIFICATIONS

Operating Range

Units: mm (inches)

	CTL60	CTL70	CTL80
	Standard Bucket		
	Rubber Crawlers		
A	3905 (153.8)	4080 (160.7)	4245 (167.2)
B	3030 (119.3)	3120 (122.9)	3205 (126.1)
C	2370 (93.4)	2405 (94.8)	2430 (95.7)
D	730 (28.8)	875 (34.4)	985 (38.8)
E	2080 (82.0)	2295 (90.4)	2435 (95.8)
F	1375 (54.1)	1500 (59.1)	1560 (61.4)
G	1590 (62.7)	1670 (65.7)	1755 (69.1)
H	30°	31°	←



OPTIONS

General Precautions	158
----------------------------------	------------

**Precautions on Safety** **WARNING**

Heed the following when removing or installing an attachment or option:

- Consult with a Gehl dealer before installing optional attachments.
 - Do not use attachments that have not been approved by Gehl or a Gehl dealer. Doing so may compromise safety or adversely affect the machine's operation or service life.
 - Gehl will not be held responsible for any injuries, accidents or damage to products caused by the use of a non-approved attachment.
 - Choose a flat, hard surface to perform the operations. Also make sure there is enough light and good ventilation.
 - Clean the area, remove any articles that may get in the way or be dangerous, and remove any spilled oil or grease.
 - When removing or installing the hoe attachment, place it in a stable position so that it does not tip over.
 - Due to the risk of loads falling and/or hitting people, do not allow unauthorized personnel in the work area.
 - Use the crane to carry heavy objects (25 kg (55 lb.) or greater).
 - When removing heavy parts, be sure to prop them up before removing them. When lifting them with a crane, be careful to balance them properly.
 - Operating with loads suspended with the crane is dangerous. Place loads on a stand and check for safety.
 - When attaching the attachments, failure to follow proper procedures could result in serious damage. Consult with a Gehl dealer beforehand.
-

Precautions on Installing Attachments

After replacing optional attachments or other special attachments, test-run them, then inspect the hydraulic oil level and add oil if necessary.

In addition, consult with a Gehl dealer for details of removal and installation procedures.

**Precautions on Operating Attachments****! WARNING**

Long attachments reduce machine stability. When traveling down steep slopes or turning on slopes, the machine may lose its balance and tip over.

The following operations are particularly dangerous. Do not perform them.

- **Traveling down slopes with the attachment lifted**
- **Traveling across slopes**
- **Turning on slope**

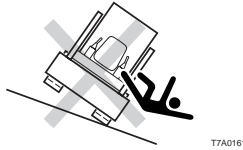
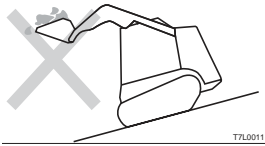

- **When heavy attachments are installed, the overrun (the distance from where the operation to stop traveling is performed until traveling stops completely) increases and mistakes in judgment may result in the attachment hitting surrounding objects. Allow for plenty of room between the attachment and obstacles. In addition, the natural drop (the gradual dropping of the attachment under its own weight when it is stopped in midair) also increases when heavy attachments are installed.**
-



INDEX



A

Accessories 52

After Cold Weather is Over 79

After First 50 Hours (New Machines Only) 107

After First 500 Hours (New Machines Only) 116

After starting the engine 15

After the Fuel Runs Out 137

Always clean the machine 26

Always keep the machine clean 12

Anti-explosive lighting 25

Attach a "DO NOT OPERATE" tag 25

Auxiliary Hydraulic Lines 55

Auxiliary Hydraulic Switches 49

Auxiliary Pedal (If equipped) 53

Avoid battery hazards 30

Avoid fire and explosion hazards 10

Avoid overloading and off-center loads 20

B

Be careful not to get crushed or cut 11

Be careful with fluids under pressure 29

Be careful with grease under pressure 29

Be careful with hot and pressurized components 28

Be careful with hot cooling systems 29

Before Starting Operation 60

Before Starting the Engine 61

Bleeding the Air from the Fuel System 137

C

Caution against the falling of an unstable load 19

Cautions 81

Cautions after Completing Operations 79

Cautions on Maintenance 88

Cautions on Operating 72

Cautions on tilting up the canopy 27

Cautions on Towing 22

Cautions on Transporting 86

Cautions on traveling and turning 17

Cautions on traveling on slopes 18

Cautions on Traveling on Slopes 74

Check for safety in the surrounding area before starting 16

Check the strength of the bridge 12

Checks after maintenance 31

Cleaning the Engine Cooling System 120

Cleaning the Radiator and Oil Cooler Fins 117

Cleaning the Water Separator (CTL 60 / CTL80) 114

Clear the area of other persons before starting the machine 14

Controls 35

Crush Hazard FOPS Limitations 9

D

Daily Inspection 58

Daily Inspection (Every 10 Hours) 102

Danger of flying objects 22

Disconnect the battery 30

Disposing of wastes 31

Do not allow unauthorized personnel in the work area 25

Do not carry the bucket over the heads of people 19

Do not drive into materials at high speed 19

Do not enter soft ground 21

Do not permit riders on the machine 16

Do not suddenly stop or lower the working equipment 20

Doors and Covers 38

Draining the Fuel Tank 113

**E**

Emergency Exit	13
Emergency Exit	39
Engine Hood	38
Ensure good visibility	16
Every 100 Hours	114
Every 1000 Hours	120
Every 2000 Hours	125
Every 250 Hours	115
Every 50 Hours	111
Every 500 Hours	117
Exhaust fumes from the engine can kill	10
Expendables	91
External Power Socket (Option)	55

F

Float Switch	46
Fuel and Lubricant Chart	90
Fuel Filler Cap	41

G

General	88
General Precautions	8
General Precautions	158

H

Handling asbestos dust	10
Handling in Cold Weather	79
Handling of hoses	28
Handling Rubber Crawlers	80
Have a Takeuchi service agent repair welding cracks or other damage	31

Heater (Option)	52
High Flow Hydraulic System (If equipped)	54
Horn Switch	46

I

If a Fuse Blows	138
If a Warning Lamp Flashes	140
If the Battery Goes Dead	136
If the Engine Overheats	135
Important Parts	94
In cold weather	15
Index	161
Indicators	45
Inspecting and Adjusting the Crawler Tension	111
Inspecting and Adjusting the Engine Valve Clearance	124
Inspecting and Adjusting the Fan Belt	109
Inspecting and Adjusting the Fan Belt	115
Inspecting and Replacing the Fuse	138
Inspecting and Replenishing the Coolant	102
Inspecting and Replenishing the Engine Oil	103
Inspecting and Replenishing the Windshield Washer Fluid	128
Inspecting by Opening the Engine Hood and Rear Door	100
Inspecting by Walking Around the Machine	101
Inspecting the Battery Fluid Level and Replenishing	112
Inspecting the Engine Fuel Injection Pressure and Spray Condition	124
Inspecting the Engine Fuel Injection Timing	125
Inspecting the Engine Fuel Injection Valve	125
Inspecting the Fuel Level	104
Inspecting the Fusible Link	139
Inspecting the Hydraulic Oil Level and Replenishing	105
Inspecting the Rubber Crawlers	130



Inspecting the Water Separator	103
Inspecting While Sitting in the Operator's Seat	101
Inspection After Warm-up	64
Inspection and Checks After Stopping the Engine	78
Instrument Panel	44
Interior Light (Option)	55
Introduction	2

K

Keep a safe distance from electrical power lines	20
Keep your body inside the operator's cab	16
Know the working area	12

L

Left Control Lever	51
Lever Pattern	62
Levers and Pedals	50
Lift Arm Stop	40
Light Switches	49
Load and unload the machine safely	24
Loaders are NOT designed for lifting loads	22
Loading and Unloading	84
Long-term Storage	130
Lubricating the Levers	128
Lubricating the Working Equipment	106

M

Machine Description	3
Machine Dimensions	152
Machine Operation	62
Main Specifications	148
Maintain three point contact when mounting and dismounting	14

Maintenance	87
Maintenance Chart	96
Maintenance Description	88
Maintenance Log	98
Maintenance Precautions	25
Manual storage	2
Meters	45
Mounting and Dismounting	58

N

Names of Components	36
Never modify the machine	11
Never remove safety equipment	9

O

Observe all safety rules	8
Operate on snow or ice with extra care	19
Operate the machine only from the operator's seat	16
Operating Precautions	16
Operating Procedures	70
Operating Range	154
Operating the Auxiliary Hydraulics	69
Operating the Left Control Lever	65
Operating the Right Control Lever	68
Operation	59
Operations Possible with this Machine	76
Options	157
Other Symptoms	142

P

Park safely	23
Parking	78
Parking the Machine	78



Perform inspection and maintenance daily	13
Place heavy objects in a stable position	27
Precautions on Installing Attachments	158
Precautions on Operating Attachments	159
Precautions on Safety	158
Precautions when passing through tunnels or by high walls	21
Prepare the work area	26
Preparing for Cold Weather	79
Preparing Precautions	12
Prohibited Actions	80
Prohibited Operations	70
Provide a fire extinguisher and first aid kit	8

R

Rear Door	39
Release all pressure before working on the hydraulic system	29
Replace important safety parts periodically	25
Replacing the Air Cleaner Elements	121
Replacing the Bucket or Attachment	126
Replacing the Engine Oil and Oil Filter	108
Replacing the Engine Oil and Oil Filter	115
Replacing the Feed Pump Filter (CTL70)	118
Replacing the Fuel Filter	117
Replacing the Hydraulic Oil and Cleaning the Suction Strainer	122
Replacing the Hydraulic Oil Return Filter	107
Replacing the Hydraulic Oil Return Filter	119
Replacing the Line Filter	110
Replacing the Line Filter	119
Replacing the Travel Motor Gear Oil	116
Replacing the Travel Motor Gear Oil	124
Retightening the Engine Cylinder Head Bolts	124
Right Control Lever	50

S

Safety	7
Safety Bar	50
Safety signs	31
Safety Signs (Decals)	32
Seat	42
Seat and Seat Belt	42
Seat Belt	43
Secure the rear door when opened	27
Securely block the machine or any component that may fall	27
Securely block the raised lift arms	27
Securing the Machine	85
Serial numbers	2
Service Data	90
Side Window	40
Specifications	147
Start the engine from the operator's seat	14
Starter Key	38
Starter Switch	46
Starting and Stopping the Engine	59
Starting Precautions	14
Starting the Engine	60
Starting with jumper cables	15
Stay clear of moving parts	26
Stop the engine before performing maintenance	26
Stopping Precautions	23
Stopping the Engine	61
Switches	48
Symptoms that are not Malfunctions	134

T

Throttle Lever	50
Tightening Torques	93
Tilting Up the ROPS	129



To Lower the Lift Arms	144
Tools	92
Towing	145
Transport	83
Transport the machine safely	24
Transporting Precautions	24
Travel in narrow or congested places	21
Travel Speed Switch	48
Troubleshooting	133

U

Use a signal person and flagman	9
Use caution when floating the lift arms	18
Use caution when fueling	28
Use the correct tools	25
Using optional products	11

W

Walk-Around Inspection	58
Walk-Around Inspection	100
Warming Up the Engine	61
Warming Up the Hydraulics	63
Warning Lamps	44
Watch out for hazardous working conditions	21
Wear appropriate clothing and personal protective equipment	8
When Required	126
Wiper Switches (Option)	51

GEHL CONSTRUCTION WARRANTY

GEHL CONSTRUCTION DIVISION of the **GEHL COMPANY**, hereinafter referred to as Gehl, warrants new Gehl construction equipment to the Original Retail Purchaser to be free from defects in material and workmanship for a period of twelve (12) months from the Warranty Start Date, except as set forth below.

GEHL CONSTRUCTION WARRANTY SERVICE INCLUDES:

Genuine Gehl parts and labor costs required to repair or replace equipment at the selling dealer's business location.

GEHL MAKES NO REPRESENTATIONS OR WARRANTIES OF ANY KIND, EXPRESS OR IMPLIED (INCLUDING THE IMPLIED WARRANTIES OF MERCHANTABILITY AND FITNESS FOR PARTICULAR PURPOSE), EXCEPT AS EXPRESSLY STATED IN THIS WARRANTY STATEMENT.

GEHL WARRANTY SERVICE DOES NOT INCLUDE:

1. Transportation to selling dealer's business location or, at the option of the Original Retail Purchaser, the cost of a service call.
2. Used equipment.
3. Components covered by their own non-Gehl warranties, such as tires, trade accessories and engines.
4. Normal maintenance service and expendable, high wear items.
5. Repairs or adjustments caused by: improper use; failure to follow recommended maintenance procedures; use of unauthorized attachments; accident or other casualty.
6. Liability for incidental or consequential damages of any type, including, but not limited to lost profits or expenses of acquiring replacement equipment.

No agent, employee or representative of Gehl has any authority to bind Gehl to any warranty except as specifically set forth herein. Any of these limitations excluded by local law shall be deemed deleted from this warranty; all other terms will continue to apply.



WARNING



**THIS OPERATOR'S MANUAL IS
PROVIDED FOR OPERATOR USE**

DO NOT REMOVE FROM THIS MACHINE

Do not start, operate or work on this machine until you carefully read and thoroughly understand the contents of this operator's manual.

Failure to follow safety, operating and maintenance instructions can result in serious injury to the operator or bystanders, poor operation, and costly breakdowns.

If you have any questions on proper operation, adjustment or maintenance of this machine, contact your dealer or the Gehl Company Service Department before starting or continuing operation.

California Proposition 65 Warning

Diesel engine exhaust and some of its constituents are known to the State of California to cause cancer and birth defects or other reproductive harm.

Battery posts, terminals and related accessories contain lead and lead compounds, chemicals known to the State of California to cause cancer and birth defects or other reproductive harm. Wash hands after handling battery.

GEHL®

Gehl Company 143 Water Street, P.O. Box 179, West Bend, WI 53095-0179 U.S.A.
www.gehl.com