

GEHL

Form No.
917299
Revision E
09/10

**CTL55
CTL65
CTL75
CTL85
Compact
Track Loader**

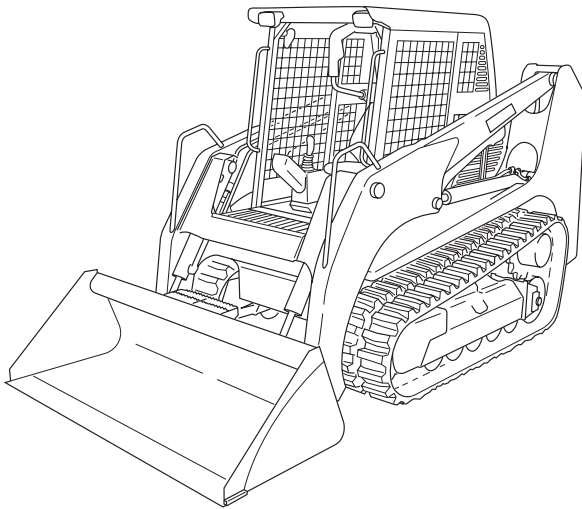

OPERATOR'S MANUAL



SAFETY ALERT SYMBOL

This symbol means **Attention! Be Alert! Your Safety Is Involved.** The message that follows this symbol contains important safety information. Read and understand the message to avoid personal injury or death.

- It is the owner's or employer's responsibility to fully instruct each operator in the proper and safe operation of all equipment. All persons using this machine should thoroughly familiarize themselves with the following sections.
- All operators must be instructed on the proper functions of the loader before running the machine.
- Learn and practice correct use of the machine controls in a safe, clear area before operating this machine on a job site.

CAUTION



Improper operation, inspection and maintenance of this machine can cause injury or death.
Read and understand this manual before performing any operation, inspection or maintenance on this machine.

- Always store this manual where it is ready available, preferably on the machine itself. If it is lost or damaged, immediately order a new one from your Gehl dealer.
When transferring ownership of this machine, be sure to provide this manual to the new owner.
- Gehl Company supplies machines complying with the local regulations and standards. If your machine has been purchased in another country or from a person or company of another country, it may not have the safety devices or meet the safety standards required for use in your country. If you have any question about whether your machine complies with the regulations and standards of your country, contact a Gehl dealer.
- Please note that the contents and diagrams included in this manual may not match your machine exactly.

It is your responsibility to observe all pertinent laws and regulations and to follow the manufacturer's instructions on machine operation, inspection and maintenance.

Virtually all accidents occur as the result of a failure to observe basic safety rules and precautions. An accident can often be avoided by recognizing potentially hazardous situations beforehand. Read and understand all of the safety messages, which explain how to prevent these accidents from occurring. Do not operate the machine until you are sure that you have gained a proper understanding of its operation, inspection and maintenance.

■ SIGNAL WORDS

Safety messages appearing in this manual and on machine decals are identified by the words "DANGER", "WARNING" and "CAUTION". These signal words mean the following:

 DANGER
The word "DANGER" indicates an imminently hazardous situation, which, if not avoided, can result in serious injury or death.

 WARNING
The word "WARNING" indicates a potentially hazardous situation, which, if not avoided, could result in serious injury or death.

 CAUTION
The word "CAUTION" indicates a potentially hazardous situation, which, if not avoided, may result in injury.

IMPORTANT: The word "IMPORTANT" is used to alert operators and maintenance personnel about situations that can result in possible damage to the machine and its components.



It is impossible to foresee every possible circumstance that might involve a potential hazard. The warnings in this manual or on the machine can not cover all possible contingencies. You must exercise all due care and follow normal safety procedures when operating the machine to ensure that no damage occurs to the machine, its operators or other persons.

■ EXPLANATION OF GRAPHICAL SYMBOLS

Following is an explanation of symbols used in this manual.

 , X prohibition

 /  Lock

 /  Unlock

INTRODUCTION

Foreword

This manual describes operation, inspection and maintenance of the machine, as well as safety instructions to be heeded during these operations.

If you have any questions about the machine, please contact a Gehl dealer.

■ Manual storage

A compartment for storing this manual is provided at the position shown in the diagram below.

1. Insert the starter key and turn it counterclockwise to unlock the cover (1).
2. Open the cover (1).
3. After using the manual, place it in the plastic pouch and store it in the manual storage.

Type A

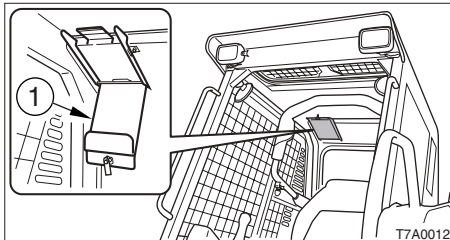

Type B

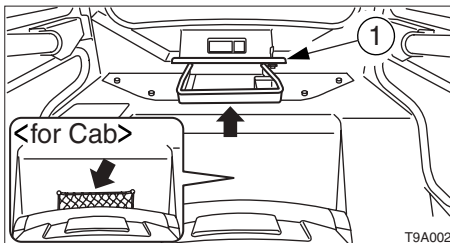

■ Serial numbers

Check the serial numbers of the machine and the engine and write them in the spaces provided below.

Machine number :

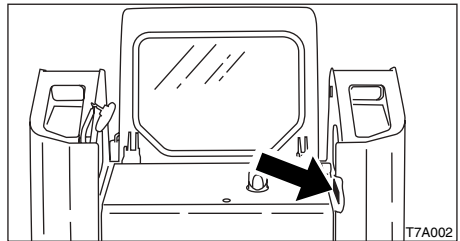

Engine number :

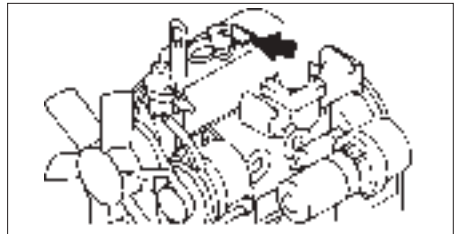

MACHINE DESCRIPTION

■ Front, rear, left and right

This manual refers the front, rear, left and right of the machine as seen when sitting in the operator's seat with the bucket visible to the front.

■ Designated operations

Use this machine primarily for the following operations:

- Carrying
- Leveling
- Loading

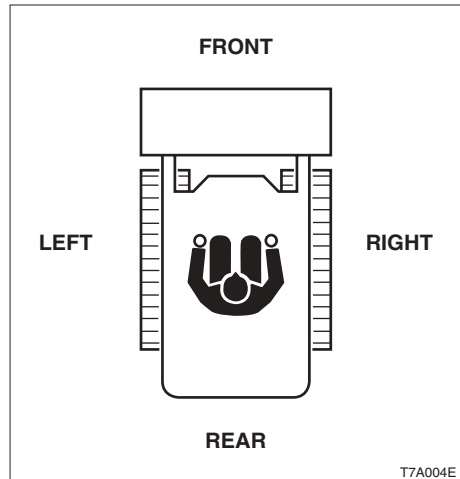

■ Features

- Hydrostatic drive system
- Roll Over / Falling Object Protective Structure (ROPS/FOPS), tilt-up ROPS
- Low engine noise and exhaust emissions
- Two-way auxiliary hydraulics
- Pilot-operated joystick controls









■ Break-in period

When the machine is new, follow the instructions below when operating the machine for the first 100 hours (as indicated on the hourmeter).

Using a new machine roughly without breaking it in will lead to quicker deterioration of machine performance and may shorten the machine's service life.

- Warm up the engine and hydraulic oil sufficiently.
- Avoid heavy loads and rapid operations. Operate with a load of about 80% of the maximum load.
- Do not start up, accelerate, change directions, or stop abruptly unless necessary.

CONTENTS

Introduction.....	2
Machine Description	3
 Safety	7
 Controls	39
 Operation.....	69
 Transport	95
 Maintenance	101
 Troubleshooting.....	155
 Specifications	169
 Options	179
 Index.....	193



SAFETY

General Precautions	8
Preparing Precautions	15
Starting Precautions.....	17
Operating Precautions	19
Stopping Precautions.....	26
Transporting Precautions	27
Maintenance Precautions.....	28
Safety Signs (Decals).....	35



SAFETY

General Precautions

Observe all safety rules

- Operation, inspection and maintenance of this machine must be performed only by trained and qualified persons.
- All rules, regulations, precautions and safety procedures must be understood and followed when performing operation, inspection and maintenance of this machine.
- Do not perform any operation, inspection and maintenance of this machine when under the adverse influence of alcohol, drugs, medication, fatigue, or insufficient sleep.

Wear appropriate clothing and personal protective equipment



- Do not wear loose clothing or any accessory that can catch on controls or in moving parts.
- Do not wear oily or fuel-stained clothing that can catch fire.
- Wear a hard hat, safety shoes, safety glasses, filter mask, heavy gloves, ear protection and other protective equipment as required by job conditions. Wear required appropriate equipment such as safety glasses and filter mask when using grinders, hammers or compressed air, because metal fragments or other objects can fly and cause serious injury.

- Use hearing protection when operating the machine. Loud prolonged noise can cause hearing impairment, even the total loss of hearing.

Operating temperature range

To maintain the performance of machine and to prevent it from early wear, observe the following operating conditions.

- Do not operate the machine if the ambient temperature is higher than +45°C (+113°F) or lower than -15°C (+5°F).
- If operated at an ambient temperature of higher than +45°C (+113°F), the engine may overheat and cause the engine oil to degrade.
- If operated at an ambient temperature of lower than -15°C (+5°F), the parts made of rubber such as gaskets may get hardened to cause an early wear or damage to the machine.
- If the machine is to be used outside the ambient temperature range described above, consult your sales or a service dealer.

Provide a fire extinguisher and first aid kit

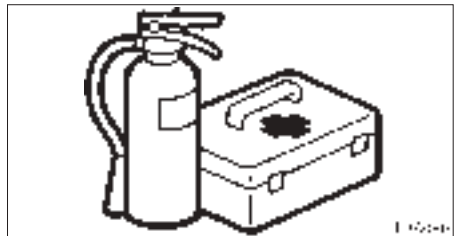

- Know where a fire extinguisher and first aid kit are located and understand how to use them.
- Know how to contact emergency assistance and first aid help.



Never remove safety equipment

- Make sure all protective guards, canopies, doors, etc., are in place and secure. Repair or replace damaged components before operating the machine.



- Know how to use the safety bar, seat belt and other safety equipment and use them properly.
- Never remove any safety equipment except for service. Keep all safety equipment in good operating condition.

Crush Hazard FOPS Limitations

Various classes and sizes of off-road equipment operate in a wide variety of applications and environmental conditions.

With the intention of providing operators with reasonable protection from falling objects, two levels of FOPS (Falling-Object Protective Structure) acceptance criteria have been developed based on end use:

- Level 1...protection from falling bricks, small concrete blocks and hand encountered in operations such as highway maintenance, landscaping and other construction site services.
- Level 2...protection from falling trees or rocks for machines involved in site clearing, overhead demolition or forestry.

This machine is equipped with a Level 1 FOPS as standard equipment. DO NOT use this machine in an application that may involve the hazards of falling trees or rocks. If Level 2 FOPS protection is required in your application, contact your dealer or the manufacturer concerning the possible availability of such protection.

Use a signal person and flagman



Know and use the hand signals required for particular jobs and make sure who has the responsibility for signaling.

- All personnel must fully understand all the signals.
- The operator shall respond to signals only from the appointed signal person, but shall obey a stop signal at any time from anyone.
- The signal person must stand in a clearly visible location when giving signals.

Be sure to raise the safety bar before leaving the operator's seat

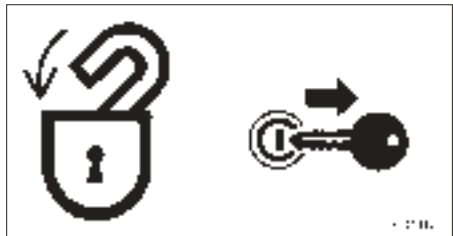

- Before leaving the operator's seat:
 - Lower the lift arms to the ground or engage the lift arm stop.
 - Stop the engine.
 - Raise the safety bar to engage the lock.
 - Remove the key and take it with you.
- If any controls are touched accidentally when the safety bar is lowered, the machine will move suddenly, and cause serious injury or death.



SAFETY

General Precautions

Avoid fire and explosion hazards



Keep flames away from fuel, hydraulic fluid, oil, grease and antifreeze. Fuel is particularly flammable and dangerous.

- When handling these combustible materials, keep lit cigarettes, matches, lighters and other flames or sources of flames away.
- Do not smoke or permit open flames while fueling or near fueling operations.
- Never remove the fuel cap or refuel with the engine running or hot. Never allow fuel to spill on hot machine components.
- Clean up spilled fuel, oil and other flammable fluids immediately.
- Check for fuel, oil and hydraulic fluid leaks. Stop all leaks and clean the machine before operating.
- Do not cut or weld on pipes or tubes that contain flammable fluids. Clean thoroughly with nonflammable solvent before cutting or welding.
- Remove all trash and debris from the machine. Make sure that oily rags and other flammable material are not stored on the machine.
- Handle all solvents and dry chemicals according to procedures identified on manufacturers' containers. Work in a well-ventilated area.
- Never use fuel for cleaning purposes. Always use a nonflammable solvent.
- Store all flammable fluids and materials in a safe, fireproof and well-ventilated place.

Fire prevention



When working in a certain environment, it is impossible to prevent combustible debris from collecting in the machine. This debris, in itself, may cause a fire; however, when mixed with fuel, oil or grease in a hot or confined place, the danger of fire is greatly increased.

The following fire prevention guidelines should be used to supplement the operator's fire prevention efforts. In no case should the guidelines be used, or assumed, as replacements for diligent operator efforts at preventing fires. (that include regular schedule of cleaning and inspecting the machine as conditions require.)

The following guidelines will help to keep your equipment up and running efficiently and keep the risk of fire to a minimum.

1. Maintain a CHARGED fire extinguisher on or near the machine at all times and KNOW HOW TO USE IT.
2. Remove debris and blow out dust regularly from side air intake areas, engine radiator, hydraulic oil cooler, air conditioning condenser core to prevent overheating of the engine and hydraulics and to maintain efficient operation of the machine.
3. Blow off all accumulated debris near hot engine exhaust components (turbocharger and exhaust manifold as well as exhaust pipes and muffler) at the completion of each work shift or more frequently when



working in severe conditions where large amounts of combustible debris are present. Engine exhaust systems provide numerous small pockets where flammable debris can gather. Even small accumulations close to hot exhaust components can ignite and smolder.

4. Clean out all accumulated debris (twigs, pine needles, branches, bark, leaves, saw dust, small wood chips) and any other combustible materials from inside the machine belly pans or lower machine structures as well as from areas in proximity to the engine, fuel and hydraulic oil systems no less frequently than at the completion of each work shift.
5. Inspect the machine regularly for any signs of diesel fuel or hydraulic system leakage. Check for worn or damaged fuel or hydraulic lines before starting up any equipment.
6. Clean up any grease, diesel fuel, hydraulic and lubricating oil accumulation and spillage immediately.
7. Steamclean the engine, and belly pan areas at least once a month or more frequently when working in severe conditions where large amounts of combustible debris are present.
8. Use only nonflammable solutions for cleaning the machine and components.
9. Inspect the exhaust system daily for any signs of leakage. Check for worn, cracked, broken or damaged pipes or muffler. Also check for missing or damaged bolts or clamps. Should any exhaust leaks or defective parts be found, repairs must be made immediately. Engine exhaust leaks can cause fires. Do not operate the machine until the exhaust leak is repaired.
10. During daily operation of the machine, the occurrence of exhaust leaks are usually accompanied by a change or

increase in engine exhaust noise levels. These audible warnings cannot be ignored. Should any exhaust leaks occur during operation, the machine must be shut down immediately and not put back to work until the necessary repairs have been completed.

11. Before starting repair work, such as welding, the surrounding area should be cleaned and a fire extinguisher should be close by.
12. Do not use the machine on top of or to push piles of burning timber. A machine fire will likely result.

What to do to prepare for a machine fire

- Prevent the fire from happening in the first place by ensuring that all machine systems are frequently inspected and always well maintained.
- Ensure that any hand held fire extinguishers are charged and in working order. Fire extinguishers require routine care. Follow the manufacturer's instructions for inspection and maintenance shown on the label of the fire extinguisher and in the extinguisher manufacturer's manual.
- Ensure that you follow all national, state / provincial and local regulations dealing with fire fighting in effect in your specific geographic region.
- Ensure that all information necessary for you to immediately contact all sources of help (local fire department, etc) in the event of a fire emergency is recorded and readily available at all times.



What to do if a machine fire occurs

If operating the machine when a fire occurs:

1. Lower all working attachments to the ground.
2. Shut the engine off.
3. Exit the machine. Call for help. Be certain to report a fire immediately.
4. At all times ensure your own personal safety and the safety of anyone that may be in the area. Approach any fire with extreme caution. All fires can be very dangerous and life threatening.

Before deciding to fight the fire, be certain that:

1. The fire is small and not rapidly spreading.
 2. There is always a clear, safe escape route.
 3. You have received training in the use of the available fire extinguishing devices and are confident that you can operate them effectively.
- Be aware that engine coolant, diesel fuel or hydraulic hoses could fail during a fire. If this happens, hot coolant, fuel or oil could possibly be ignited by the fire.
 - If in any doubt about whether or not to fight the fire – DON'T. Instead stand well clear of the fire and wait for help to arrive.
 - Use the **PASS** method. This is the most effective use of a fire extinguisher.
 - **P**ull the pin at the top of the extinguisher that keeps the handle from being pressed. Break the plastic seal as the pin is pulled.
 - **A**im the nozzle at the base of the fire. Do not aim the nozzle at the flames. In order to put out the fire, you must extinguish the fuel, not the flames. Hose nozzles are often clipped to the extinguisher body. Release the hose before taking aim.

- Squeeze the handle to release the pressurized extinguishing agent. The handle can be released at any time to stop the discharge.
- Sweep from side to side at the base of the fire until the fire is completely out or the fire extinguisher is empty
- Only if you can safely do so, open the access panels to the machine in the area of the fire.
- Failing all attempts to access the machine compartment, discharge the extinguisher through the mesh or any available openings on the machine.
- Ensure that the machine and all components have cooled down sufficiently after a fire so that re-ignition does not occur.
- Remain in the area until help arrives.

What to do after a machine fire has occurred

- Before returning the machine to work.
 1. Ensure that the cause of the fire is determined and all appropriate repairs are completed.
 2. Ensure that all extinguishers used in fighting the fire are replaced or recharged.
- Notify your equipment dealer and / or GEHL Manufacturing.



SAFETY

General Precautions

Exhaust fumes from the engine can kill



- Do not operate the engine in an enclosed area without adequate ventilation.
- If natural ventilation is poor, install ventilators, fans, exhaust extension pipes or other artificial venting devices.

Handling asbestos dust

Inhaling asbestos dust has been linked to lung cancer. When handling materials which may contain asbestos, take the following precautions:

- Never use compressed air for cleaning.
- Avoid brushing or grinding of the materials.
- For clean up, use wet methods or a vacuum equipped with a high efficiency particulate air (HEPA) filter.
- Wear an approved respirator if there is no other way to control the dust. When working indoors, install a ventilation system with a macro molecular filter.



SAFETY

General Precautions

Be careful not to get crushed or cut

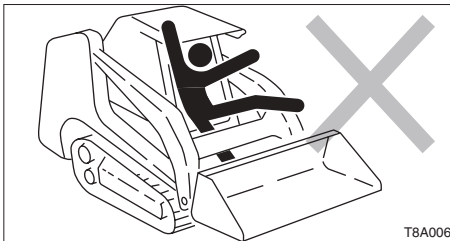
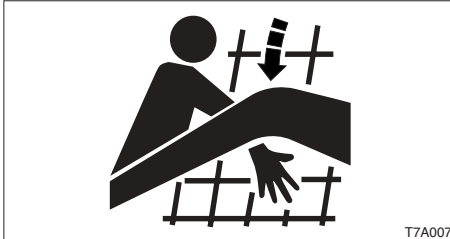

- Your body, hands and feet must not enter between moving parts, such as between lift arms and main body, or between lift arms and bucket. When operating lift arms and bucket, the gap between the moving parts will be changing, and getting caught in between can cause serious injury or death.
- The lift arms move close to the outside of the side screens; never stick out arms or other portions of your body from the side screens.
- The lift arms move close to the ROPS; therefore, do not stand or lean on the machine.

Using optional products

- Consult with a Gehl dealer before installing optional attachments.
- Do not use attachments that have not been approved by Gehl. Doing so may compromise safety or adversely affect the machine's operation or service life.
- Gehl will not be responsible for any injuries, accidents or damage to its products caused by the use of a non-approved attachment.

Product usage

Keep in mind that the use of high-output brush cutter attachments on this unit can only be used in part-time, lighter-duty brush clearing applications, with appropriate cooling system care and in moderate ambient temperatures. Care with respect to usage and prevention of track damage must also be adhered to.

This usage notice also applies to all other high-performance, high-demand attachments.

Never modify the machine

Unauthorized modifications to this machine can cause injury or death. Never make unauthorized modifications to any part of this machine.



Know the working area

Before starting operation, know the working area to ensure safety.

- Check the topography and ground condition of the working area, or the structure of the building when working indoors, and take the necessary safety measures in dangerous spots.
- Note and avoid all hazards and obstructions such as ditches, underground lines, trees, cliffs, overhead electrical wires and areas where there is danger of a slide.

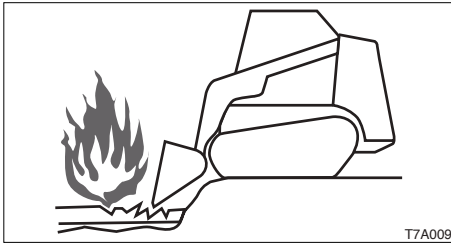

T7A009

- Check with the local utilities for the locations of buried gas and water pipes and buried power cables. Determine jointly what specific precautions must be taken to ensure safety.
- When working on roads, be sure to take into account the safety of pedestrians and vehicles.
 - Use a flagman and/or signals.
 - Fence off the working area and prohibit entry to unauthorized persons.
- When working in water or crossing shallow streams or creeks, check the depth of the water, the firmness of the ground, and the speed of the current beforehand. Make sure the water is not deeper than the allowable depth.

Refer to the section titled “Cautions on Use in Water” for further instructions.

Check the strength of the bridge

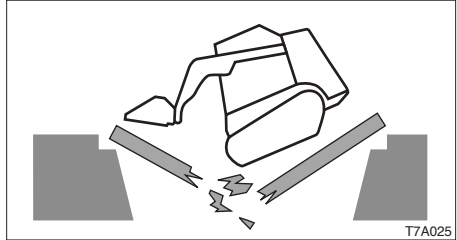

T7A025

When travelling over a bridge or other structure, check the permissible load. If the strength is insufficient, reinforce it.

Always keep the machine clean

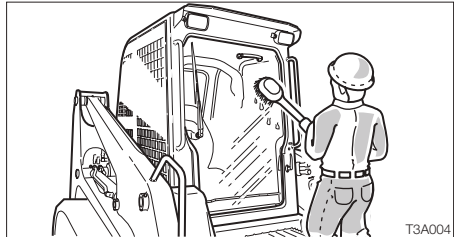

T3A004

- Clean windows, mirrors and lights to ensure good visibility.
- Wipe off any oil, grease, mud, snow and ice, to prevent accidents due to slipping.
- Remove all loose objects stored in the machine and all objects that do not belong in or on the machine and its equipment.
- Remove any dirt, oil and grease from the engine area, to prevent fires.
- Clean the area around the operator's seat, removing any potential obstacles.



SAFETY

Preparing Precautions

Perform inspection and maintenance daily



Failure to notice and repair machine malfunctions or damage can lead to accidents.

- Before operating, perform the prescribed inspections and make repairs immediately if any malfunctions are found.
- If a failure that causes loss of control, such as steering, service brakes or engine occurs, stop the machine motion as quickly as possible, follow the shutdown procedure, and keep machine securely parked until the malfunction is corrected.

Emergency Exit

If you become trapped inside the cab, remove the rear window to get out.

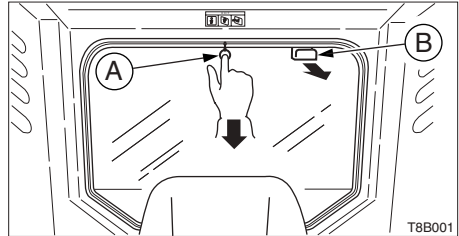

There are two ways to remove the rear window.

In case of emergency

Kick off the rear window. Note that the glass may break. Be careful not to get injured.

In case of need

1. Pull off ring (A) and remove the tip of the rubber wedge.
2. Grasp the tip, pull, and remove the entire rubber wedge.
3. Pull inside knob (B).

**Maintain three-point contact when mounting and dismounting**

- Do not jump on or off the machine. Never attempt to mount or dismount a moving machine.
- For machines with cab, when mounting and dismounting the cab, first open the door fully to the locked position and check that it does not move.



- Always face the access system and maintain a three-point contact with the recommended handrails and steps while getting on and off the machine. Keep steps and platform clean.
- Never use the control levers as hand holds.
- Do not go under the raised lift arms if they are not sufficiently supported.
- Lower the lift arms to the ground before mounting or dismounting the cab.

Clear the area of other persons before starting the machine

Do not start the engine until you are sure it is safe. Before starting, check or perform the following.

- Walk around the machine and warn all personnel who may be servicing the machine or are in the machine path. Do not start until all personnel are clearly away from the machine.
- Check for any “DO NOT OPERATE” tags or similar warning notices on the cab door, controls and ignition switch.
- Sound horn to alert everyone around the machine.

Start the engine from the operator's seat

- Adjust, secure and latch the operator's seat.



- Fasten the seat belt.
- Check that the parking brake is applied and place all controls in the neutral position.
- Check that the safety bar is in the lock position.
- Clear the area of all persons.
- Start and operate the engine from the operator's seat only.
- Never attempt to start the engine by shorting across the starter terminals.

**Starting with jumper cables**

Use jumper cables only in the recommended manner. Improper use of jumper cables can result in battery explosion or unexpected machine motion.

Refer to the section titled “If the Battery Goes Dead” for proper instructions.

After starting the engine

After starting the engine, perform the following operations and checks in a safe place with no persons or obstacles in the area. If any malfunctions are found, follow the shutdown procedure and report the malfunction.

- Warm up the engine and hydraulics.
- Observe all gauges and warning instruments for proper operation.
- Listen for unusual noises.
- Test engine speed control.
- Operate each control to ensure proper operation.

In cold weather

- Be careful of slippery conditions on freezing ground, steps and hand holds.
- In severe cold weather, do not touch any metal parts of the machine with exposed flesh, because flesh can freeze to the metal and cause injury.
- Do not use ether or starting fluids on this engine. These starting aids can cause explosion and serious injury or death.
- Warm up the engine and hydraulic fluid before operating.



SAFETY

Operating Precautions

Ensure good visibility

- When working in dark places, turn on the machine's working lights and headlights and/or provide extra stationary lighting if necessary.
- When visibility is poor due to severe weather (fog, snow or rain), stop operating the machine and wait until conditions improve.

Do not permit riders on the machine



- Do not allow anyone to ride on any part of the machine at any time while traveling.
- Do not allow anyone to be on any part of the machine while operating.

Operate the machine only from the operator's seat

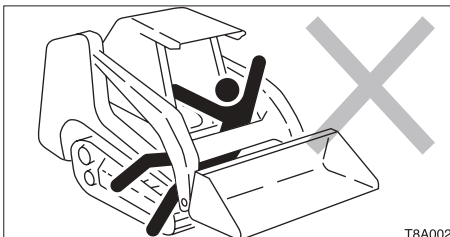

Operate all the controls only from the operator's seat. Failure to do so can cause serious injury or death.

Check for safety in the surrounding area before starting

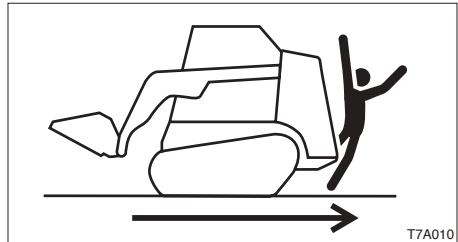

- Understand the machine limitations.
- Use a signal person where clearances are close or your vision is obstructed.
- Never allow anyone to enter the turning radius and machine path.
- Signal your intention to move by sounding the horn.
- There are blind spots to the rear of the machine.

If necessary, before backing up, check that the area is safe and clear.

Keep your body inside the operator's cab

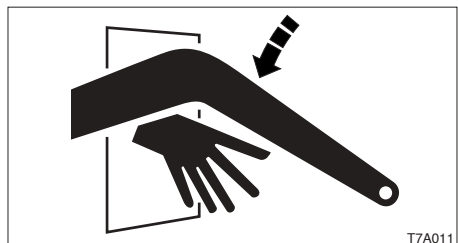

Keep your body inside the operator's compartment while operating the loader. Never work with your arms, feet or legs beyond the operator's compartment.

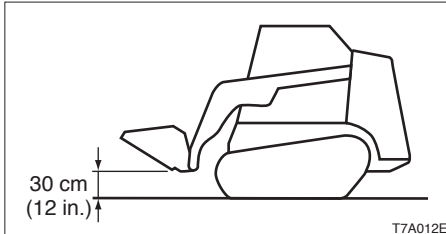
**Cautions on traveling and turning**

- Traveling and turning should be performed with the bucket cylinder fully retracted and the bucket at a height of approximately 30 cm (12 in.) from the ground.
- Avoid sudden stops, starts and turns.
- Do not raise the safety bar while traveling. This is dangerous, because raising the safety bar will cause the parking brakes of the travel motors to operate and apply the brakes abruptly.
- Do not switch off the ignition switch while traveling. Doing so will cause sudden braking and is dangerous.
- Before backing up, visually check for safety to the rear. Backing up without checking could result in contact with a worker or obstacle.
- If the working equipment must be operated while traveling, do so with extra care.

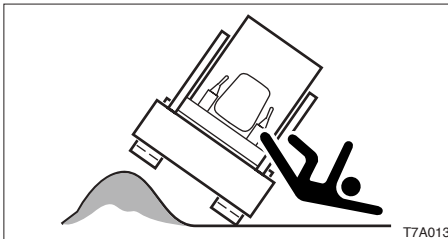

- When traveling, try not to cross over obstacles. When crossing over something cannot be avoided, keep the bucket close to the ground and travel slowly. Also note that the machine must not cross over an

obstacle with the machine body on an extreme slope (of 15 degrees or more).

- When traveling on rough terrain or when carrying a load, lower the load and travel slowly.



SAFETY

Operating Precautions

Cautions on traveling on slopes

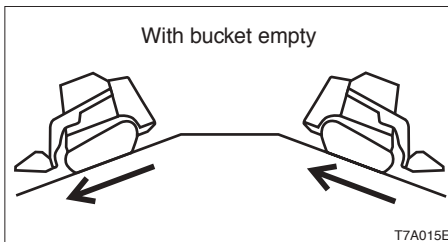
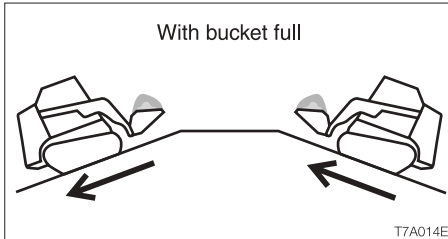

Work should not be performed on a slope, because the stability of the machine can be adversely affected when operating the working equipment and there is the possibility of the machine tipping over.

When traveling on a slope, be cautious of tipping over or sliding sideways.

When traveling on a slope, position the heavier end of the machine (front or back, whichever is heavier) pointing up the slope.

- When going up or down slopes having a gradient of 15 degrees or more, travel up and down slope with the heavy end of the machine pointed uphill.
- When traveling on a slope, lower the bucket to a height of 20 to 30 cm (8 to 12 in.) above the ground, and in case of an emergency, lower the bucket to the ground and stop the machine.
- Travel at slow speeds on slopes. Especially when going down slopes, reduce the engine (r.p.m.) speed and set the stroke of the left control lever to half or less before going down. Going down a slope too fast will lead to loss of control.

- Sudden stopping on a sloped road may lead to loss of stability and the machine could tip over.

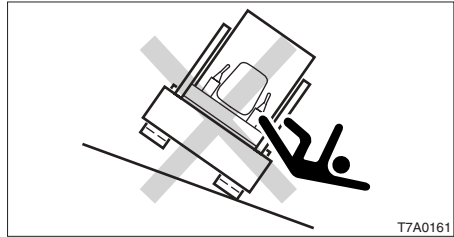

- Traveling across an inclined surface at an angle or traveling straight across an inclined surface could result in slipping sideways or tipping over. Travel straight up and down the slope.
- When traveling over grass or fallen leaves, wet iron plates or frozen surfaces, the machine might unexpectedly slide sideways when on even a slight slope. Do not allow the machine to become positioned across the slope.

Use caution when floating the lift arms

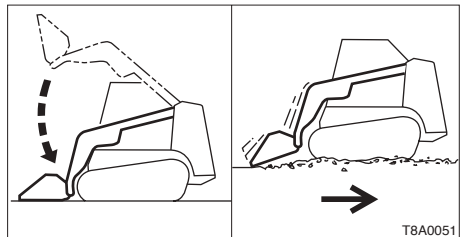

- Make sure the bucket is lowered to the ground before actuating the lift arms Float control. Actuating the Float control when the lift arms are raised will cause the bucket to fall rapidly and is extremely dangerous.
- Do not drive the loader forward with the lift arms in Float position.



SAFETY

Operating Precautions

Do not drive into materials at high speeds

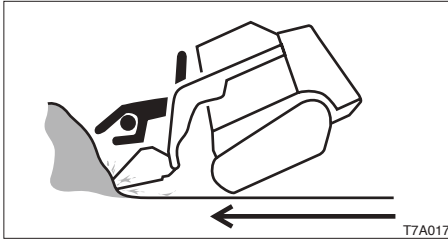

Driving at high speed into the materials you are handling can lead to your body striking the machine or being thrown from the machine. Check the conditions surrounding the area in front of the material you are handling and work at low speeds.

Do not carry the bucket over the heads of people

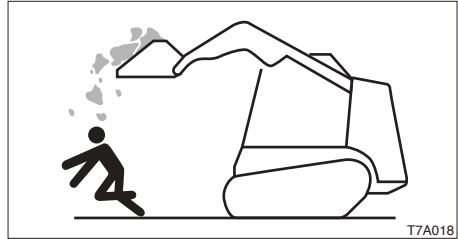

Carrying the bucket over the heads of people entails the danger of the load spilling or the bucket suddenly dropping.

Operate on snow or ice with extra caution

- When traveling on snow or frozen surfaces, keep the machine travel speed down and avoid accelerating, stopping and changing directions abruptly.
- Remember that the road shoulder, fences, etc., may be buried in the snow and not visible.
- Lower the bucket when parked on unsure ground conditions.

Caution against falling unstable loads

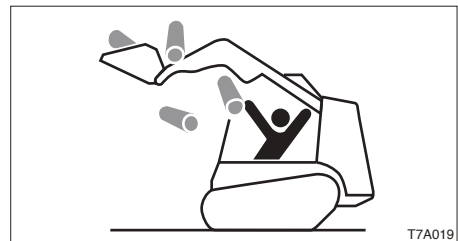

Unstable loads such as round items, cylindrical items, and stacked plates entail the possibility of falling from the bucket. When handling unstable loads, operate carefully to avoid raising the bucket too high or tilting it too far rearward.



SAFETY

Operating Precautions

Do not suddenly stop or lower the working equipment

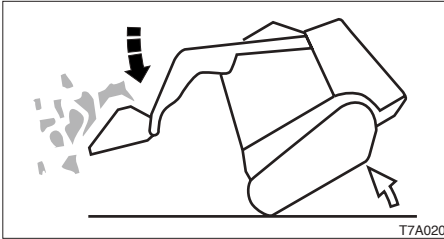

Sudden lowering or stopping of the working equipment could cause the machine to tip bowed forward.

Operate the working equipment carefully, especially when the bucket is loaded.

Avoid overloading and off-center loads

Filling the bucket in excess of the maximum load and loading an off-center load will cause the machine to become unstable and could result in the machine tipping over. Loading should be done evenly, should be less than the: CTL55: 565 kg (1246 lbs.); CTL65: 835 kg (1841 lbs.); CTL75: 945 kg (2083 lbs.); CTL85: 1190 kg (2624 lbs.).

Keep a safe distance from electrical power lines

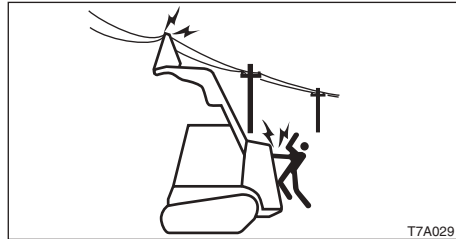

Never approach power lines with any part of the machine and its load unless all local and national required safety precautions have been taken. Electrocution and death can result from arcing, touching or even being close to a machine that is in contact with or near an electrical source.

- Maintain the maximum possible distance from power lines and never violate the minimum clearance.
- Always contact the nearest electric utility and determine jointly what specific precautions must be taken to ensure safety.
- Consider all lines to be power lines and treat all power lines as energized, even if it is known or believed that the power is shut off and the line is visibly grounded.
- Use a signal person to observe the approach of any part of the machine or load to the power line.
- Caution all ground personnel to stand clear of the machine and the load at all times.
- If the machine should come in contact with a live electrical source, do not leave the operator's seat. Do not allow anyone to approach or touch the machine.
- Be especially careful of buried high-voltage power lines.



SAFETY

Operating Precautions

Watch out for hazardous working conditions

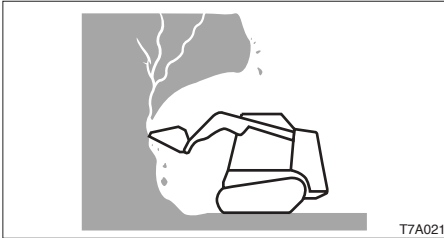

T7A021

- Never undercut a high bank. Be particularly alert for the possibility of a cave-in.
- Do not operate in places where there is a danger of falling rocks.
- Do not approach unstable surfaces (cliffs, road shoulders, deep trenches, etc.). The ground may give way under the machine's weight or vibrations, causing the machine to tip over.
 - The ground is weak after rain or explosions.
 - The ground is also unstable on banks and near dugout trenches.

Precautions when passing through tunnels or near high walls

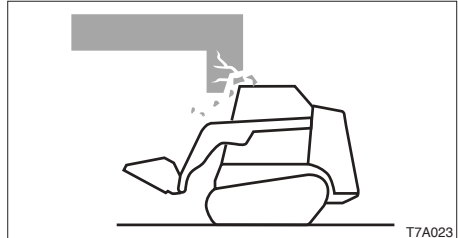

T7A023

Careless entry into tunnels or places with high walls can lead to serious accidents, such as contact accidents, etc. Check height and width limits in advance and verify that the machine is within the limits.

Travel in narrow or congested places

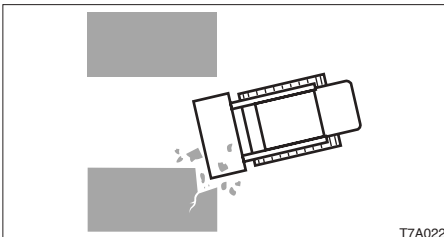

T7A022

To avoid contact accidents, pay attention to the surroundings at narrow sites, indoors, and congested places and operate at speeds at which the machine can be safely operated.

Do not drive on soft ground

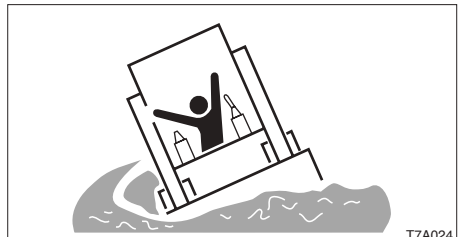

T7A024

Driving onto soft ground can result in the machine tilting on its own weight, tipping over, or falling in. Do not enter weak ground such as that following back-filling.



SAFETY

Operating Precautions

Loaders are NOT designed for lifting loads

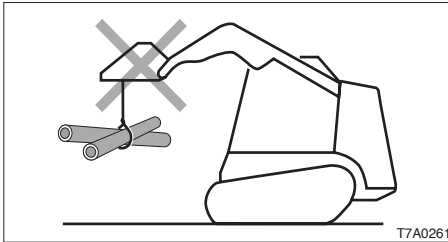

The machine is NOT specifically designed for lifting loads and has no safety devices for crane operation.

Danger of flying objects

This machine is not equipped with protective guards to protect the operator from flying objects. Do not use the machine in places where there are risks of the operator being hit by flying objects.

Cautions on towing

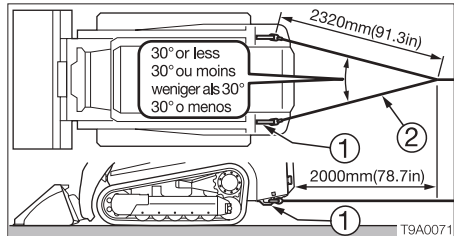

When towing, selecting the wrong wire rope, inspecting improperly, or towing in the wrong manner could lead to accidents, resulting in serious injury or death.

- The wire rope breaking or coming detached could be extremely dangerous. Use a wire rope suited for the required tractive force.
- Do not use a wire rope that is kinked, twisted or otherwise damaged.
- Do not apply strong loads abruptly to the wire rope.
- Use safety gloves when handling the wire rope.
- Make sure there is an operator on the machine being towed as well as on the machine that is towing.
- Never tow on slopes.
- Do not let anyone near the wire rope while towing.



SAFETY

Stopping Precautions

Park safely

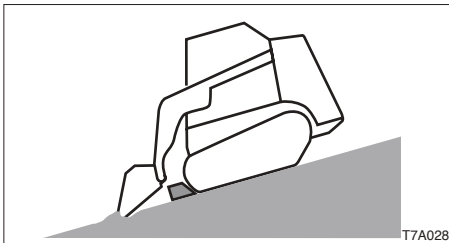
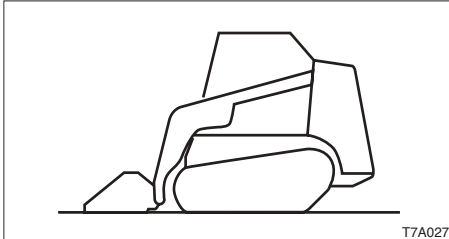

- Park the machine on firm, level ground and apply the parking brake. If you must park on a slope or incline, block the machine securely to prevent movement.
- When parking on streets, use barriers, caution signs, lights, etc., so that the machine can easily be seen at night to avoid collisions with other vehicles.

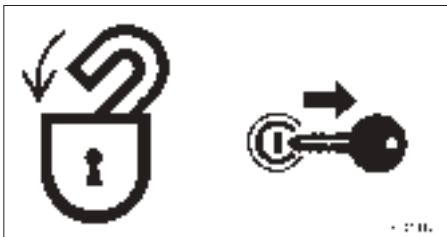

- Before leaving the machine, do the following:
 1. Lower the bucket to the ground.
 2. Set the safety bar in the lock (raised) position.
 3. Stop the engine and remove the key.
 4. Lock the covers.

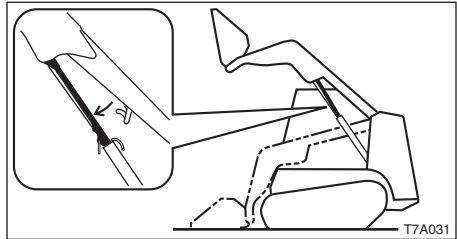

- Never leave the machine with the engine running or the lift arms raised, unattended. If lift arms are left in a raised position, they **MUST** be supported by the lift arm stop.



Load and unload the machine safely

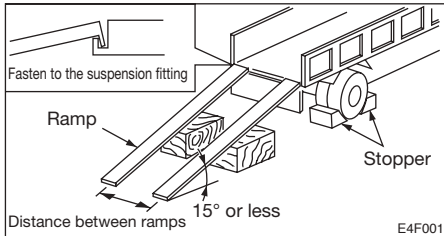

The machine may roll or tip over or fall while loading or unloading it. Take the following precautions:

- Select a firm, level surface and keep sufficient distance from road shoulders.
- Use loading ramps of adequate strength and size. Maintain the slope of loading ramps to 15 degrees or less.
- Secure the ramps to the truck bed.
- Keep the truck bed and loading ramps clean of oil, clay, ice, snow, and other materials that can become slippery. Clean the tracks.
- Block the transport vehicle so it cannot move.
- Use a signal person when loading and unloading the machine, and travel slowly in first gear (low speed).
- Never change course on the ramp.
- Do not turn on the ramps. The machine may tip over.
- Block both tracks and secure the machine to the truck bed with load binders.

Transport the machine safely

- Know and follow the safety rules, vehicle code and traffic laws when transporting the machine.
- Consider the length, width, height and weight of the truck with the machine loaded on it when determining the best route.

Hoisting the machine safely

- Know and use correct crane signals.
- Inspect the hoisting equipment daily for damaged or missing parts.
- When hoisting, use a wire rope with sufficient strength with respect to the machine's weight.
- Do not hoist the machine with an operator on it.
- When hoisting, hoist slowly so that the machine does not tip.
- Keep all other persons out of the area when hoisting. Do not move the machine over the heads of the persons.
- Do not hoist with the machine in a position other than the one described in the procedure below. Doing so is dangerous because it may result in the machine losing its balance. Refer to the section titled "Hoisting the Machine" for further details.

**Attach a “DO NOT OPERATE” tag**

Severe injury could result if an unauthorized person starts the engine or touches controls during inspection or maintenance.

- Stop the engine and remove the key before performing maintenance.
- Attach a “DO NOT OPERATE” tag to the ignition switch or control lever.

Use the correct tools

Do not use damaged or weakened tools, or tools designed for other purposes. Use tools suited for the operation.

Replace important safety parts periodically

- Replace fuel hoses periodically. Fuel hoses become weaker over time, even if they appear to be in good condition.
- Replace important safety parts whenever a malfunction is found, even if it is before the normal time for replacement. Refer to the section titled “Important Parts” for further details.

Anti-explosive lighting

Use anti-explosive electrical fixtures and lights when inspecting fuel, oil, coolant, battery fluid, etc. If lighting that is not anti-explosive breaks, the substance could ignite, resulting in serious injury or death.

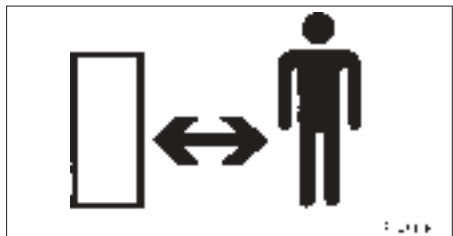
Do not allow unauthorized personnel in the work area

Do not allow unauthorized personnel in the work area. Chips or other debris can fly off machine parts when grinding, welding or using a hammer.



SAFETY

Maintenance Precautions

Prepare the work area

- Select a firm, level work area. Make sure there is adequate light and, if indoors, ventilation.
- Clear obstacles and dangerous objects. Eliminate slippery areas.

Stop the engine before performing maintenance

- Avoid lubrication or mechanical adjustments with the machine in motion or with the engine running while stationary.
- If maintenance must be performed with the engine running, always work as a two-person team, with one person sitting in the operator's seat while the other works on the machine.
 - When performing maintenance, be sure to keep your body and clothing away from moving parts.

Always clean the machine



- Clean the machine before performing maintenance.
- Stop the engine before washing the machine. Cover the electrical parts so that water cannot enter. Water on electrical parts could cause short-circuits or malfunctions. Do not use water or steam to wash the battery, electronic control components, sensors, connectors or the operator's compartment.

Stay clear of moving parts



- Stay clear of all rotating and moving parts. Wrapping or entanglement may result in serious injury or death.
- Keep hands, clothing and tools away from the rotating fan and running fan belts.



SAFETY

Maintenance Precautions

Securely block the machine or any component that may fall



- Before performing maintenance or repairs under the machine, set the bucket against the ground or in the lowermost position.
- Securely block the tracks.
- If you must work beneath the raised machine or equipment, always use lift arm stop, jack-stands or other rigid and stable supports. Never get under the machine or working equipment if they are not sufficiently supported. This procedure is especially important when working on hydraulic cylinders.

Securely block the raised lift arms

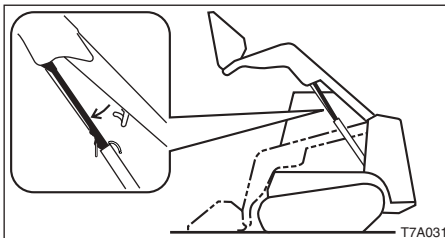

- If you must work beneath the raised lift arms, securely engage the lift arm stop. Never get under the lift arms and bucket if they are not sufficiently supported.
- Disconnecting or loosening any hydraulic line, hose, fitting or component or a parts failure can cause the lift arms to drop.

- Service the lift arm stop if damaged or if parts are missing. Using a damaged lift arm stop or with missing parts can cause the lift arms to drop, causing injury or death.

Secure the rear door when opened

Be sure to secure the rear door when opening it. Do not open the rear door on slopes or in strong wind.

Cautions on tilting up the ROPS

- Raising or lowering the ROPS while the engine is running may cause the machine to move, and cause serious injury or death. Lower the working equipment to the ground and stop the engine before raising or lowering the ROPS.
- When the ROPS is tilted up, support it firmly with the stop to prevent it from falling.

Place heavy objects in a stable position



When removing or installing the bucket or attachment, place it in a stable position so that it does not tip over.

**Use caution when fueling**

- Do not smoke or permit open flames while fueling or near fueling operations.
- Never remove the fuel cap or refuel with the engine running or hot. Never allow fuel to spill on hot machine components.
- Maintain control of the fuel filler nozzle when filling the tank.
- Do not fill the fuel tank to capacity. Allow room for expansion.
- Clean up spilled fuel immediately.
- Tighten the fuel tank cap securely. If the fuel cap is lost, replace it only with the original manufacturer's approved cap. Use of a non-approved cap without proper venting may result in pressurization of the tank.
- Never use fuel for cleaning purposes.
- Use the correct fuel grade for the operating season.

Handling of hoses

Fuel, oil and hydraulic fluid leaks can cause a fire.

- Do not twist, bend or hit the hoses.
- Never use twisted, bent or cracked hoses, tubes and pipes. They may burst.
- Retighten loose connections.

Be careful with hot and pressurized components

Stop the engine and allow the machine to cool down before performing inspection and maintenance.

- The engine, muffler, radiator, hydraulic lines, sliding parts and many other parts of the machine are hot after the engine is stopped. Touching these parts will cause burns.
- The engine coolant, oil and hydraulic fluid are also hot and under high pressure. Be careful when loosening caps and plugs. Working on the machine under these conditions could result in burns or injuries due to the hot oil spraying out.



SAFETY

Maintenance Precautions

Be careful with hot cooling systems



Do not remove the radiator cap or drain plugs when the coolant is hot. Stop the engine, let the engine and radiator cool, and loosen the radiator cap or drain plugs slowly.

Be careful with fluids under pressure

Pressure can be retained in the hydraulic circuit long after the engine has been shut down.

- Release all pressure before working on the hydraulic system.



- Hydraulic fluid under pressure can penetrate the skin and eyes and cause injury, blindness or death. Fluid escaping from a small hole can be almost invisible. Wear safety goggles and heavy gloves, and use a piece of cardboard or wood to search for suspected leaks.

If fluid is injected into the skin, it must be removed within a few hours by a doctor familiar with this type of injury.

Release all pressure before working on the hydraulic system

Oil may spray out if caps or filters are removed or pipes disconnected before releasing the pressure in the hydraulic system.

- When removing plugs and screws and disconnecting hoses, stand to the side and loosen slowly to gradually release the internal pressure before removing.

Be careful with grease under pressure



The track adjuster contains highly pressurized grease. If the tension is adjusted without following the prescribed procedure, the grease discharge valve may fly off, resulting in injury.

- Loosen the grease discharge valve slowly.
- Do not put your face, arms, legs or body in front of the grease discharge valve.
- If no grease is expelled when grease discharge valve is loosened, there is a problem. Contact your nearest service outlet for repairs. DO NOT disassemble, because this is very dangerous.



Never disassemble the track adjuster

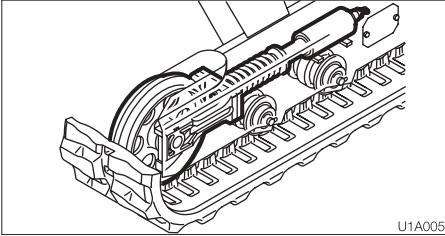

There is very strong spring contained in the track adjuster. If the track adjuster is accidentally disassembled, the spring can pop out, resulting in serious injury never disassemble the track adjuster.

Disconnect the battery



Disconnect the battery before working on the electrical system or doing any welding. Remove the negative (-) battery cable first. When reconnecting the battery, connect the negative (-) battery cable last.

Avoid battery hazards

- Batteries contain sulfuric acid, which will damage eyes and skin on contact.
 - If acid contacts eyes, flush immediately with clean water and get prompt medical attention.
- If acid is accidentally swallowed, drink large quantities of water or milk and call a physician immediately.
- If acid contacts skin or clothing, wash off immediately with clean water.
- Wear safety glasses and gloves when working with batteries.
- Batteries generate flammable and explosive gases. Keep arcs, sparks, flames and lighted tobacco away.
- Use a flashlight to check battery electrolyte level.
- Stop the engine and shut off electrical equipment while inspecting or handling the battery.
- Do not short circuit the battery posts with metal items.
- Always unfasten the negative (-) battery cable first when disconnecting the battery cable. Always connect the negative (-) battery cable last when fastening the battery cable.
- Loose battery terminals may result in sparks. Be sure to fasten terminals tightly.
- Make sure the vent caps are tightened securely.
- Do not charge a battery or jump-start the engine if the battery is frozen. Warm to 15°C (60°F) or the battery may explode.
- Do not use the battery when the fluid level is below the lower level. Doing so will hasten the deterioration of the internal portions of the battery and shorten the battery life, and can also cause rupturing (or an explosion).
- Do not fill the battery above the upper level. Doing so could cause the fluid to leak, contact and damage the skin, or cause parts to corrode.



Have a Gehl technician repair weld cracks or other damage

If welding must be performed, make sure that it is done by a qualified person in a properly equipped workplace. To prevent any part from breaking down or being damaged due to overcurrent or sparks, observe the following.

- Disconnect the wiring from the battery before doing electric welding.
- Do not continuously apply 200V or more.
- The earth ground must be connected within one meter from the welding section. Do not connect the earth ground near to an electronically controlled device/instrument or connectors.
- Make sure that there are no seals or bearings between the welding section and the earth ground.
- Do not connect the earth ground around the pins for working equipment or hydraulic cylinders.
- When welding is to be done on the machine body, disconnect the connectors for the electronically controlled devices before working.

Safety signs

- Keep all safety signs clean and legible.
- Replace all missing, illegible or damaged safety and warning signs.

Vibrations to which the operator is subjected

According to the results of the tests carried out to determine the vibrations transmitted to the operator by the machine, the upper limbs are subjected to vibrations lower than $2.5 \text{ m (8.2 ft.) / s}^2$, while the seated part of the body is subjected to vibrations lower than $0.5 \text{ m (1.64 ft.) / s}^2$.

Checks after maintenance

- Gradually raise the engine speed from low idle to maximum speed and check that no oil or water is leaking from serviced parts.
- Move the controls and check that the machine is operating properly.

Disposing of wastes

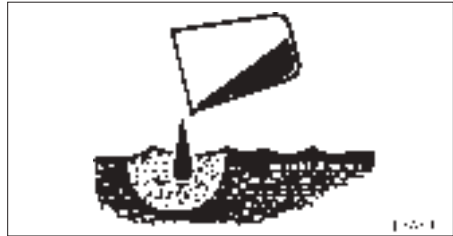

- Pour waste fluids from the machine into containers. Disposing of fluids improperly destroys the environment.
- Follow the prescribed regulations when disposing of oil, fuel, engine coolant, refrigerant, solvents, filters, batteries and other harmful substances.

Handling of poisonous chemicals

Poisonous chemicals will cause serious injury if directly contacted.

Poisonous chemistry used in this machine includes grease, battery solution, coolant, paint and adhesive agent.



SAFETY

Safety Signs (Decals)

The following safety signs (decals) have been placed on the machine in the areas indicated. They are intended for the personal safety of the operator, and co-workers. Please take this manual, walk around the machine and note the content and location of these safety signs. Review these signs and the operating instructions in this manual with all machine operators.

- Keep the safety signs legible. If they are not, obtain replacements from your Gehl dealer.

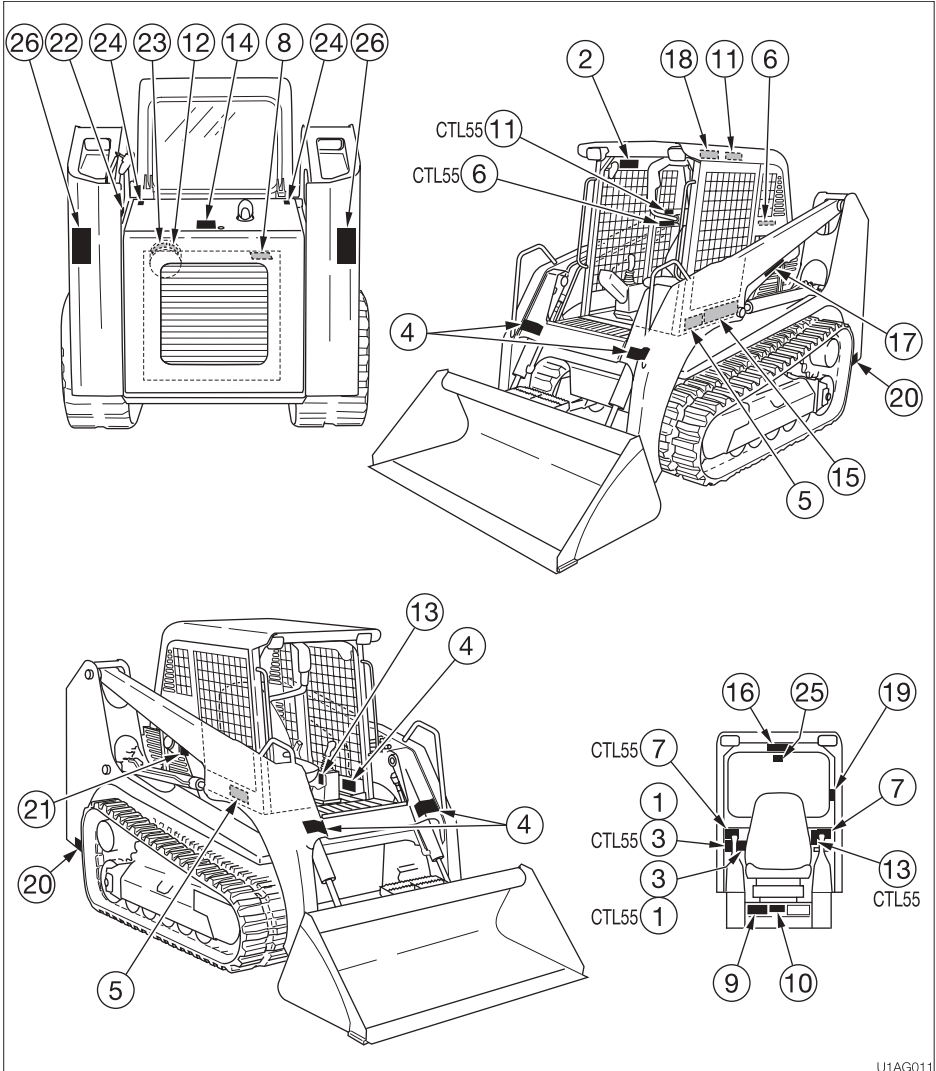

U1AG011



SAFETY

Safety Signs (Decals)

1. No.06593-00012



AVOID DEATH

- Before removing seat belt and leaving seat
- Lower lift arms to ground or rest lift arms on stops.
 - Stop engine.

2. No.08800-30010

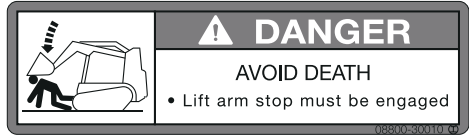

AVOID DEATH

- Lift arm stop must be engaged

3. No.06593-00013



AVOID INJURY

- Loader can move suddenly and violently
- Always wear seat belt

5. No.08800-31005



WARNING

- LIFT ARMS MOVE NEAR CANOPY FRAME.
- NEVER STAND OR LEAN ANYWHERE ON LOADER.

6. No.08810-30026

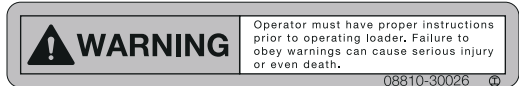

WARNING

Operator must have proper instructions prior to operating loader. Failure to obey warnings can cause serious injury or even death.

4. No.06593-00011



AVOID INJURY

- Lift arms move close by window opening
- Never place through screen opening

7. No.03593-13700

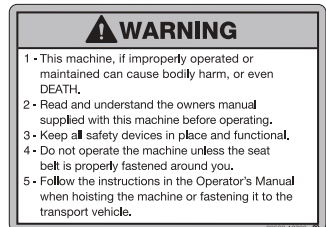

WARNING

- 1 - This machine, if improperly operated or maintained can cause bodily harm, or even DEATH.
- 2 - Read and understand the owners manual supplied with this machine before operating.
- 3 - Keep all safety devices in place and functional.
- 4 - Do not operate the machine unless the seat belt is properly fastened around you.
- 5 - Follow the instructions in the Operator's Manual when hoisting the machine or fastening it to the transport vehicle.



SAFETY

Safety Signs (Decals)

8. No.08820-31135



Sign indicates a burn hazard from spurting hot water or oil if radiator or hydraulic tank is uncapped while hot. Allow radiator or hydraulic tank to cool before removing cap.

9. No.08810-30020

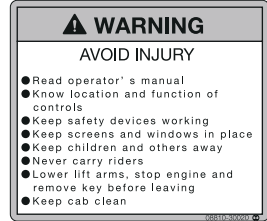

<CTL55>

10. No.06593-00009



<CTL65>

10. No.06693-00009



<CTL75>

10. No.08820-30009



<CTL85>

10. No.06993-00009



11. No.08800-30015



13. No.06893-00035



Sign indicates a crush hazard from falling off of working device. Keep away when the working device is raised.

12. No.03393-75040



14. No.03793-66006



Hazard of rotating parts. Turn off before inspection and maintenance.

15. No.06693-00110

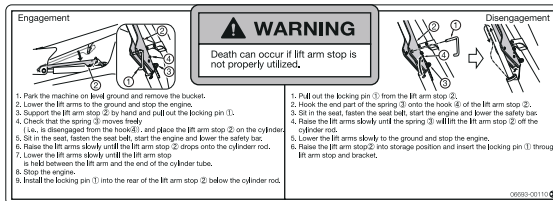

- Engagement**
1. Park the machine on level ground and remove the bucket.
 2. Lower the lift arms to the ground and stop the engine.
 3. Support the lift arm stop ② by hand and pull out the locking pin ①.
 4. Check that the spring ③ moves freely. (i.e., is disengaged from the hook ④), and place the lift arm stop ② on the cylinder ⑤.
 5. Sit in the seat, fasten the seat belt, start the engine and lower the safety bar.
 6. Raise the lift arms slowly until the lift arm stop ② drops onto the cylinder rod.
 7. Lower the lift arms slowly until the lift arm stop is held between the lift arm and the end of the cylinder tube.
 8. Stop the engine.
 9. Install the locking pin ① into the rear of the lift arm stop ② below the cylinder rod.

- Disengagement**
1. Pull out the locking pin ① from the lift arm stop ②.
 2. Hook the end part of the spring ③ onto the hook ④ of the lift arm stop ②.
 3. Sit in the seat, fasten the seat belt, start the engine and lower the safety bar.
 4. Raise the lift arms slowly until the spring ③ will fit the lift arm stop ② on the cylinder rod.
 5. Lower the lift arms slowly to the ground and stop the engine.
 6. Raise the lift arm stop ② into storage position and insert the locking pin ① through lift arm stop and bracket.

U1AG031



SAFETY

Safety Signs (Decals)

16. No.08800-31018

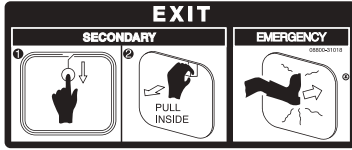

17. No.137637



18. No.08810-31551

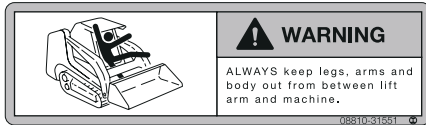

19. No.03993-00400



Position of Fire extinguisher

20.No.08810-31549



Tie down point

21. No.03593-06600



Diesel fuel

22. No.03593-06700



Hydraulic oil

23. No.06693-00014

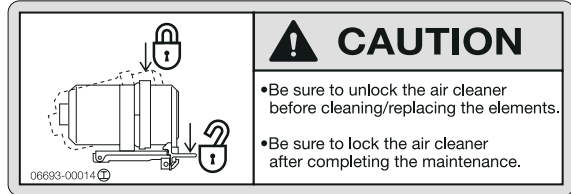

24. No.03993-00500



Position of Hoisting

25. No.08710-86051

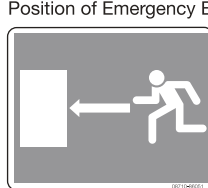

Position of Emergency Exit

26. No.08820-31159

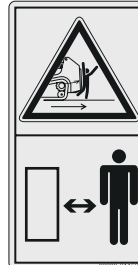

Safety Distance
Do not get near or stand within the machine working area.



CONTROLS

Names of Components.....	40
Doors and Covers.....	42
Seat and Seat Belt.....	48
Instrument Panel.....	52
Switches.....	54
Levers and Pedals.....	59
Accessories.....	61

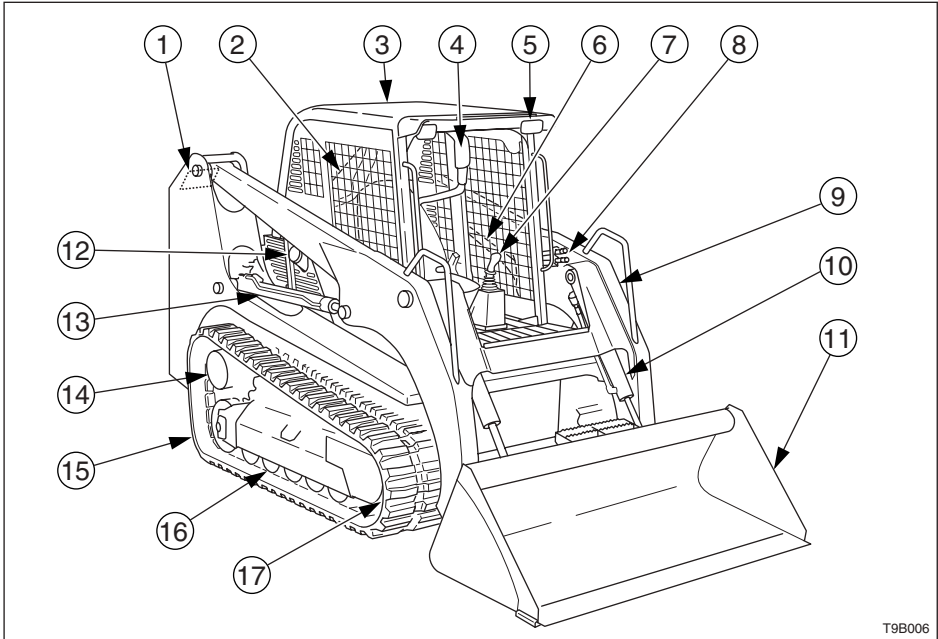

T9B006

- | | |
|------------------------------|---------------------|
| 1. Tail light | 10. Bucket cylinder |
| 2. Hydraulic tank | 11. Bucket |
| 3. ROPS / FOPS | 12. Fuel filler cap |
| 4. Safety bar | 13. Arm cylinder |
| 5. Front light | 14. Travel motor |
| 6. Lift arm stop | 15. Rubber track |
| 7. Left control lever | 16. Track roller |
| 8. Auxiliary hydraulic lines | 17. Idler |
| 9. Lift arm | |



CONTROLS

Names of Components

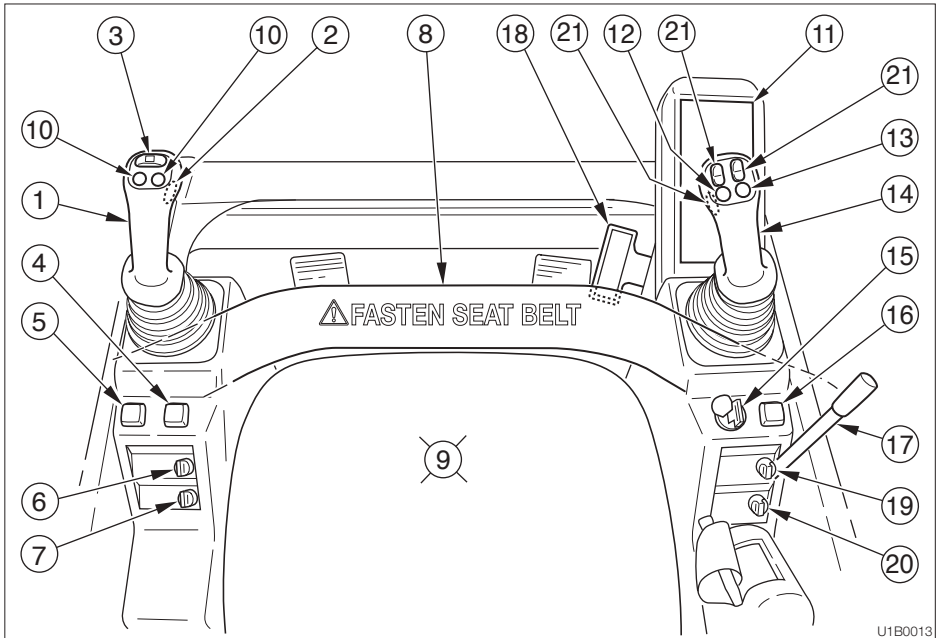

- | | |
|---|-------------------------------|
| 1. Left control lever | 12. Float button |
| 2. Travel speed button | 13. Horn button |
| 3. Slider switch (for auxiliary hydraulic) | 14. Right control lever |
| 4. Detent mode switch
(for auxiliary hydraulic switches) | 15. Ignition switch |
| 5. Flow selector switch (2-way → 1-way) | 16. High-flow switch (option) |
| 6. Front wiper switch (option) | 17. Throttle lever |
| 7. Rear wiper switch (option) | 18. Throttle pedal |
| 8. Safety bar | 19. Front light switch |
| 9. Seat | 20. Tail light switch |
| 10. Auxiliary hydraulic buttons | 21. Multifunction buttons |
| 11. Instrument panel | |



Ignition Key

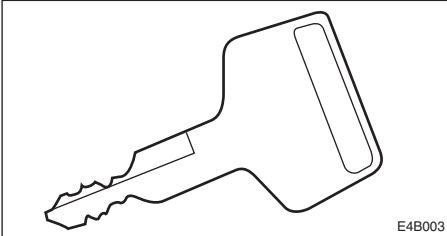

The Ignition key is used not only to start and stop the engine, but also to lock and unlock the following places:

- Fuel filler cap
- Engine hood
- Cab door
- Manual storage

Cab Door < CTL55 >

WARNING

- When mounting and dismounting the cab, first open the door fully to the stopped position and check that it does not move.
- When opening and closing the door, grasp the handle securely and move the door slowly. Opening the door suddenly could result in it hitting your head, or your hands or feet could get caught.

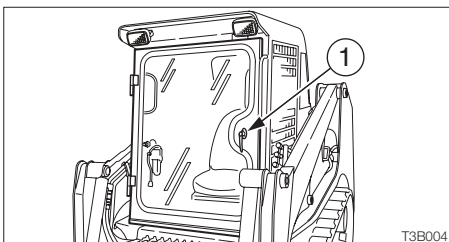

Preparation before Opening and Closing the Cab Door

1. Park the machine on a level surface and stop the engine.
2. Raise the safety bar.

Lock and unlock

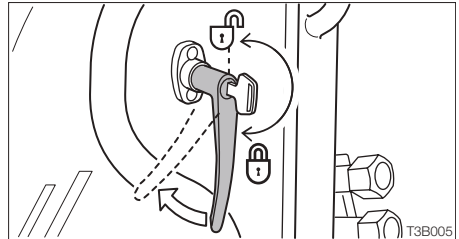

1. Insert and turn the ignition key.

Opening

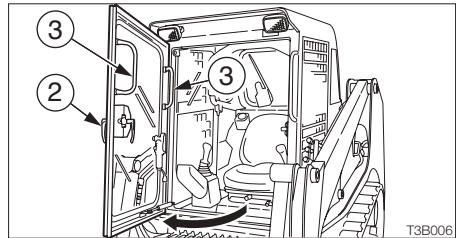

1. Turn the handle (2) clockwise and open the door fully.

To open the door from inside the cab:

1. Turn the handle (2) counterclockwise and open the door fully.

Closing

1. Grasp the handle (2) or (3) and slowly close the door.



Side Window < CTL55 >



1. Grasp the catch (8), unlock it and open the side window.
2. To close the side window, close it until a click is heard.



Engine Hood

WARNING

Before opening the engine hood, be sure to stop the engine. If your hands or tools get caught in the fan or fan belt while the engine is running they may be severely injured.

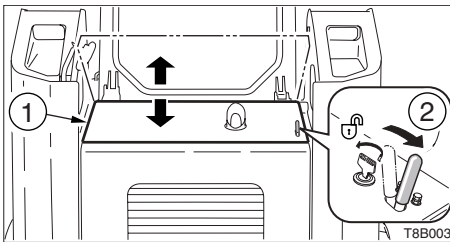

Opening

1. Insert the ignition key and turn it counterclockwise to unlock the engine hood (1).
2. Remove the key and pull the lever (2) backward.
3. Lift the engine hood (1).

Closing

1. Close the engine hood and press it down until a click is heard at the front.
2. Insert the ignition key and turn it clockwise to lock the engine hood.

Rear Door

CAUTION

- When opening the rear door, open it firmly to the locked position.
- When opening and closing the rear door, be careful not to get your hands or other parts of your body caught.

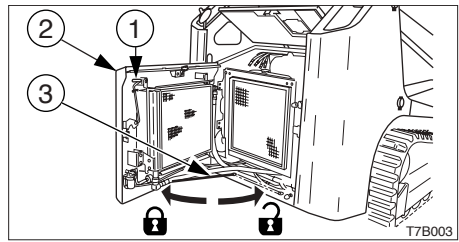

Opening

1. Open the engine hood.
2. Lift the lever (1) and open the rear door (2).
3. Release the stay (3), then insert and secure it into the stay hole of the rear door (2).

Closing

1. Support the rear door (2) by hand, remove stay (3), and secure it in the original position.
2. Close the rear door (2) and press it until a click is heard at the front.



Emergency Exit

If you become trapped inside the cab, remove the rear window to get out.

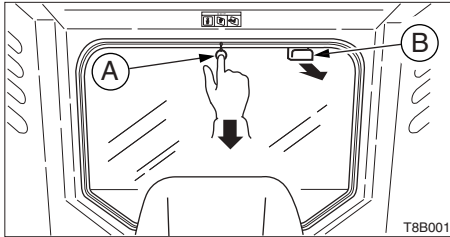

There are two ways to remove the rear window:

— In case of emergency

Kick out the rear window. Note that the glass may break. Be careful not to be injured.

— In case of need

1. Pull off ring (A) and remove the tip of the rubber wedge.
2. Grasp the tip, pull, and remove the entire rubber wedge.
3. Pull inside knob (B).

**Lift Arm Stop****! WARNING**

- If you must work beneath the raised lift arms, securely engage the lift arm stop. Never get under the lift arms and bucket if they are not sufficiently supported.
- Service the lift arm stop if damaged or if parts are missing. Using a damaged lift arm stop or with missing parts can cause the lift arms to drop, causing injury or death.

Maintenance and service work can be done with the lift arms lowered. If the lift arms are raised, use the following procedures to engage and disengage an approved lift arm stop.

Engagement

1. Park the machine on level ground and remove the bucket or attachment.
2. Lower the lift arms to the ground and stop the engine.

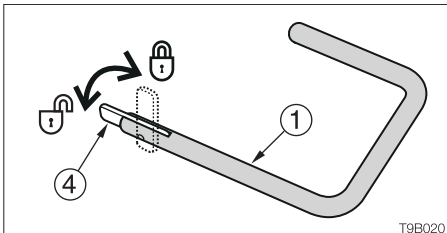
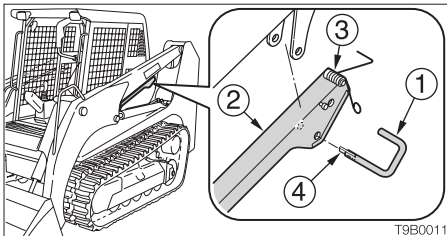

3. Align the hook (4) on the tip of the locking pin (1) with the locking pin.

4. Support the lift arm stop (2) by hand and pull out the locking pin (1).

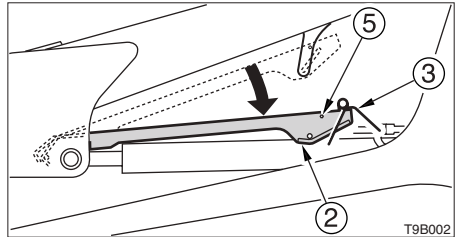

5. Check that the spring (3) moves freely (i.e., is disengaged from the hook (5)) and place the lift arm stop (2) on the cylinder.
6. Sit in the seat, fasten the seat belt, start the engine and lower the safety bar.
7. Raise the lift arms slowly until the lift arm stop (2) drops onto the cylinder rod.

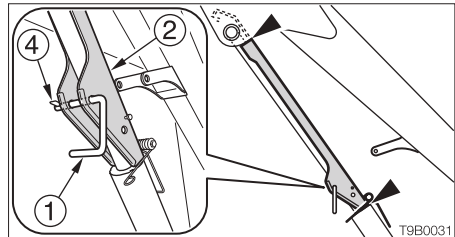

8. Lower the lift arms slowly until the lift arm stop is held between the lift arm and the end of the cylinder tube.
9. Stop the engine.
10. Install the locking pin (1) into the rear of the lift arm stop (2) below the cylinder rod.
11. To prevent the locking pin (1) from falling off, set the hook (4) at a right angle to the locking pin.



Disengagement

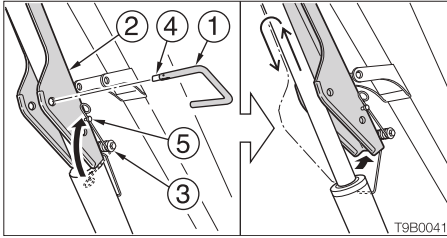

1. Align the hook (4) on the tip of the locking pin (1) with the locking pin.
2. Pull out the locking pin (1) from the lift arm stop (2).
3. Hook the end part of the spring (3) onto the hook (5) of the lift arm stop (2).
4. Sit in the seat, fasten the seat belt, start the engine and lower the safety bar.
5. Raise the lift arms slowly until the spring (3) will lift the lift arm stop (2) off the cylinder rod.
6. Lower the lift arms slowly to the ground and stop the engine.

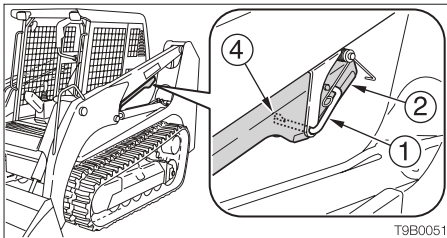

7. Raise the lift arm stop (2) into storage position and insert the locking pin (1) through lift arm stop and bracket.
8. To prevent the locking pin (1) from falling off, set the hook (4) at a right angle to the locking pin.

Fuel Filler Cap

WARNING

- Do not smoke or permit open flames while fueling or near fueling operations.
- Supply fuel in a well ventilated place and with the engine stopped.
- Clean up spilled fuel immediately.
- Do not fill the fuel tank to capacity. Allow room for expansion.
- Tighten the fuel filler cap securely.

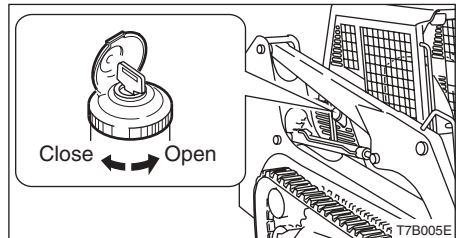

Opening

1. Open the key cover, insert the key and turn it counterclockwise to unlock the fuel cap.
2. Turn the fuel cap counterclockwise and remove it.

Closing

1. Set the fuel cap in place and turn it clockwise.
2. Turn the key clockwise to lock the fuel cap, then remove the key.



Seat < CTL55 >

! WARNING

Adjust, secure and latch the operator's seat.

(A) Seatback angle adjustment

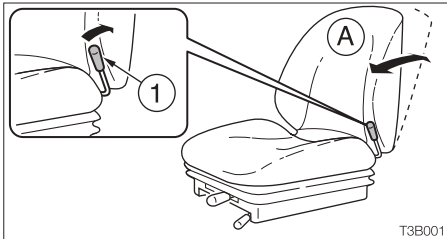

1. Raise your torso, and sit down firmly in the seat.
2. Pull on lever (1) to use the force of the springs in the seatback to adjust the reclining angle. Release the lever (1) at the desired angle and the seatback will be locked in that position.
Adjustment range 15 deg.

(B) Fore-and-aft adjustment

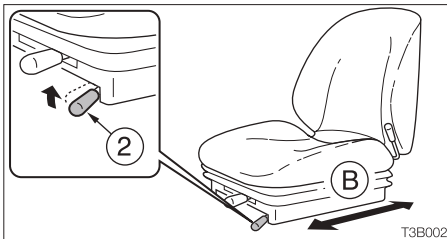

1. Pull on lever (2) and slide the seat rearward or forward to bring it to the optimum position for operating the machine.
2. Release the lever (2) at the desired position and the seat will be locked there.
Adjustment range: 130 mm (5.1 in.)

(C) Weight adjustment

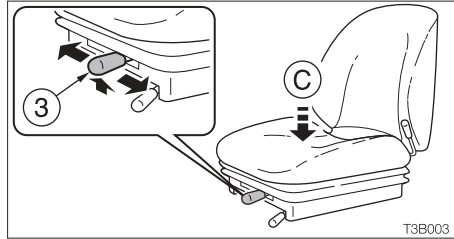

1. Pull on and shift the lever (3) to right side or left side, to adjust the seat suspension according to the operator's weight.
 - RightLight operator
 - MiddleMedium weight operator
 - LeftHeavy operator



Seat Belt < CTL55 >

 CAUTION

Always fasten the seat belt securely before starting the engine.

Fastening the seat belt

1. Adjust the seat to the optimum position for operating, raise your torso, and sit back firmly into the seat.

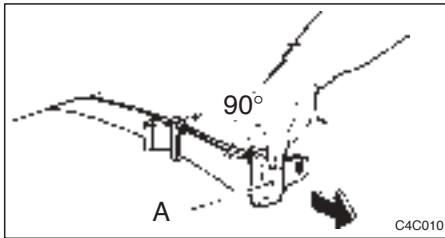

2. Pull on adjuster (A) in the manner shown in the diagram to adjust the seat belt to the desired length.

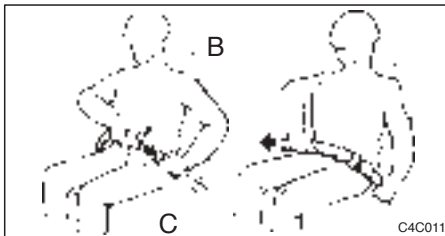

3. Make sure that the belt is not twisted, and then insert the tongue plate (B) into the buckle (C) of the seat belt until you hear a clicking sound as it locks in place.
4. Pull the belt until you can feel the pressure on your pelvis with the belt firmly in place.



Seat < CTL65 / CTL75 / CTL85 >

! WARNING

Adjust, secure and latch the operator's seat.

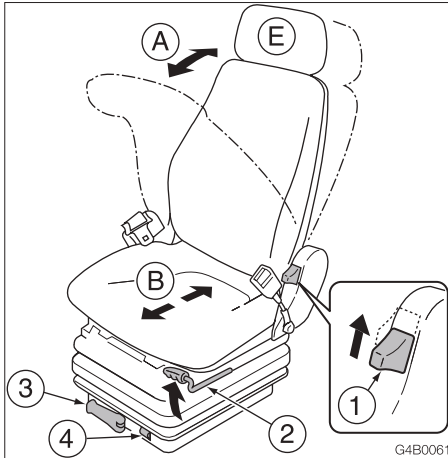
**(A) Seatback angle adjustment****! WARNING**

- Do not set the seat back to its maximum reclining position and slide the seat backwards at the same time. Doing so may break the rear window glass, resulting in injury.
- Be careful not to allow the force of the spring to bring the seat back sharply forward.

1. Raise your torso, and sit down firmly in the seat.
2. Pull on lever (1) to use the force of the springs in the seatback to adjust the reclining angle. Release the lever (1) at the desired angle and the seatback will be locked in that position.

(B) Fore-and-aft adjustment

1. Pull on lever (2) and slide the seat rearward or forward to bring it to the optimum position for operating the machine.
 2. Release the lever (2) at the desired position and the seat will be locked there.
- Adjustment range: 15 steps, 150 mm (5.9 in.)

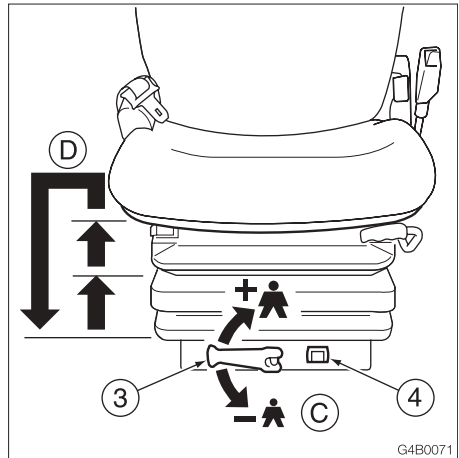
**(C) Weight adjustment**

1. Turn handle (3) until the indicator (4) will show the operator's weight .
May be set to any value 10 kg steps, from 50 to 130 kg (110 to 287 lbs.)

(D) Vertical adjustment

Upward—

Lift the seat to first or second position click-stop.

Downward—

First lift the seat to highest position, then the seat can be lowered to lowest position.

(E) Headrest adjustment (Option)

The position of the headrest can be adjusted in the vertical and front/rear directions.

1. To adjust in the vertical direction, grasp the headrest with both hands and move it upward or downward.
2. To adjust in the front/rear direction, grasp the headrest with both hands and move it forward or rearward.

**Seat Belt < CTL65 / CTL75 / CTL85 >****⚠ CAUTION**

Always fasten the seat belt securely before starting the engine.

Fastening the seat belt

1. Adjust the seat to the optimum position for operating, raise your torso, and sit back firmly into the seat.
2. Pull the seat belt to the desired length.

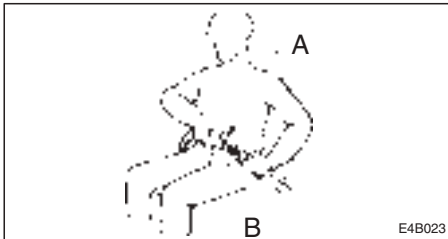

3. Make sure that the belt is not twisted and then insert the tongue plate (A) into the buckle (B) of the seat belt until you hear a clicking sound as it locks in place.

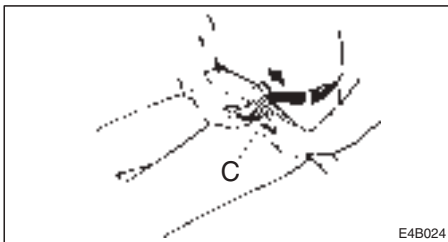
Releasing the seat belt

To remove the seat belt, simply press the button (C) located on the buckle.

The seat belt is automatically retracted.

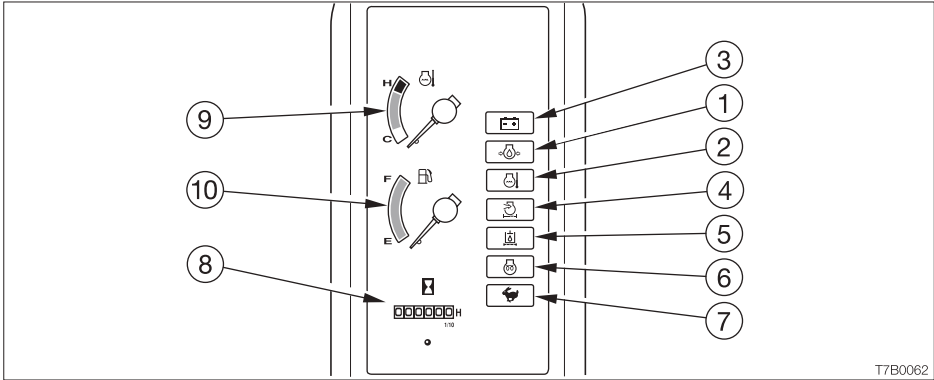

T7B0062

Warning Lamps

IMPORTANT: If a warning lamp flashes and an alarm is sounded, stop all operations immediately and inspect and maintain the appropriate parts.

Refer to page 162, "Troubleshooting."

1. Engine Oil Pressure Warning Lamp



This lamp flashes and an alarm is sounded if the lubricant oil pressure drops abnormally while the engine is running.

2. Coolant Temperature Warning Lamp



This lamp flashes and an alarm is sounded if the engine coolant temperature rises abnormally while the engine is running.

3. Battery Charge Warning Lamp

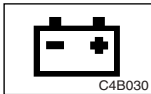

This lamp flashes and an alarm is sounded if a problem arises in the charging system while the engine is running.

4. Air Cleaner Warning Lamp



This lamp flashes and an alarm is sounded if the air cleaner filter is clogged while the engine is running.

5. Pilot Line Filter Warning Lamp



This lamp flashes and an alarm is sounded if the pilot line filter is clogged while the engine is running. This lamp may flash directly after the engine in started in cold weather. This is not a malfunction. The lamp will turn off as the engine warms up.



Indicators

6. Glow Lamp



This lamp turns off when engine preheating is completed.

7. Travel Speed Lamp



This lamp lights when the travel speed button is set to 2nd (high speed).

Meters

8. Hour meter

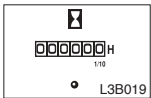

This displays the total engine running time in hours.

The rightmost digit indicates tenths of hours (6 minutes).

Set the inspection and maintenance intervals according to the time displayed on the hour-meter.

9. Coolant Temperature Gauge

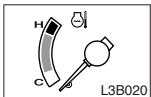

This gauge indicates the temperature of the engine coolant.

The needle should be within the green range during

machine operation.

The red range indicates overheating.

10. Fuel Gauge

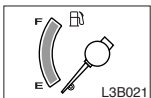

This gauge indicates the amount of fuel in the tank.

Be sure to top off the tank before running out of fuel.

Engine Fault Warning Lamp

< CTL55 / CTL65 / CTL75 >

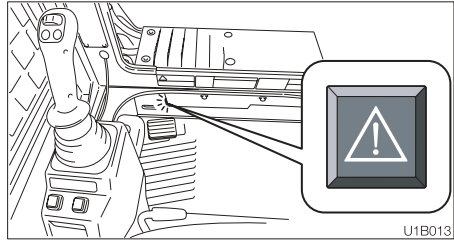

IMPORTANT: If the lamp flashes, check the flashing pattern, stop the engine and then contact a Gehl sales or service outlet for help. Do not run the engine while the lamp is flashing. Otherwise, the specified engine performance cannot be obtained or more serious problem can occur.

When the ignition switch is turned to the ON position, the lamp lights up and stays on for 2 seconds and then goes out.

If a problem arises in the engine or controls, the lamp starts flashing, with the flashing pattern corresponding to the type of problem.



Ignition Switch

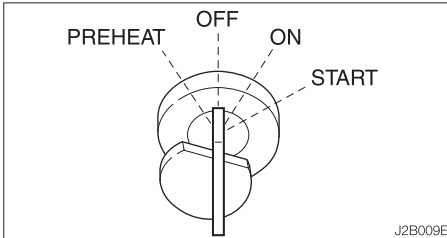

IMPORTANT: Do not repeatedly switch the key from OFF to ON and ON to OFF over a short period. Doing so will cause engine breakdown.

PREHEAT..... Position for preheating the engine.

OFF Position for stopping the engine and inserting and removing the key.

ON..... Position in which the engine is running. In this position, all the electrical equipment is functional.

START Position for starting the engine. When the key is released, the switch automatically returns to the ON position.

Horn Button

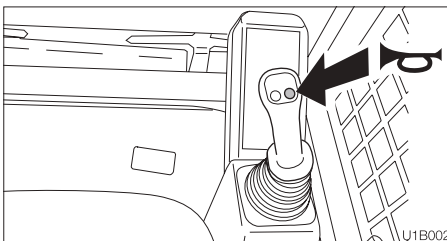

Press the right button on the right control lever to blow the horn.

Float Button

WARNING

- Make sure the bucket is lowered to the ground before putting the lift arms in the Float mode. Putting the lift arms in the Float mode while they are raised will cause the bucket to fall and is extremely dangerous.
- Do not drive the loader forward with the lift arms in the Float mode.

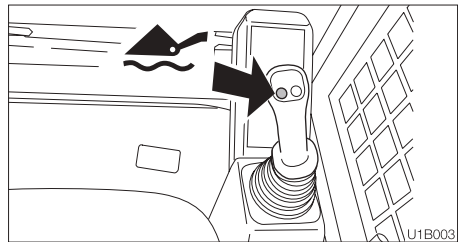

This button sets the lift arms to the Float mode. The lift arms are put to the Float mode while this button is pressed in. When the button is released, the Float mode is canceled.

Setting the arm float to the detent mode

To set to the detent mode, press and hold the arm float button and move the right control lever forward once. To turn off the detent mode, move the right control lever rearward.

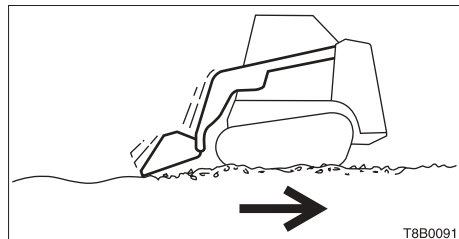

When in the Float mode, the bucket can follow the contour of the ground without movement of the control lever.

MEMO



Auxiliary Hydraulic Switches

Auxiliary Hydraulic Buttons (A), (B)

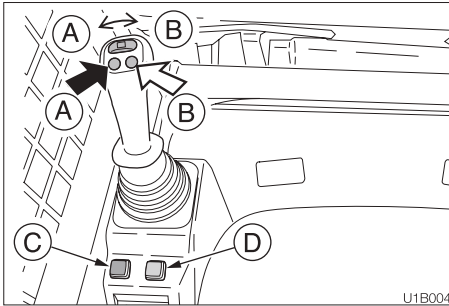

Press these buttons to control the flow of the oil in the auxiliary hydraulic circuit.

- (A).....Hydraulic oil flows to auxiliary hydraulic line (a)
- (B).....Hydraulic oil flows to auxiliary hydraulic line (b)

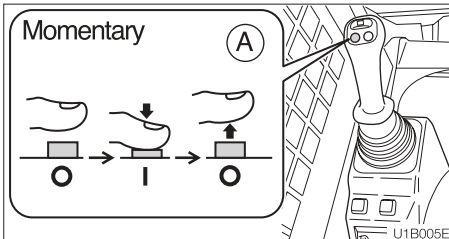

The button turns on the flow when it is pressed, and turns off the flow when it is released.

- When one-way flow is selected by turning on the flow selector switch (C), the auxiliary hydraulic button only functions when button (A) is pressed.
Refer to page 81 "Operating the Auxiliary Hydraulics".

Slider Switch (Proportional control)

Proportional control allows for slow-to-fast movement of auxiliary functions.

Example: If you move the slider switch half way, the auxiliary function will move at approximately one-half speed.

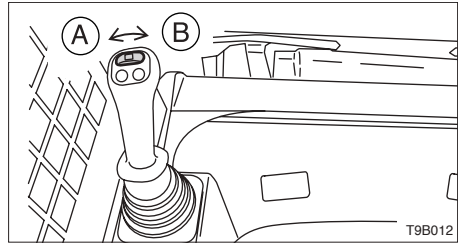

Move this switch to control the flow of the oil in the first auxiliary hydraulic lines.

Flow Selector Switch (C)

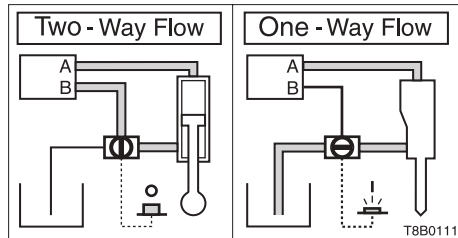
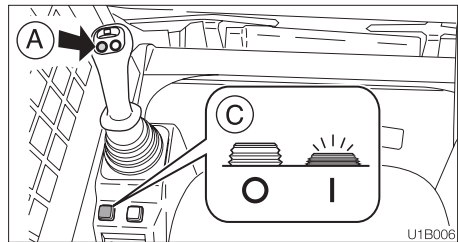

The flow of the auxiliary hydraulic system (lines (a) and (b)) can be set to either one-way or two-way flow. When the switch is pressed, the flow switches from two-way to one-way and the built-in lamp (green) lights. When pressed again, the flow switches from one-way back to two-way and the lamp turns off.

OFF(O)..... Two-way flow

ON (I)..... One-way flow

The oil in line (b) returns to the hydraulic tank.



Detent Mode Switch (D)

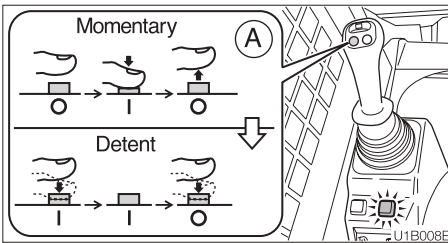
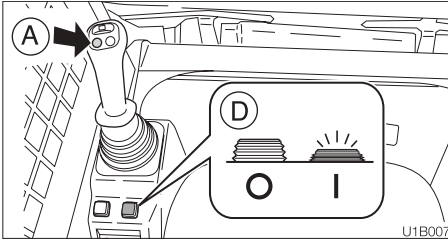

This switch changes the function of auxiliary hydraulic button (A). Normally auxiliary hydraulic flow is on while button (A) is pressed and turns off when it is released. If pressed again after pressing this switch, then auxiliary hydraulic button (A) turns on and stays on when it is pressed, and only turns off when it is pressed again. The built-in lamp (orange) lights when the switch is on. Thus there is no need to hold the switch in. When this switch is pressed again, the function of the auxiliary hydraulic switch returns to normal and the lamp turns off.

High-Flow Switch (E) - (If equipped)

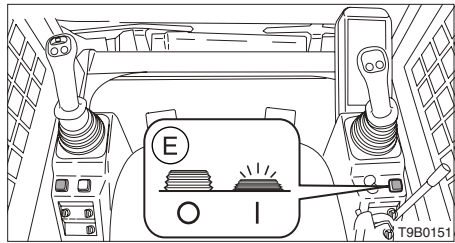

This switch controls the ON / OFF function of the high-flow auxiliary hydraulics.

Press this switch to activate the high-flow hydraulics and the hydraulic flow switches from two-way to one-way and the built-in lamp and flow selector switch lamp (green) come on. Press this switch again to deactivate the high-flow hydraulics and the hydraulic flow switches from one-way back to two-way and the lamps go out.

Refer to page 63, "High-Flow Hydraulic System".

O..... OFF

I..... ON



CONTROLS Switches

Travel Speed Button

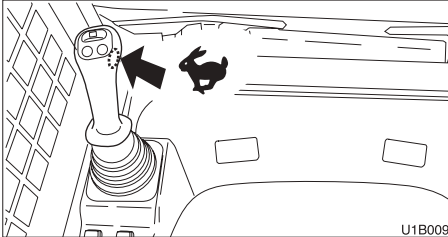

Press this button to set the travel speed to 2nd speed (high speed) while travel speed lamp lights. Press again to return to 1st speed (low speed) and travel speed lamp turns off.

Travel speed always begins in 1st speed when starting the engine.

Refer to page 53, "Travel Speed Lamp."

Light Switches

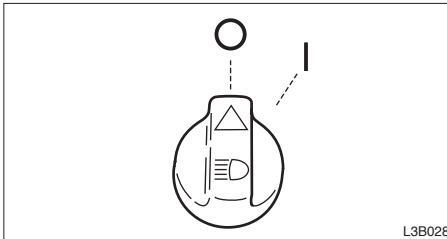

When this switch is turned on while the ignition switch is ON, the lights turn on as follows:

Front light switch

O..... Off

I..... Instrument lights and front lights turn on.

Tail light switch

O..... Off

I..... Tail lights turn on.

Wiper Switches (Option)

IMPORTANT: If no washer fluid is discharged, do not operate the washer. Doing so may damage the pump.

IMPORTANT: Operating the wiper with no moisture on the windshield will scratch the glass. Apply water or washer fluid when operating the wiper.

IMPORTANT: In cold seasons, the wiper blade may freeze to the glass. Operating the wiper forcibly may damage the wiper motor.

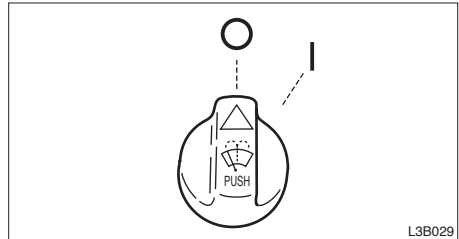

Front wiper switch

O..... Off

I..... Wiper operates.

PUSH..... Washer fluid is squirted from the nozzle while pressed, and stops when released.

Rear wiper switch

O..... Off

I..... Wiper operates.

PUSH..... Washer fluid is squirted from the nozzle while pressed, and stops when released.



Safety Bar

WARNING

- Before leaving the operator's seat, raise the safety bar to engage the lock and stop the engine. If any controls are touched accidentally when the safety bar is lowered, the machine will move suddenly, and cause serious injury or death.
- Be careful not to touch the control levers and pedal when lowering or raising the safety bar.

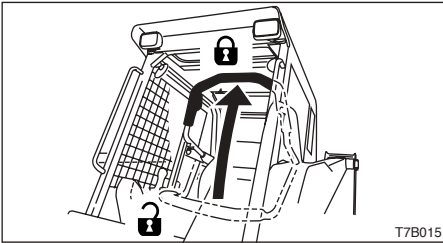

This device is for locking the control levers, pedal and selector, detent mode and high-flow switches.

When the safety bar is lifted, the levers, pedal and switches are locked.

Throttle Lever

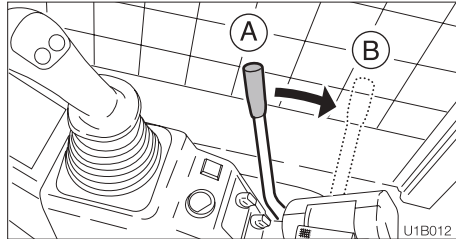

This lever controls the engine speed.

- (A) Low idle
- (B) Maximum speed

Throttle Pedal

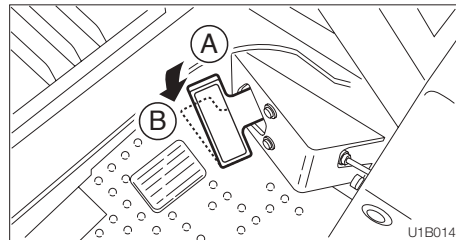

This pedal controls the engine speed.

- (A) Low idle
- (B) Maximum speed



CONTROLS

Levers and Pedals

Right Control Lever

WARNING

Be sure to check which pattern of lever control arrangement you are operating with before beginning operations.

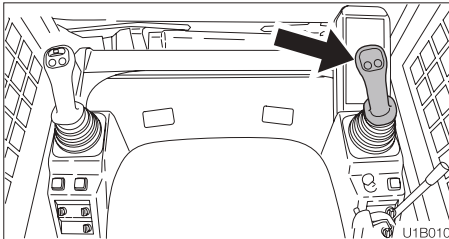

Use this lever to operate the lift arms and bucket.

Refer to page 74, "Lever Pattern."

Refer to page 80, "Operating the Right Control Lever."

Left Control Lever

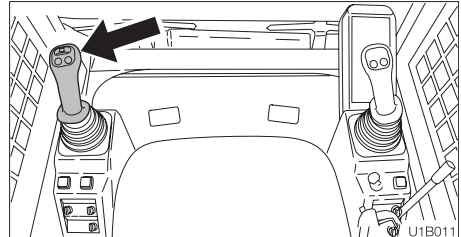

Use this lever to move forward and rearward and to change directions.

Refer to page 74, "Lever Pattern."

Refer to page 77, "Operating the Left Control Lever."



Interior Light (Option)

IMPORTANT: The battery charge will decrease if the interior light is left on for long periods of time with the engine stopped. Turn the light off when leaving the machine.

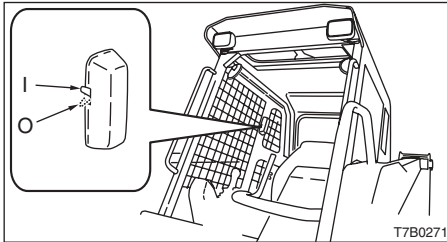

O.....Off

I.....On



Auxiliary Hydraulic Lines

! WARNING

- **Oil may spray out if caps or filters are removed or pipes disconnected before releasing the pressure in the hydraulic system.**
 - **When removing plugs or disconnecting hoses, release the internal pressure before removing.**
- **Hydraulic fluid, tubes, fittings and quick couplers can get hot when running machine and attachments.**
Be careful when connecting and disconnecting quick couplers.

These lines deliver the hydraulic oil necessary for operating other attachments.

- Auxiliary hydraulic flow rate and rated pressure:
Flow Rate
 CTL55: 57 L/min (15.1 US gpm)
 CTL65: 70 L/min (18.4 US gpm)
 CTL75: 75 L/min (19.8 US gpm)
 CTL85: 89 L/min (23.4 US gpm)
 Rated Pressure 20.6 MPa (2987 psi)

Quick-Couplers

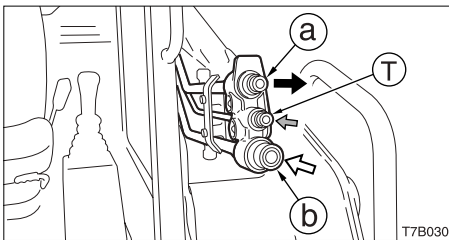

Connecting: Remove dirt or debris from the surface of both the male and female couplers, and from the outside diameter of the male coupler. Visually check the couplers for corrosion, cracks, damage or excessive wear. If any of these conditions exist, the coupler(s) must be replaced.

Install the male coupler into the female coupler. Full connection is made when the ball-release sleeve slides forward on the female coupler.

Disconnecting: Hold the male coupler. Retract the sleeve on the female coupler until the couplers disconnect.

Releasing Residual Pressure

Connecting: Push the quick-couplers tightly together and hold for five seconds; the pressure is automatically released as the couplers are installed.

Disconnecting: Push the quick-couplers tightly together and hold for five seconds; then retract the sleeve until the couplers disconnect.

Connecting the Hydraulic Circuits

To connect attachment hydraulic lines, use the following procedures:

1. Connect the attachment hydraulic lines to ports (a) and (b).

When fitted with a hydraulic breaker:

- a. Connect the return circuit to port (b) and the supply circuit to port (a).
- b. Turn on the flow selector switch.

Refer to page 56 "Flow Selector Switch."

Some attachments may have a case drain, which needs to be connected to the small port (T).

2. When connecting is complete, purge air from the hydraulic lines.
 - a. Start and run the engine at low idle with no load for 10 minutes.
 - b. With the engine running at low idle, operate the auxiliary hydraulics switch repeatedly (approx. 10 times) to purge air from the hydraulic lines.
 - c. Stop the engine and wait for more than 5 minutes until bubbles escape from the hydraulic oil in the tank.



IMPORTANT: Follow the procedures for purging air as instructed by the attachment manufacturer if specified to do so.

3. Check for leaks.

High-flow Hydraulic System (If Equipped)

The High-flow function provides additional flow to the system to operate attachments that require more hydraulic flow (EXAMPLE: Cold planer).

This system can be used only for one-way flow attachments.

- Auxiliary hydraulic flow rate and rated pressure:

Flow Rate

CTL75: 138 L/min (36.3 US gpm)

CTL85: 152 L/min (40.1 US gpm)

Rated Pressure20.6MPa (2987 psi)

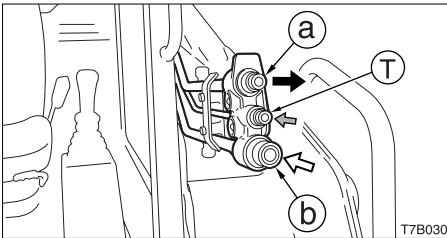

1. Connect the attachment hydraulic lines to ports (a) and (b).

Refer to page 62, “Connecting the Hydraulic Circuits”.

Some attachments may have a case drain, which need to be connected to the small port (T).

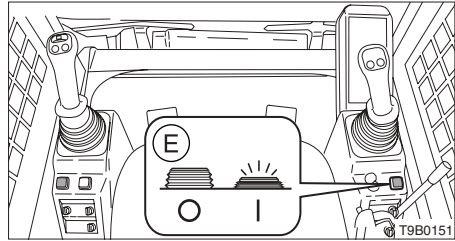

2. Turn on the High-Flow switch (E) (green light is ON).

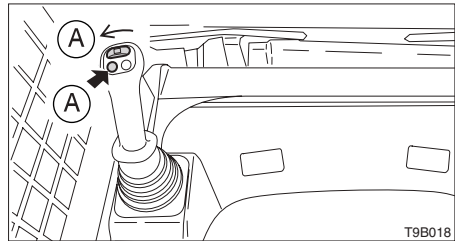

3. Press the auxiliary hydraulic switch (A) or slide the slider switch to the left side (A). Refer to page 81, “Operating the Auxiliary Hydraulics”.

Note: Running the high flow hydraulics for extended periods of time could cause damage to the hydraulics or other systems of the machine due to overheating.

To prevent overheating and reduce the risk of fire, the machine should be cleaned daily. The standard cooling package is not permitted for use in high airborne debris applications such as mulching or land clearing.

Operating attachments in these environments could cause the warranty to be denied.

IMPORTANT: Operation over long periods with Detent mode switch pressed will cause the hydraulic oil temperature to rise and will shorten the life of the hydraulic units.

MEMO

MEMO

MEMO

MEMO



OPERATION

Before Starting Operation	70
Starting and Stopping the Engine	71
Machine Operation	74
Operating Procedures	82
Parking the Machine	90
Operating in Cold Weather	91
Using Rubber Tracks	92



Mounting and Dismounting

WARNING

- **Do not jump on or off the machine. Never attempt to mount or dismount a moving machine.**
- **When mounting and dismounting the cab, first open the door fully to the locked position and check that it does not move (for machines with front door).**

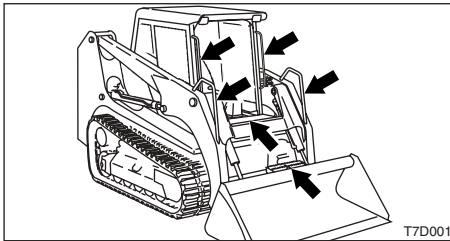

- **Always face the access system and maintain a three-point contact with the handholds and steps while getting on and off the machine. Keep steps and platform clean.**
- **Never use the control levers as hand holds.**

Walk-Around Inspection

Perform the walk-around inspection before starting the engine the first time each day. Perform the inspection as described under “Maintenance - Walk-Around Inspection” (pages 114 and 115).

Daily Inspection

Perform the daily inspection once a day before starting the engine the first time each day. Perform the inspection as described under “Maintenance - Daily Inspection” (pages 116 to 120).



Before Starting the Engine

1. Adjust the seat for a comfortable operating position.
2. Fasten the seat belt.

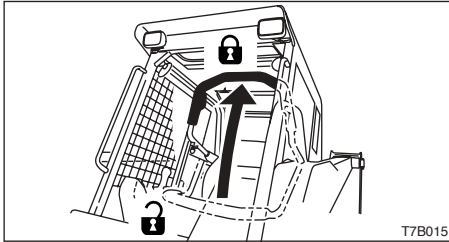

3. Check that the safety bar is in the locked position.

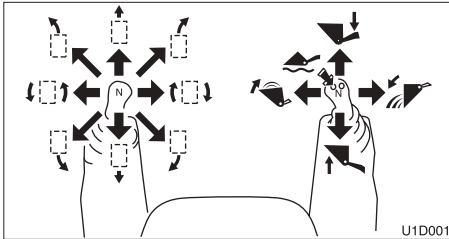

4. Check that the control levers and pedal are in the neutral position.

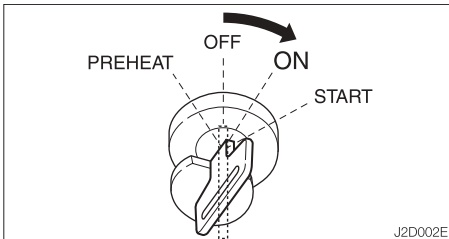

5. Insert the key into the ignition switch, turn it to the ON position, then perform the following inspection:

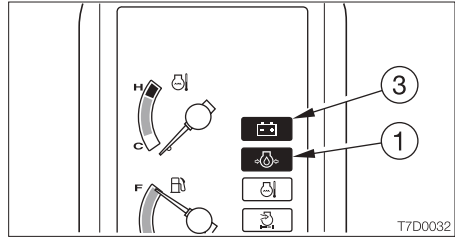

- All the warning lamps flash and an alarm is sounded for 2 seconds. The instruments also start functioning. After 2 seconds, only the battery charge warning lamp (3) and engine oil pressure warning lamp (1) flash, and the other lamps turn off.
- Turn the light switch to check that the front lights, tail lights and instruments lights turn on.
- Check the fuel level.

If a lamp does not light or the alarm is not sounded, the bulb may be burned out or a wire may be damaged. Contact a Gehl dealer for repairs.



Starting the Engine

WARNING

- Clear the area of all persons.
- Sound horn to alert everyone around the machine.

IMPORTANT: Do not run the starter motor for more than 15 consecutive seconds. If the engine fails to start, wait for 30 seconds to protect the battery, and then try again to start the engine.

Normal Starting

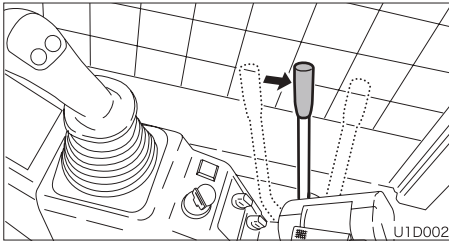

1. Pull the throttle lever to the middle position.

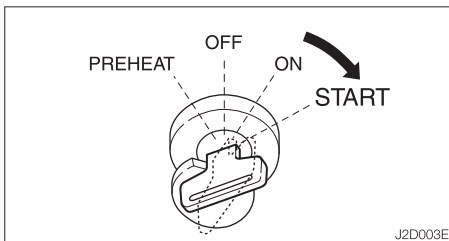

2. Turn the key to the START position and start the engine.
3. Once the engine starts, release the key. The key automatically returns to the ON position.
4. Check that the warning lamps are off.
5. Return the throttle lever to idle position and warm up the engine. Refer to page 73, "Warming Up the Engine."

Starting in Cold Weather

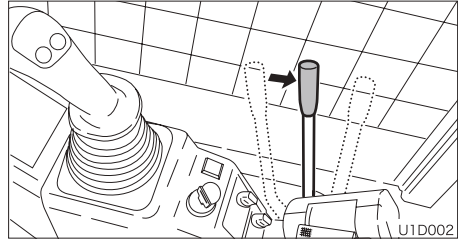

1. Pull the throttle lever to the middle position.

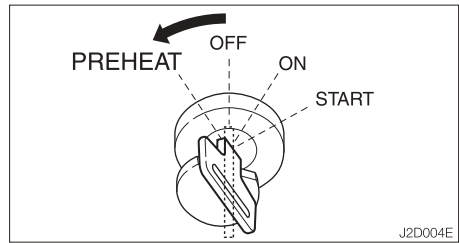

2. Turn the key to the PREHEAT position and hold it there while the glow lamp is lit (about 15 seconds /CTL85: 25 seconds).
3. After the glow lamp turns off, then turn the key to the START position and start the engine.
4. Once the engine starts, release the key. The key automatically returns to the ON position.
5. Check that the warning lamps are off.
6. Return the throttle lever to idle position and warm up the engine. Refer to page 73, "Warming Up the Engine."



Warming Up the Engine

IMPORTANT: Avoid racing the engine until it is warmed up.
Do not warm up the engine for long periods of time (20 minutes or more).

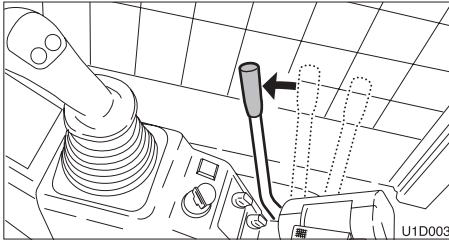

1. Return the throttle lever to idle position, and idle the engine for about 5 minutes with no load.

Stopping the Engine

IMPORTANT: Do not stop the engine suddenly when operating with heavy loads or at maximum speed. Doing so may cause the engine to overheat or seize. Never bring the engine to a sudden stop except in the case of a true emergency.

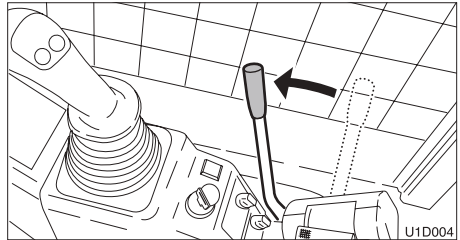

1. Idle the engine for about 5 minutes to gradually let it cool.

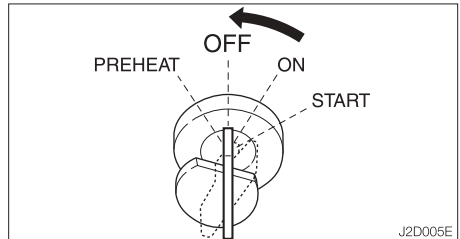

2. Turn the key to the OFF position to stop the engine.



Lever Pattern

WARNING

- Be careful to check which pattern of lever control arrangement you are operating with before beginning operations.

The explanations in this manual are for this pattern.

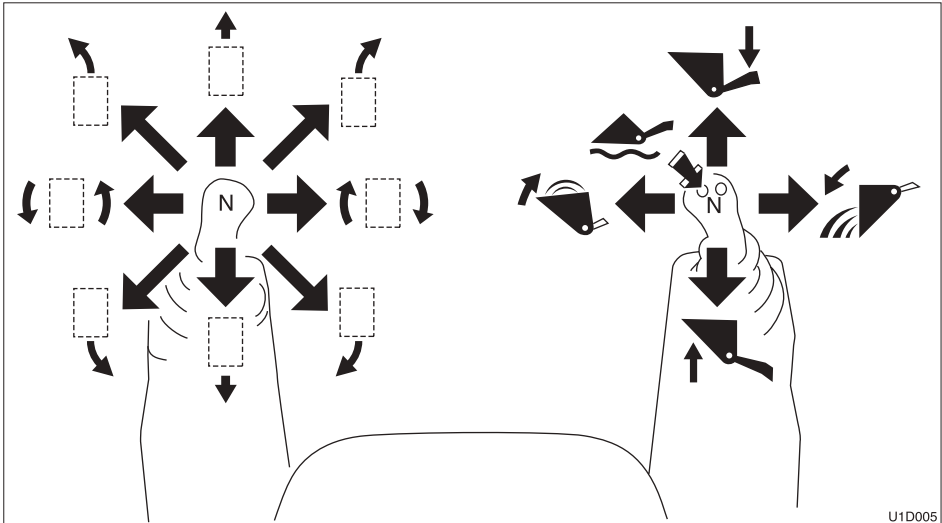

U1D005

	Crawler Forward		Lift Arm Lower
	Crawler Reverse		Lift Arm Raise
	Left Spin Turn		Bucket Rollback
	Right Spin Turn		Bucket Dump
	Left Pivot Turn		Lift Arm Float
	Right Pivot Turn	N	Neutral
	Right Pivot Turn Reverse		
	Left Pivot Turn Reverse		



Warming Up the Hydraulics

! WARNING

Operating the working equipment without warming up the hydraulics is dangerous, because response will be slow and the equipment may move in unexpected ways. Be sure to sufficiently warm up the hydraulics.

IMPORTANT: Do not operate the levers suddenly when the hydraulic oil temperature is below 20°C (68°F). The proper hydraulic oil temperature during operation is 50 to 80°C (122 to 176°F), but if operations must be performed at lower temperatures, heat up the hydraulic oil to at least 20°C (68°F).

Normal Warm-up

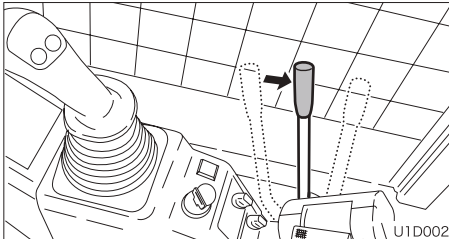

1. Run the engine at medium speed for about 5 minutes with no load.

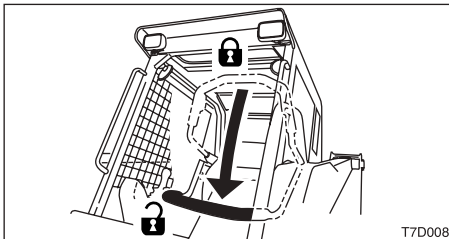

2. Set the safety bar to the released position and lift the bucket from the ground.

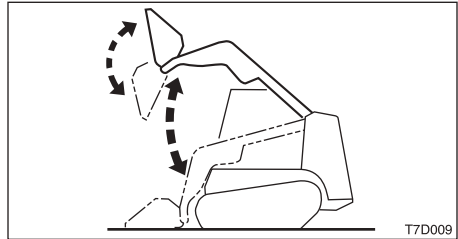

3. Extend and retract each of the cylinders several times with no load.

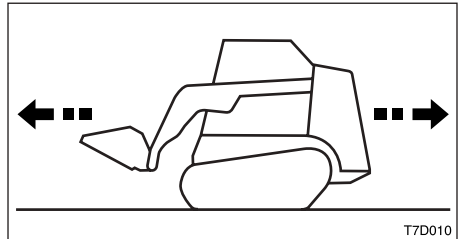

4. Travel slowly forward and backward several times.

Warming Up in Cold Weather

1. Perform the normal warm-up procedure.

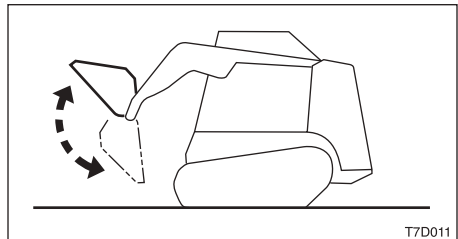

2. Set the bucket cylinder at the stroke end and keep it there.
Do not do this for more than 30 seconds.
3. Repeat step 2 until the bucket operating speed is normal.



Inspection After Warm-up

After warming up the engine and hydraulic oil, perform the checks and inspections described below, and repair if there is a problem.

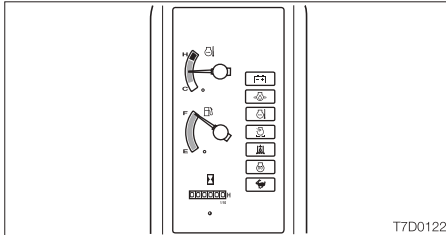

1. Check that the warning lamps and instruments are as follows:
 - Are all the warning lamps off?
 - Is the water temperature gauge needle within the green range?
2. Check that there are no irregularities in the exhaust color, sound and vibrations.

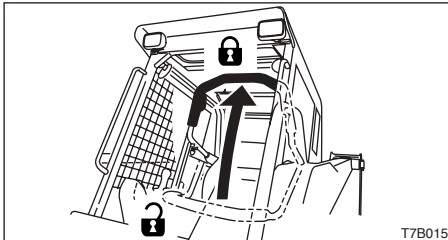

3. Set the safety bar to the locked position and check that the control levers and pedal are locked.



Operating the Left Control Lever

! WARNING

- Never allow anyone to enter the turning radius and machine path.
- Signal your intention to move by sounding the horn.
- Traveling and turning should be performed with the bucket cylinder fully retracted and the bucket at a height of approximately 30 cm (12 in.) from the ground.
- Avoid sudden stops, start or turns.
- Do not raise the safety bar while traveling. This is dangerous, because raising the safety bar will cause the parking brakes of the travel motors to operate and apply the brakes abruptly.
- Do not switch off the ignition switch while traveling. Doing so will cause sudden braking and is dangerous.
- Before backing up, visually check for safety to the rear. Backing up without checking could result in contact with a worker or obstacle.
- If unavoidable while traveling, when operating the working equipment, do so with care.
- Avoid crossing over obstacles whenever possible. If you must do so, keep the bucket close to the ground and travel slowly. Never cross obstacles if they will seriously tilt the machine (to an angle of 15° or greater).
- When traveling on rough terrain or when carrying a load, lower the load and travel slowly.
- Remove any obstacles in the machine's path.

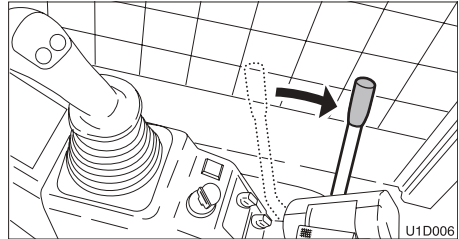

1. Increase the engine speed.

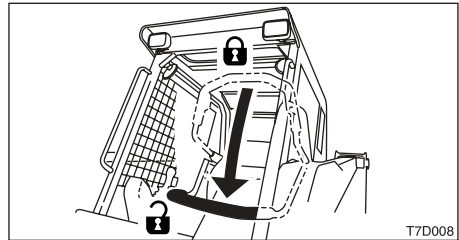

2. Set the safety bar to the released position.

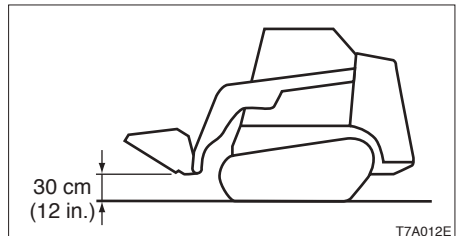

3. Roll back the bucket fully and lift the bucket to 30 cm (12 in.) above the ground.

Use the left control lever to operate the crawler tracks.

Return the left control lever to the neutral position to stop the tracks.



Forward and Reverse Travel

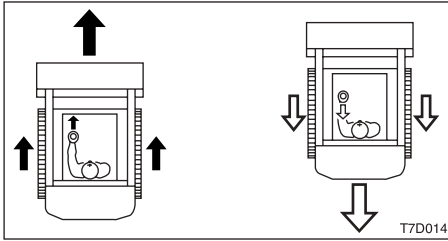

- ➔ To move forward:
Push the left control lever forward.
- ⇨ To move backward:
Pull the left control lever rearward.

Traveling in 2nd (High) Speed

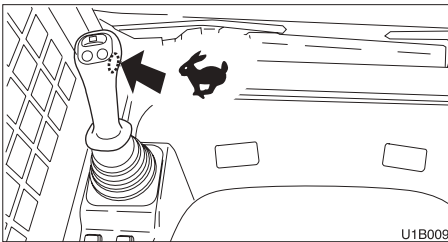

Press the travel speed button on the left control lever to switch to 2nd (high) speed, and press it again to return to 1st speed (low speed).

Pivot Turn

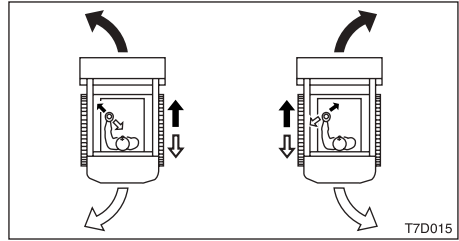

- Turning to the left:
 - ➔ To turn forward to the left:
Tilt the left control lever forward to the left.
 - ⇨ To turn rearward to the left:
Tilt the left control lever rearward to the right.
- To turn to the right, operate the left control lever in the opposite way.

Spin Turn

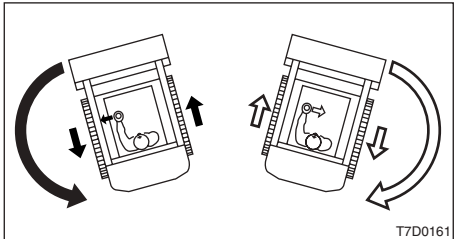

- ➔ To spin left:
Tilt the left control lever to the left.
- ⇨ To spin right:
Tilt the left control lever to the right.



Stopping Travel

WARNING

- Park the machine on firm, level ground and apply the parking brake. If you must park on a slope or incline, park across the slope and block the machine securely to prevent movement.
- If any controls are touched accidentally when the safety bar is lowered, the machine will move suddenly, and may cause serious injury or death.

CAUTION

Never bring the machine to a sudden stop except in the case of a true emergency. Stop as gently as possible.

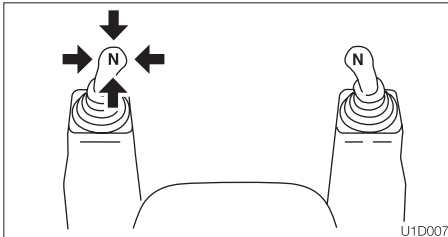

1. Slowly set the left control lever to the neutral position. The machine stops. Braking is automatically applied by the hydrostatic drive system when the left control lever is returned to the neutral position. Full braking is achieved when the safety bar is raised.



Operating the Right Control Lever

! WARNING

- Be careful to check which pattern of lever control arrangement you are operating with before beginning operations.
- Make sure the bucket is lowered to the ground before floating the lift arms. Floating the lift arms while they are raised will cause the bucket to fall rapidly and is extremely dangerous.
- Do not drive the loader forward with the lift arms in Float position.
- At times of combined operation of bucket and lowering, tilting the lift arms, continuation of the combined operation after the bucket cylinder has reached fall stroke will result in the lift arms rising or stopping without going lower. Be cautious of any unexpected movement of the lift arms.

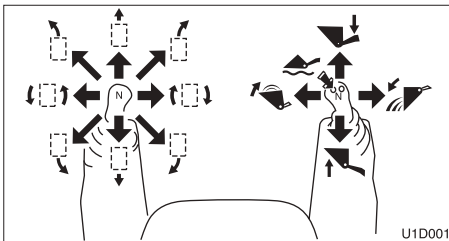

U1D001

Use the right control lever to operate the lift arms and bucket.

Return the right control lever to the neutral position to stop the lift arms and bucket.

Set the safety bar to the released position.

Operating the Lift Arms

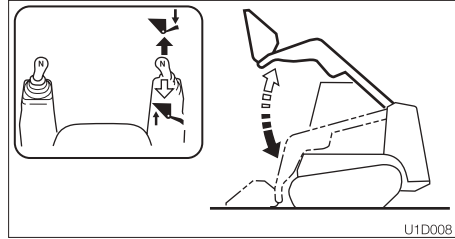

U1D008

- ➔ To lower the lift arms:
Push the right control lever forward.
- ⇨ To raise the lift arms:
Pull the right control lever rearward.

Operating the Bucket

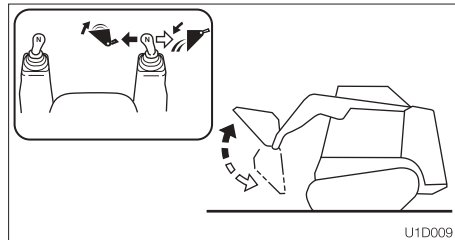

U1D009

- ➔ To roll back:
Tilt the right control lever to the left.
- ⇨ To dump:
Tilt the right control lever to the right.

Operating the Lift Arms Float

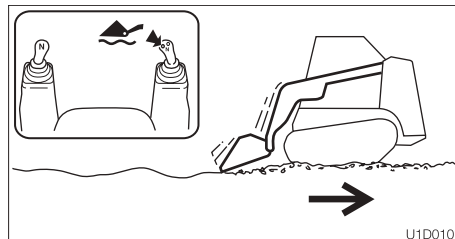

U1D010

- ➔ To float the lift arms:
Press the float switch on the right control lever.



Operating the Auxiliary Hydraulics

Use the auxiliary hydraulics to operate a breaker, angle bucket or other approved attachments.

Two methods of operation are permitted: operation with the auxiliary hydraulic buttons, and operation with the slider switch.

Operating the Auxiliary Hydraulic Switches

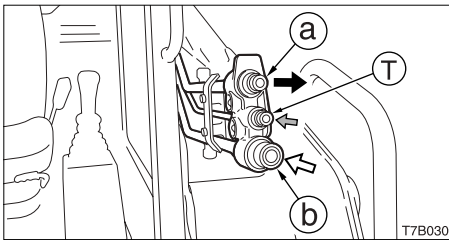
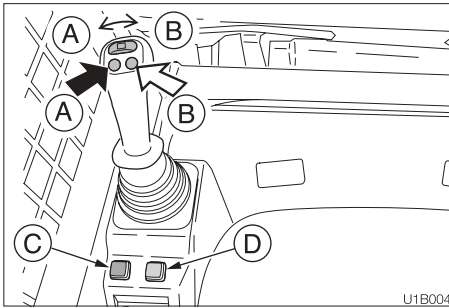

- ➔ To deliver hydraulic oil to port (a):
Depress (A).
 - When using a hydraulic breaker or other one-way flow attachment.
- ⇨ To deliver hydraulic oil to port (b):
Depress (B).

When using a hydraulic breaker or other 1-way flow attachment:

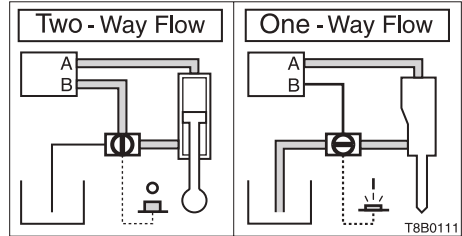

Change the direction of the hydraulic oil flow by setting flow selector switch (C) ON to return the oil in the (b) port line directly to the hydraulic tank.

Refer to page 56, “Flow Selector Switch.”

When using detent mode switch (D):

IMPORTANT: Operation over long periods with Detent mode switch pressed will cause the hydraulic oil temperature to rise and will shorten the life of the hydraulic units.

Pressing the detent mode switch (D) lights the orange lamp and the auxiliary hydraulic switch (A) changes to detent mode.

Detent mode

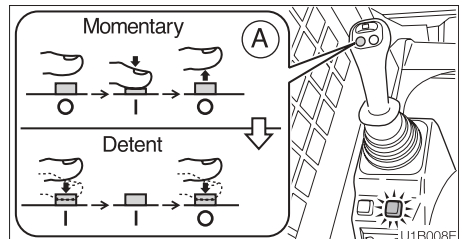

One press of the auxiliary hydraulic switch (A) sets it to ON, and one more press sets it to OFF. There is no need to continue pressing the switch.

Refer to page 57, “Detent Mode Switch.”

Operating the High-Flow Hydraulics

Refer to page 63, “High-Flow Hydraulic System.”



Prohibited Operations

WARNING

- Do not operate on base rock (hard or soft).
- If you must operate the lift arms and bucket while traveling, operate at speeds slow enough so you have complete control at all times.

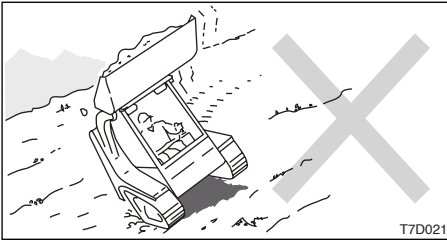

- Work should not be performed on a slope, because the stability of the machine can be reduced when operating the working equipment and there is the danger of the machine tipping over.

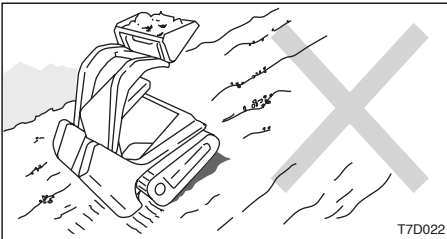

- Keep the bucket as low as possible during travel. Do not travel or attempt to change directions with the bucket raised.

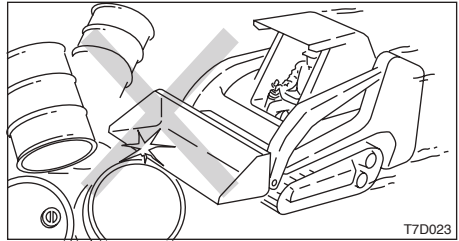

- Travel at a speed that is appropriate for the conditions. Travel at low speeds when the field of view is obstructed, and take extra precautions with hazardous materials.

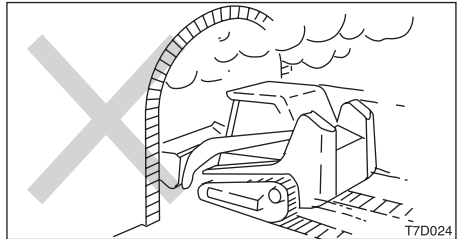

- Do not use this loader in areas where there is danger of explosion from volatile gases. Also avoid using the loader where the exhaust gases could come in contact with flammable items.

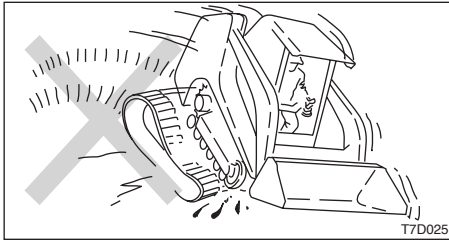

- Do not attempt a spin turn or pivot turn at high speeds. Doing so may cause extreme wear and/or the tracks to come off.

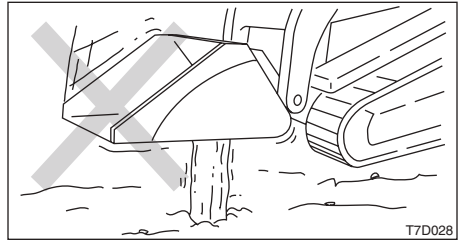

- Do not use the downward force of the bucket to drive piles.

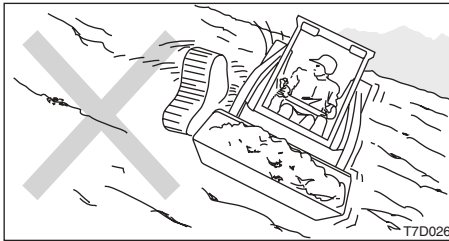

- Do not cut across a slope. Doing so may cause extreme wear and/or the tracks to come off.

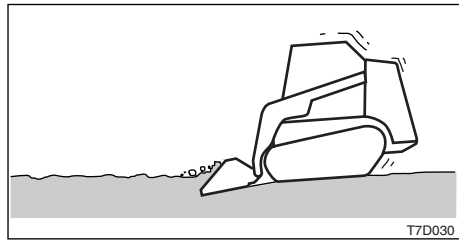

- Do not dig down deeply with the bucket. Doing so could damage the bucket and lift arms.

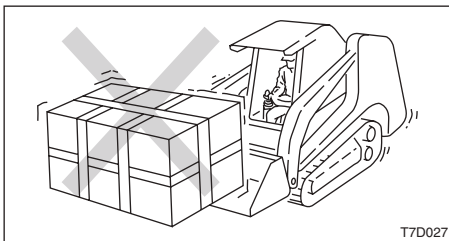

- Do not exceed the loader's rated operating capacity.
- Do not use buckets or attachments that exceed the loader's operating capacity.

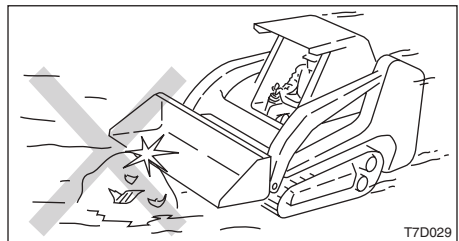

- Hitting the bucket against rocks, etc., could damage the bucket or the bucket cylinders.

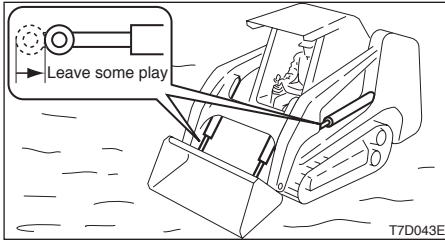

- Do not conduct operations with the cylinders fully extended or retracted. Doing so applies excessive force on the cylinders and may damage them.

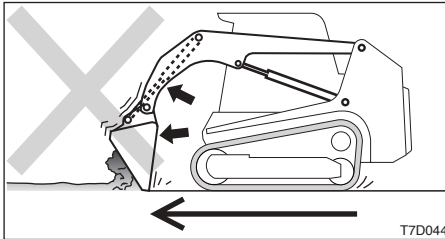

- Do not perform scooping or grading operations with the bucket cylinders fully extended. The traction force will apply extremely heavy loads on the bucket cylinders and this may damage them.

Cautions on Operating

Cautions on Traveling

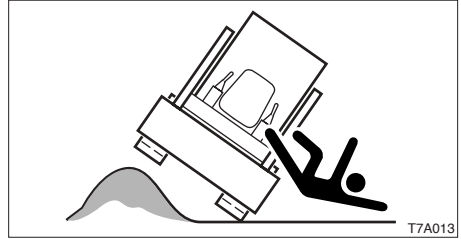

Traveling over obstacles (rocks, stumps, etc.) may subject the machine to strong shocks and result in damage. Avoid traveling over obstacles whenever possible. If you must do so, keep the bucket near the ground, travel at low speed, and go over the obstacle at the center of the crawler.

Cautions on Traveling in 2nd (High) Speed

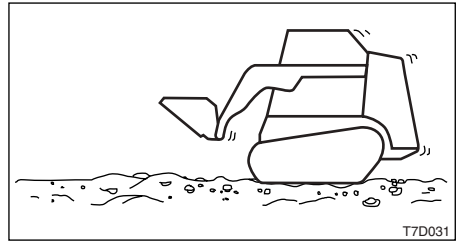

On uneven ground, travel at low speeds and avoid accelerating, stopping or changing directions abruptly.

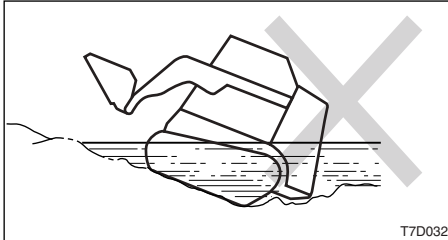
**Cautions on Use in Water**

If you leave water at a sharp angle, the rear of the machine may be submerged, exposing the radiator fan to water and damaging it. Do not let the rear of the machine become submerged.

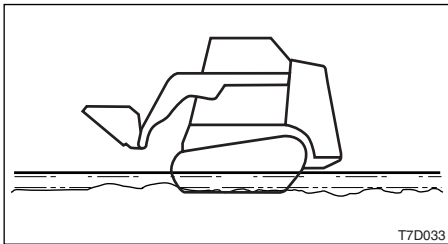

- Allowable water depth
In water, only use the machine up to a depth at which the water comes up to the bottom of the chassis.
- When greasing places used under water for long periods of time, apply enough grease so that the old grease is expelled.
- Never submerge the main chassis in water or sand. If the main chassis becomes submerged, contact a Gehl dealer for inspection.



Cautions on Traveling on Slopes

WARNING

- Never exceed the machine's stability capabilities (maximum gradeability - 30°, lateral tipping angle - 15°). Also note that when actual working area conditions are poor the machine's stability capabilities may be lower.
- When traveling on slopes or grades, lower the bucket to a height of 20 to 30 cm (8 to 12 in.) off the ground. In emergencies, lower the bucket to the ground and stop the machine.
- Travel at slow speeds on slopes. Especially when going down slopes, reduce the engine (r.p.m.) speed and set the position of the left control lever to half or less before going down. Going down a slope too fast will lead to loss of control.
- When going up or down slopes having a gradient of 15 degrees or more, travel up and down slope with the heavy end of the machine pointed up hill.
- When traveling on a slope, be cautious of tipping over or sliding sideways.
- Do not travel down slopes in reverse (except for with bucket full).

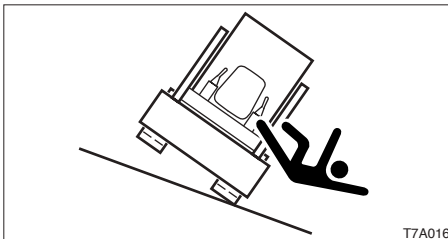

- Do not change directions or cross slopes sideways. First return to a flat surface, then redirect the machine.

- On grass, dead leaves, wet metal or frozen surfaces, the machine may slide sideways even on very gentle slopes. Make sure the machine is never sideways with respect to the slope.

Position for traveling on slopes

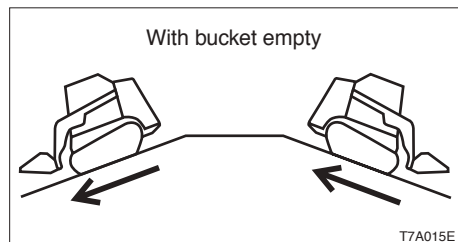
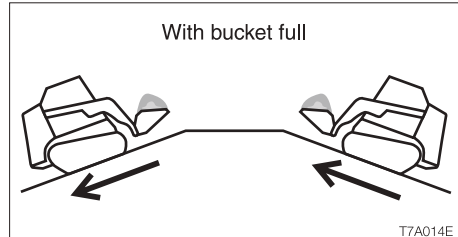



Braking when traveling down slopes

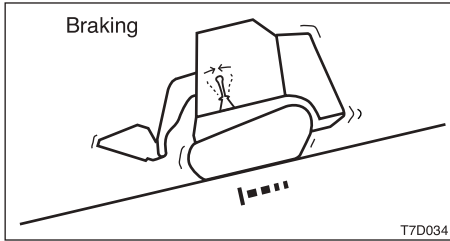

Braking is automatically applied by the hydrostatic drive system when the left control lever is returned to the neutral position. Full braking is achieved when the safety bar is raised.

If the engine stops

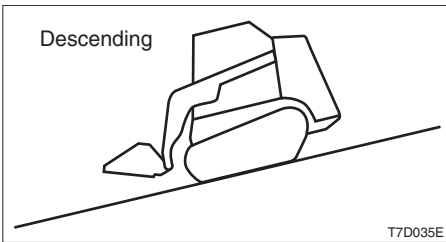

If the engine stops when traveling down a slope, set the control levers and pedal to the neutral position, stop the machine and restart the engine.

Do not open the front door while traveling on slopes (if equipped)



Opening the front door while traveling on slopes can be hazardous, because the force required to open and close the door changes abruptly. Always keep the door closed when traveling on slopes.



Operations Possible with this Machine

IMPORTANT: Do not perform scooping or grading operations with the bucket cylinders fully extended. The traction force will apply extremely heavy loads on the bucket cylinders and this may damage them.

Scooping

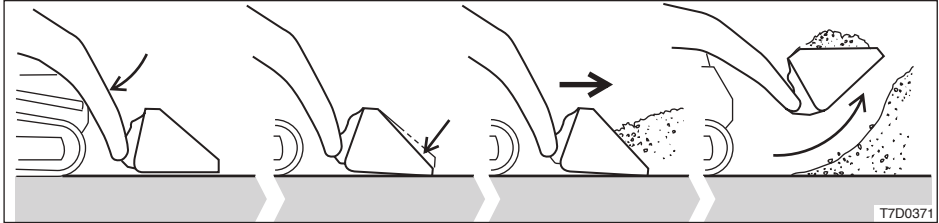

Lower the lift arms and bring the bucket down to the ground with the front end tilted slightly forward, then drive the loader forward until the bucket is filled with the material. Next tilt the bucket rearward and scoop up the material.

Grading

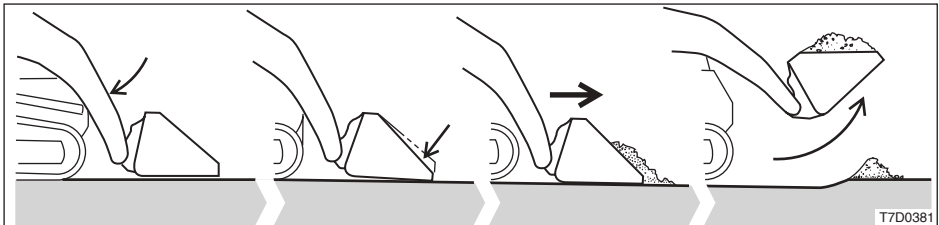

Tilt the front edge of the bucket down at an angle that is appropriate for the ground hardness, then drive the loader forward slowly, digging into the ground with the cutting edge of the bucket. When the bucket is full, tilt it rearward.

Leveling

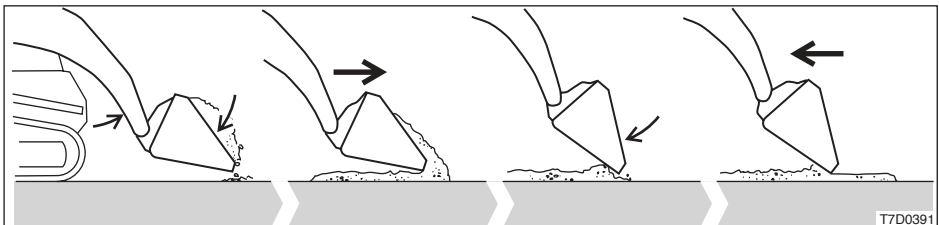

Raise the lift arms and tilt the bucket forward, then release it as the loader is driven forward. Next tilt the bucket forward and lower the front edge until it is slightly above the ground surface, then back the loader over the load that was just released.



Backfilling

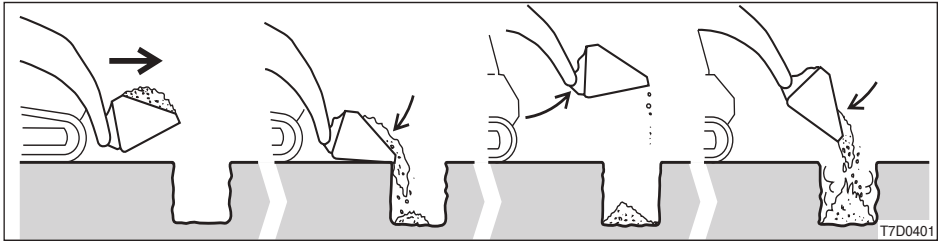

With the bucket lowered, drive near the hole and tilt the front edge of the bucket downward as soon as it passes over the near side of the hole. Raise the bucket and empty the load only when necessary.

Leveling Operation using the Float position

WARNING

- **Make sure the bucket is lowered to the ground before floating the lift arms. Floating the lift arms while they are raised will cause the bucket to fall rapidly and is dangerous.**
- **Do not drive the loader forward with the lift arms in Float position.**

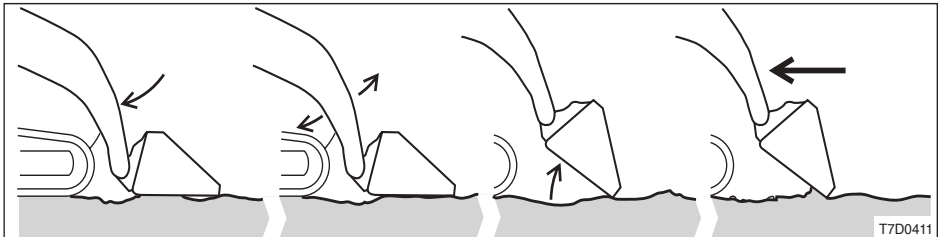

Lower the bucket onto the ground, then put the lift arms in Float position. Tilt the bucket forward to stand it on its cutting edge, then level the loose material while driving rearward.

Loading

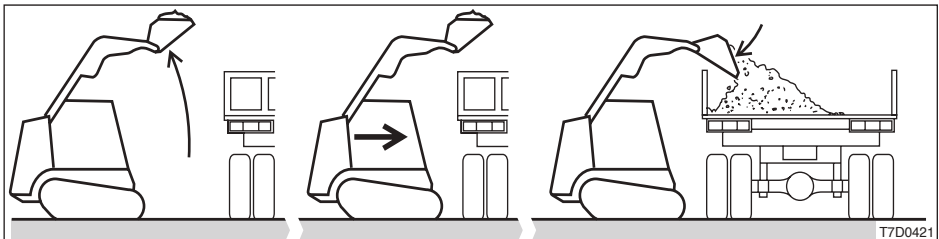

Approach the truck and stop, then raise the bucket until its lower edge clears the truck bed. Drive the loader slowly forward, stop at the position where the bucket is to be tilted forward, then tilt the bucket forward, releasing the material in the bucket into the truck bed. When the truck is half loaded, use the bucket to spread the load evenly.



Parking

! WARNING

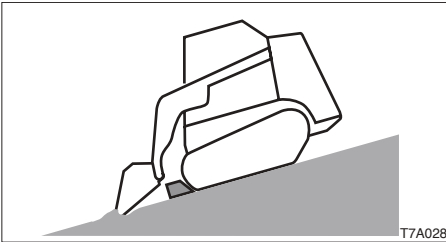
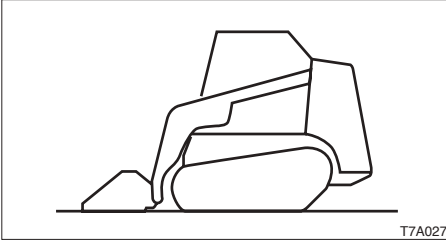

- Park the machine on firm, level ground and apply the parking brake. If you must park on a slope or incline, park across the slope and block the machine securely to prevent movement.
- When parking on streets, use barriers, caution signs, lights, etc., so that the machine can easily be seen even at night to avoid collision with other vehicles.
- Before leaving the operator's seat, set the safety bar to the lock position and stop the engine.
- Never leave the machine with the engine running or the lift arms raised, unattended. If arms are left in raised position, they **MUST** be restrained by the lift arm stop.

Before leaving the machine, do the following:

1. Set the control levers and pedal to the neutral position.
2. Return the throttle lever to idle position and idle the engine at low speed.
3. Lower the bucket to the ground.
4. Set the safety bar to the lock position.
5. Stop the engine and remove the key.
Refer to page 73, "Stopping the Engine."

Inspection and Checks After Stopping the Engine

1. Check for oil and water leakage and inspect the working equipment, covers and chassis. If any irregularities are found, repair.
2. Fill the fuel tank.
Refer to page 118, "Inspecting the Fuel Level."
3. Remove any debris and dirt from the engine compartment.
4. Remove any mud from the chassis.

Locking

Be sure to lock the following places:

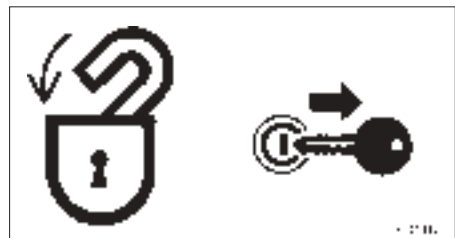

- Fuel filler cap
- Engine hood
- Manual storage
- Cab door



Preparing for Cold Weather

In cold weather, it may be difficult to start the engine and the coolant may freeze. Make the preparations described below.

Changing the Fuel and Lubricant

Change the fuel, hydraulic oil and engine oil to types suited for cold conditions.

Refer to page 104, "Lubricant and Fuel Chart."

Engine Coolant

WARNING

The coolant is combustible. Keep flames away.

Use long-life coolant (antifreeze) and tap water for the engine coolant.

Supplement: New machines are delivered with JIS Type 2 long-life coolant (antifreeze) at a concentration of 50%.

Refer to page 104, "Lubricant and Fuel Chart."

Battery

As the temperature drops, the battery performance decreases.

Inspect the battery. If the charge is low, contact a Gehl dealer to have the battery charged.

Refer to page 130, "Inspecting the Battery Fluid Level and Replenishing."

Cautions after Completing Operations

Heed the following to prevent dirt, water, or other objects being stuck on the machine as well as the lower chassis from freezing:

- Remove any dirt or water from the chassis.

In particular, water droplets on the hydraulic cylinder rod surfaces could freeze, and if dirt and ice enter into the seals, the seals could break.

- Park the machine on a dry, hard surface. If no appropriate place can be found, put boards down and park on the boards.
- Drain any water from the fuel tank to prevent freezing.

Refer to page 132, "Draining the Fuel Tank."

- To prevent decreased battery performance, place a cover over the battery or remove it from the machine and store it in a warm place.

Also add battery fluid before starting the next morning. If battery fluid is added after completing operations, the distilled water may not mix, resulting in freezing.

After Cold Weather is Over

Perform the following after cold weather is over:

- Change the fuel and the oils for those specified on the Fuel and Lubricant Chart.

Refer to page 104, "Lubricant and Fuel Chart."

- When using one-season type antifreeze coolant, completely drain the antifreeze coolant, carefully clean the inside of the coolant system, then add tap water. Refer to page 142, "Cleaning the Engine Cooling System."



Rubber tracks have an inherent weakness due to their use of rubber. Be sure to follow the prohibitions and cautions below to prevent damage to the tracks and track slippage.

Prohibited Actions

Do not travel or operate the machine in the following places:

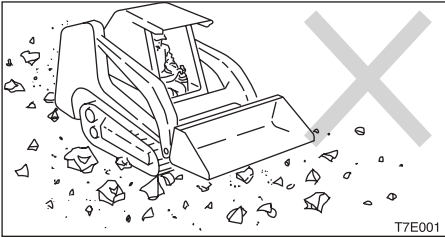

- Traveling or slewing on broken stone, jagged base rock, iron rods, iron scraps or the edges of iron sheets may damage or cut the tracks.

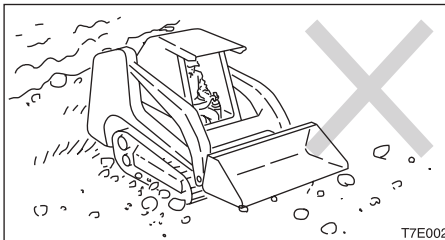

- Traveling on riverbeds or places with many soft rocks may cause the tracks to slip off or be damaged due to rocks getting stuck in them.
- Do not use on the seashore. The salt may corrode the metal cores of the tracks.

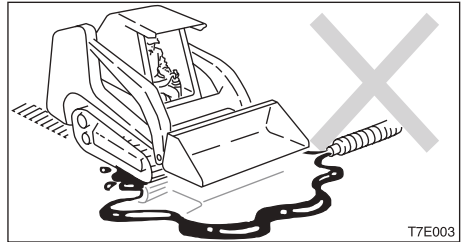

- Do not let fuel, oil, salt or chemical solvents get on the tracks. These substances may corrode the couplings of the tracks' metal cores, resulting in rust or peeling. If these substances get on the tracks, wipe them off immediately using water.

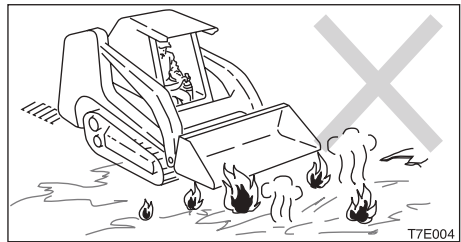

- Traveling on roads directly after asphaltting or on hot surfaces, such as over fires, or on iron sheets under strong sunlight may result in irregular wear or damage to the lugs.
- Do not move earth in places where the rubber tracks may slip. Doing so may increase lug wear.



Precautions

Follow the following precautions when operating the machine:

- Avoid changing course abruptly and spinning on concrete surfaces whenever possible.
Doing so may wear or damage the rubber tracks.
- Avoid drops that may expose the rubber tracks to strong shocks.
- Salt, potassium chloride, ammonium sulfate, potassium sulfate, and triple superphosphate of lime can damage the tracks. If any of these substances get on the tracks, wash them off thoroughly with water.
- Do not let the sides of the rubber tracks rub against concrete or walls.
- Be especially careful in the winter on snowy or frozen surfaces as the tracks tend to slip.
- Use rubber tracks only at temperatures between -25°C to $+55^{\circ}\text{C}$ (-14°F to 131°F).
- When storing the rubber tracks for long periods of time (3 months or more), do so indoors in a place not exposed to direct sunlight or rain.

Preventing the Rubber Tracks from Slipping Off

Heed the following to prevent the rubber tracks from slipping off:

- Always keep the tracks at the proper tension.

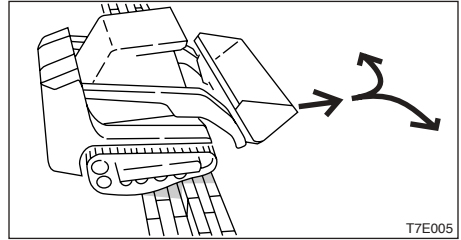

- When traveling up large cobblestone or rock steps [20 cm (8 in.) or greater], climb up the steps at a straight angle and do not change course on top of the step.

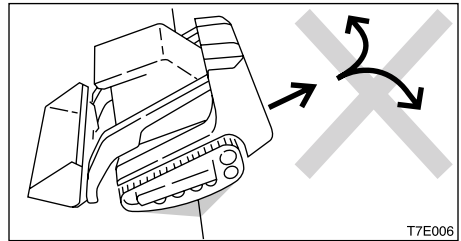

- When climbing in reverse, do not change course at the point where the slope starts.

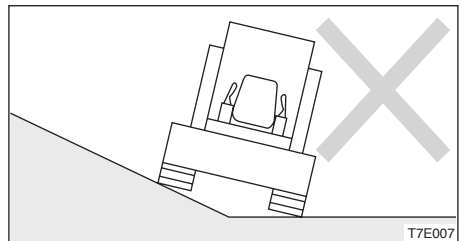

- Avoid traveling with one track on a slope or projecting object and the other track on a flat surface (with the machine at a tilt of 10° or greater). Travel with both tracks on flat surfaces.

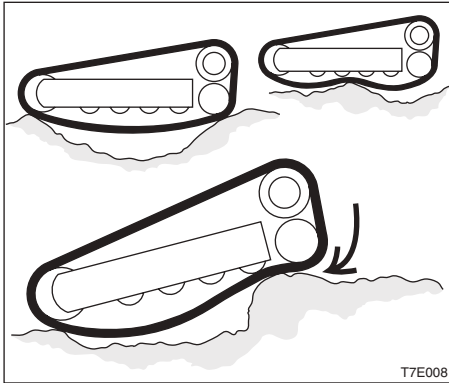

- Do not change directions when the tracks are slack, as shown in the diagram.



TRANSPORT

Hoisting the Machine	96
Loading and Unloading.....	98
Securing the Machine	99
Cautions on Transporting	100

**! WARNING**

- Know and use correct crane signals.
- Inspect the hoisting equipment daily for damaged or missing parts.
- When hoisting, use a wire rope with sufficient strength for the machine's weight.
- Do not hoist with the machine in a position other than the one described in the procedure below. Doing so is dangerous, because it may result in the machine losing its balance.
- Do not hoist the machine with an operator on it.
- When hoisting, hoist slowly so that the machine does not tip.
- Keep all other persons out of the area when hoisting. Do not move the machine over the heads of the persons.

IMPORTANT: This hoisting method applies to machines with standard specifications.

The center-of-gravity differs according to the attachments and options that are mounted.

Consult a Gehl dealer.

Hoisting

1. Lower the bucket to the ground.
2. Raise the safety bar to engage the lock.
3. Stop the engine and remove the starter key and get off the machine.
4. Install the sling as shown on the diagram. Suspend in such a way that the sling and lifting tool do not touch the chassis.
5. Hoist slowly until the machine just leaves the ground.
6. Stop hoisting until the machine is stable and hoist again slowly.

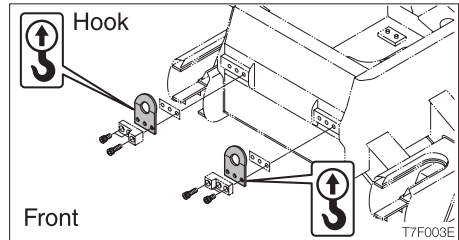
Hoisting position

< CTL55 / CTL65 >

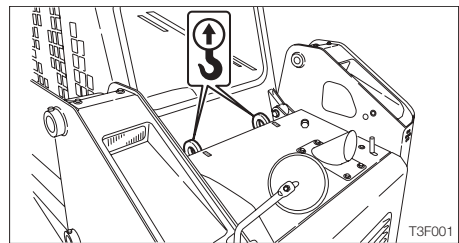

< CTL75 / CTL85 >

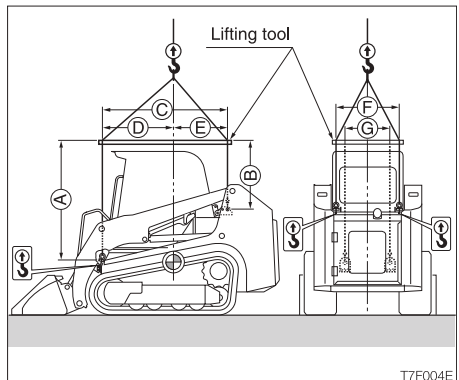
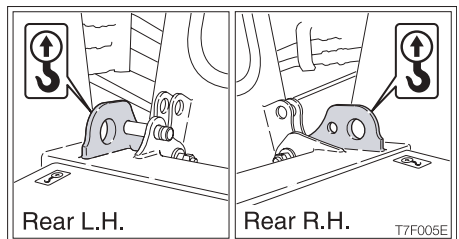



	CTL55	CTL65
A	1555 (61.3)	1675 (65.9)
B	930 (36.7)	1005 (39.6)
C	1525 (60)	1590 (62.6)
D	950 (37.4)	960 (37.8)
E	575 (22.6)	635 (25)
F	585 (23.1)	440 (17.3)
G	425 (16.7)	600 (23.6)

Units : mm (inches)

	CTL75	CTL85
A	1660 (65.3)	1705 (67.1)
B	940 (37.1)	950 (37.4)
C	1720 (67.7)	1895 (74.6)
D	985 (38.8)	1110 (43.7)
E	735 (28.9)	785 (30.9)
F	880 (34.7)	880 (34.6)
G	630 (24.7)	615 (24.2)

Units : mm (inches)

**! WARNING**

The machine may roll or tip over or fall while loading or unloading it. Take the following precautions:

- Select a firm, level surface and keep sufficient distance from road shoulders.
- Use loading ramps of adequate strength and size. Maintain the slope of loading ramps to 15 degrees or less.
- Keep the truck bed and loading ramps clean of oil, clay, ice, snow, and other materials that can become slippery. Clean the tracks.
- Never change course on the ramp.

When loading or unloading the machine, be sure to use ramps and follow the procedure below:

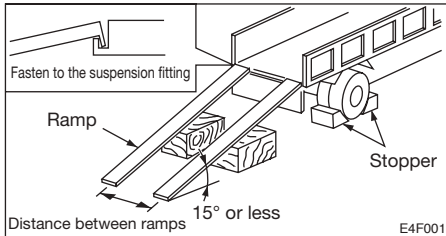

1. Apply the truck's parking brake and place chocks (stoppers) against its tires.
2. Fasten the ramps securely to the truck bed so that they will not come off. Set the ramps to an angle of 15° or less.
3. Move the machine up or down the ramps with the bucket end facing downward.
4. Line up the center of the truck bed with the center of the machine and the center of the ramps with the center of the crawlers.
5. Make sure the bucket does not hit the ramps.
6. Lower the engine speed.

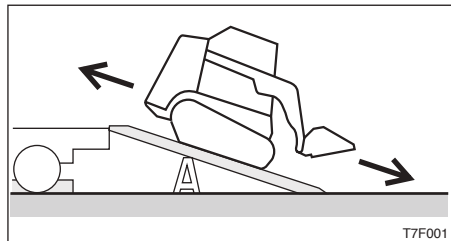

7. Determine the direction on the ramps, then slowly travel up or down the ramps in 1st speed (low speed), following the signals of a flagman.
8. Load the machine properly at the prescribed position on the bed. Refer to page 99, "Transporting Position."



After loading the machine in the designated position, secure it as described below.

Transporting Position

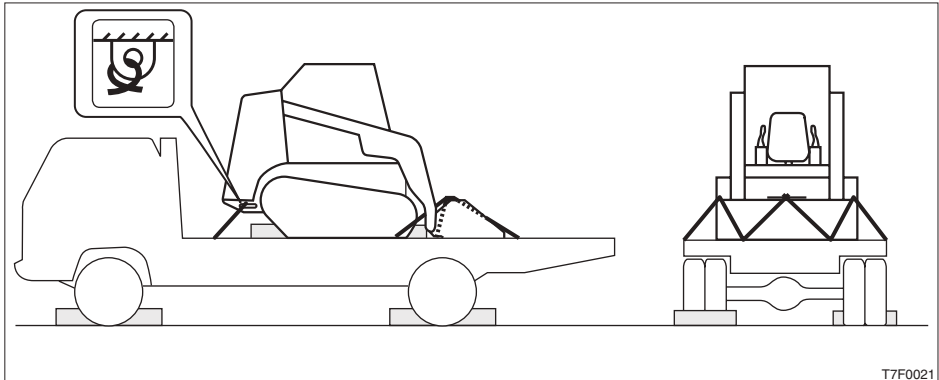

1. Lower the bucket.
2. Stop the engine and remove the ignition key.
3. Set the safety bar securely to the locked position.
4. Set stoppers in front and behind the tracks.
5. Put a chain or wire rope over the lower frame and fasten it securely to prevent sideways slippage.
6. Secure the bucket with a chain or wire rope.



Cautions on Transporting



WARNING

- Know and follow the safety rules, vehicle code and traffic laws when transporting the machine.
 - Consider the length, width, height and weight of the truck with the machine loaded on it when determining the best route.
-



MAINTENANCE

General	102
Service Data.....	104
Important Parts	109
Maintenance Chart	110
Maintenance Log	112
Walk-Around Inspection	114
Daily Inspection (Every 10 Hours).....	116
After First 50 Hours (New Machines Only).....	122
Every 50 Hours	128
Every 100 Hours	134
After First 250 Hours (New Machines Only).....	135
Every 250 Hours	136
Every 500 Hours	138
Every 1000 Hours	142
Every 1500 Hours	146
Every 2000 Hours	147
Every 3000 Hours	147
When Required.....	148
Long-term Storage	153



Maintenance Description

For long-term use of the machine under good conditions, perform the inspection and maintenance procedures properly and safely as recommended in this manual.

The inspection and maintenance items are divided according to the machine's total operating time (inspection and maintenance to be performed every 10 hours (walk-around and daily inspection), every 50 hours, every 250 hours, etc.). Refer to the hour meter to determine when it is time to perform inspection and maintenance. Items for which it is not possible to determine the inspection and maintenance interval are included under "When Required".

When operating the machine in extremely harsh environments (with high dust levels or high temperatures), inspection and maintenance should be performed earlier than the times indicated on the Maintenance Chart.

Cautions on Maintenance

Do not perform inspection and maintenance procedures not prescribed in this manual. Have inspection and maintenance procedures not prescribed in this manual performed by a Gehl dealer.

Always keep the machine clean.

- Always keep the machine clean, and wash it before performing inspection and maintenance.
- When washing the machine with water, stop the engine and cover the electrical system with plastic to protect it from water. Exposing the electrical system to water is dangerous and could result in short-circuits or malfunction. Do not wash the battery, sensors, electronic control components, connectors or the inside of the cab with water or steam.

Fuel, lubricant and grease

- For fuels, lubricant and grease, follow the instructions on the "Lubricant and Fuel Chart."
- Use pure fuels, lubricants and greases that do not contain water, and be careful to keep dirt out when changing or replenishing fuel, lubricant or grease.
- Store fuels, lubricants and greases in the prescribed places and in such a way that no water or dirt can get in them.

Cautions on fueling

- If the fill pipe includes a strainer, do not remove the strainer when fueling.
- After fueling, be sure to securely tighten the cap, etc.
- Do not add more than the prescribed amount of fuel.

**Do not clean parts with fuel.**

Do not use fuel to clean parts. Use a non-combustible cleaning agent.

Keep dirt out.

When mounting and removing parts, do so in a place where there is no dust, clean the working area and the part, and keep dirt out.

Clean mounting surfaces.

When mounting and removing parts, be sure that the surfaces of contact of the parts are clean. If the sealing grooves of the surface of contact are damaged, consult a Gehl dealer.

Seals and split pins

- Replace removed seals and split pins with new ones.
- When mounting, be careful not to damage or twist the seal.

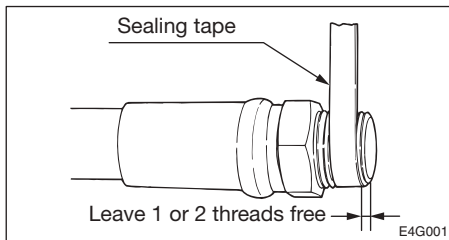
Sealing tape

- When wrapping sealing tape around plugs, etc., remove any old sealing tape from the threads and clean the threads.
- Wrap the sealing tape tight, leaving 1 or 2 threads at the tip free.

Disposing of wastes

- Collect waste fluids from the machine in containers. Disposing of wastes irresponsibly damages the environment.
- Dispose of oil, fuel, cooling water, coolant, filters, batteries and other harmful substances as prescribed by law.

Check after maintenance

- Gradually increase the engine speed from a low idle to maximum speed and check that there is no oil or water leaking from serviced parts.
- Operate all the control levers and check that the machine is operating properly.

Cautions on handling of battery cables

- Disconnect the battery cables (+,-) before working on the electrical system or doing any welding.
Remove the negative (-) battery cable first.
When reconnecting the battery, connect the negative (-) battery cable last.
- Do not disconnect the battery cables while the engine is running. Doing so could damage the electronic circuitry of the alternator and other parts.



Lubricant and Fuel Chart

Use different lubricants, greases and fuels according to the temperature, referring to the chart below.

- Change the lubricant earlier than as shown in the table if it is extremely dirty or its performance has deteriorated severely.
- Whenever possible, use the same brand of lubricant as before. If changing with a different brand, replace the entire quantity – do not mix different brands.

Lubricants and greases

Part	Type	Type by temperature								Replacement interval	Capacity Lit. (US. qt.)	
		-22 -30	-4 -20	14 -10	32 0	50 10	68 20	86 30	104°F 40°C			
Engine oil pan	Diesel engine oil API-CF or higher									SAE 10W-30 SAE 15W-40	After first 50 hrs. Every 250 hrs.	Upper limit CTL55:7.4(7.8) CTL65:10.2(10.8) CTL75:10.2(10.8) CTL85:13.2(13.9)
Hydraulic tank	Diesel engine oil API-CD, CE or CF									SAE 10W-30 SAE 10W-40	Every 1000 hrs.	System CTL55:45 (11.9 US.gal.) CTL65:58 (15.3 US.gal.) CTL75:75 (19.8 US.gal.) CTL85:95 (25.1 US.gal.) Tank CTL55:29 (7.7 US.gal.) CTL65:39 (10.2 US.gal.) CTL75:49 (12.8 US.gal.) CTL85:60 (15.9 US.gal.)
Engine cooling system	Cooling water (water + coolant)**									50% coolant mixture 30% coolant mixture	Every 1000 hrs.	CTL55:11 (11.6) CTL65:16.5 (17.4) CTL75:16.5 (17.4) CTL85:16.5 (17.4)
Travel reduction gear	Gear oil API-GL-4									SAE 90	After first 250 hrs.* Every 500 hrs.	CTL55:1.0 (1.06) CTL65:1.0 (1.06) CTL75:1.6 (1.69) CTL85:1.6 (1.69)
Working equipment	Lithium-based grease EP-2									—	Daily or every 10 hrs.	As required
Levers and Pedal	NLGI No.2									—	When required	



* : If the percentage of the traveling time within the total operating time is high, replace the gear oil earlier than the specified time.

** : For water, use tap water (soft). Do not use well or river water.

When the ambient temperature drops below 0°C, add coolant (antifreeze). Follow the coolant manufacturer's instructions to determine the mixture ratio.

Fuel

Diesel Fuel Specifications

Diesel fuel should comply with the following specifications. The table lists several worldwide specifications for diesel fuels.

Diesel Fuel Specification	Location	Diesel Fuel Specification	Location
ASTM D975 No.1D S15, S500 No.2D S15, S500	USA	ISO 8217 DMX	International
EN590:96	European Union	BS 2869-A1 or A2	United Kingdom

Part	Type	Capacity L (US gal.)
Fuel tank	Diesel fuel Use a clean, quality fuel for good performance and optimum engine life. <ul style="list-style-type: none"> ● To prevent fuel flow problems in cold weather, use diesel fuel with a pour point of at least – 12°C (10°F) below the lowest expected ambient temperature. ● Minimum cetane number is 45. Low temperature or high altitude operation may require the use of fuel with a higher cetane number. ● Use fuel with sulfur content of less than 0.05% by volume. A higher sulfur content fuel may cause sulfuric acid corrosion in the cylinders of the engines. ● NEVER mix kerosene, used engine oil, or residual fuels with the diesel fuel. ● Poor quality fuel can reduce engine performance and / or cause engine damage. ● Fuel additives are not recommended. Some fuel additives may cause poor engine performance. 	CTL55: 57 (15.1 US gal.) CTL65: 75 (19.8 US gal.) CTL75: 90 (23.8 US gal.) CTL85: 108 (28.5 US gal.)



Expendables

Replace wear-out items such as filters and elements periodically, referring to the table below.

Item	Part name	Part No.	Replacement interval
Hydraulic oil return filter	Element	195564	After first 50 hrs.
Pilot line filter	Element	180324	Every 500 hrs.
Fuel filter	Cartridge	CTL55: 195566 CTL65: 195566 CTL75: 195566 CTL85: 195567	Every 500 hrs.
Engine oil filter	Cartridge	CTL55: 195568 CTL65: 194315 CTL75: 194315 CTL85: 195569	After first 50 hrs. Every 250 hrs.
Air cleaner	Outer Element	CTL55: 195570 CTL65: 195570 CTL75: 195571 CTL85: 195571	Every 250 hrs. or when the air cleaner warning lamp lights (Do not clean)
	Inner Element	CTL55: 195573 CTL65: 195573 CTL75: 195574 CTL85: 195574	Every 250 hrs. or when the air cleaner warning lamp lights (Do not clean)



Tools

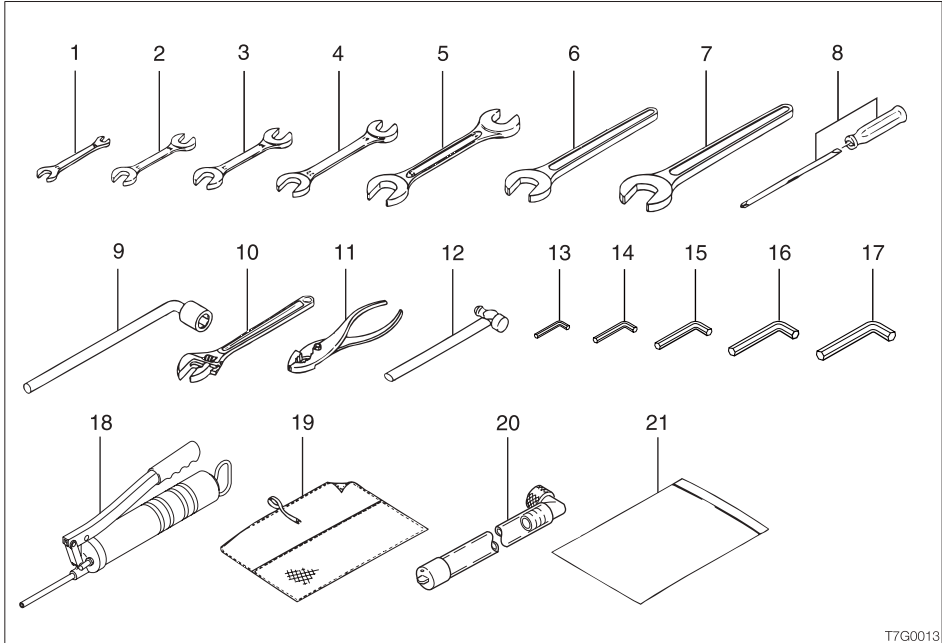

T7G0013

No.	Part name	Part No.	Remarks
1	Wrench		10-12
2	Wrench		11-13
3	Wrench		14-17
4	Wrench		19-22
5	Wrench		24-27
6	Wrench		30
7	Wrench		41
8	Screwdriver		(+) (-)
9	L-type wrench		19
10	Adjustable wrench		250 mm
11	Pliers		200 mm

No.	Part name	Part No.	Remarks
12	Hammer		3/4
13	Allen wrench		5 mm
14	Allen wrench		6 mm
15	Allen wrench		8 mm
16	Allen wrench		10 mm
17	Allen wrench		14 mm
18	Grease gun		600 cc
19	Tool case		
20	Drain connector		
21	Case		



Tightening Torques

Nuts and Bolts (for ISO strength category 10.9)

Tighten nuts and bolts at the torques shown on the table below, unless otherwise specified in the text.

- Tightening torques when mounting plastic covers differ from the values on the table below. Consult a Gehl dealer. Tightening too forcefully will break the cover.
- When replacing nuts and bolts, replace them with nuts and bolts of the same size and standards.
- Tighten nuts and bolts alternately (top, bottom, left then right) or in 2 or 3 times so that they are tightened uniformly.

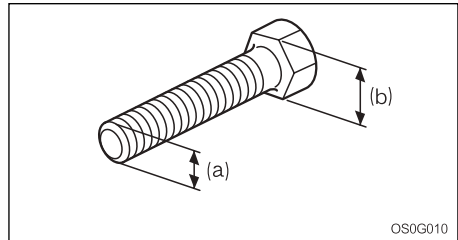
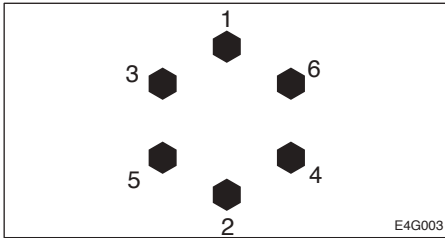

Thread	Head width (b)	Size (a) X Pitch	Torque	
			General Connection Points	
	mm	mm	N·m	ft·lb
Coarse	10	M6 X 1.0	9.8 ± 0.5	7.2 ± 0.4
	12, 13	M8 X 1.25	22.6 ± 1.1	16.6 ± 0.8
	14, 17	M10 X 1.5	47.1 ± 2.4	34.7 ± 1.7
	17, 19	M12 X 1.75	83.4 ± 4.1	61.5 ± 3.0
	19, 22	M14 X 2.0	134.4 ± 6.7	99.1 ± 4.9
	22, 24	M16 X 2.0	207.9 ± 10.4	153.3 ± 7.7
	27, 30	M20 X 2.5	410.9 ± 20.5	303.1 ± 15.1
Fine	12, 13	M8 X 1.0	24.5 ± 1.2	18.1 ± 0.9
	14, 17	M10 X 1.25	50 ± 2.5	36.9 ± 1.8
	17, 19	M12 X 1.5	87.3 ± 4.3	64.4 ± 3.2
	19, 22	M14 X 1.5	135.3 ± 6.8	99.8 ± 5.0
	22, 24	M16 X 1.5	220.6 ± 11	162.7 ± 8.1
	27, 30	M20 X 1.5	452.1 ± 22.6	333.4 ± 16.6



For safe use, the machine must be serviced periodically. To increase safety, periodically replace the parts listed in the following Table of Important Parts.

Serious injury or a fire could result if they deteriorate or are damaged.

Table of Important Parts

Unit		Important parts to be replaced periodically	Replacement Interval
Fuel system		Fuel hoses	Every 2 years
		Packing in fuel filler cap	
Engine connection		Engine oil filter hoses	
Heater & AC systems		Heater hoses	
		Air conditioner hoses	
Hydraulic system	Machine body	Hydraulic hoses (Pump - delivery)	
		Hydraulic hoses (Pump - suction)	
		Hydraulic hoses (Travel motor)	
	Working equipment	Hydraulic hoses (Lift arm cylinder lines)	
		Hydraulic hoses (Bucket cylinder lines)	
		Hydraulic hoses (Quick hitch cylinder lines)	
		Hydraulic hoses (Pilot valve)	
	Hydraulic hoses (Auxiliary lines)		
	Seat belt	Every 3 years	

Above important parts are vulnerable to aging and wear or deterioration and it is difficult to determine the degree to which they have deteriorated during periodic service. To maintain their proper function at all times, therefore, replace them with new ones after using them for a specific period of time, even if no abnormality is found with the parts. If you find abnormalities in these parts before their scheduled replacement time is reached, repair or replace them immediately. If a hose clamp is deformed or cracked, replace it immediately.

When replacing the important parts, please contact a Gehl dealer.

Also check the hydraulic hoses other than the above important parts. If any abnormality is found in them, retighten them or replace them immediately.

When replacing the hydraulic hoses, replace the O-rings and seals at the same time.

Check the fuel and hydraulic hoses according to the periodic schedule described below. Refer to "Maintenance."

Type of inspection	Inspection item
Daily inspection	Leakage from joints, hydraulic or fuel hoses.
Monthly inspection	Leakage from joints, hydraulic or fuel hoses.
	Damaged hydraulic or fuel hoses (cracks, wear and tear).
Annual inspection	Leakage from joints, hydraulic or fuel hoses.
	Deteriorated, twisted, damaged hydraulic or fuel hoses (cracks, wear and tear) or hoses in contact with other parts of the machine.



Maintenance Items	Page
Walk-Around Inspection	
Inspecting by opening the engine hood and rear door	114
Inspecting by walking around the machine	115
Inspecting while sitting in the operator's seat	115
Daily Inspection (Every 10 Hours)	
Inspecting and replenishing the coolant	116
Inspecting and replenishing the engine oil	117
Inspecting the water separator	117
Inspecting the fuel level	118
Inspecting the hydraulic oil level and replenishing	119
Lubricating the working equipment	120
After First 50 Hours (New Machines Only)	
Replacing the hydraulic oil return filter	122
Replacing the engine oil and oil filter	123
Inspecting and adjusting the fan belt	125
Replacing the pilot line filter	126
Every 50 Hours	
Inspecting and adjusting the track tension	128
Inspecting the battery fluid level and replenishing	130
Draining the fuel tank	132
Inspecting the bucket stoppers (bolts / nuts)	133
Every 100 Hours	
Cleaning the water separator	134
After First 250 Hours (New Machines Only)	
Replacing the travel motor gear oil*	135

- * If the percentage of the travel time within the total operating time is high, replace the gear oil earlier than the specified time.



Maintenance Items	Page
Every 250 Hours	
Replacing the air cleaner elements	136
Cleaning the radiator fins and oil cooler fins	137
Replacing the engine oil and oil filter	137
Inspecting and adjusting the fan belt	137
Cleaning the condenser < CTL55 Option >	137
Inspecting and adjusting the air conditioner belt < CTL55 Option >	137
Every 500 Hours	
Replacing the fuel filter	138
Replacing the hydraulic oil return filter	139
Replacing the pilot line filter	139
Replacing the travel motor gear oil*	139
Adjusting or replacing the bucket stoppers (bolts / nuts)	140
Every 1000 Hours	
Cleaning the engine cooling system	142
Replacing the hydraulic oil and cleaning the suction strainer	144
Inspecting and adjusting the engine valve clearance	146
Retightening the engine cylinder head bolts	146
Every 1500 Hours	
Inspecting and cleaning the engine fuel injectors	146
Inspecting the crankcase breather system	146
Every 2000 Hours	
Lapping the engine valve seats	147
Every 3000 Hours	
Inspecting the turbocharger (Blower wash as necessary) <CTL55/CTL75/CTL85>	147
Inspecting and cleaning the EGR valve, lead valve and cooler	147
When Required	
Replacing the bucket or attachment	148
Lubricating the levers	150
Inspecting and replenishing the windshield washer fluid	150
Tilting up the ROPS	151
Inspecting the rubber tracks	152



Perform the following inspections once every day before starting the engine the first time.

! WARNING

- **Before operating, perform the walk-around inspections and make repairs immediately if any irregularities are found.**
- **Be sure to secure the engine hood or rear door when opening it. Do not open the engine hood or rear door on slopes or in strong winds.**

Before starting the engine, look around the machine and lower chassis, clean any combustible materials off high temperature parts of the engine, and inspect for irregularities, such as oil leakage, water leakage and loose nuts and bolts.

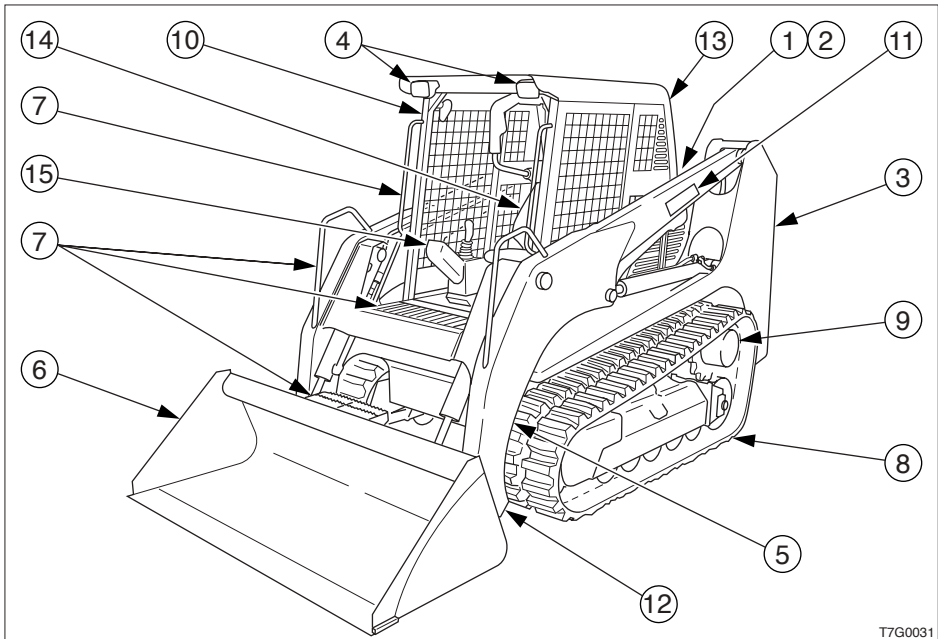

T7G0031

Inspecting by Opening the Engine Hood and Rear Door

1. Check for any twigs, leaves, oil or other combustible materials around the engine and battery.
2. Check for oil and engine coolant water leakage around the engine.
3. Check for oil leakage from the hydraulic tank, hydraulic devices, hoses and connections.

**Inspecting by Walking Around the Machine**

4. Check lights for dirt, damage and burned out bulbs.
5. Check attachments and hoses for damage.
6. Check the bucket for wear, damage and looseness.
7. Check the handrail and step for damage and loose bolts.
8. Check the tracks, track rollers, idlers and sprockets for damage, wear and loose bolts.
9. Check for oil leakage from the travel motor.
10. Check the ROPS / cab and guard for damage and loose nuts and bolts.
Check the rearview mirrors for dirt, damage, and angle adjustment.
11. Check the decals for dirt and damage.
12. Inspect the bucket stops for damage, or looseness

Inspecting While Sitting in the Operator's Seat

13. Check the windshield for dirt or damage (for machines with cab door).
14. Check the seat and seat belt for dirt and damage.
Check the operator's compartment for dirt, oil and other combustible materials.
15. Check the monitor, instruments and switches for dirt and damage.



Perform the following inspections once every day before starting the engine the first time.

! WARNING

- Before operating, perform the daily inspections and make repairs immediately if any irregularities are found.
- Be sure to secure the engine hood or rear door when opening it. Do not open the engine hood or rear door on slopes or in strong winds.

Inspecting and Replenishing the Coolant**! WARNING**

Do not remove the radiator cap or drain plugs when the coolant is hot. Stop the engine, let the engine and radiator cool, and loosen the radiator cap or drain plugs slowly.

Replenishing

1. Remove the reserve tank cap (2).
2. Add coolant up to the upper limit (H) of the reserve tank (1).

If the reserve tank is empty, inspect for fluid leakage, then inspect the radiator (3) coolant level. If it is low, add coolant to the radiator (3) first, then to the reserve tank.

3. Install the cap (2).

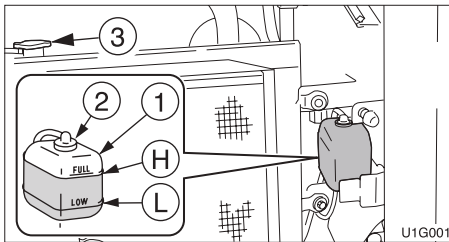
Inspection

1. Open the rear door.
2. Inspect the quantity of coolant in the reserve tank (1).
The level should be between the upper limit (H) and lower limit (L).
If it is below the lower limit (L), replenish.



Inspecting and Replenishing the Engine Oil

WARNING

Stop the engine and allow the machine to cool before performing inspection and maintenance.

Inspection

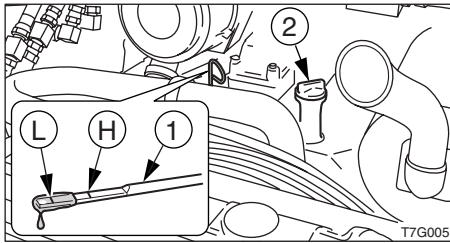

1. Open the engine hood.
2. Pull out the dipstick (1) and wipe off the oil with a rag.
3. Fully reinsert the dipstick (1), then pull it back out.
4. Check the oil on the dipstick (1).
The level should be between the upper limit (H) and lower limit (L).
If it is below the lower limit (L), replenish.

Replenishing

1. Remove the oil supply cap (2).
2. Add oil up to the upper limit (H) of the dipstick (1).
Problems could arise if the oil level is either too low or too high.
3. Tighten the oil supply cap (2).
4. Start the engine, run it at low idle for about 3 minutes, then stop it.
5. After about 10 minutes, inspect the oil level.

Inspecting the Water Separator

WARNING

Stop the engine and allow the machine to cool before performing inspection and maintenance.

< CTL55 / CTL65 / CTL75 >

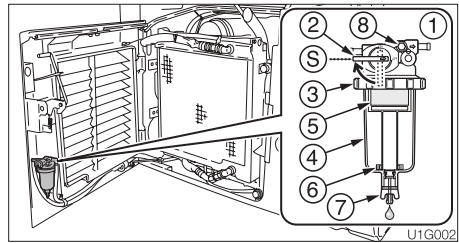

Ⓢ : Closed

1. Open the rear door.
2. Inspect the water separator (1).
If the red indicator ring (6) is sunk to the bottom of the case (4), no water is mixed in.
If the red indicator ring (6) is floating, there is water up to the bottom of the ring. Drain the water and clean.
3. Place a pan under the drain valve (7).
4. Open the drain valve (7) and drain the water.
If the water does not drain easily, loosen the vent plug (8).
5. Close the drain valve (7) and vent plug (8).
Refer to page 134, "Cleaning the Water Separator."



< CTL85 >

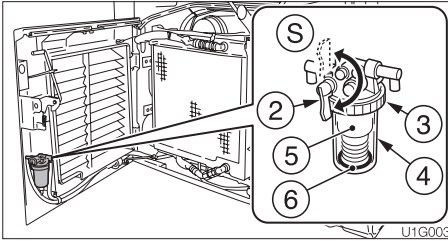

1. Open the rear door.
2. Inspect the water separator (1).
If the red indicator ring (6) is sunk to the bottom of the case (4), no water is mixed in.
If the red indicator ring (6) is floating, there is water up to the bottom of the ring. Drain the water and clean.
Refer to page 134, "Cleaning the Water Separator."

Inspecting the Fuel Level

! WARNING

- Do not smoke or permit open flames while fueling or near fueling operations.
- Stop the engine in a well-ventilated place when adding fuel.
- Clean up spilled fuel immediately.
- Do not fill the fuel tank to capacity. Allow room for expansion.
- Tighten the fuel filler cap securely.

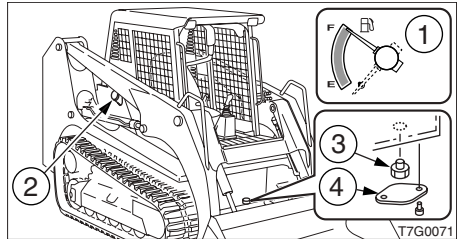

1. Check the fuel level using the fuel gauge (1).
F: full
E: empty
2. If the level is low, add fuel from the fuel port (2) while watching the fuel gauge (1).
Refer to page 47, "Fuel Filler Cap."



Inspecting the Hydraulic Oil Level and Replenishing

! WARNING

- Stop the engine and allow the machine to cool before performing maintenance.
- Oil may spray out if caps or filters are removed or pipes disconnected before releasing the pressure in the hydraulic system.
 - When removing plugs or screws or disconnecting hoses, stand to the side and loosen slowly, to gradually release the internal pressure before removing.

Inspection

The oil level changes according to the oil temperature. Inspect the oil level in the hydraulic oil level inspection position shown in the diagram.

- Hydraulic oil level inspection position

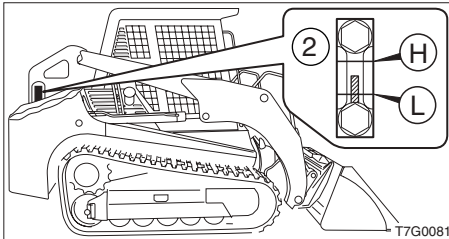

1. Start the engine and run it at low speed.
2. Fully retract the lift arms and bucket cylinders and ground the bucket.
3. Stop the engine.
4. Inspect the oil level using the sight gauge (2).
 - When the oil temperature is about 20°C (68°F):
The level should be halfway between the upper limit (H) and lower limit (L).
If it is below the lower limit (L), replenish.

- When the oil temperature is about 50 to 80°C (122 to 176°F):

The level should be near the upper limit (H).

Replenishing

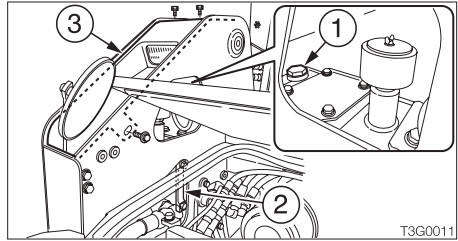

1. Loosen the bolts and remove the cover (3).
2. Remove the plug (1).
3. Add hydraulic oil up to the middle of the sight gauge (2).
4. Tighten the plug (1).
5. Install the cover (3).



Lubricating the Working Equipment

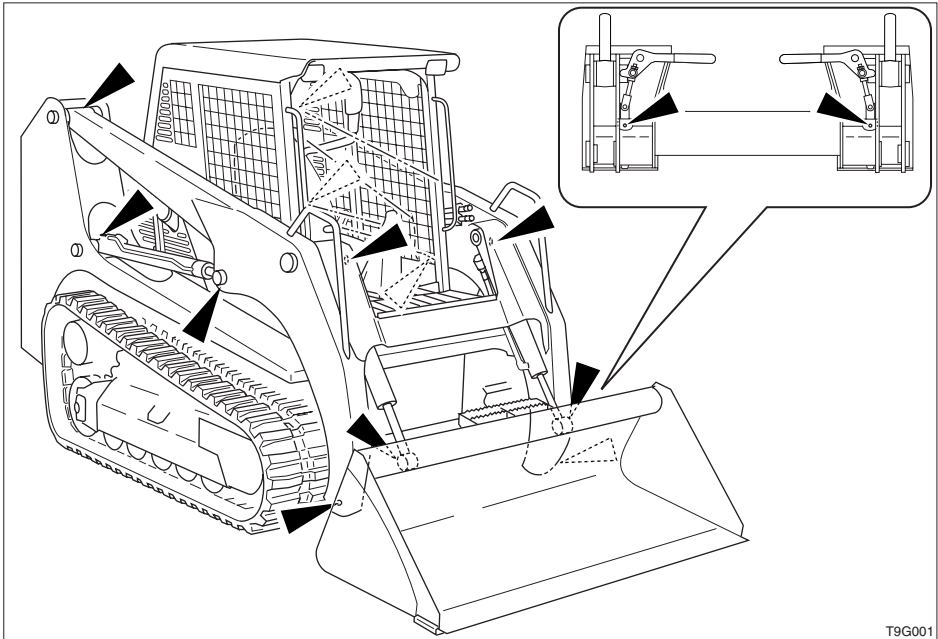

1. Set the machine to the lubrication position shown in the diagram above, ground the bucket, then stop the engine.
2. Use the grease gun to lubricate the grease fittings.
3. Wipe off the expelled grease.

MEMO



Replacing the Hydraulic Oil Return Filter

WARNING

- Stop the engine and allow the machine to cool before performing maintenance.
 - The engine, hydraulic lines and many other parts of the machine are hot directly after the engine is stopped. Touching these parts will cause burns.
 - The hydraulic fluid is also hot and under high pressure. Be careful when loosening caps and plugs. Working on the machine under these conditions could result in burns or injuries due to hot oil spraying out.
- Oil may spray out if caps or filters are removed or pipes disconnected before releasing the pressure in the hydraulic system.
 - When removing plugs or screws or disconnecting hoses, stand to the side and loosen slowly, to gradually release the internal pressure before removing.

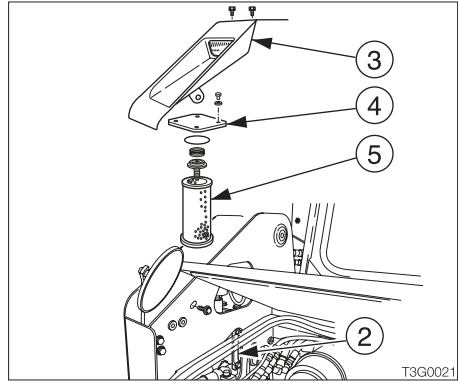

2. Loosen the bolts and remove the flange (4).
3. Remove the return filter (5).
4. Install the new return filter.
5. Install the flange (4).
6. Inspect the level with the sight gauge (2), and replenish if the level is low. Refer to page 119, "Inspecting the Hydraulic Oil Level and Replenishing."

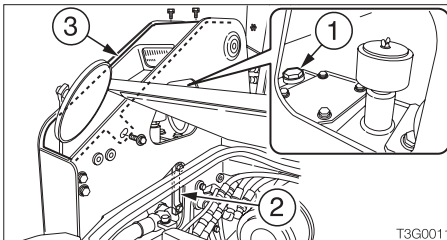

1. Loosen the bolts and remove the cover (3).



Replacing the Engine Oil and Oil Filter

WARNING

Stop the engine and allow the machine to cool before performing maintenance.

- The engine, muffler, radiator and many other parts of the machine are hot directly after the engine is stopped. Touching these parts will cause burns.
- The engine oil is also hot.

Be careful when loosening caps and plugs. Working on the machine under these conditions could result in burns.

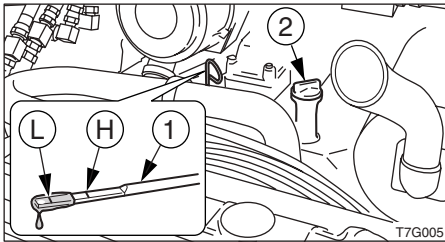

1. Open the engine hood.
2. Tilt up the ROPS.
Refer to page 151, "Tilting Up the ROPS."
3. Remove the oil supply cap (2).

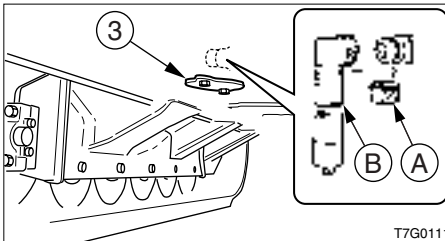

4. Place a pan under the under cover (3).
5. Loosen the bolts and remove the under cover (3).

6. Remove cap (A), install connector (B) and drain the oil. (The oil comes out when the screw is tightened.)
7. Remove connector (B) and install cap (A).

IMPORTANT: Check the waste oil. If it contains large amounts of metal powder, consult a Gehl dealer.

8. Install the under cover (3).

< CTL55 >

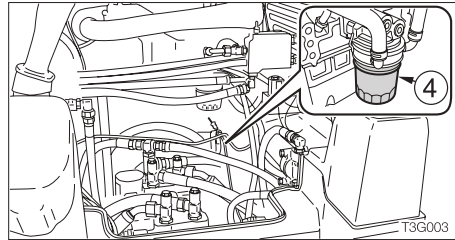

< CTL65 / CTL75 >

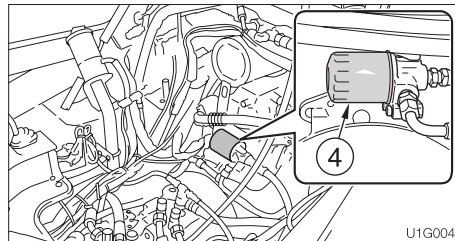

< CTL85 >

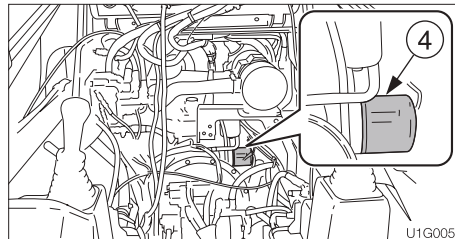

9. Using a filter wrench, turn the filter (4) counterclockwise and remove it.



10. Clean the filter installation surface on the filter stand.
11. Apply a thin layer of oil to the packing of the new filter.
12. Install the new filter by hand.
13. Tighten one more turn after the filter packing comes in contact with the surface.
14. Supply oil up to the upper limit (H) of the dipstick (1). Problems could arise if the oil level is either too low or too high.
15. Tighten the oil supply cap (2).
16. Lower the ROPS.
17. Start the engine, run it at low idle for about 3 minutes, then stop it.
18. After about 10 minutes, inspect the oil level.



Inspecting and Adjusting the Fan Belt

WARNING

Stop the engine and allow the machine to cool before performing inspection and maintenance.

- The engine, muffler, radiator, hydraulic lines, sliding parts and many other parts of the machine are hot directly after the engine is stopped. Touching these parts will cause burns.

Inspection

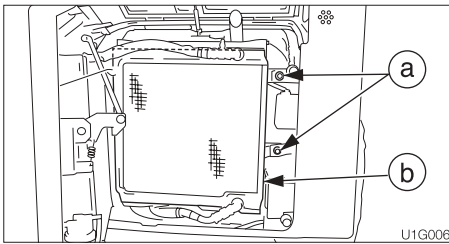

1. Open the rear door.
2. Remove the bolts (a) and open the radiator (b).

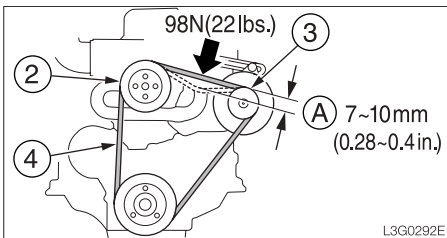

3. Press the fan belt midway between the fan pulley (2) and alternator pulley (3) and check the tension (about 98N or 22 lbs.). The slack (A) should be about 7 to 10 mm (0.28 to 0.4 in.).
4. Inspect the fan belt (4) and replace it if:
 - there are cuts or cracks.

- the belt is worn and touches the bottom of the V groove in the pulley.
- the belt stretches and cannot be adjusted.

Adjustment

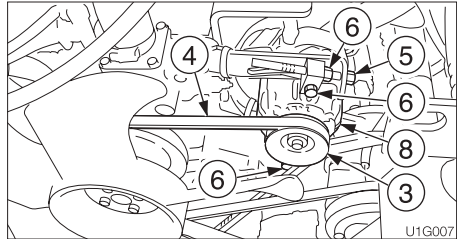

1. Loosen the locking nuts (6).
2. Turn the adjusting bolt (5) and adjust the fan belt (4).
 - Tighten: Clockwise
 - Loosen: Counterclockwise
3. Tighten the locking nuts (6).

Note: When replacing with a new belt (new belt slack: 5 to 8 mm), run the engine at low idle speed for about three to five minutes to break in the new belt, before adjusting the tension.



Replacing the Pilot Line Filter

WARNING

- Stop the engine and allow the machine to cool before performing maintenance.
- Oil may spray out if caps or filters are removed or pipes disconnected before releasing the pressure in the hydraulic system.
 - When removing plugs or screws or disconnecting hoses, stand to the side and loosen slowly, to gradually release the internal pressure before removing.

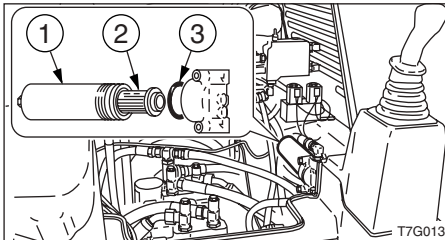

1. Tilt up the ROPS.
Refer to page 151, "Tilting Up the ROPS."
2. Turn the case (1) counterclockwise and remove it.
3. Remove the element (2) and O-ring (3).
4. Clean the inside of the case (1).
5. Install the new element in the case (1).
6. Install the new O-ring, then tighten the case (1).

MEMO



Inspecting and Adjusting the Track Tension

⚠ WARNING

- If you must work beneath the raised machine or equipment, always use wood blocks, jack-stands or other rigid and stable supports. Never get under the machine or working equipment if they are not sufficiently supported. This procedure is especially important when working on hydraulic cylinders.
- The track adjuster contains highly pressurized grease. If the tension is adjusted without following the prescribed procedure, the grease discharge valve may fly off, resulting in injury.
 - Loosen the grease discharge valve slowly.
 - Do not put your face, arms, legs or body in front of the grease discharge valve.
 - If no grease is expelled when the grease discharge valve is loosened, there is a problem. Contact your Gehl dealer for repairs. **DO NOT** disassemble, because this is very dangerous.

Inspection

< CTL55 >

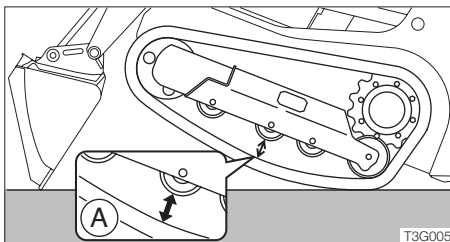

< CTL65 / CTL75 >

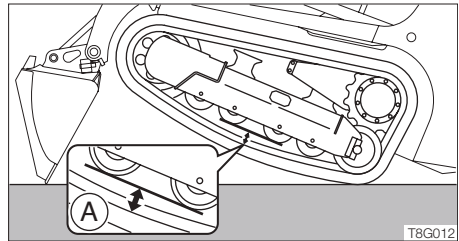

< CTL85 >

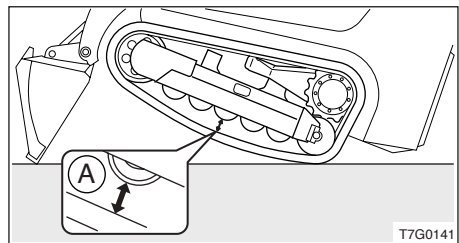

1. Lower the lift arm and tilt the bucket forward to raise the front of the loader off the ground as far as it will go.
2. Measure the clearance between the center track roller and the surface of the track where it makes contact with the roller.

The gap (A) should be within the following range:
25 to 50 mm (1 to 2 in.)

Adjustment

Increasing the tension

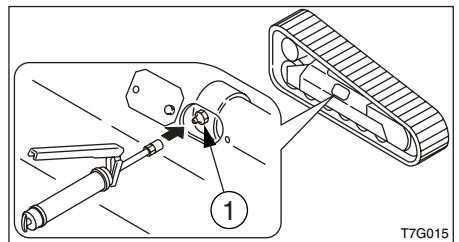

1. Remove the cover.



2. Use the grease gun to insert grease through the grease nipple in the grease discharge valve (1).
3. Check the track tension.

Decreasing the tension

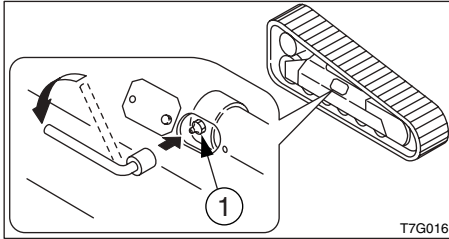

1. Remove the cover.
2. Use the wrench to slowly loosen the grease discharge valve (1) and drain the grease.
If the grease does not drain easily, move the machine forward or rearward.
3. Tighten the grease discharge valve (1).
 - Tightening torque: 59 N·m (43.4 ft·lb.)



Inspecting the Battery Fluid Level and Replenishing

⚠ DANGER

- Do not use the battery when the fluid level is below the lower level. Doing so will hasten the deterioration of the internal portions of the battery and shorten the battery life, and can also cause rupturing (or an explosion).
- Batteries generate flammable and explosive gases. Keep arcs, sparks, flames and lighted tobacco away.
- Use a dampened cloth to clean the area of the fluid level lines and check the fluid level. Note that if this area is cleaned with a dry cloth, static electricity could cause ignition or explosion.

⚠ WARNING

- Do not fill the battery above the upper level. Doing so could cause the fluid to leak, contact and damage the skin, or cause parts to corrode.
- Batteries contain sulfuric acid which will damage eyes or skin on contact.
 - If acid contacts eyes, flush immediately with clean water and get prompt medical attention.
 - If acid is accidentally swallowed, drink large quantities of water or milk and call a physician immediately.
 - If acid contacts skin or clothing, wash off immediately with clean water.

Inspection

IMPORTANT: Check the fluid level of all cells, even when the fluid level can be checked by indicator.

Note: Under normal operating conditions, the maintenance-free battery does not require addition of water because of the special plate designed to minimize fluid loss. However, for those machines that are heavily used or operated under severe conditions (for example, in high ambient temperature), the fluid level often becomes low. If that is the case, check the fluid level of the maintenance-free battery and add water as needed.

< CTL55 >

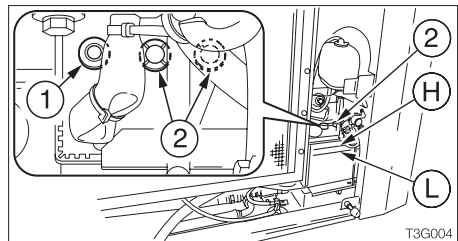

< CTL65 / CTL75 / CTL85 >

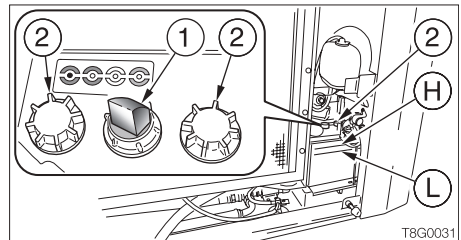

1. Open the rear door.
2. Inspect the indicator (1).
 - Blue: Charging complete
 - White: OK
 - Red / center White: Insufficient battery fluid
 - Red / center Red: Charging needed
3. Inspect the fluid level.

The fluid level should be between the lines indicating the upper level (H) and lower level (L). If not, add distilled water up to line (H).



- If the fluid level can not be checked by fluid level lines.

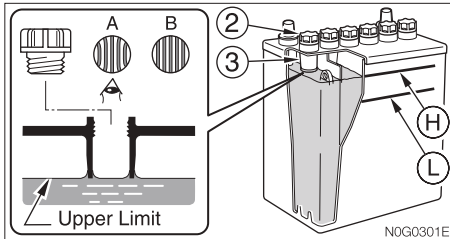

Remove the caps (2) and look into the fluid supply holes to check the fluid level. If the fluid is below the sleeve (3), be sure to add distilled water up to the bottom edge of the sleeve (3).

Proper amount (A)

The fluid reaches up to the bottom edge of the sleeve (3), so the surface tension causes the fluid to swell and the plate appears distorted.

Level too low (B)

The fluid does not reach up to the bottom edge of the sleeve (3), so the plate appears laminar, not distorted.

4. Also check the terminals for looseness and dirt.

Replenishing

When adding distilled water, do so before starting operations in order to prevent freezing.

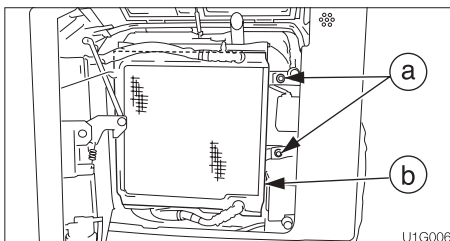

1. Remove the bolts (a) and open the radiator (b).

2. Remove the indicator (1) and caps (2), and add distilled water up to the upper level.
3. Tighten the indicator (1), which then turns blue.
4. Clean the cap's exhaust hole, then tighten the caps (2) securely.



Draining the Fuel Tank

WARNING

- Do not smoke or permit open flames while handling fuel or working on the fuel system.
- Stop the engine in a well-ventilated place and allow it to cool before performing maintenance.
- Clean up spilled fuel immediately.

Do this before operating the machine.

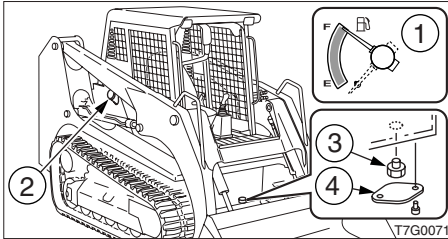

1. Remove the fuel filler cap (2).
2. Place a pan under the drain plug (3).
3. Remove the cover (4).
4. Remove the drain plug (3) and drain the water and sediment from the bottom of the tank.
5. Tighten the drain plug (3).
6. While watching the fuel gauge (1), add fuel.
7. Tighten the fuel filler cap (2) and lock it with the key.

Bleeding the air from the fuel system

Refer to page 159, “Bleeding the Air from the Fuel System.”

Note: Air in the fuel system can make it difficult to start the engine and cause engine problems. Also bleed the air when the fuel tank is emptied.



Inspecting the Bucket Stoppers (bolts / nuts)

WARNING

Before performing maintenance or repairs under the machine, set all working equipment against the ground or in the lowermost position.

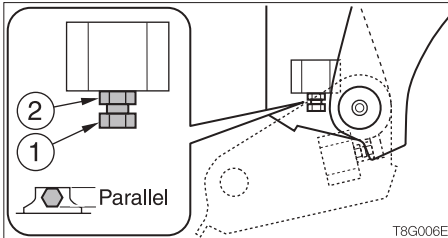
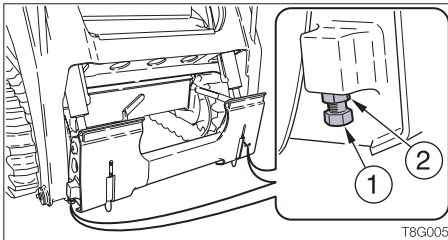

1. Park the machine on firm, level ground and remove the bucket.
2. Retract the bucket cylinders and lift arm cylinders to the minimum length.
3. Inspect the adjusting bolts (1) and lock nuts (2) for bending, denting, deformation and looseness.
4. If there are any irregularities with the adjusting bolts (1) and lock nuts (2). Refer to page 140, "Adjusting or Replacing the Bucket Stoppers (bolts/nuts)".



Cleaning the Water Separator

! WARNING

- Do not smoke or permit open flames while handling fuel or working on the fuel system.
- Stop the engine in a well-ventilated place and allow it to cool before performing maintenance.
- Clean up spilled fuel immediately.

< CTL55 / CTL65 / CTL75 >

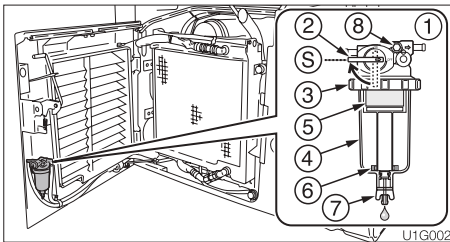

Ⓢ : Closed

1. Open the rear door.
2. Close the valve (2).
3. Loosen the ring (3), then remove the case (4), element (5) and indicator ring (6) and clean them.
4. Inspect the O-ring, and if there are any scratches or other irregularities, replace it.
5. Assemble the indicator ring (6), case (4) and element (5) and tighten the ring (3).
6. Open the valve (2).
7. Loosen the vent plug (8) and bleed the air.
8. Tighten the vent plug (8).

Refer to page 159, "Bleeding the Air from the Fuel System."

< CTL85 >

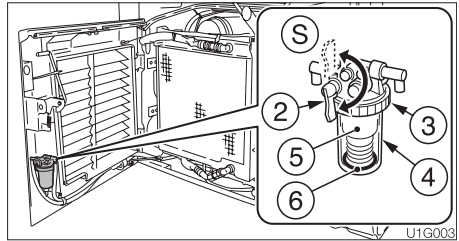

1. Open the rear door.
2. Close the valve (2).
3. Loosen the ring (3), then remove the case (4), element (5) and indicator ring (6) and clean them.
4. Inspect the O-ring, and if there are any scratches or other irregularities, replace it.
5. Assemble the indicator ring (6), case (4) and element (5) and tighten the ring (3).
6. Open the valve (2) and bleed the air.
Refer to page 159, "Bleeding the air from the fuel system."



Replacing the Travel Motor Gear Oil

WARNING

- Stop the engine and allow the machine to cool before performing maintenance.
 - The travel motors are hot directly after the engine is stopped. Touching them will cause burns.
 - The gear oil is also hot and under high pressure.
Be careful when loosening plugs. Working on the machine under these conditions could result in burns or injuries.
- The pressure in the travel motor reduction gears case may cause oil or the plug to fly out. Loosen the plug slowly to release the pressure.

IMPORTANT: If the percentage of the travel time within the total operating time is high, replace the gear oil earlier than the specified time.

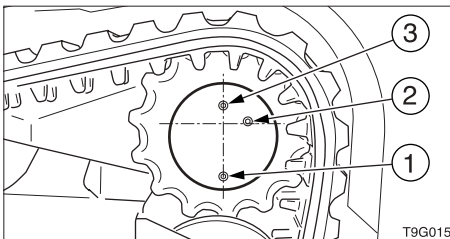

1. Set the travel motor so that plug (1) is at the very bottom.
2. Place a pan for catching the waste oil under plug (1).
3. Remove plugs (1), (2) and (3) and drain the oil.
4. Wrap new sealing tape around the plugs.

5. Tighten plug (1).
 - Tightening torque: 22 N·m (15.9 ft·lb.)
6. Supply oil through the hole for plug (3) until oil flows out of the hole of plug (2).
7. Tighten plugs (2) and (3).
 - Tightening torque: 22 N·m (15.9 ft·lb.)



Replacing the Air Cleaner Elements

⚠ WARNING

Stop the engine and allow the machine to cool before performing maintenance.

- The engine, muffler, radiator and many other parts of the machine are hot directly after the engine is stopped. Touching these parts will cause burns.

IMPORTANT: Do not use an element if its flutes, gaskets or seals are damaged.

IMPORTANT: Be sure to install the element and dust cap securely. If not, dust could be drawn into the cylinder, damaging the engine.

IMPORTANT: Be sure to lock the air cleaner after completing the maintenance.

1. Open the engine hood.

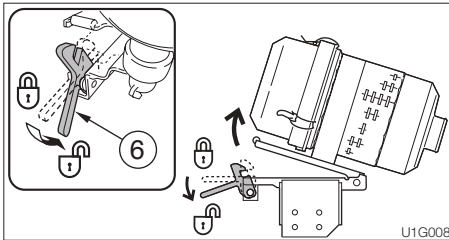

2. Push down the lever (6) to tilt up the air cleaner.

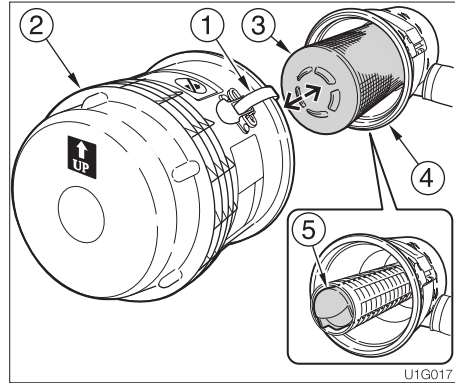

3. Loosen the clamps (1) and remove the dust cup (2).
4. Clean the inside of the dust cup (2).
5. Remove the outer element (3). Do not yet remove inner element (5).
6. Clean the inside of the body (4).
7. Remove the inner element (5).
8. Install the new elements. Press the elements firmly into the body (4).
9. Install the dust cup (2) with the "UP" mark at the top, then fasten it with the clamps (1).

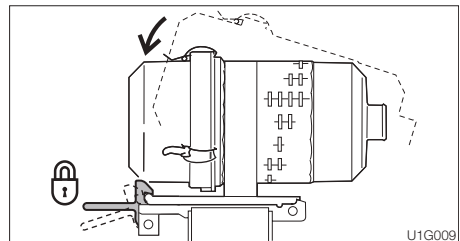

10. Push down the air cleaner and securely lock it.



Cleaning the Radiator Fins and Oil Cooler Fins

WARNING

Wear required appropriate equipment such as safety glasses and filter mask when using compressed air, because metal fragments or other objects can fly and cause serious personal injury.

IMPORTANT: Be careful not to damage the radiator fins and oil cooler fins when cleaning them.

- When using compressed air or pressurized water, make sure the pressure is no higher than 200 kPa (28 psi) and hold the nozzle sufficiently away from the fins.

IMPORTANT: When using water, cover the electrical system to prevent water from getting in.

IMPORTANT: When operating the machine in very dusty places, inspection and maintenance should be performed every day.

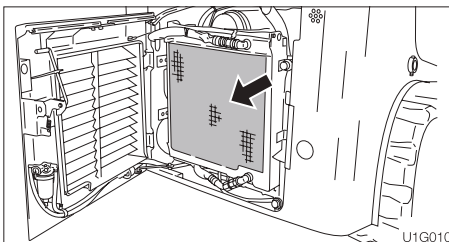

1. Open the rear door.
2. Blow compressed air on the radiator fins and oil cooler fins to remove mud and dirt stuck on them.

Replacing the Engine Oil and Oil Filter

Refer to page 123, “Replacing the Engine Oil and Oil Filter.”

Inspecting and Adjusting the Fan Belt

Refer to page 125, “Inspecting and Adjusting the Fan Belt.”

Cleaning the Condenser < CTL55 Option >

Refer to page 187, “Cleaning the Condenser.”

Inspecting and Adjusting the Air Conditioner Belt < CTL55 Option >

Refer to page 187, “Inspecting and Adjusting the Air Conditioner Belt.”



Replacing the Fuel Filter

WARNING

- Do not smoke or permit open flames while handling fuel or working on the fuel system.
- Stop the engine in a well-ventilated place and allow it to cool before performing maintenance.
- Clean up spilled fuel immediately.

< CTL55/CTL65/CTL/75 >

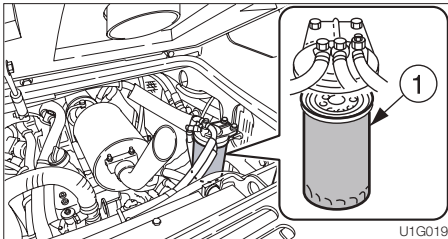

1. Open the engine hood.

< CTL85 >

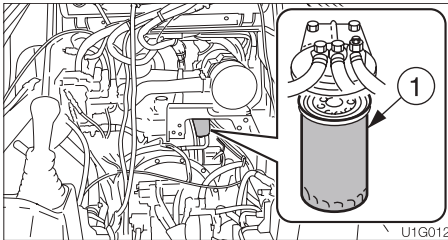

1. Tilt up the ROPS.

2. Place a pan under the filter (1).
3. Using a filter wrench, turn the filter (1) counterclockwise and remove it.
4. Clean the surface of installation of the filter stand.
5. Apply a thin layer of oil to the packing of the new filter.
6. Install the new filter by hand.
7. Tighten one more turn after the filter packing comes in contact with the surface of installation.
8. Bleed the air.

Refer to page 159, "Bleeding the Air from the Fuel System."



Replacing the Hydraulic Oil Return Filter

Refer to page 122, “Replacing the Hydraulic Oil Return Filter.”

Replacing the Pilot Line Filter

Refer to page 126, “Replacing the Pilot Line Filter.”

Replacing the Travel Motor Gear Oil

Refer to page 135, “Replacing the Travel Motor Gear Oil.”



Adjusting or Replacing the Bucket Stoppers (bolts / nuts)

DANGER

- If you must work beneath the raised lift arms, securely engage the lift arm stop. **Never get under the lift arms and bucket if they are not sufficiently supported.**
- Service the lift arm stop if damaged or if parts are missing. **Using a damaged lift arm stop or with missing parts can cause the lift arms to drop, causing injury or death.**

WARNING

- Park the machine on solid flat ground for work.
- Work as a 2-person team, and stay in communication with each other. **One person must sit at the operator's seat and stop the engine whenever necessary, and must take care not to touch the lever or pedal unless necessary. Set the engine speed to low when operating the control lever.** **The one who performs maintenance must make sure to keep their body or clothing away from the moving parts of the machine.**

For the adjustment of the bucket stopper, install the lift arm stop (2) used for the lift arm adjustment on the lift arm cylinder while the pin hole (1) of the lift arm should be positioned at the height of approximately 1500 mm (59.1 in) or 1600 mm (63 in) above the ground, as shown in the figure on the right. Adjustment work should be done while maintaining the machine at this attitude. To perform the inspection safely, obtain the lift arm stop (2) and the locking pin (3) in advance. The work should be done by two people. One of them must sit at the operator's seat and stop the

engine whenever necessary, while the other person installs/removes the lift arm stop (2) and adjusts the bucket stopper.

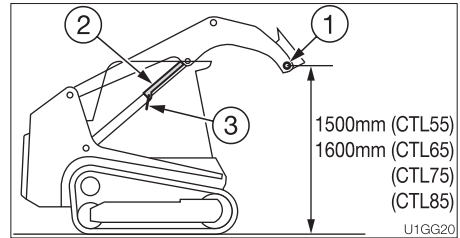

1. Park the machine on solid flat ground, and remove the bucket.
2. Lower the lift arm to its lowest position, and stop the engine.

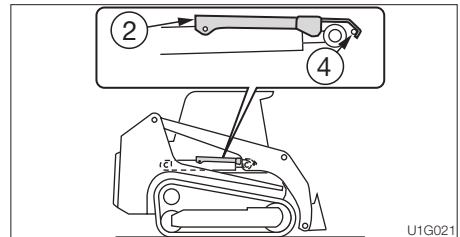

3. Hook the lift arm stop (2) on the steel bar (4) of the lift arm, and place it on the cylinder.

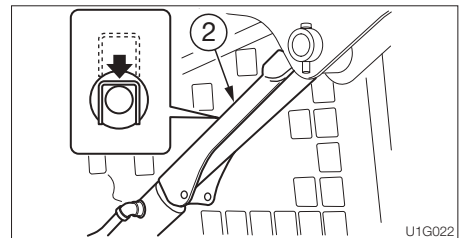



4. Start the engine, and raise the lift arm until the lift arm stop (2) falls on the cylinder rod.
5. Slowly lower the lift arm until the lift arm stop (2) hits against the edge of the cylinder tube and becomes fixed, and then stop the engine.

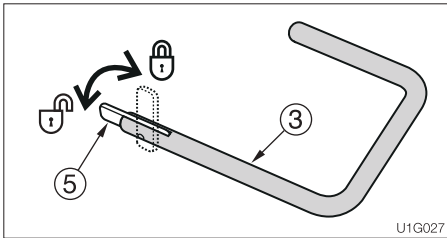
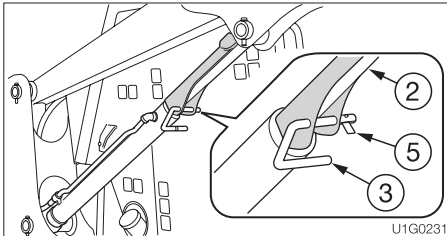

6. Insert the locking pin (3) in the front hole of the lift arm stop (2) and pass it through under the cylinder rod to the back hole.
7. To prevent the locking pin (3) from falling off, set the hook (5) at a right angle to the locking pin.

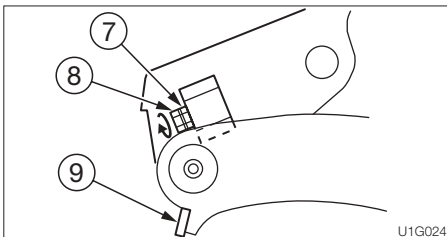

8. Loosen the lock nuts (7) and fully screw in the stopper bolts (8).

9. Start the engine, extend the bucket cylinders to the maximum length, and then stop the engine.
10. Adjust each plate (9) (right, left) and the stopper bolt (8) so that they evenly contact each other.
11. Start the engine, retract the bucket cylinders to the minimum length, and then stop the engine.

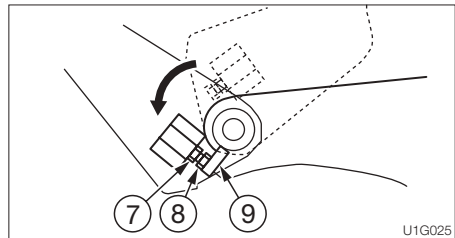

12. Adjust the height of the stopper bolts (8) so that they protrude 1 mm (2/3 turn), and tighten them with the lock nuts (7).
Stopper bolt, lock nut: ThreeBond #1324
Tightening torque:
Lock nut 416 N·m (306.7 ft·lb)

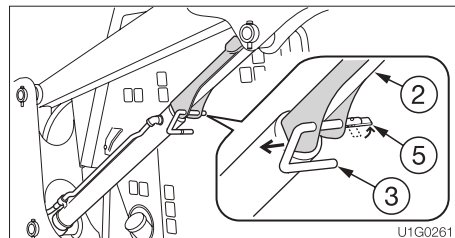

13. Start the engine, lift the lift arm until the lift arm stop (2) is disconnected, and then stop the engine.
14. Disengage the locking pin (3), and then remove the lift arm stop (2).
15. Start the engine, lower the lift arm to its lowest position, and then stop the engine.



Cleaning the Engine Cooling System

! WARNING

- Stop the engine and allow the machine to cool before performing maintenance.
 - The engine, muffler, radiator and many other parts of the machine are hot directly after the engine is stopped. Touching these parts will cause burns.
 - The engine coolant is also hot and under high pressure. Be careful when loosening caps and plugs. Working on the machine under these conditions could result in burns or injuries due to the hot coolant spurting out.
- If maintenance must be performed with the engine running, always work as a two-person team, with one person sitting in the operator's seat while the other works on the machine.
 - When performing maintenance, be sure to keep your body and clothing away from moving parts.
- Standing at the back of the machine while the engine is running is extremely dangerous, because the machine could move suddenly. Never stand at the back of the machine while the engine is running.
- Do not remove the radiator cap or drain plugs when the coolant is hot. Stop the engine, let the engine and radiator cool, and loosen the radiator cap or drain plugs slowly.

When cleaning, if the temperature of the coolant is low, the thermostat will be closed and the coolant will not circulate in the radiator. Heat the coolant to at least 90°C (195°F) before cleaning.

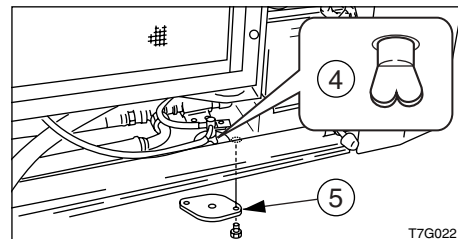
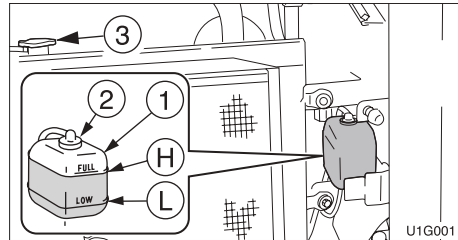

1. Open the rear door and remove the under cover (5).
2. Gradually loosen the radiator cap (3) to release the internal pressure, then remove the cap.
3. Place a pan to catch the waste coolant under the drain plug (4), then loosen the drain plug (4) and drain the coolant.
4. Tighten the drain plug (4).
5. Add tap water through the radiator's coolant supply port up to the top of the port. Take your time doing this, adding the water slowly to avoid any air entering the radiator.
6. Close the radiator cap (3).
7. Start the engine and run it at a speed slightly above low idling. Raise the coolant temperature to at least 90°C (195°F), then run the engine for about 10 minutes with the thermostat open.



8. Stop the engine, let the coolant temperature lower, then loosen the drain plug (4) and drain the coolant.
9. After draining the coolant, clean using cleaning agent. Follow the instructions included with the cleaning agent you are using.
10. Repeat steps 4 to 8 to flush the cooling system.
11. Tighten the drain plug (4), then install the under cover (5).
12. Slowly add the new coolant (mixture of antifreeze and tap water) through the radiator's filler neck up to the top of the filler neck. Take your time doing this.
13. Close the radiator cap (3).
14. Warm up the engine. Use the instruments to check that there are no irregularities in the cooling system at this time.
15. Raise the coolant temperature to at least 90°C (195°F), then run the engine for about 10 minutes.
16. Stop the engine, let the coolant temperature lower, then check the level of coolant in the radiator, and replenish it up to the top of the filler neck.
17. Close the radiator cap (3).
18. Clean the interior of the reserve tank (1), then add coolant to the upper limit (H).
19. After replacing the coolant, inspect the coolant level once again after operating the machine.

The coolant permeates the entire system during operation, so the level decreases. Replenish by the amount the level has decreased.



Replacing the Hydraulic Oil and Cleaning the Suction Strainer

WARNING

- Stop the engine and allow the machine to cool before performing maintenance.
- The engine, hydraulic lines and many other parts of the machine are hot directly after the engine is stopped. Touching these parts will cause burns.
- The hydraulic fluid is also hot and under high pressure.
Be careful when loosening caps and plugs. Working on the machine under these conditions could result in burns or injuries due to hot oil spraying out.
- Oil may spray out if caps or filters are removed or pipes disconnected before releasing the pressure in the hydraulic system.
 - When removing plugs or screws or disconnecting hoses, stand to the side and loosen slowly, to gradually release the internal pressure before removing.

1. Open the rear door.
2. Drain the coolant.
Refer to page 142, "Cleaning the Engine Cooling System."

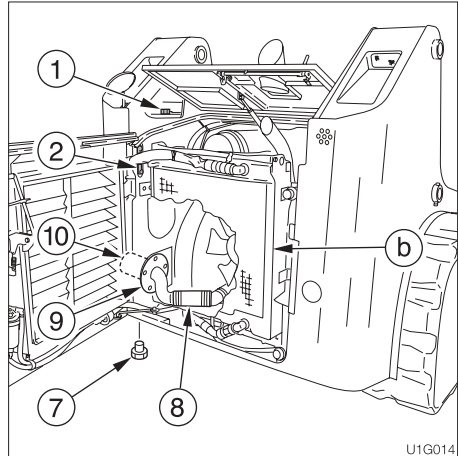

U1G014

3. Place a pan for catching the waste oil under the drain plug (7).
4. Loosen the drain plug (7) and drain the hydraulic oil.

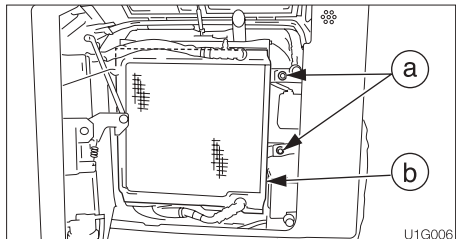

U1G006

5. Remove the bolts (a) and open the radiator / oil cooler (b).

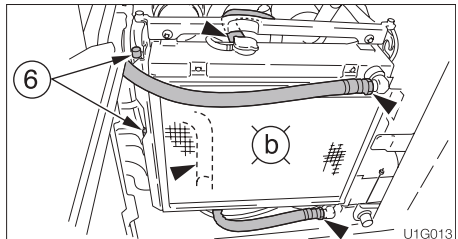

U1G013

6. Disconnect the hoses that are connected to the radiator / oil cooler (b).
7. Temporarily suspend the radiator / oil cooler (b).



8. Remove the split pin and pull out pins (6).
9. Lift out the radiator / oil cooler (b) and remove it.

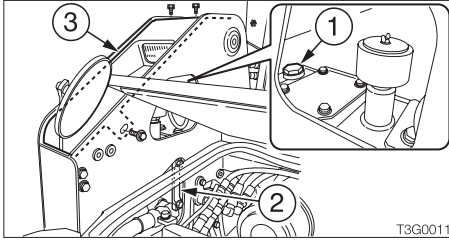

10. Remove the plug (1).

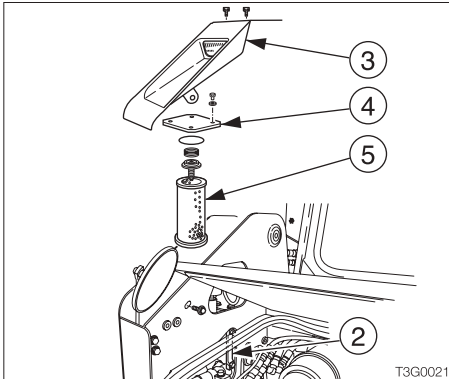

11. Remove the return filter (5).
Refer to page 122, "Replacing the Hydraulic Oil Return Filter."
12. Loosen the hose clip and remove the hose (8).
13. Loosen the bolts, and remove the flange (9).
14. Remove the suction strainer (10) and clean it.
15. Clean the inside of the hydraulic tank.
16. Install the new return filter.
Refer to page 122, "Replacing the Hydraulic Oil Return Filter."
17. Install the suction strainer (10) to the flange (9).
18. Install the flange (9).
19. Install the hose (8) to the flange (9).
20. Tighten the drain plug (7).

21. Replenish hydraulic oil up to the middle of the sight gauge (2) through the port for plug (1).
22. Tighten the plug (1).
23. Follow the procedure "Bleeding the air" below to bleed the air from the hydraulic oil circuit.
24. Set the machine to the hydraulic oil level inspection position and inspect the level after the temperature of the oil has dropped.
Refer to page 119, "Inspecting the Hydraulic Oil Level and Replenishing."

Bleeding the air

IMPORTANT: After replacing the hydraulic oil, bleed the air from the hydraulic circuit and hydraulic devices. Failure to do so may damage the hydraulic devices.

- Hydraulic pump
< CTL55 / CTL65 >

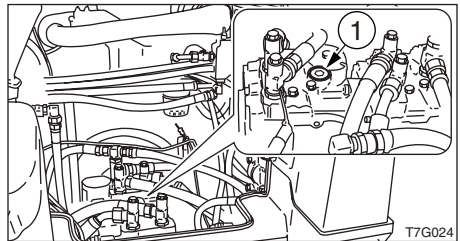

- < CTL75 / CTL85 >

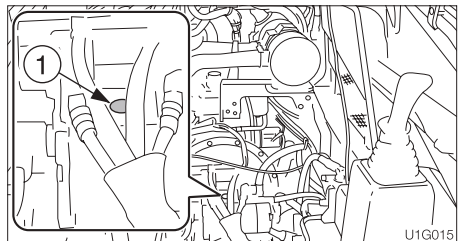

1. Tilt up the ROPS.
2. Remove the plug (1) from the hydraulic pump.
3. After hydraulic oil overflows from the plug hole, re-install the plug (1).



MAINTENANCE

Every 1000 Hours

● **Cylinders**

1. Start the engine and run it at low idle for 10 minutes.
2. Set the engine to a low idle, then extend and retract all the cylinders 4 or 5 times, without going to the stroke ends.
3. Run the engine at high speed, then extend and retract all the cylinders 4 or 5 times, without going to the stroke ends.
4. Set the engine back to a low idle, then extend and retract all the cylinders 4 or 5 times to the stroke ends.

Inspecting and Adjusting the Engine Valve Clearance

This operation requires experience. Have it performed by a Gehl dealer.

Retightening the Engine Cylinder Head Bolts

This operation requires experience. Have it performed by a Gehl dealer.



MAINTENANCE

Every 1500 Hours

Inspecting and Cleaning the Engine Fuel Injectors

This operation requires experience. Have it performed by a Gehl dealer.

Inspecting the Crankcase Breather System

This operation requires experience. Have it performed by a Gehl dealer.



MAINTENANCE

Every 2000 Hours



MAINTENANCE

Every 3000 Hours

Lapping the Engine Valve Seats

This operation requires experience. Have it performed by a Gehl dealer.

Inspecting the Turbocharger (Blower wash as necessary) <CTL55 / CTL75 / CTL85>

This operation requires experience. Have it performed by a Gehl dealer.

Inspecting and Cleaning the EGR Valve, Lead Valve and Cooler

This operation requires experience. Have it performed by a Gehl dealer.



Replacing the Bucket or Attachment

WARNING

- Read the manufacturer's instructions manual for attachments not included in this manual. **DO NOT** use attachments that are not approved by Gehl.
- Before performing maintenance or repairs under the machine, set all working equipment against the ground or in the lowermost position.

Installation

IMPORTANT: Before installing a bucket or attachment, make sure the mounting area of the bucket (1) and the quick-hitch (3) are clean.

1. Make sure the quick-hitch (3) lock levers (2) are in the unlocked position.

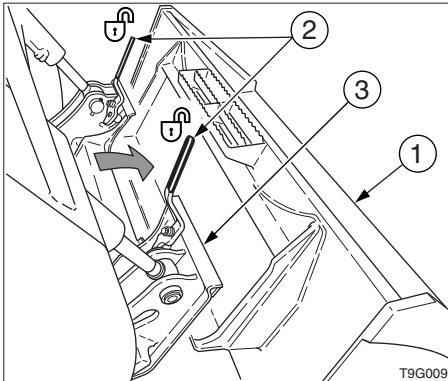

2. While sitting in the operator's seat with the safety bar down, start the engine and tilt the quick-hitch (3) forward.

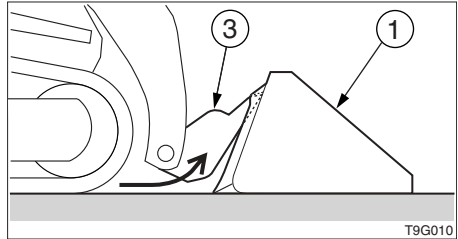

3. Move the machine slowly forward and raise the loader lift arms. The wedge-shaped top edge of the quick-hitch (3) must engage in the upper mounts of the bucket or attachment.

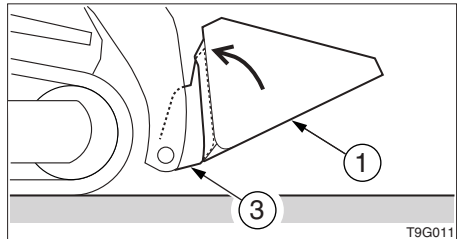

4. Roll the quick-hitch (3) back while lifting the bucket or attachment off the ground. The quick-hitch (3) will slide into position.
5. Lower the bucket or attachment until it is 25 to 50 mm (1 to 2 in.) off the ground.
6. Stop the engine and raise the safety bar.

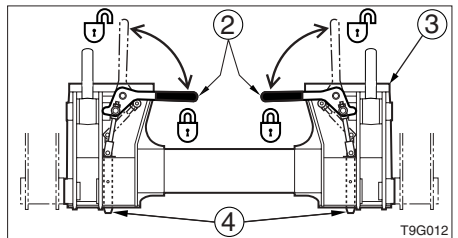

7. Push both quick-hitch (3) lock levers (2) down, securing the bucket or attachment in position.

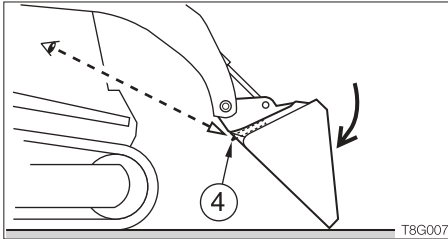

IMPORTANT: Before operating the machine, always inspect the quick-hitch latch pins (4) engagement by raising the loader arms high enough to view the latch pins (4) engagement from the operator's seat.

Note: If the quick-hitch (3) latch pins (4) do not lower into the LOCKED position, remove the attachment and investigate the cause.

Removal

1. Raise the bucket (1) or attachment 25 to 50 mm (1 to 2 in.) off the ground.
2. Stop the engine, raise the safety bar and release the seat belt.

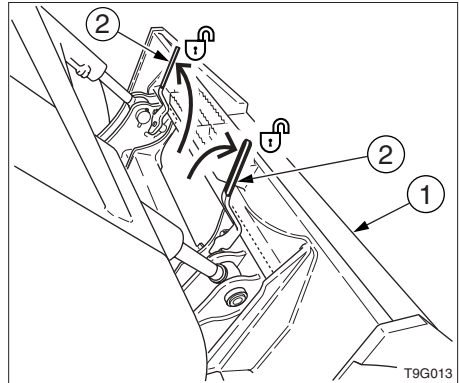

3. Pull both attachment lock levers (2) upward to disengage the bucket (1) or attachment.
4. Return to the operator's seat, lower the safety bar, fasten the seat belt and start the engine.

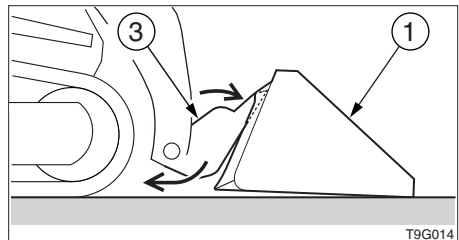

5. Rotate the quick-hitch (3) out (bucket dump function), allowing the bucket or attachment to slide off the top edge of the quick-hitch (3).



Lubricating the Levers

WARNING

Set the machine in the parking position, stop the engine, remove the ignition key and store it. Failure to do so may result in the machine moving abruptly, leading to serious injury or death.

If the levers or pedal no longer move smoothly, apply grease.

Control levers

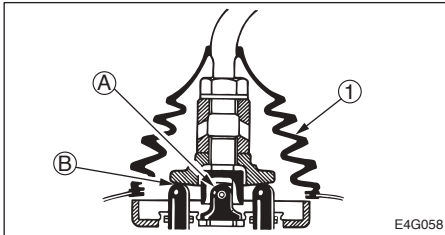

1. Remove the lower mount section of the boot (1) and turn it upwards.
2. Wipe off the old grease.
3. Apply grease to points (A) and (B).
4. Re-install the boot (1).

Inspecting and Replenishing the Windshield Washer Fluid

Use a windshield washer fluid intended specifically for motor vehicles. Follow the instructions included with the washer fluid.

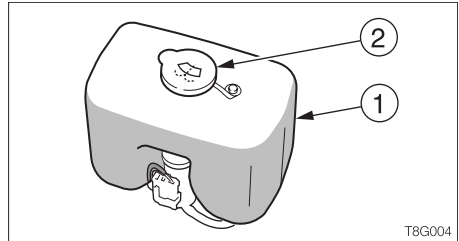

Inspection

1. Open the cab door.
2. Inspect the washer tank (1) and add washer fluid if the level is low.

Replenishing

1. Mix the washer fluid to the prescribed concentration.
2. Remove the cap (2) and add washer fluid.
3. Reinstall the cap (2).



Tilting Up the ROPS

For inspection and maintenance, the ROPS is designed so that it can be tilted up.

! WARNING

- Raising or lowering the ROPS while the engine is running may cause the machine to move, and cause serious injury or death. Lower the working equipment to the ground and stop the engine before raising or lowering the ROPS.
- When the ROPS is tilted up, support it firmly with the stopper to prevent it from falling.

Raising (Tilt up)

1. Select a firm, level surface, lower the working equipment to the ground, and stop the engine.
2. Set the safety bar to the lock position.

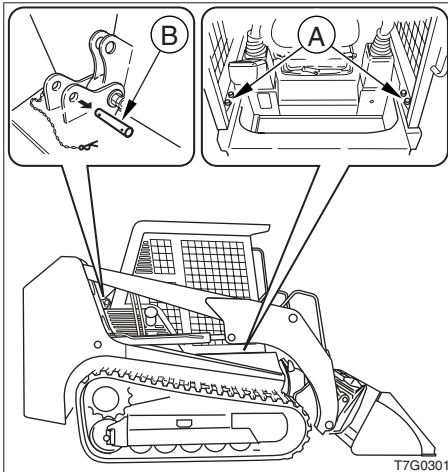

3. Remove a R-pin and remove the stopper pin (B).
4. Remove the lock bolts (A).

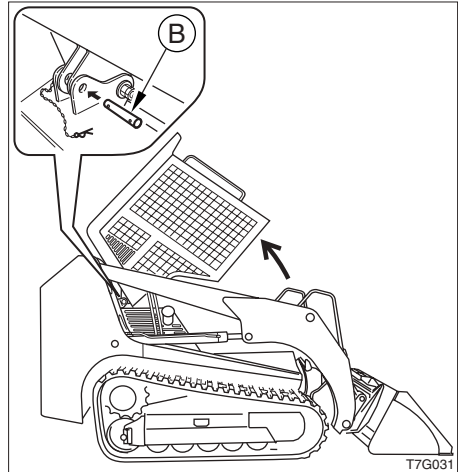

5. Slowly raise the ROPS.
 6. Insert the stopper pin (B) into the body's holder and insert an R-pin into the stopper pin's hole to fasten it in place.
- If you need to run the engine while the ROPS is raised, follow these steps.
7. Make sure that all levers and pedal are in neutral positions.
 8. Push the throttle lever to the low idle position.
 9. Start the engine.
 10. Be sure to stop the engine after inspection and maintenance.

Lowering

1. Remove the stopper pin (B).
2. Lower the ROPS.
3. Tighten the lock bolts (A).
4. Reinsert the stopper pin (B) into the body's holder.



Inspecting the Rubber Tracks

Repair or replace the rubber tracks if their conditions are as described below. Consult a Gehl dealer about repairs or replacement.

Rubber track

Replace the track if the entire track is stretched and cannot be adjusted.

(1) Lug

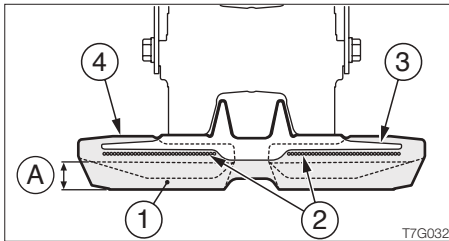

Replace if the height of the lugs (A) is 5 mm (0.2 in.) or less.

(2) Steel cord

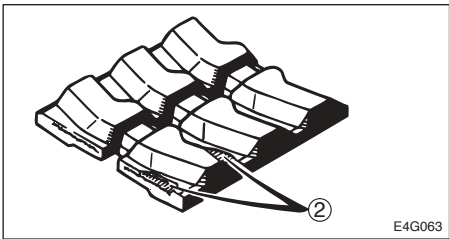

Replace if the steel cord is exposed over 2 or more links.

Replace if half or more of the steel cords on one side are cut.

(3) Metal core

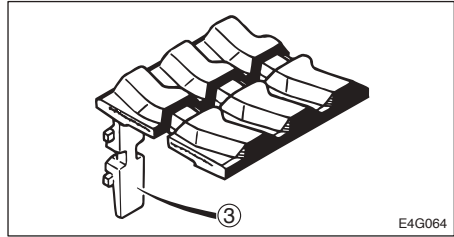

Replace if even one metal core is missing.

(4) Rubber

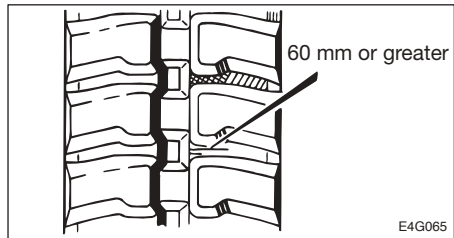

Replace if there are cracks of 60 mm (2.4 in.) or greater in length.

If the steel cord is visible, replace as soon as possible, regardless of the length of the crack.



Procedures for storage

If the machine is to be stored for 30 days or more, store it indoors. If it must be stored outdoors, park it on wood laid out on a flat surface and place a waterproof cover over it so that it stays dry.

1. Clean the machine.
2. Inspect for oil leakage, water leakage and loose nuts and bolts.
3. Add fuel and replace the hydraulic oil and oil.
4. To prevent rusting and freezing, replace the engine coolant with long-life coolant (LLC).
Refer to page 142, "Cleaning the Engine Cooling System."
5. Use the grease gun to apply grease to the grease fittings.
6. Fully retract the bucket cylinders and ground the bucket.
7. Apply rust-prevention oil to the hydraulic cylinder rods.
8. Disconnect the cable from the battery's "negative (-)" terminal and cover the battery to prevent freezing.

During storage

WARNING

- **Do not operate the engine in an enclosed area without adequate ventilation.**
- **If natural ventilation is poor, install ventilators, fans, exhaust extension pipes or other artificial venting devices.**

1. To prevent rusting, operate the machine once a month so that the oil is fully circulated.
2. Inspect the battery and recharge it if necessary.

Starting the machine after storage

IMPORTANT: If the "Procedures for storage" have not been performed and the machine has been stored for a long period of time, consult a Gehl dealer before reusing the machine.

1. Wipe off the rust-prevention oil that was applied to the hydraulic oil cylinder piston rods.
2. Add fuel, oil and grease to all parts.



TROUBLESHOOTING

Symptoms that Are Not Malfunctions	156
If the Engine Overheats.....	157
If the Battery Goes Dead	158
After the Fuel Runs Out.....	159
If a Fuse Blows	160
If a Warning Lamp Flashes	162
Other Symptoms	164
To Lower the Lift Arms	166
Towing.....	167



The following symptoms are not malfunctions:

- The travel motor produces noise when stopped suddenly during high-speed travel.
- The control valve produces noise if excessive force is applied to the working equipment and when the stroke end is reached.
- At times of combined operation of bucket and lift arm lowering, continuation of the combined operation after the bucket has reached the stroke end will result in the lift arm rising or stopping without going lower.
- Performance decreases when an attachment weighing more than a standard bucket is mounted.

**! WARNING**

- **Do not open the engine hood when there is steam coming from the engine compartment. The steam or hot water may spray out, resulting in burns.**
- **Do not remove the radiator cap or drain plugs when the coolant is hot. Stop the engine, let the engine and radiator cool and loosen the radiator cap or drain plugs slowly.**
- **Stop the engine and allow the machine to cool before performing inspection and maintenance.**

The following symptoms indicate overheating:

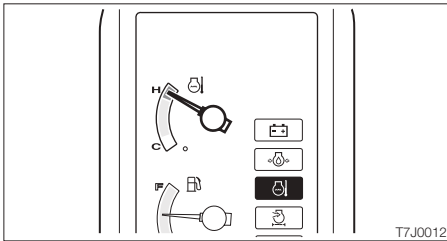

- An alarm is sounded and the coolant temperature warning lamp flashes.
- The coolant temperature gauge shows the red zone.
- The engine slows down and the power decreases.
- Steam comes from the engine compartment.

Procedure

1. Park the machine in a safe place.
2. Inspect whether the coolant temperature warning lamp is flashing or if there is steam coming out when the engine hood is closed.
3. If there is steam, stop the engine immediately and contact a Gehl dealer for repairs.
If the coolant temperature warning lamp is off, run the engine at low idle and let the coolant temperature decrease.
4. After the coolant temperature gauge drops to the green zone, stop the engine.
5. After the engine is cool, perform the following inspections and procedures:

- Fan belt slack Adjust.
Refer to page 125.
- Coolant level Add.
Refer to page 116.
- Coolant leakage Repair.
- Radiator fins Clean.
Refer to page 137.
- Sediment in cooling system Clean.
Refer to page 142.

If the problem persists after the above procedures are taken, contact a Gehl dealer for repairs.



The following symptoms indicate that the battery is dead:

- The starter motor does not turn or turns weakly, and the engine does not start.
- The horn is weak.

Procedure

Use jumper cables and start the engine using the rescue vehicle's battery.

WARNING

- **Use jumper cables only in the recommended manner. Improper use of jumper cables can result in battery explosion or unexpected machine motion.**
 - Do not let the problem machine and rescue vehicle touch each other.
 - Do not let the positive (+) and negative (-) clips of the jumper cables touch each other.
 - Connect the jumper cables to the positive (+) terminals first, and disconnect them from the negative (-) terminals (ground) first.
 - Connect the final clip of the jumper cable to a point as far away from the battery as possible.
- Use safety glasses when using jumper cables to start the machine.

IMPORTANT: Use jumper cables and clips of a size suited to the battery's capacity. Do not use damaged or corroded jumper cables and clips.

IMPORTANT: The rescue vehicle's battery must have the same capacity as the problem machine's battery.

IMPORTANT: Connect the clips securely.

Connecting the jumper cables

IMPORTANT: Set the ignition keys of both the rescue vehicle and problem machine to the OFF position.

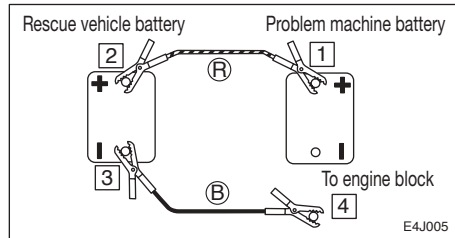

1. Connect the clip of jumper cable (R) to the problem machine's positive (+) terminal.
2. Connect the other clip of jumper cable (R) to the rescue vehicle's positive (+) terminal.
3. Connect the clip of jumper cable (B) to the rescue vehicle's negative (-) terminal.
4. Connect the other clip of jumper cable (B) to the problem machine's engine block. Connect the clip as far from the battery as possible.

Starting the engine

1. Check that the clips are securely connected to the terminals.
2. Start the rescue machine's engine and run it at high speed.
3. Start the problem machine's engine.

**Disconnecting the jumper cables**

After the engine starts, disconnect the jumper cables following the connection procedure in reverse order.

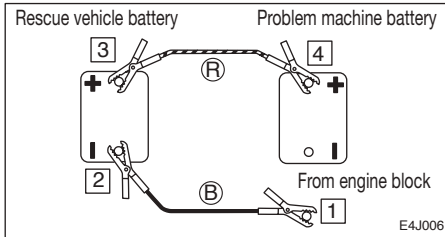

1. Disconnect the clip of jumper cable (B) from the problem machine's engine block.
2. Disconnect the other clip of jumper cable (B) from the rescue vehicle's negative (-) terminal.
3. Disconnect the clip of jumper cable (R) from the rescue vehicle's positive (+) terminal.
4. Disconnect the other clip of jumper cable (R) from the problem machine's positive (+) terminal.

Recharging

As necessary, have a Gehl dealer recharge any dead batteries.

Bleeding the Air from the Fuel System

IMPORTANT: NEVER use the starter motor to crank the engine in order to prime the fuel system. This may cause the starter motor to overheat and damage the coils, pinion and / or ring gear.

1. Add fuel.
2. Open the water separator valve (2).

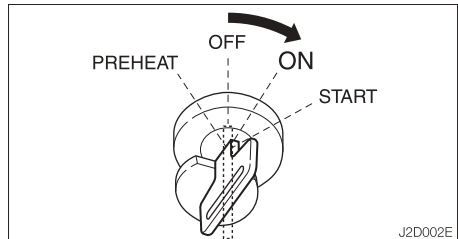

3. Turn the ignition key to the ON position and hold it there for about 10 to 15 seconds. The automatic air bleeder bleeds the air from the fuel system.
4. Start the engine and inspect for fuel leakage.

Note: Air in the fuel system can make it difficult to start the engine and cause engine problems. Also bleed the air when the fuel tank is emptied.



If a light does not turn on or the electric system does not operate, a fuse may be blown. Inspect the fuses.

Inspecting and Replacing Fuses

WARNING

If the fuse blows as soon as it is replaced, there is a problem with the electric system. Continued use may lead to fire. Consult a Gehl dealer.

1. Turn the ignition key to the OFF position and stop the engine.

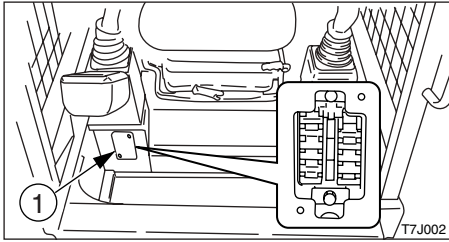

2. Open the fuse box cover (1).
3. Inspect for any blown fuses.

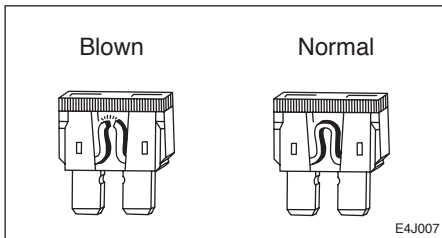

4. If a fuse is blown, replace it with a spare fuse of the same capacity.

Fuse Layout and Circuits Protected

< CTL55 / CTL65 / CTL75 >

Capacity	Protected circuit	Capacity	Protected circuit
15A	Front light		
30A	Lever lock, Radio (ACC)		
10A	Instrument cluster	30A	Air conditioner (OPT)
10A	Immobilizer (ACC)	20A	Reserve Multifunction
5A	Controller service tool	10A	Reverse alarm
10A	Feed pump, Sensor	15A	Rear light
10A	Controller	15A	Main relay
5A	Ignition switch	20A	External power socket (OPT)
10A	Solenoid	10A	Horn, Radio (Spare)
20A	Wiper (OPT)	10A	Immobilizer (Spare)

< CTL85 >

Capacity	Protected circuit	Capacity	Protected circuit
30A	Air conditioner, External power socket (OPT)		
20A	Rear light	20A	Reserve Multifunction
20A	Front light	20A	Instrument cluster
30A	Lever lock, Solenoid, Radio (ACC)	10A	Safety relay, Air heater controller
10A	Rear wiper (OPT)	30A	Stop solenoid
10A	Front wiper (OPT)	20A	Horn, Radio (B)



Inspecting the Fusible Link

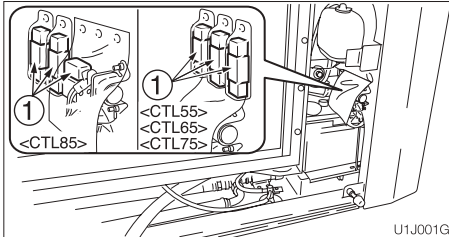





If the power is not switched on after turning the ignition switch to the ON position, the cartridge type fusible links (1) might be blown. Open the rear door and inspect. If the fusible link is blown, please contact your dealer.

Note: A fusible link is a large piece of fuse wiring that is mounted in a circuit that carries a large electrical current. Like a regular fuse, the fusible link protects the electrical parts and wiring from damage due to abnormally large currents.

**If a Warning Lamp Flashes**

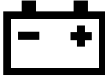
If an alarm is sounded or a warning lamp starts flashing during operation, park the machine in a safe place and perform the procedures described below.

Warning lamp	Lamp name	Procedure
 OS0B070	Engine oil pressure warning lamp	Inspect the engine oil level. If the lamp is flashing even though the levels are normal or if it continues flashing after oil added, consult a Gehl dealer. Refer to page 117, "Inspecting and Replenishing the Engine Oil."
 C4B012	Coolant temperature warning lamp	This indicates the coolant temperature has risen irregularly and the engine is overheating. Refer to page 157, "If the Engine Overheats."
 OS0B080	Battery charge warning lamp	This indicates there is a problem with the fan belt or charger. Inspect the fan belt for slack or breakage and adjust as necessary. If the lamp continues flashing after maintenance, there is a problem with the charger. Consult a Gehl dealer. Refer to page 125, "Inspecting and Adjusting the Fan Belt."
 G4B010	Air cleaner warning lamp	This indicates the air cleaner filter is clogged. If the air cleaner warning lamp lights, replace the elements immediately. Refer to page 136, "Replacing the Air Cleaner Elements".



Warning lamp	Lamp name	Procedure
 T7B008	Pilot line filter warning lamp	<p>This indicates the hydraulic oil pilot line filter is clogged. Stop the engine and replace the filter.</p> <p>Replace the filter immediately if the lamp flashes. Refer to page 126, "Replacing the Pilot Line Filter."</p> <p>IMPORTANT: Continuing to operate the machine while the lamp is lit could damage the line filter and hydraulic equipment.</p> <p>Cold weather operation: Hydraulic oil is not heated. Refer to page 75, "Warming up the hydraulics."</p>



For symptoms not included on the table below or if the problem persists after the proper procedures have been taken, consult a Gehl sales or service outlet.

Symptoms	Main cause	Procedure
Left and right control levers do not move smoothly	<ul style="list-style-type: none">● Insufficient grease on left and right control levers	<ul style="list-style-type: none">● Add grease. Refer to page 150.
Lift arms, bucket, auxiliary hydraulics or traveling operation not possible	<ul style="list-style-type: none">● Safety bar is raised● Fuse is blown	<ul style="list-style-type: none">● Lower the safety bar. Refer to page 59.● Replace the fuse. Refer to page 160.
Scooping or lifting force is insufficient	<ul style="list-style-type: none">● Insufficient hydraulic oil level● Hydraulic oil is not heated● Air cleaner is clogged● Hydraulic oil is not of suitable type	<ul style="list-style-type: none">● Replenish to the prescribed level. Refer to page 119.● Perform the warm-up procedure. Refer to page 75.● Replace the air cleaner. Refer to page 136.● Replace the hydraulic oil. Refer to page 144.
Traveling is not possible or not smooth	<ul style="list-style-type: none">● Stones or foreign objects are stuck	<ul style="list-style-type: none">● Remove the foreign object.
Machine does not travel straight forward	<ul style="list-style-type: none">● Stones or foreign objects are stuck	<ul style="list-style-type: none">● Remove the foreign object.
Operation is not possible with the various switches	<ul style="list-style-type: none">● Fuse is blown● Safety bar is raised	<ul style="list-style-type: none">● Replace the fuse. Refer to page 160.● Lower the safety bar. Refer to page 59.
Travel speed cannot be changed	<ul style="list-style-type: none">● Fuse is blown	<ul style="list-style-type: none">● Replace the fuse. Refer to page 160.
Hydraulic oil temperature is too high	<ul style="list-style-type: none">● Insufficient hydraulic oil	<ul style="list-style-type: none">● Replenish to the prescribed level. Refer to page 119.



Symptoms	Main cause	Procedure
Starter motor turns but engine does not start	<ul style="list-style-type: none">● Insufficient fuel● Air in fuel system● Water in fuel system	<ul style="list-style-type: none">● Add fuel. Refer to page 118.● Bleed the air. Refer to page 159.● Drain the water. Refer to page 132.
Crawlers slip off	<ul style="list-style-type: none">● Crawlers are too loose	<ul style="list-style-type: none">● Adjust the tension. Refer to page 128.
Engine exhaust is white or bluish	<ul style="list-style-type: none">● Excessive engine oil● Insufficient fuel	<ul style="list-style-type: none">● Adjust to the prescribed level. Refer to page 117.● Replace the fuel.
Engine exhaust is occasionally black	<ul style="list-style-type: none">● Air cleaner is clogged	<ul style="list-style-type: none">● Replace the air cleaner. Refer to page 136.
Irregular noise is produced from the engine (combustion or mechanical noise)	<ul style="list-style-type: none">● Low quality fuel is being used● Engine is overheating● Damage in muffler	<ul style="list-style-type: none">● Replace the fuel.● If the Engine Overheats Refer to page 157.● Replace the muffler. (Request at a Gehl dealer.)

**To Lower the Lift Arms**

If the lift arms must be lowered to the ground while the engine is stopped, use the following procedure to do so.

WARNING: This operation is dangerous and requires experience. Have it performed by a Gehl dealer.

Procedure**! WARNING**

- **Do not approach the area where the lift arms are to be lowered. You may be hit by dirt falling out of the bucket or the lift arms as it drops.**
- **Turn the port relief valve's set screw slowly so that the lift arms lowers slowly. Do not turn the screw more than the specified amount.**

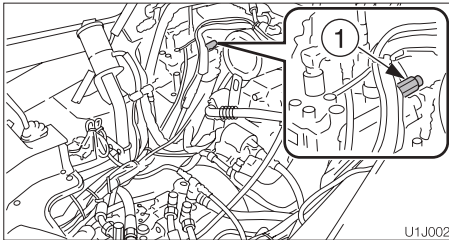
< CTL55 / CTL65 / CTL75 >

U1J002

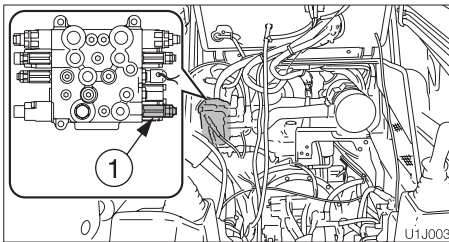
< CTL85 >

U1J003

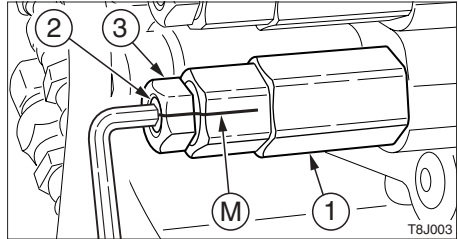

T8J003

2. Put mark (M) on the plug of the port relief valve (1) and set screw (2).
3. Gripping the set screw (2) with a hexagonal wrench so that it does not turn together with the lock nut (3), loosen the lock nut (3).
4. Turn the set screw (2) slowly 1 and 1/2 turns to lower the lift arms.
5. Check for safety and machine stability.
6. Turn the set screw (2) back to its original position.
7. Gripping the set screw (2) with a hexagonal wrench so that it does not turn together with the lock nut (3), tighten the lock nut (3).
Tightening torque:
 $20 \pm 1 \text{ N}\cdot\text{m}$ ($14.5 \pm 0.7 \text{ ft}\cdot\text{lb.}$)
8. Lower the ROPS.

1. Tilt up the ROPS.

**! WARNING**

When towing, selecting the wrong wire rope, inspecting improperly, or towing incorrectly could lead to accidents, resulting in serious injury or death.

- The wire rope breaking or detaching could be extremely dangerous. Use a wire rope suitable for the required tractive force.
- Do not use a wire rope that is kinked, twisted or otherwise damaged.
- Do not apply strong loads abruptly to the wire rope.
- Use safety gloves when handling the wire rope.
- Make sure there is an operator on the machine being towed as well as on the machine that is towing.
- Never tow on slopes.
- Do not let anyone near the wire rope while towing.

Towing the Machine

Use the procedure described below to tow light weight objects or the machine itself if it is stuck in the mud and not able to get out on its own.

IMPORTANT: Do not tow a machine if its engine does not start or if the machine does not run. Doing so could damage the machine being towed.

IMPORTANT: Be sure to follow all the steps below closely when towing. Failure to heed even one of the steps may cause damage to the hooks (1).

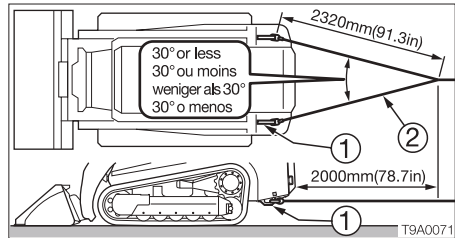

- Maximum tractive force
CTL55: 42.0 kN (9450 lbf) or less
CTL65: 56.8 kN (12780 lbf) or less
CTL75: 68.4 kN (15370 lbf) or less
CTL85: 78.9 kN (17750 lbf) or less

1. Attach the wire ropes (2) to the hooks (1) as shown in the figure.
2. Make the wire rope horizontal and line up straight with the travel frame.
3. Move the machine to tauten the wire rope.
4. Move the machine slowly and tow.

Applicable machine models

CTL55: 222000440 or later
CTL65: 223000838 or later
CTL75: 224000543 or later
CTL85: 225000633 or later



SPECIFICATIONS

Main Specifications	170
Machine Dimensions.....	174
Operating Range	176



CTL55

TYPE		ROPS	CAB
MASS			
Machine mass kg (lb.) (not including operator)	Rubber tracks	2720 (5995)	2780 (6130)
PERFORMANCE			
Bucket capacity m ³ (cu.ft.) (standard bucket)	Heaped		0.298 (10.52)
	Struck		0.223 (7.88)
Travel speed km/h (mph)	Rubber tracks	1st	6.5 (4.04)
		2nd	9.3 (5.78)
Gradeability (degrees)		30	
Ground pressure kPa (psi)	Rubber tracks	32.1 (4.65)	32.8 (4.75)
Noise level dB (A) <For EU>	Sound-power level		L _{WA} 103
	Sound-pressure level		L _{pA} 81
ENGINE			
Manufacturer and model		Yanmar 4TNV84T-ZKTBL	
Rated output	kW / min ⁻¹ (hp / rpm)	38.2 / 2800 (51.2 / 2800)	
Displacement	ml (cu.in.)	1995 (121.7)	
Starter	V - kW	12 - 2.3	
Alternator	V - kW	12 - 0.48	
Battery	V - A·h	12 - 72	

**CTL65**

TYPE		ROPS	
MASS			
Machine mass	kg (lb.)	Rubber tracks	3635 (8015)
PERFORMANCE			
Bucket capacity m ³ (cu.ft.) (standard bucket)	Heaped		0.351 (12.4)
	Struck		0.260 (9.18)
Travel speed	km/h (mph)	Rubber tracks	
		1st	7.3 (4.54)
		2nd	10.9 (6.77)
Gradeability (degrees)			30
Ground pressure	kPa (psi)	Rubber tracks	35.7 (5.18)
Noise level <For EU>	dB (A)	Sound-power level	L _{WA} 103
		Sound-pressure level	L _{pA} 85
ENGINE			
Manufacturer and model			Yanmar 4TNV98-ZNTBL
Rated output	kW / min ⁻¹ (hp / rpm)		50.1 / 2500 (67.1 / 2500)
Displacement	ml (cu.in.)		3319 (203)
Starter	V - kW		12 - 3.0
Alternator	V - kW		12 - 0.48
Battery	V - A·h		12 - 80



CTL75

TYPE		ROPS	
MASS			
Machine mass	kg (lb.)	Rubber tracks	4400 (9700)
(not including operator)			[4450 (9810)]*
PERFORMANCE			
Bucket capacity m ³ (cu.ft.) (standard bucket)	Heaped		0.458 (16.17)
	Struck		0.335 (11.8)
Travel speed	km/h (mph)	Rubber tracks	1st
			2nd
			7.6 (4.72)
			11.6 (7.21)
Gradeability (degrees)			30
Ground pressure kPa (psi)	Rubber tracks		28.9 (4.2)
			[28.8 (4.18)]*
Noise level <For EU>	dB (A)	Sound-power level	L _{WA} 104
		Sound-pressure level	L _{pA} 85
ENGINE			
Manufacturer and model			Yanmar 4TNV98T-ZNTBL
Rated output	kW / min ⁻¹ (hp / rpm)		61.9 / 2500 (83 / 2500)
Displacement	ml (cu.in.)		3319 (203)
Starter	V - kW		12 - 3.0
Alternator	V - kW		12 - 0.48
Battery	V - A·h		12 - 80

* [] : for High-flow hydraulic system

**CTL85**

TYPE		ROPS	
MASS			
Machine mass	kg (lb.)	Rubber tracks	5090 (11220) [5155 (11365)]*
PERFORMANCE			
Bucket capacity m ³ (cu.ft.) (standard bucket)	Heaped		0.579 (20.45)
	Struck		0.426 (15.04)
Travel speed	km/h (mph)	Rubber tracks	
		1st	7.8 (4.85)
		2nd	12.0 (7.46)
Gradeability (degrees)			30
Ground pressure kPa (psi)	Rubber tracks		31.0 (4.5) [31.6 (4.58)]*
	Noise level <For EU>	Sound-power level	
Sound-pressure level		L _{pA} 85	
ENGINE			
Manufacturer and model			KUBOTA V3800DI-T-E3B-TLTU-1
Rated output	kW / min ⁻¹ (hp / rpm)		68.3 / 2600 (91.6 / 2600)
Displacement	ml (cu.in.)		3769 (230)
Starter	V - kW		12 - 3.0
Alternator	V - kW		12 - 0.72
Battery	V - A·h		12 - 92

* [] : for High-flow hydraulic system

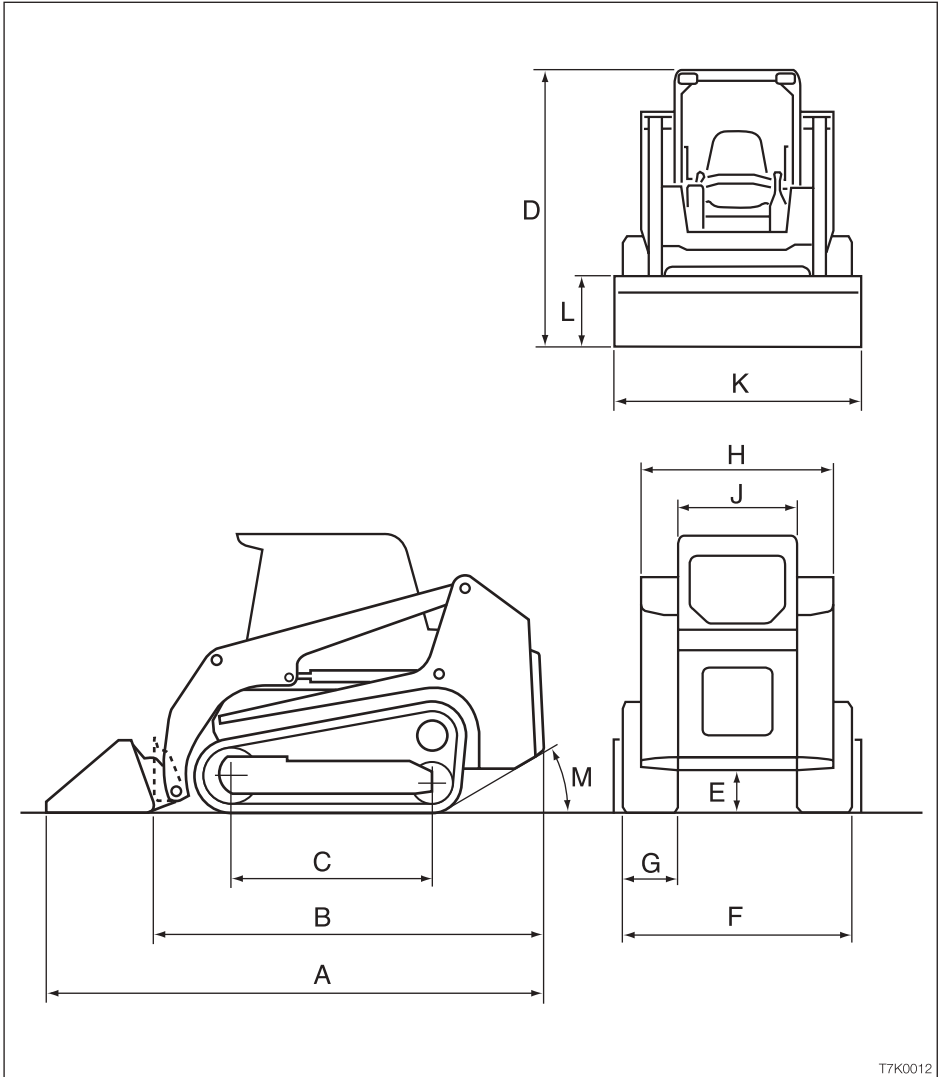

T7K0012



SPECIFICATIONS

Machine Dimensions

Units: mm (inches)

	CTL55	CTL65	CTL75	CTL85
	Standard Bucket			
	Rubber Tracks			
A	3220 (126.9)	3430 (135.1)	3740 (147.2)	3985 (156.9)
B	2580 (101.7)	2740 (107.8)	2980 (117.3)	3135 (123.5)
C	1240 (48.9)	1390 (54.7)	1495 (58.9)	1595 (62.9)
D	1970 (77.6)	2130 (83.9)	2270 (89.4)	2320 (91.3)
E	250 (9.8)	310 (12.1)	325 (12.8)	345 (13.5)
F	1470 (57.9)	1580 (62.2)	1770 (69.7)	1860 (73.2)
G	300 (11.8)	320 (12.6)	450 (17.7)	450 (17.7)
H	1360 (53.5)	1430 (56.3)	1500 (59.1)	1570 (61.8)
J	925 (36.4)	980 (38.6)	985 (38.7)	985 (38.7)
K	1600 (63)	1675 (66.0)	1880 (74.0)	1960 (77.2)
L	495 (19.5)	510 (20.0)	535 (21.1)	580 (22.8)
M	30°	30°	30°	30°

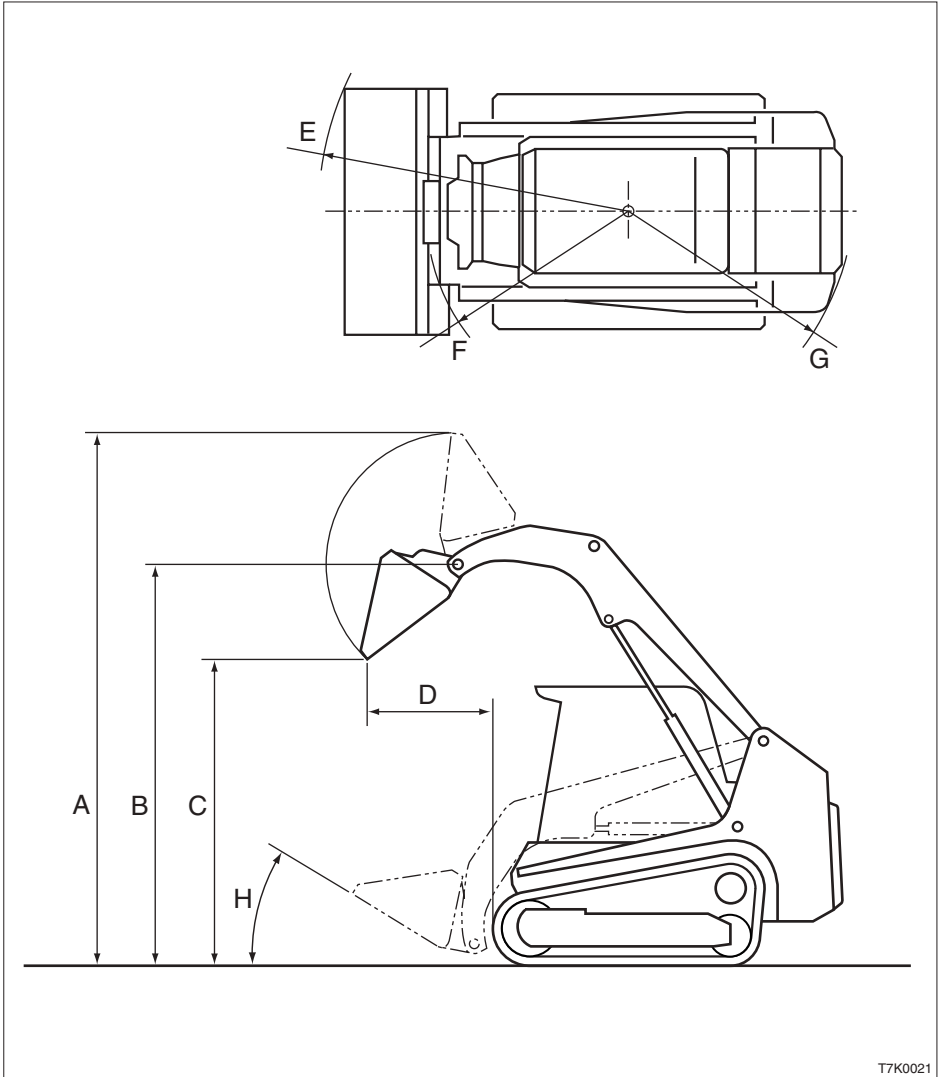

T7K0021



SPECIFICATIONS

Operating Range

Units: mm (inches)

	CTL55	CTL65	CTL75	CTL85
	Standard Bucket			
	Rubber Tracks			
A	3725 (146.7)	3905 (153.8)	4080 (160.7)	4245 (167.2)
B	2905 (114.4)	3030 (119.3)	3120 (122.9)	3205 (126.1)
C	2275 (89.5)	2370 (93.4)	2405 (94.8)	2430 (95.7)
D	590 (23.1)	730 (28.8)	875 (34.4)	985 (38.8)
E	1995 (78.6)	2080 (82.0)	2295 (90.4)	2435 (95.8)
F	1320 (52)	1375 (54.1)	1500 (59.1)	1560 (61.4)
G	1470 (57.9)	1590 (62.7)	1670 (65.7)	1755 (69.1)
H	30°	30°	31°	31°



OPTIONS

General Precautions	180
Air Conditioner < CTL55 >	182



Precautions on Safety

WARNING

Heed the following when removing or installing an attachment or option:

- Consult with a Gehl dealer before installing optional attachments.
 - Do not use attachments that have not been approved by Gehl. Doing so may compromise safety or adversely affect the machine's operation or service life.
 - Gehl will not be held responsible for any injuries, accidents or damage to products caused by the use of a non-approved attachment.
 - Choose a flat, hard surface to perform the operations. Also make sure there is enough light and good ventilation.
 - Clean the area, remove any articles that may get in the way or be dangerous, and remove any spilled oil or grease.
 - When removing or installing a backhoe attachment, place it in a stable position so that it does not tip over.
 - Due to the risk of loads falling and/or hitting people, do not allow unauthorized personnel in the work area.
 - Use a crane to carry heavy objects [25 kg (55 lb.) or greater].
 - When removing heavy parts, be sure to prop them up before removing them. When lifting them with a crane, be careful to balance them properly.
 - Operating with loads suspended with the crane is dangerous. Place loads on a stand and check for safety.
 - When attaching the attachments, failure to follow proper procedures could result in serious damage. Consult a Gehl dealer beforehand.
-

Precautions on Installing Attachments

After replacing optional attachments or other special attachments, test-run them, then inspect the hydraulic oil level and add oil if necessary.

In addition, consult a Gehl dealer for details of removal and installation procedures.

**Precautions on Operating Attachments****! WARNING**

Long attachments reduce machine stability. When traveling down steep slopes or turning on slopes, the machine may lose its balance and tip over. The following operations are particularly dangerous. Do not perform them.

- Traveling down slopes with the attachment lifted
- Traveling across slopes
- Turning on slopes

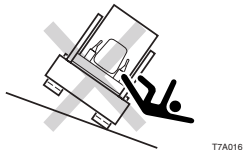
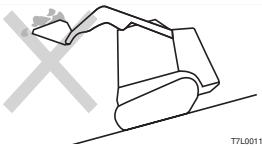

- When heavy attachments are installed, the overrun (the distance from where the control movement to stop traveling is performed until traveling stops completely) increases, and mistakes in judgment may result in the attachment hitting surrounding objects. Allow for plenty of room between the attachment and obstacles. In addition, the natural drop (the gradual dropping of the attachment under its own weight when it is stopped in midair) also increases when heavy attachments are installed.



CAUTIONS ON USE

Ventilate periodically

- When using the air conditioner over an extended period of time, open the windows about once each hour to let in fresh air.
- Your eyes may become irritated if you smoke while using the air conditioner. If this happens, open the windows to let in fresh air. Cigarette smoke particularly irritates the eyes when using the air conditioner because the humidity in the cabin drops and the eyes' membranes tend to become dry.

Always maintain good visibility

Working with the windows dirty or fogged restricts visibility and is dangerous. Always clean dirt and moisture off the windows before working.

- The windows tends to get foggy when the humidity is high. If this happens, turn on the air conditioner and use outside air and the defroster to get rid of the fog.
- If the air conditioner is set too high when using the defroster, the difference between the external and internal temperatures increases, and fog may form on the outside of the windows. If this happens, either turn off the air conditioner or turn the temperature control dial clockwise to increase the inside temperature.
- Mist may blow out of the air outlets. This is not a malfunction. When moist air passes through the air conditioner unit's evaporator, water particles in the air freeze and are emitted as mist.

Do not overcool

For health purposes, the air inside the cab should be kept at a temperature at which you feel a little cool when entering the cab from outside [a difference of 5 to 6°C (9 to 11°F)]. Be careful to adjust the temperature properly.

Do not turn the air conditioner on until the engine is started

To avoid placing an excessive load on the compressor, wait until the engine is started and is running smoothly before turning on the air conditioner.

Let hot air out first

If the loader has been parked in the sun, open the windows or door to let the hot air out of the cab before using the air conditioner.

Caution on refrigerant (gas)

Exposure of the eyes or hands to the air conditioner's refrigerant could result in blindness or frostbite. Never touch the refrigerant or loosen the parts of the cooling circuit.

If the refrigerant gas leaks, keep flames away.



NAMES OF COMPONENTS

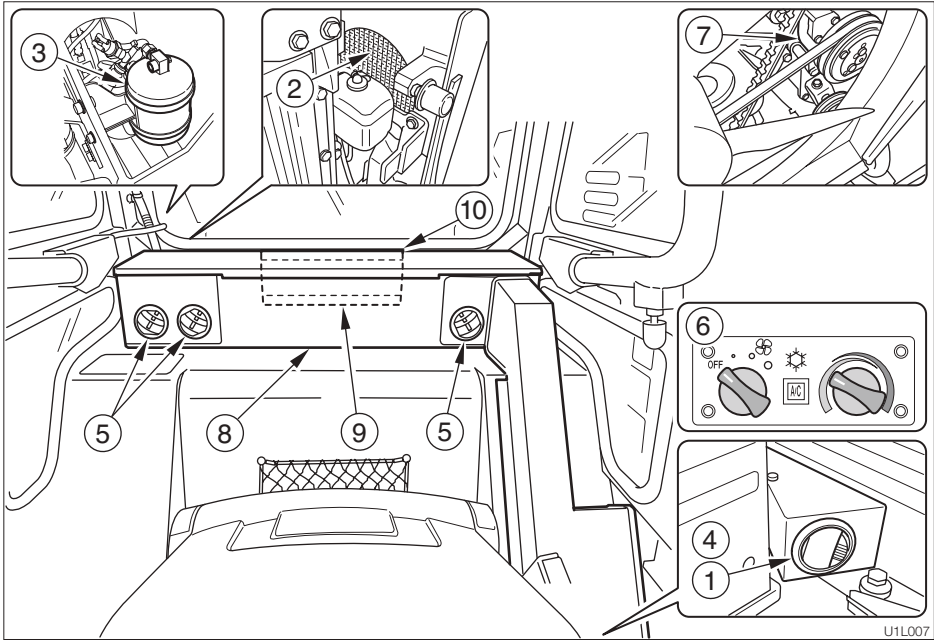

1. Defroster
2. Condenser
3. Receiver drier
4. Foot outlets
5. Rear outlets
6. Control panel
7. Compressor
8. Air conditioner unit
9. Inner filter
10. Outer filter

Control Panel

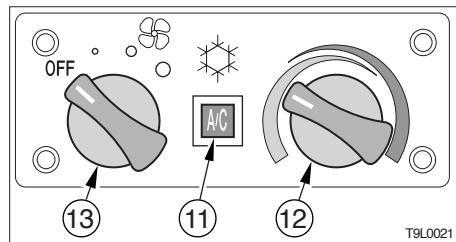

11. Air conditioner switch
12. Temperature control dial
13. Fan switch



Air Conditioner Switch

IMPORTANT: To avoid placing an excessive load on the compressor, wait until the engine is started and is running smoothly before turning on the air conditioner.

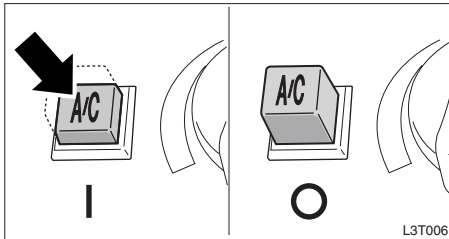

Use this switch to turn the air conditioner ON and OFF. When this switch is pressed while the engine is running and the fan switch is ON, the air conditioner turns on. Press the switch again or turn the fan switch OFF to stop the air conditioner.

O.....OFF

I.....ON

Note: To prevent leakage of refrigerant gas from the compressor's seal, operate the air conditioner at least once a week, regardless of the season.

Note: The air conditioner will not function if the temperature in the cab is too low [about 3°C (38°F) or lower].

Temperature Control Dial

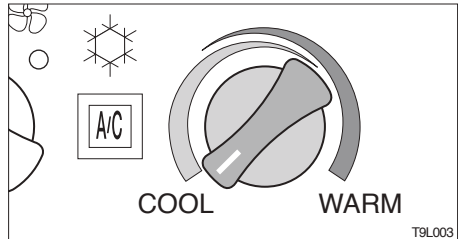

Use this dial to adjust the air temperature.

COOL..... To lower the temperature

WARM..... To increase the temperature

Note: No warm air is emitted if the temperature of the engine coolant is low.

Fan Switch

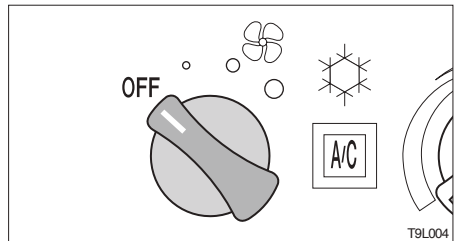

Use this switch to adjust the fan speed in three steps. At the OFF position, the air conditioner is also OFF.

OFF Fan and air conditioner off

• Low

○ Medium

○ High



Outlets

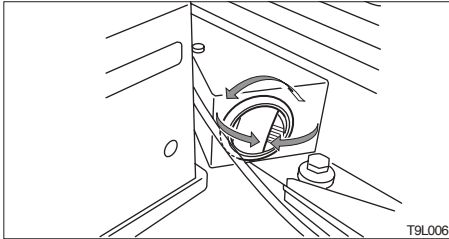

Move the louvers up and down or left and right to adjust the air flow direction and amount.

OPERATION

**Heating and Dehumidifying
(in cold weather or when the humidity is high)**

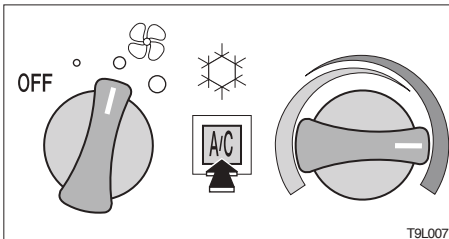

After starting the engine, turn the air conditioner ON and adjust the switches as shown in the diagram above. The outflow slot of the defroster can be directed at the cab door. Warm, dehumidified air blows on the cab door, preventing fogging. Set the temperature control dial and fan switch to the desired positions.

Cooling

⚠ CAUTION

- Excessive cooling can be harmful to your health. It is best to keep the air inside the cab only about 5 to 6°C (9 to 11°F) cooler than the outside air.
- If the loader has been parked in the sun, open the windows or door to let the hot air out of the cab before using the air conditioner.

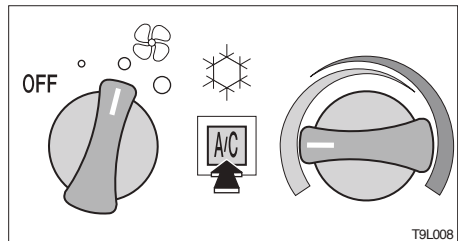

After starting the engine, turn the air conditioner ON and adjust the switches as shown in the diagram above. Set the temperature control dial and fan switch to the desired positions.

Quick cooling

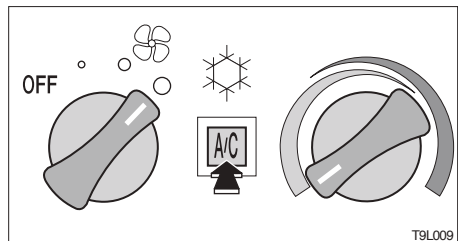

To cool the cab quickly, set the temperature control dial to Cool and the fan switch to High, as shown on the diagram above.



OPTIONS

Air Conditioner < CTL55 >

Defogging the Windows

CAUTION

If the air conditioner is set too high when using the defroster, the difference between the outside and inside temperatures increases, and fog may form on the outside of the windows. If this happens, either turn the air conditioner OFF or turn the temperature control dial clockwise (WARM).

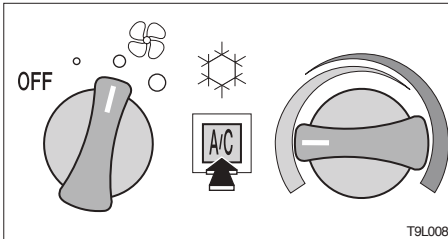

After starting the engine, turn the air conditioner ON and adjust the switches as shown in the diagram above.

The outflow slot of the defroster can be directed at the cab door.



INSPECTION AND MAINTENANCE

Inspection and maintenance interval
.....Every 250 hours

Cleaning the Condenser

IMPORTANT: Cleaning the condenser with high pressured water may damage it. Clean the condenser gently.

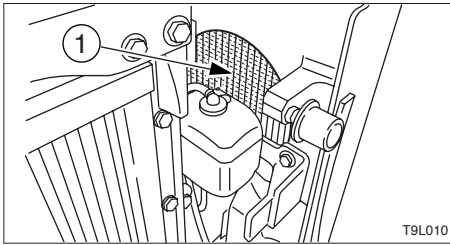

If the condenser is dirty, heat will not discharge properly. Wash dirt off the condenser with water.

1. Open the rear door.
2. Clean the condenser (1).

Inspecting and Adjusting the Air Conditioner Belt

IMPORTANT: Do not let any oil or grease get on the belt, because it will cause the belt to slip, shortening its service life and reducing the air conditioner's cooling capacity.

If the belt is slack, it will slip and vibrate, shortening its service life and reducing the air conditioner's cooling capacity. The belt should also not be too tight. Adjust the belt tension to the standard value (approximately 8 mm or 0.3 in.).

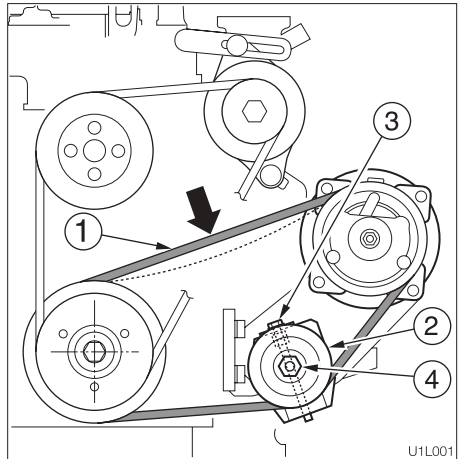
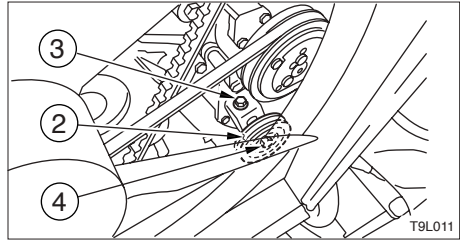

Inspection

1. Open the radiator door.
2. Press on the center of the belt (1) with a finger. The belt's tension is normal if it deflects about 8 mm (0.3 in.) when pressed with a force of about 98 N (22 lbs.).

Adjustment

If the belt's tension is not normal, adjust it with the adjust bolt (3).

1. Loosen the nut (4).
2. Tighten the bolt (3) to decrease the tension.
Loosen the bolt (3) to increase the tension.
3. After adjusting is completed, tighten the nut (4).



Replace

Replace the belt in the following cases:

- If it stretches and its tension cannot be adjusted.
- If it is cut or cracked.
- If the fan belt is worn and the pulley is touching the bottom of the V-groove.

Cleaning the Filter

Clean the filter more often when operating in dusty places.

If the filter is clogged, the air becomes weak and a muted booming sound is heard from the air conditioner unit.

Removing the filters

Outer filter

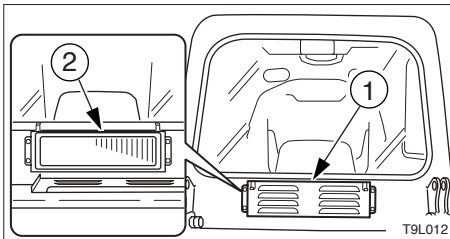

1. Remove the cover (1).
2. Remove the filter (2).

Inner filter

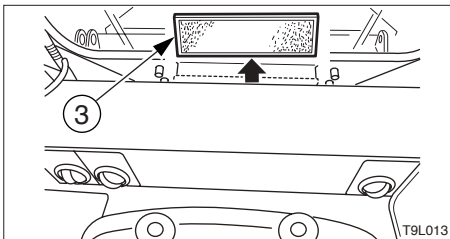

1. Lift the filter (3) upwards and off.
2. Use compressed air or water to clean the filter, depending on how dirty it is.

Cleaning



CAUTION

Wear safety glasses when using compressed air.

1. Blow dry, compressed air [138 kPa (20 psi) or less] directly on the filter from the inside, moving up and down along the creases.
Be sure to keep the nozzle at an adequate distance from the filter.
2. For difficult-to-remove dirt, wash the filter (3) with neutral detergent and water. Dry the filter (3) completely after washing it.

Inspecting the Refrigerant (gas) Level



WARNING

Exposure of the eyes or hands to the cooler's refrigerant could result in blindness or frostbite. Never touch the refrigerant or loosen the parts of the cooling circuit.

If the refrigerant gas leaks, keep flames away.

The cooling capacity will decrease if the amount of refrigerant is insufficient.

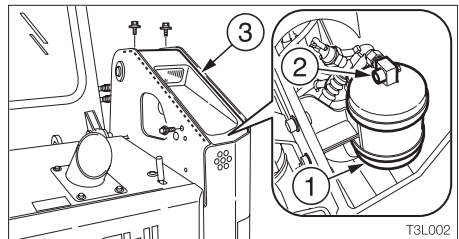

1. Loosen the bolts and remove the cover (3).



Inspect the refrigerant level using the sight glass (2) on the top of the receiver drier (1).

2. Inspect under the following conditions:
 - Cab doorFully open
 - Temperature control dial
Fully to the COOL side
 - Air strengthHigh
 - Engine speed 1500 rpm
 - Air conditionerOn
3. Inspect by watching the flow of air bubbles in the refrigerant through the sight glass (2). Refer to page 190, "Condition of the refrigerant."

⚠ CAUTION

The high pressure pipe becomes hot [80 to 120°C (176 to 248°F)], so be careful not to burn yourself when inspecting the refrigerant level.

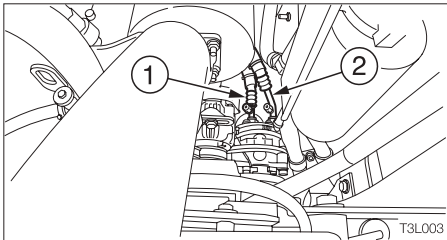

4. Open the radiator.
Refer to page 125, "Inspecting and Adjusting the Fan Belt."
5. Also check the temperature of the compressor's high pressure pipe (1) and low pressure pipe (2). Refer to page 184, "Condition of the refrigerant."

Off-Season Inspection

Even off-season, run the cooler for 3 to 5 minutes at least once a week to maintain oil in the various parts of the compressor.

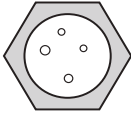
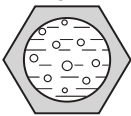
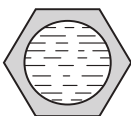
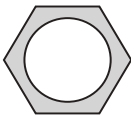

Condition of the refrigerant

Sight glass (refrigerant)		High/low pressure pipe temperature	Pipe connection
<p>Normal</p> 	<p>Almost transparent, with some bubbles, but fully transparent when the engine speed is increased or decreased.</p>	<p>High pressure pipe (1) hot [80 to 120°C (176 to 248°F)], low pressure pipe (2) cold [8 to 15°C (46 to 59°F)]. Clear difference in temperature between the pipes.</p>	<p>No irregularities.</p>
<p>Refrigerant low</p> 	<p>Flow of bubbles can be seen constantly. Refrigerant is sometimes transparent or has white bubbles. Refrigerant may be leaking.</p>	<p>High pressure pipe warm, low pressure pipe somewhat cool. No great difference in temperature between the pipes.</p>	<p>Some oily places.</p>
<p>Almost no refrigerant</p> 	<p>Some mist-like refrigerant can be barely seen flowing. Refrigerant has leaked, and almost none is left.</p>	<p>Almost no difference in temperature between the high and low pressure pipes.</p>	<p>Some heavily oily places.</p>
<p>Excess refrigerant</p> 	<p>No bubbles can be seen, even when the fan is set to high and the engine is idling.</p>	<p>High pressure pipe is hot, low pressure pipe is somewhat cool. There is a difference in temperature between the pipes.</p>	<p>No irregularities.</p>

If the air conditioner does not function

If the air conditioner does not cool or heat the air, set the fan switch to OFF and contact a Gehl dealer for inspection and/or repairs.

IMPORTANT: Continued use of the air conditioner when it is not functioning properly may damage its various parts.

IMPORTANT: Using the air conditioner when there is no refrigerant will damage the compressor. Be particularly careful not to do this.

IMPORTANT: Always have a Gehl dealer add or replace the refrigerant. Be sure to use R134a refrigerant [800 g or (1.76 lbs)].

MEMO



INDEX



A

Accessories	61
Adjusting or Replacing the Bucket Stoppers (bolts / nuts)	140
After Cold Weather is Over	91
After First 250 Hours (New Machines Only).....	135
After First 50 Hours (New Machines Only).....	122
After starting the engine.....	18
After the Fuel Runs Out	159
Air Conditioner < CTL55 >	182
Air Conditioner Switch	184
Always clean the machine	29
Always keep the machine clean.....	15
Always maintain good visibility.....	182
Anti-explosive lighting.....	28
Attach a "DO NOT OPERATE" tag.....	28
Auxiliary Hydraulic Lines.....	62
Auxiliary Hydraulic Switches	56
Avoid battery hazards	33
Avoid fire and explosion hazards	10
Avoid overloading and off-center loads.....	23

B

Be careful not to get crushed or cut	14
Be careful with fluids under pressure	32
Be careful with grease under pressure	32
Be careful with hot and pressurized components	31
Be careful with hot cooling systems	32
Be sure to raise the safety bar before leaving the operator's seat.....	9
Before Starting Operation.....	70
Before Starting the Engine.....	71
Bleeding the Air from the Fuel System	159

C

Cab Door < CTL55 >	42
Caution against falling unstable loads	22
Caution on refrigerant (gas)	182
Cautions after Completing Operations	91
Cautions on Maintenance.....	102
Cautions on Operating.....	84
Cautions on tilting up the ROPS	30
Cautions on towing.....	25
Cautions on Transporting	100
Cautions on traveling and turning	20
Cautions on traveling on slopes.....	21
Cautions on Traveling on Slopes.....	86
Check for safety in the surrounding area before starting.	19
Check the strength of the bridge	15
Checks after maintenance	34
Cleaning the Condenser	187
Cleaning the Condenser < CTL55 Option >.....	137
Cleaning the Engine Cooling System	142
Cleaning the Filter	188
Cleaning the Radiator Fins and Oil Cooler Fins	137
Cleaning the Water Separator	134
Clear the area of other persons before starting the machine	17
Condition of the refrigerant.....	190
CONTROLS.....	39
Cooling.....	185
Crush Hazard FOPS Limitations	9

D

Daily Inspection	70
Daily Inspection (Every 10 Hours)	116
Danger of flying objects	25
Defogging the Windows	186
Disconnect the battery	33
Disposing of wastes	34



Do not allow unauthorized personnel in the work area... 28
 Do not carry the bucket over the heads of people..... 22
 Do not drive into materials at high speeds 22
 Do not drive on soft ground..... 24
 Do not overcool..... 182
 Do not permit riders on the machine 19
 Do not suddenly stop or lower the working equipment... 23
 Do not turn the air conditioner on until the engine is
 started..... 182
 Doors and Covers 42
 Draining the Fuel Tank..... 132

E

Emergency Exit 16
 Emergency Exit 45
 Engine Fault Warning Lamp
 < CTL55 / CTL65 / CTL75 >..... 53
 Engine Hood..... 44
 Ensure good visibility 19
 Every 100 Hours..... 134
 Every 1000 Hours..... 142
 Every 1500 Hours..... 146
 Every 2000 Hours..... 147
 Every 250 Hours..... 136
 Every 3000 Hours..... 147
 Every 50 Hours..... 128
 Every 500 Hours..... 138
 Exhaust fumes from the engine can kill 13
 Expendables..... 106

F

Fan Switch..... 184
 Fire prevention..... 10
 Float Button 54
 Fuel Filler Cap..... 47

G

General 102
 General Precautions..... 8
 General Precautions..... 180

H

Handling asbestos dust..... 13
 Handling of hoses 31
 Handling of poisonous chemicals..... 34
 Have a Gehl technician repair weld cracks or
 other damage 34
 Heating and Dehumidifying
 (in cold weather or when the humidity is high) 185
 High-flow Hydraulic System (If Equipped)..... 63
 Hoisting the Machine 96
 Hoisting the machine safely 27
 Horn Button 54

I

If a Fuse Blows 160
 If a Warning Lamp Flashes 162
 If the Battery Goes Dead 158
 If the Engine Overheats..... 157
 Ignition Key 42
 Ignition Switch..... 54
 Important Parts..... 109
 In cold weather 18
 INDEX..... 193
 Indicators 53
 Inspecting and Adjusting the Air Conditioner Belt 187
 Inspecting and Adjusting the Air Conditioner Belt
 < CTL55 Option > 137
 Inspecting and Adjusting the Engine Valve Clearance... 146
 Inspecting and Adjusting the Fan Belt 125
 Inspecting and Adjusting the Fan Belt 137



Inspecting and Adjusting the Track Tension	128
Inspecting and Cleaning the EGR Valve, Lead Valve and Cooler	147
Inspecting and Cleaning the Engine Fuel Injectors	146
Inspecting and Replacing Fuses	160
Inspecting and Replenishing the Coolant	116
Inspecting and Replenishing the Engine Oil	117
Inspecting and Replenishing the Windshield Washer Fluid	150
Inspecting by Opening the Engine Hood and Rear Door	114
Inspecting by Walking Around the Machine	115
Inspecting the Battery Fluid Level and Replenishing	130
Inspecting the Bucket Stoppers (bolts / nuts)	133
Inspecting the Crankcase Breather System	146
Inspecting the Fuel Level	118
Inspecting the Fusible Link	161
Inspecting the Hydraulic Oil Level and Replenishing	119
Inspecting the Refrigerant (gas) Level	188
Inspecting the Rubber Tracks	152
Inspecting the Turbocharger (Blower wash as necessary) <CTL55 / CTL75 / CTL85>	147
Inspecting the Water Separator	117
Inspecting While Sitting in the Operator's Seat	115
Inspection After Warm-up	76
Inspection and Checks After Stopping the Engine	90
Instrument Panel	52
Interior Light (Option)	61
INTRODUCTION	2

K

Keep a safe distance from electrical power lines	23
Keep your body inside the operator's cab	19
Know the working area	15

L

Lapping the Engine Valve Seats	147
Left Control Lever	60
Let hot air out first	182
Lever Pattern	74
Levers and Pedals	59
Lift Arm Stop	46
Light Switches	58
Load and unload the machine safely	27
Loaders are NOT designed for lifting loads	25
Loading and Unloading	98
Long-term Storage	153
Lubricant and Fuel Chart	104
Lubricating the Levers	150
Lubricating the Working Equipment	120

M

MACHINE DESCRIPTION	3
Machine Dimensions	174
Machine Operation	74
Main Specifications	170
Maintain three-point contact when mounting and dismounting	17
MAINTENANCE	101
Maintenance Chart	110
Maintenance Description	102
Maintenance Log	112
Maintenance Precautions	28
Meters	53
Mounting and Dismounting	70



N

Names of Components	40
Never disassemble the track adjuster.....	33
Never modify the machine.....	14
Never remove safety equipment.....	9

O

Observe all safety rules.....	8
Off-Season Inspection.....	189
Operate on snow or ice with extra caution.....	22
Operate the machine only from the operator's seat.....	19
Operating in Cold Weather.....	91
Operating Precautions.....	19
Operating Procedures.....	82
Operating Range.....	176
Operating temperature range.....	8
Operating the Auxiliary Hydraulics.....	81
Operating the Left Control Lever.....	77
Operating the Right Control Lever.....	80
OPERATION.....	69
Operations Possible with this Machine.....	88
OPTIONS.....	179
Other Symptoms.....	164
Outlets.....	185

P

Park safely.....	26
Parking.....	90
Parking the Machine.....	90
Perform inspection and maintenance daily.....	16
Place heavy objects in a stable position.....	30
Precautions.....	93
Precautions on Installing Attachments.....	180
Precautions on Operating Attachments.....	181
Precautions on Safety.....	180

Precautions when passing through tunnels or near high walls.....	24
Prepare the work area.....	29
Preparing for Cold Weather.....	91
Preparing Precautions.....	15
Product usage.....	14
Prohibited Actions.....	92
Prohibited Operations.....	82
Provide a fire extinguisher and first aid kit.....	8

R

Rear Door.....	44
Release all pressure before working on the hydraulic system.....	32
Replace important safety parts periodically.....	28
Replacing the Air Cleaner Elements.....	136
Replacing the Bucket or Attachment.....	148
Replacing the Engine Oil and Oil Filter.....	123
Replacing the Engine Oil and Oil Filter.....	137
Replacing the Fuel Filter.....	138
Replacing the Hydraulic Oil and Cleaning the Suction Strainer.....	144
Replacing the Hydraulic Oil Return Filter.....	122
Replacing the Hydraulic Oil Return Filter.....	139
Replacing the Pilot Line Filter.....	126
Replacing the Pilot Line Filter.....	139
Replacing the Travel Motor Gear Oil.....	135
Replacing the Travel Motor Gear Oil.....	139
Retightening the Engine Cylinder Head Bolts.....	146
Right Control Lever.....	60

S

SAFETY.....	7
Safety Bar.....	59
Safety signs.....	34



Safety Signs (Decals)	35
Seat < CTL55 >	48
Seat < CTL65 / CTL75 / CTL85 >	50
Seat and Seat Belt	48
Seat Belt < CTL55 >	49
Seat Belt < CTL65 / CTL75 / CTL85 >	51
Secure the rear door when opened	30
Securely block the machine or any component that may fall	30
Securely block the raised lift arms	30
Securing the Machine	99
Service Data	104
Side Window < CTL55 >	43
SPECIFICATIONS	169
Start the engine from the operator's seat	17
Starting and Stopping the Engine	71
Starting Precautions	17
Starting the Engine	72
Starting with jumper cables	18
Stay clear of moving parts	29
Stop the engine before performing maintenance	29
Stopping Precautions	26
Stopping the Engine	73
Switches	54
Symptoms that Are Not Malfunctions	156

T

Temperature Control Dial	184
Throttle Lever	59
Throttle Pedal	59
Tightening Torques	108
Tilting Up the ROPS	151
To Lower the Lift Arms	166
Tools	107
Towing	167
TRANSPORT	95
Transport the machine safely	27

Transporting Precautions	27
Travel in narrow or congested places	24
Travel Speed Button	58
TROUBLESHOOTING	155

U

Use a signal person and flagman	9
Use caution when floating the lift arms	21
Use caution when fueling	31
Use the correct tools	28
Using optional products	14
Using Rubber Tracks	92

V

Ventilate periodically	182
Vibrations to which the operator is subjected	34

W

Walk-Around Inspection	70
Walk-Around Inspection	114
Warming Up the Engine	73
Warming Up the Hydraulics	75
Warning Lamps	52
Watch out for hazardous working conditions	24
Wear appropriate clothing and personal protective equipment	8
When Required	148
Wiper Switches (Option)	58

GEHL COMPANY WARRANTY

GEHL COMPANY, hereinafter referred to as Gehl, warrants new Gehl equipment to the Original Retail Purchaser to be free from defects in material and workmanship for a period of twelve (12) months from the Warranty Start Date.

GEHL WARRANTY SERVICE INCLUDES:

Genuine Gehl parts and labor costs required to repair or replace equipment at the selling dealer's business location.

GEHL MAKES NO REPRESENTATIONS OR WARRANTIES OF ANY KIND, EXPRESS OR IMPLIED (INCLUDING THE IMPLIED WARRANTIES OF MERCHANTABILITY AND FITNESS FOR PARTICULAR PURPOSE), EXCEPT AS EXPRESSLY STATED IN THIS WARRANTY STATEMENT.

ANY OF THESE LIMITATIONS EXCLUDED BY LOCAL LAW SHALL BE DEEMED DELETED FROM THIS WARRANTY; ALL OTHER TERMS WILL CONTINUE TO APPLY.

SOME STATES DO NOT PERMIT THE EXCLUSION OR LIMITATION OF THESE WARRANTIES AND YOU MAY HAVE GREATER RIGHTS UNDER YOUR STATE LAW.

GEHL WARRANTY DOES NOT INCLUDE:

1. Transportation to selling dealer's business location or, at the option of the Original Retail Purchaser, the cost of a service call.
2. Used equipment.
3. Components covered by their own non-Gehl warranties, such as tires, batteries, trade accessories and engines.
4. Normal maintenance service and expendable, high-wear items.
5. Repairs or adjustments caused by: improper use; failure to follow recommended maintenance procedures; use of unauthorized attachments; accident or other casualty.
6. Liability for incidental or consequential damages of any type, including, but not limited to lost profits or expenses of acquiring replacement equipment.

No agent, employee or representative of Gehl has any authority to bind Gehl to any warranty except as specifically set forth herein.

WARNING

**THIS OPERATOR'S MANUAL IS
PROVIDED FOR OPERATOR USE**

DO NOT REMOVE FROM THIS MACHINE

Do not start, operate or work on this machine until you carefully read and thoroughly understand the contents of this operator's manual.

Failure to follow safety, operating and maintenance instructions can result in serious injury to the operator or bystanders, poor operation, and costly breakdowns.

If you have any questions on proper operation, adjustment or maintenance of this machine, contact your dealer or the Gehl Company Service Department before starting or continuing operation.

California Proposition 65 Warning

Diesel engine exhaust and some of its constituents are known to the State of California to cause cancer and birth defects or other reproductive harm.

Battery posts, terminals and related accessories contain lead and lead compounds, chemicals known to the State of California to cause cancer and birth defects or other reproductive harm. Wash hands after handling battery.

GEHL®

Gehl Company 143 Water Street, P.O. Box 179, West Bend, WI 53095-0179 U.S.A.
www.gehl.com