



Small Grains

LEXION

780 760 750 740 730(P) 730
670

CLAAS



LEXION features.

Automatic Machine Optimization by
CRUISE PILOT and CEMOS AUTOMATIC

Spacious, Quiet, and Comfortable Cab

In-Cab Hydraulic HP Feederhouse
Pitch Adjustment

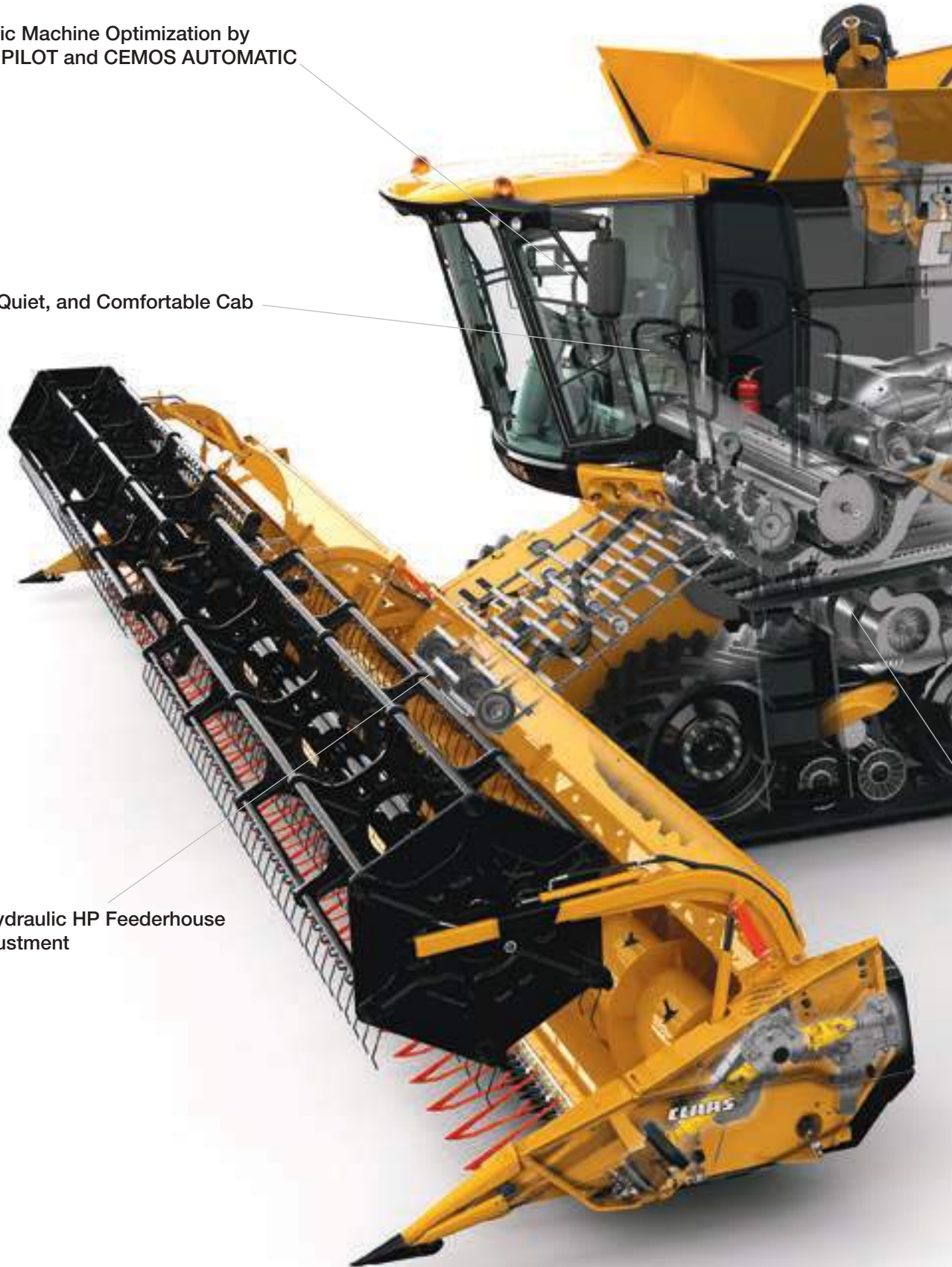

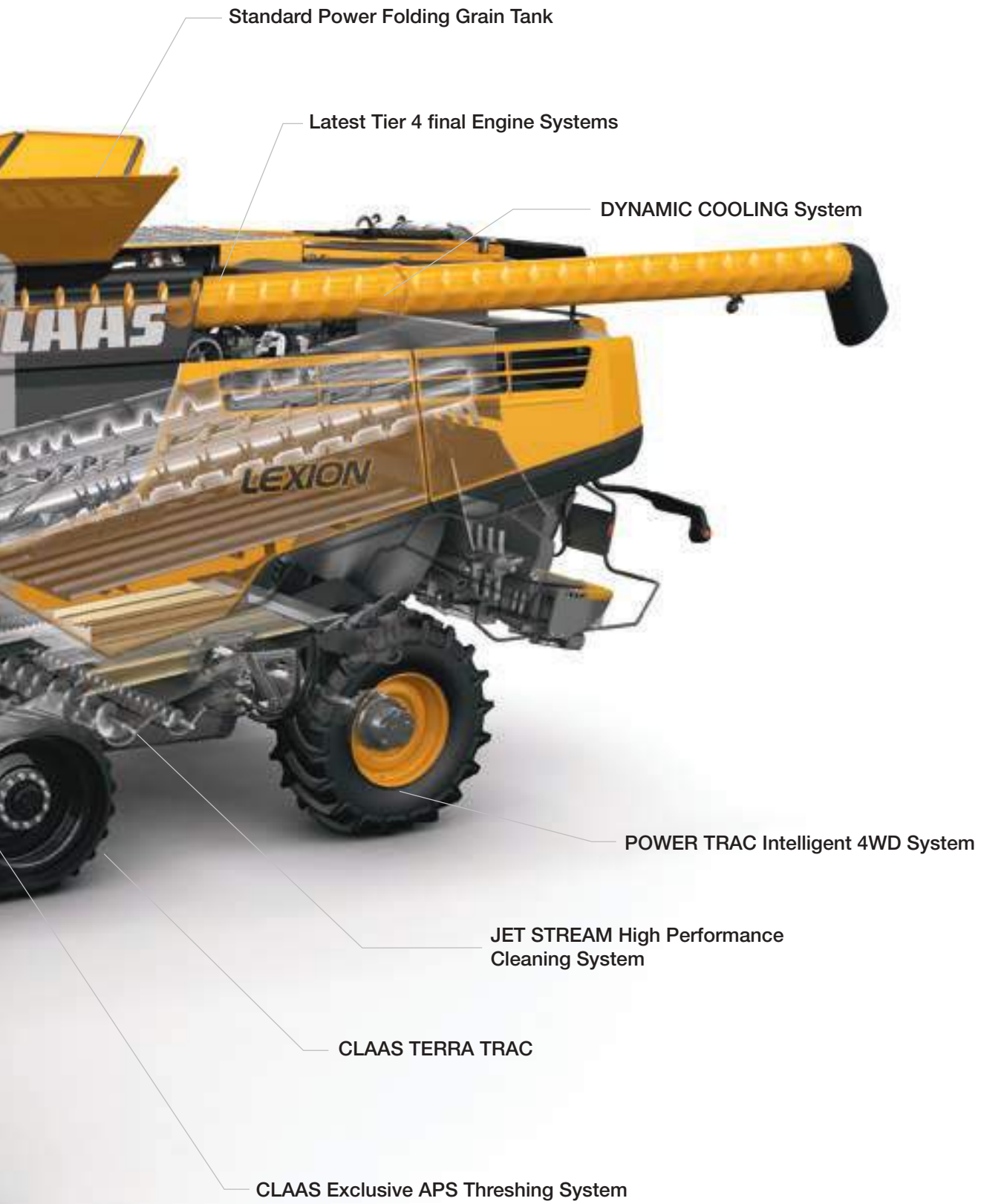

Standard Power Folding Grain Tank

Latest Tier 4 final Engine Systems

DYNAMIC COOLING System

POWER TRAC Intelligent 4WD System

JET STREAM High Performance
Cleaning System

CLAAS TERRA TRAC

CLAAS Exclusive APS Threshing System



Standard feederhouse.

The standard feederhouse is designed for all crops and features an extra large channel with a shallow angle that provides a smooth transition for the crop into the APS system for threshing.

A heavy duty 4-chain, 3-slat conveyor provides reliable transfer of the crop through the feederhouse. The conveyor chain rides on an adjustable front drum, and when it is in a down position, provides added protection against rocks and foreign debris.

Dual heavy-duty AUTO CONTOUR cylinders not only carry the header, they also provide lateral tilt compensation when operating in changing terrain.

Compatible with:

- All corn heads
- All rigid heads (VARIO, MAXFLO)
- F750 and F900 flex heads
- SWATH UP heads

HP feederhouse.

The HP feederhouse includes all of the same features as the standard feederhouse, plus an added header pitch (HP) adjustment to more easily adapt to changing field conditions along with a hydraulic chain tensioning system.

The HP feederhouse is equipped with the exclusive optional hydraulic top-link that allows the operator to make adjustments when desired from the cab to the header's pitch by simply adjusting the faceplate's exclusive top-link. The cutting angle offers 19 degrees of adjustability (11 degrees forward, 8 degrees back), and AUTO CONTOUR cylinders fitted within the HP faceplate provide 9 degrees of lateral tilt.

Compatible with:

- All header types



Unrivalled intake.

Dust suction fan.

An optional dust suction fan can be fitted to both the Standard or HP feederhouse to help prevent dust from obstructing the view of the operator. The turbine fan has a removable shroud for easy clean out and inspection of the fan unit.

Hydraulic reverser.

Reversing the feederhouse (and header) is done by a powerful hydraulic motor that can be engaged electronically from the cab without having to turn the separator off. When operating with a platform head, the reel will also reverse when the feederhouse reverser is engaged in order to prevent any expelled material from building up on the cutterbar.

Multi-Link Connector.

Make all seven electrical and hydraulic connections in one easy step with the Multi-Link Connector. The self-sealing hydraulic connections allow mess-free connection and disconnection, even while under pressure.

Header lock.

A single lever securely locks all platform heads to the combine feederhouse.

The header's vertical and lateral position is displayed in CEBIS.

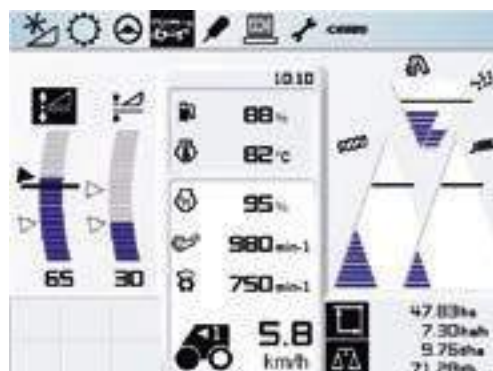

Consistent results in any field.

Header drive.

Reduce fuel consumption without reducing power – the direct header drive delivers maximum power to the header for the ever-increasing volume of material being passed through the feederhouse.

New feederhouse drive technology offers stronger, more efficient header drive output to meet the demands of larger heads:

Fixed speed: 107hp (80kW)

Variable speed (standard): 160hp (120kW)



Automatic soft start system.

Improved controlled engagement of the header drive system. The new drive system allows for part of the system to engage with the separator system to allow for softer starts and decreased load limits when the feederhouse is engaged.



CLAAS CONTOUR:
Consistency matters.

CLAAS CONTOUR is standard on all LEXION combines. It allows automatic vertical response to changing terrain via an exclusive combine ground pressure sensor. This programmable cutting height feature helps to ensure that you automatically return to your set cutting position every time.

AUTO CONTOUR:
Faster and more accurate than ever.

Optional equipment for both combine and header, the CLAAS AUTO CONTOUR combines automatic vertical and lateral compensation for changing terrain and ground conditions. With advanced CLAAS ON DEMAND hydraulic and MACH 5 electrical technology, the AUTO CONTOUR system is the leader in terrain compensation performance.

The system records four pre-set cutting heights to ensure optimal performance in all crops and conditions, allowing you to focus on other harvesting tasks. AUTO CONTOUR simplifies harvest by reducing operator fatigue, especially with larger heads, and increases efficiency by maintaining a consistent crop height.



CLAAS Threshing & Separation

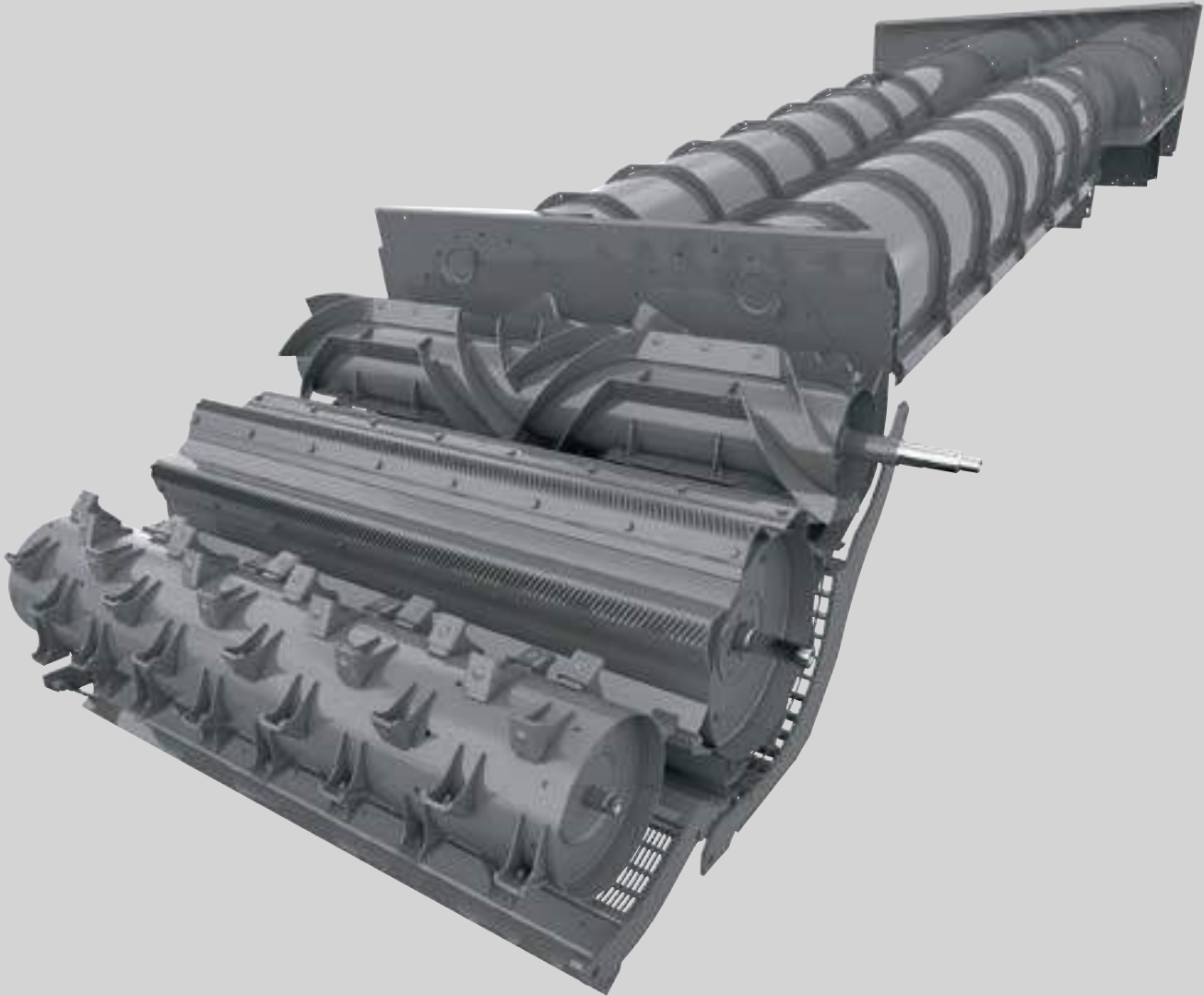

APS + ROTO PLUS

Only CLAAS integrates both systems into one combine to achieve what other combines cannot.

- Independent threshing and separation speed control
- More adaptable to changing crops and conditions
- Maintains greater throughput optimization

Models

780
760
750
740
730(P)
730

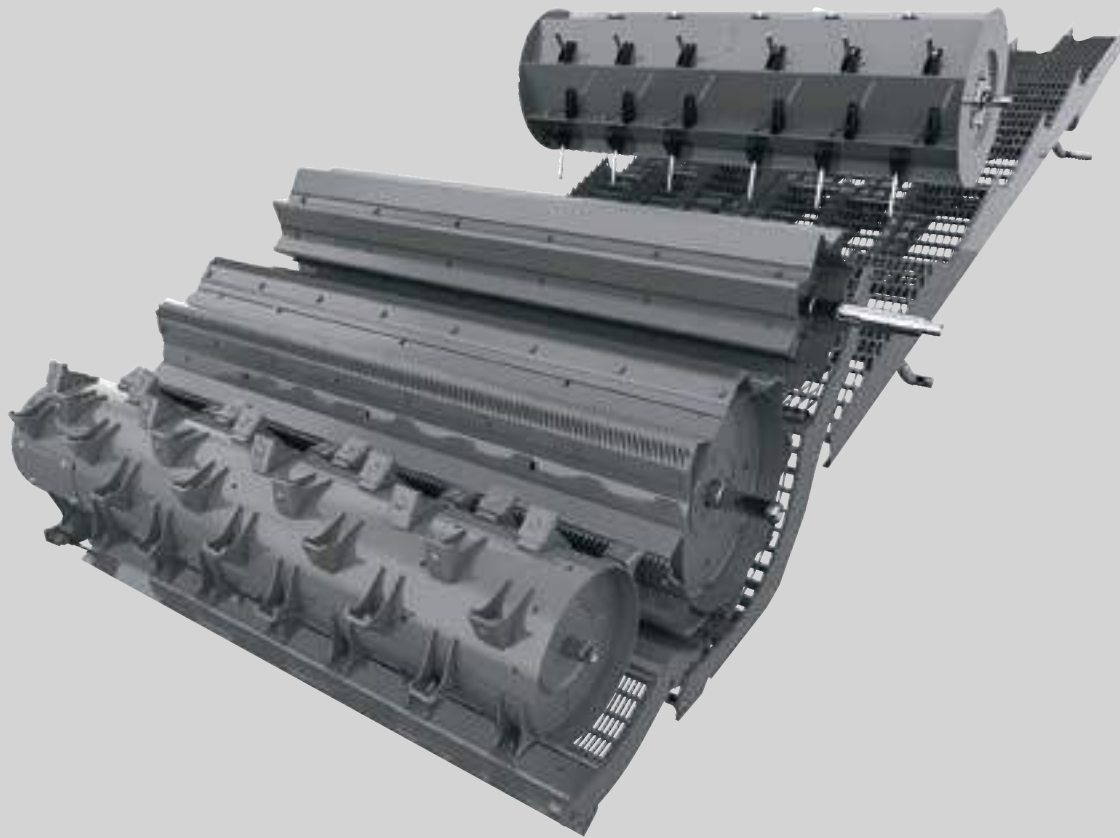

APS + Multi-Finger Separation System

The same leading threshing technology of the LEXION 700 Series is combined with advanced straw walker separation technology from CLAAS to provide the greatest separation performance possible without compromising straw quality.

- Extra-long straw walkers with the exclusive Multi-Finger Separation System drum provide unmatched straw walker separation.

Model
670

"The APS SYSTEM lets me get in the field earlier and stay out later, giving me the largest output per day during our limited harvest window."

APS threshing technology



APS: Separation starts up front.

The exclusive APS system is the heart of every LEXION combine, and is what gives all LEXION combines their in-field advantage.

- Up to 30% of all grain is pre-separated by the APS cylinder and concave (ahead of the threshing cylinder) to reduce the load on the main concave for more effective and thorough threshing performance.
- During pre-separation, the APS cylinder optimizes crop flow by accelerating the crop and distributing it evenly over the full width of the threshing cylinder. The distributed material enters the threshing cylinder at the same speed, width, thickness and angle for maximum threshing efficiency
- Reduces wear and tear on the combine
- More efficient use of power for greater fuel economy

Rasp bar threshing drum.

The APS threshing cylinder features a completely enclosed drum with raised rasp bars (24 inch tip diameter) to provide solid threshing in all conditions. The raised rasp bars allow greater expansion of the crop between them to enhance performance without compromising efficiency. All rasp bars are constructed using extremely durable material for extended wear life.

Several different APS grate options are available.

Up-time is critical to getting maximum productivity from your combine, so spending an hour or more reconfiguring concaves to achieve quality threshing performance can significantly reduce productivity. In a LEXION, the only grates to change between crops are easily accessible from the rock trap. These APS concave grates are located under the APS cylinder, which can be changed easily and quickly (as needed).

Impeller

Threshing drum

Accelerator (APS)



APS provides good results faster.

Synchronized concave adjustment with overload protection.

Our exclusive hydro-mechanical concave adjustment ensures precision finger-tip adjustment when fine-tuning performance. Hydraulic cylinders attached to the mechanical adjustment linkages on each side of the concave adjust the pre-concave and main concave simultaneously. Each concave moves in and out from its respective cylinder to prevent any bottle neck in the crop flow. This exclusive movement reduces wear and tear on the crop and the elements of the threshing system.

If a foreign object or extremely dense slug of material is ingested into the concave area, the hydro-mechanical adjustment linkage is equipped with a relief valve that will automatically drop the concave open (and reset automatically) to help avoid damage to the system and make clean-out easier.

Dis-awning plates.

Dis-awning plates are an exclusive lever-operated blanking plate system under the APS grates that can be used to enhance threshing performance. Because they are lever operated, the operator can engage or dis-engage them in seconds without tools and without having to access the inside of the machine.

Synchronized threshing speeds.

To maintain consistent material flow, each change made to the speed of the threshing cylinder will simultaneously change the speed of the APS cylinder and rear impeller. This maximizes efficiency while at the same time protects the crop.

ROTO PLUS. A superior concept.

Further ahead of the others.

Two counter-rotating 17.5 inch diameter rotors generate more separation force, more efficiently than combines with a single-rotor processor. When you combine that force with their near 14 ft. length, you end up with the industry's highest capacity separation system – per class.

Take advantage of the unbeatable combination of APS + ROTO PLUS.



Rotor covers shown in closed position.



ROTO PLUS separation.

ROTO PLUS separation is a simple process. The rear impeller of the APS System divides the crop into two smaller, more manageable swaths and feeds them into the rotors.

The ROTO PLUS system is made up of twin elliptical tubes that are each fitted with a 17.5 in (445 mm) diameter by 13.75 ft long multi-crop paddle rotor, anchored just below the center of the tube - which is ideal placement for optimizing separation performance.

Adjustable rotor covers.

All 700 series combines can be equipped with the hydraulic rotor cover plate option. The purpose of rotor cover plates is to hold material longer within each rotor cage to improve separation performance (as needed). The covers are fitted on the outside of the front two rotor grates of each rotor to maintain consistent crop flow without any drag on power.

Rotor Cover Positions:

1. All grates open
2. First set of grates closed
3. First and second grates closed
4. Third and fourth grates closed
(780 Small Grains combines only)

Variable rotor speed adjustment.

Rotor speed adjustments are made easily using the CEBIS dial. Separation speed can be adjusted independently of the threshing system from 400 to 1000 rpm to provide more efficient and practical adjustments on the go as field and conditions change.





JET STREAM.

The JET STREAM cleaning system is specially designed to handle the leading throughput of the APS Hybrid system.

- Removable poly preparation floor segments
- Dual-step cascade pre-cleaner with exclusive JET STREAM
- Large sieves (6 ft long top sieve and 5 ft long bottom sieve)
- Eight turbine fans (LEXION 780/760)
- Six turbine fans (LEXION 750/740/730)
- GRAINMETER

Cascade pre-cleaner.

The dual ventilated cascade step ensures intensive pre-cleaning. An extra wind tunnel from the turbine fans directly supplies this area an intense stream of air over the full width of the pre-cleaner enabling the lighter chaff to be blown free of the grain.



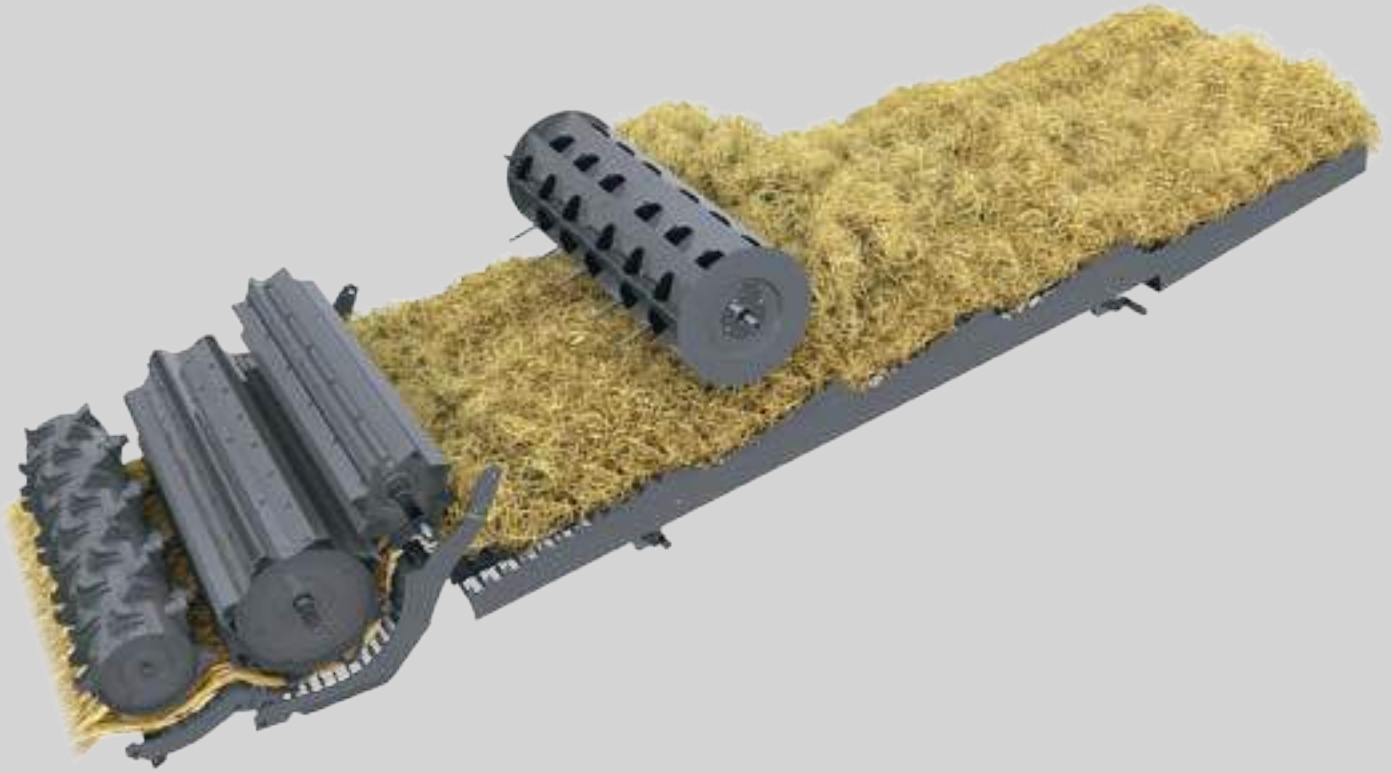

Get it all. Straw walker separation.

The APS threshing system on all LEXION combines works so efficiently that most of the grain is separated out during the pre-separation and threshing process. This efficiency means there is less grain that needs to be separated from the straw by a machine separation system.

Straw walker separation of the class 7 LEXION 670 is enhanced by the Multi-Finger Separation System (MSS) for extremely effective separation action while maintaining high-quality balable straw.

Each walker is 14.4 ft (4400 m) long and comprised of four aggressive steps fitted with fish-back risers for more aggressive separation action. Large perforations allow grain to be shaken through the walkers onto a pan beneath that delivers the material to the cascade pre-cleaner.



Thorough agitation of the crop mat is critical for high separation efficiency, particularly under difficult field conditions such as wet straw or green straw. The LEXION 670 is equipped with the Multi-Finger Separation System (MSS) to ensure effective residual grain separation under all conditions.

Effective straw walker technology.



Multi-Finger Separation System (MSS) increases output.

MSS actively fluffs the crop with multiple controlled tines which dig into the straw. The tines reach into the mat of straw from above and aerate it while simultaneously speeding it up. The straw mat is thinned, making it easier for the remaining grains to separate out. The available length of the straw walkers is used more effectively, while the structure and quality of the straw is optimized. The operation speed of the tines can be adapted to changing harvest conditions.

Fast and easy tine adjustment makes fine-tuning your LEXION 670 combine's walker performance a breeze.

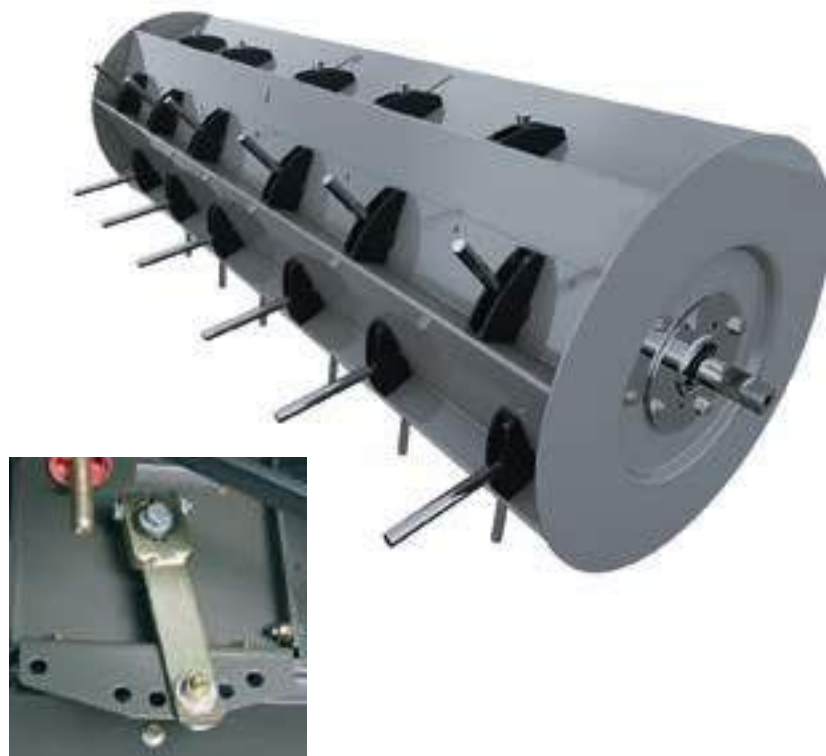

Standard cleaning system (LEXION 670 only).

The standard cleaning system is tuned specifically for use with straw walker separation, maintaining balanced airflow and efficient cleaning. Extra-long sieves are controlled electrically from the cab.





Preparation pan.

Located below the APS System, the preparation pan starts the cleaning process using its exclusive shaking action to stratify the heavier grain to the bottom and the lighter chaff to the top. Using this method to transfer grain to the sieves eliminates the need for shoe augers that not only complicate the cleaning process by keeping the grain and chaff mixed together but can result in added damage to the crop caused by the augers. Once material travels to the end of the preparation pans, the material flows over the dual ventilated cascade step allowing the chaff to be blown out of the sieve area. This decreases the work load on the sieves, allowing for increased cleaning capacity.



In-cab visual returns monitoring.

Clean work for brilliant results.

3-D cleaning system.

- Dynamic slope compensation actively controls the pitch of the top sieve
- Operating range up to 20% side slope
- Maintenance free with no additional moving parts
- Fast, simple retrofitting
- Together with the AUTO CONTOUR, it is the ideal “hillside package”

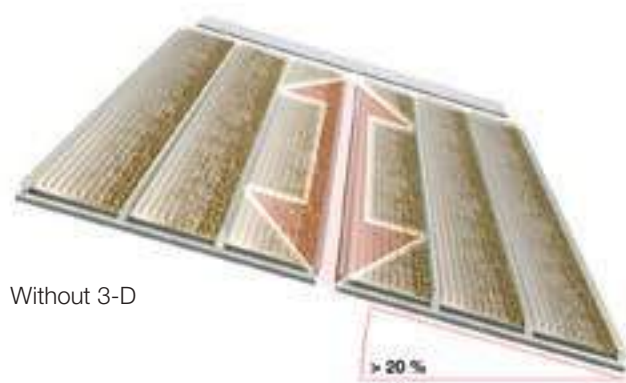

Without 3-D

Returns window.

Actually seeing what is in the returns elevator allows the operator to make smarter settings adjustments for improved performance. All LEXION combines allow the operator to look directly into the returns cross auger through the exclusive returns window located in the lower right hand rear corner of the cab.

All LEXION models also have the option to be equipped with the electronic returns monitoring system with a digital read out displayed on the CEBIS monitor.

GRAINMETER (optional).

And, for those who prefer the ultimate in returns monitoring, the exclusive GRAINMETER displays on CEBIS the amount of grain being carried within the volume of returns.

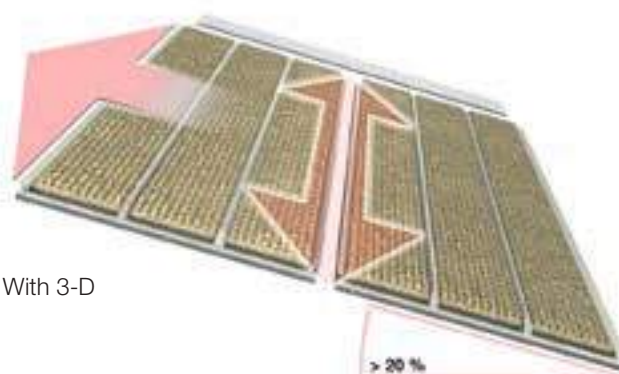

With 3-D

Up to 385 bushels of the highest quality grain.

Power folding grain tank extensions.

Introduced as an industry-first and standard on all LEXION combines are the power folding grain tank extensions. The operator simply pushes a button inside the cab for fast, reliable hydraulics to open and close the grain tank extensions without having to enter the grain tank.

Fast unloading.

The high performance, robust auger system delivers up to 3.8 bushels of grain per second unloading rate (3.2 bu/sec for LEXION 670, 2.8 bu/sec for rice combines). Four unloading auger lengths (24.2 ft., 26.2 ft., 28.2 ft., and 29.2 ft.) are available to ensure extra clearance needed for large heads.

Heavy-duty grain tank.

The heavy-duty grain tank was further improved, now featuring extended-wear grain tank floor, auger troughs, augers, and vertical unloading tube and housing.





4XL Unloading auger.

An even longer unloading auger is now available on the LEXION combine line. The new 4 XL unloading tube reaches out 29.2 ft. from the center of the combine, which is perfect for harvesting with heads over 40 ft wide.



LEXION 670 with up to 330 bu grain tank capacity and 4XL unloading auger.

The LEXION 670 straw walker combine has an increased grain tank volume of 300 bu standard and an optional capacity of 330 bu, and is available with an unloading rate of 3.3 bu/sec and the new 4XL (29.2 ft) unloading auger.





After harvest is before harvest.

As yields increase, the amount of residue (straw and chaff) to manage also increases. How the residue exits is just as important as how it enters. Rapid, complete residue decomposition will improve next year's planting season and yields. Residue chopped to a uniformly short length and spread evenly across the full width of the field is a decisive factor in next year's success. Several different residue management solutions are available.

MAV® (Maximum Air Velocity) Chopper.

The MAV system features 60 knives paired over the rotating drum with 31 stationary knives that can be engaged/ disengaged according to crop type. The MAV drum also includes 6 winged fan blades on both ends to pressurize the MOG for an accelerated exit velocity and assure a uniform spreading width of up to 35 ft.



Ready for the next harvest with CLAAS residue management.



1. Spreading rotor
2. Paddle
3. Material flow
4. Outer deflector
5. Inner deflector

TURBO Chop.

Another option for small grains consists of up to 88 closely arranged dual-blade knives spinning at up to 3450 rpm along with a bank of up to 62 counter knives to create finely chopped residue. Off the sieve, chaff is collected by the chaff spreader mounted directly behind the shoe. Chopped straw is distributed and blown into stubble via the adjustable active spreader. With one bolt, the tail board can be pitched up or down allowing the operator to adjust the residue spread pattern.

PRO Chop.

The premium small grains chopper option consists of up to 108 closely arranged dual bladed knives spinning at a speed of up to 3450 rpm. A bank of up to 62 counter knives creates the recipe for extremely fine chopped residue. The chaff from the sieve is combined with the chopped straw before it is evenly distributed by the powered counter-directional discharge distribution rotors.

With two pivoting discharge arms that swivel in front of the powered distribution rotors that direct the material, the LEXION has the ability to ensure a perfect and top-quality residue spread across the entire working width. From within the cab via the HOTKEY an operator has the ability to set the spreading width, spread direction, compensation for side wind, and the percentage of center overlap.

All new side wind compensation: The PRO CHOP system now also includes a side wind sensor that will actively adjust the spread pattern according to side hill and side wind.



Premium working conditions.

CLAAS takes cab comfort and functionality seriously. With excellent soundproofing to keep noise to a minimum, a multi-adjustable steering column, and easy to reach instruments, levers, and pedals, the cab makes any operator feel at home. Add to that a climate control system and sun shades, and you're ready to take on any time of day or year.

Cushions, supports, ventilates and keeps you comfortable: The deluxe leather operator's seat.

The deluxe operator's seat (standard on all corn and small grain model LEXION combines) adds an extra level of comfort for the operator. Able to heat or ventilate, it's comfortable enough to sit in all day long.

Standard: Trainer seat with integrated cooler.

- Integrated left arm support on the door
- Backrest folds down into desk/work station
- Larger 45 qt (43 l) cooler with integrated cupholder
- Ample storage space



More space, comfort and operator performance.

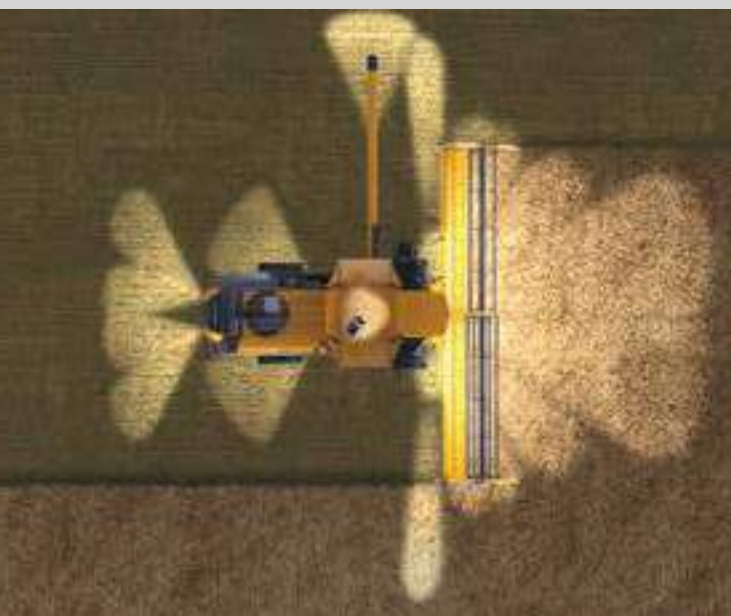

Turn night into day.

Powerful H9 halogen and xenon lights ensure the best visibility for the field and machine components - even at night. Intelligent features such as the programmable overhead light panel make for a customizable package.

- Up to 14 forward and 6 rear working lights total
- Up to 6 xenon forward cab lights
- Side lights, stubble lights, steering axle lights
- Automatic lighting of the unloading auger
- Automatic reverse lights
- Lighting for the cleaning system, grain tank and returns
- Service lights below the side doors
- Portable work light
- All working lights can be turned on during road transport



The overhead light panel allows the operator to select exactly the lights needed. User defined lights can be programmed on CEBIS.



The steering column is adjustable in three positions.

EASY. More to rely on.

The name says it all.

The electronic expertise of CLAAS can be summarized in one word: EASY: Efficient Agriculture Systems, and it lives up to the name. Combine settings, steering systems, software solutions and more: EASY makes it all simple. These systems can be matched perfectly, enabling you to get the best performance from your combine and top results for your operation.



Go on. Go easy.

EASY

Efficient Agriculture
Systems by CLAAS.



“Our machines have multiple drivers with different skills. We expect these machines to perform at an optimum level.”

EASY
Efficient Agriculture Systems
by CLAAS



Operator focused.

The CEBIS display - CLAAS Electronic on-Board Information System - allows total machine monitoring and control through its clear, intuitive menu structure.

The 8.4 inch color screen is movable and adjustable to reduce operator strain, and a Compact Flash drive makes pulling data for reports quick and easy.

CEBIS control panel.

The control panel has everything that you need to make machine adjustments within arm's reach. The CEBIS rotary dial controls basic machine adjustments while the HOTKEY rotary dial controls key functions.

Discover the benefits of simple push-button control with CEBIS. You'll find a demo version online at www.claas.com.

Multi-Function Handle – Standard.

Multi-Function Handle comes as standard on all LEXION combines. Integrated into the armrest, the Multi-Function Handle allows you to control multiple combine functions at the same time with two fingers, as well as your direction of travel.

The trigger switch on the back of the Multi-Function Handle enables VARIO fore/aft, MAXFLEX cutterbar, lateral tilt, MAXFLO draper reverser.

Multi-Function Handle – C-MOTION.

The new, optional ergonomically designed C-MOTION handle offers the same machine control commands as the Multi-Function Handle with improved comfort to reduce operator strain. Controls for combine functions are logically laid out so you can manage multiple functions at the same time with three fingers.



Everything under control. The new CEBIS.

PROFI CAM.

The optional factory-installed camera system located on the unloading auger allows you to view 3 operations from one camera position:

- Monitor unloading status
- Monitor chopper/ spreader performance
- Monitor rear view while in transport position

The PROFIL CAM system has ability to view 4 camera images at the same time by ordering additional cameras from CLAAS Parts.

BACKUP CAM.

The BACKUP CAM automatically shows up on the CEBIS screen when either the Multi-Function or C-MOTION handle is in the reverse mode, adding extra visibility over and above rear view mirrors when reversing. The BACKUP CAM is positioned on top of the rear shield for maximum viewing range and minimum dust exposure.



A world first: CEMOS AUTOMATIC

CEMOS DIALOG.

The CLAAS Electronic Machine Optimization System DIALOG (CEMOS DIALOG) puts the advice of a combine expert directly in the cab with you for the right combine settings every time, balancing power, quality, safety and efficiency. It optimizes all elements of the combine by guiding the operator to the optimal machine settings. The operator can actively seek guidance from CEMOS and accept or reject the suggestions.



CEMOS AUTOMATIC.

A further development of CEMOS. CLAAS has revolutionized the adjustment of machine settings on the LEXION. The new CEMOS AUTOMATIC system uses numerous sensors to monitor a very wide range of machine parameters second by second, immediately adjusting the separation and cleaning function settings to changing conditions. The reaction time and accuracy cannot be matched by even the most experienced operator. The rotor speed, rotor cover position, fan speed and the opening of the upper and lower sieves are controlled autonomously by CEMOS AUTOMATIC. The automatic adjustments are based on which harvest strategy you specify. These four strategies are:

- Maximum throughput (for tight harvesting windows)
- Minimum fuel consumption (for efficiency)
- High threshing quality (for the best grain results)
- Balanced (combines the other three strategies)

With CEMOS AUTOMATIC, the newest or most seasoned operator can make the LEXION perform optimally without fear of making mistakes during day-to-day harvest.

Currently, CEMOS AUTOMATIC supports wheat, barley, canola, and oats. CLAAS is in the process of including more crops in the future.



- ← CEMOS AUTO SEPARATION
- ← CEMOS AUTO CLEANING
- ← CRUISE PILOT

Utilize the full potential.

CRUISE PILOT: Automatic forward control.

Now available on all 600 and 700 Series LEXION combines, the CLAAS CRUISE PILOT system automatically adjusts your LEXION combine's ground speed to your crop conditions. By anticipating peak loads before they occur, you are able to maximize output and efficiency.

The multi parameter intuitive system of CRUISE PILOT takes into account the following conditions:

- Ground speed
- Crop volume in feederhouse
- Engine load
- Grain loss

User defined preferences can also be programmed into the system, such as:

- Constant speed
- Constant throughput
- Constant throughput with losses

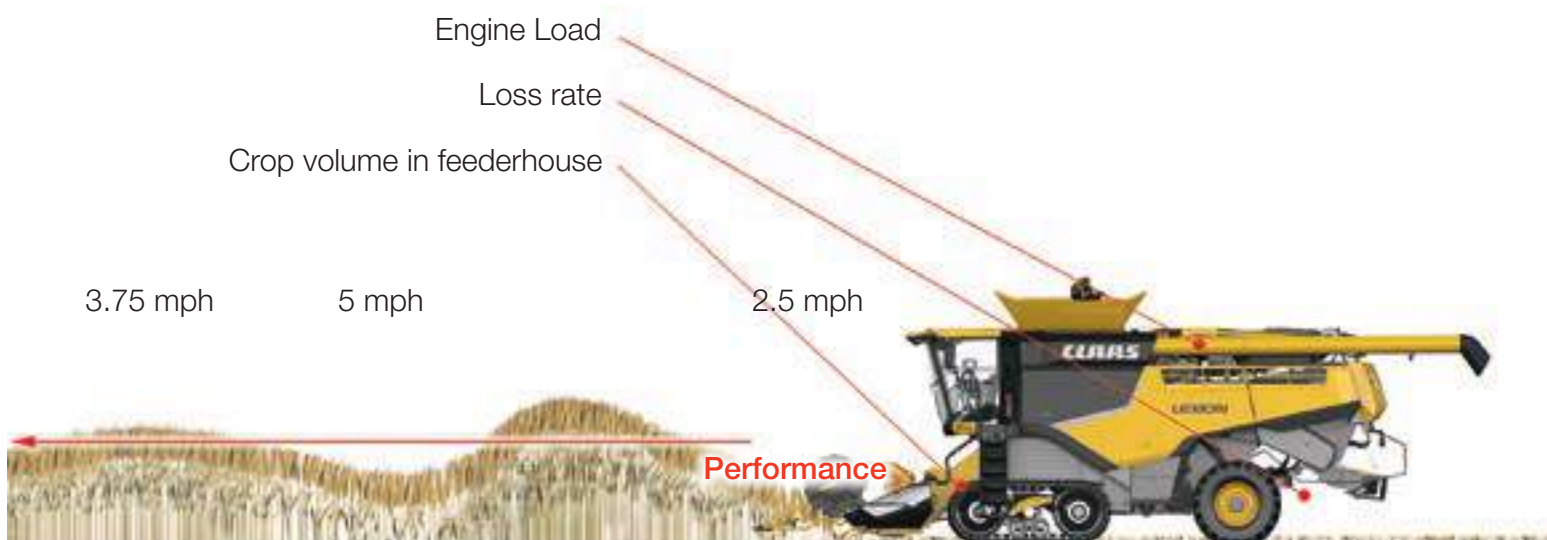



Precision Farming.

The industry exclusive CLAAS CANBUS interface gives operators more flexibility of choice - allowing non-CLAAS products to talk to CLAAS machines. All QUANTIMETER outputs for yield and moisture are sent to the ISOBUS terminal for Non-CLAAS monitor display. When GPS steering is used all inputs are sent through the CLAAS CANBUS from the Non-CLAAS steering systems to utilize the CLAAS integrated steering valve.

CEBIS

- Integrated CLAAS solution
- All field data stored in CEBIS for downloading

Ag Leader

- Factory installed option
- Yield mapping capability
- Machine steering capability

Trimble

- Dealer installed option
- Yield mapping capability
- Machine steering capability

Additional interface solutions

- Dealer installed option
- Yield mapping capability
- Machine steering capability

QUANTIMETER.

The QUANTIMETER monitoring system measures combine performance and yield. The system is easily calibrated and continuously measures grain moisture content and outputs the data to CEBIS or other installed precision monitoring displays.

The QUANTIMETER uses a volumetric measuring system that measures material in the clean grain elevator. An LEM sensor measures material on individual paddles, and even provides accurate readings on sloping terrain by implementing lateral and transverse tilt corrections and accounting for engine load speed.

Hydraulic chain tensioning for clean grain elevator is standard on all LEXION combines equipped with QUANTIMETER.





Automatic steering systems to meet the growing demands for precision farming.

Monitoring yield data supplemented by the grain moisture reading generates a complete report about harvested grain. All information gathered from the QUANTIMETER is displayed on the CEBIS terminal from the harvest display screen, or if outfitted, on the Ag Leader Integra or Trimble FmX monitor immediately to understand how the crop is performing.

Yield maps can be viewed on integrated monitors in the cab during harvest for instant analysis of fields and conditions. Automatic controlled steering via GPS satellite signal guides the machine precisely and effortlessly on line so the operator can focus on maximizing the performance of the LEXION.

The open architecture offered by CLAAS gives the grower the freedom of choice as to which precision farming guidance solution is the best fit for their operation.

Ag Leader®.

Ag Leader's precision innovations in agriculture technologies are designed to give you maximum performance to match that of a LEXION. The new GeoSteer antenna boasts Flex Mode. With Flex Mode - even when your signal is temporarily lost - by automatically transitioning to a differential signal, accurate steering is maintained. When the better signal is restored, the system will transition back to the higher accuracy mode.



In line. Down to the inch.

Trimble® compatible.

The CLAAS open architecture structure via the CLAAS CANBUS allows Trimble Guidance, Steering and Yield Monitoring components to connect to the LEXION combine (Trimble base vehicle kit needs to be installed by your local dealer). The FmX® offers a full-featured display for your harvesting needs.

LASER PILOT.

Optical sensors of the LASER PILOT use pulses of light to scan the edge between the crop and stubble, guiding the LEXION automatically along the crop border.

When not in use, LASER PILOT can be pivoted into a safe transport position. Being mounted on the header gives the LASER PILOT optimal positioning ensuring high functional reliability on gradual corners or slopes.



CLAAS TELEMATICS



Monitoring.

Optimize the performance of the machines remotely by observing functions that make it possible for you to carry out direct oversight or comparisons between the settings and performance data of up to three machines online when you can't be everywhere at once. Gain reassurance that your operators are making use of the full potential of the machine at all times.

Tracking.

Keep track of what is happening with your machines and personnel resources in your fields. Using Google Earth, you can load the track lines against the aerial maps to monitor idle time, working positions, and loading/unloading. For larger farms, the ability to identify any logistical or organizational issues is important to maximize the work that gets done per acre.

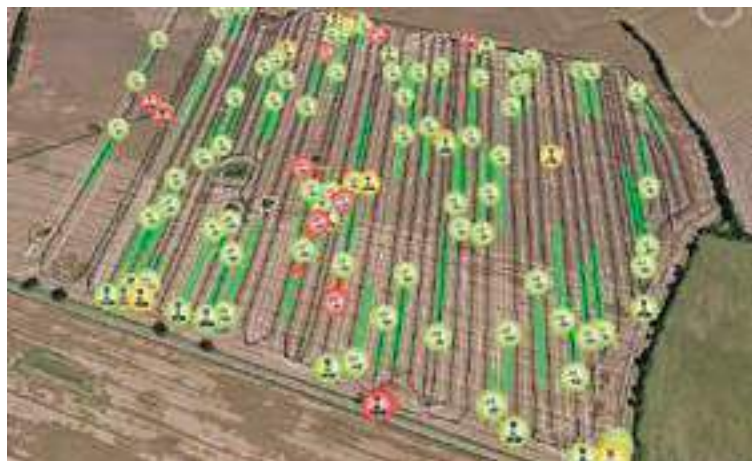



Analysis and statistics.

Operating time analysis.

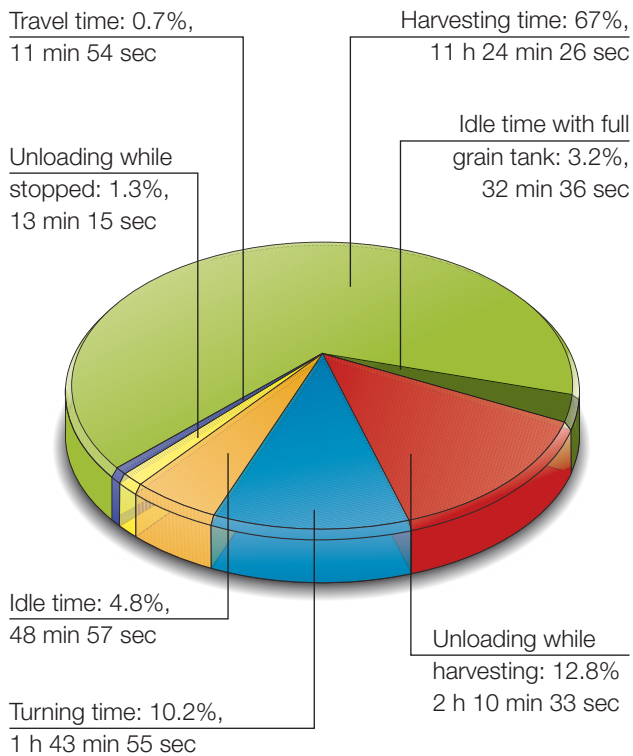

Simplified documentation.

With TELEMATICS, you can export data from the fields you have harvested and analyze:

- Yield maps
- Moisture maps
- Loss maps

APDI is an acronym standing for Automatic Process Data Interpretation and allows TELEMATICS to fully autonomously collect and create data, maps and reports. The machine operator has no need to select fields, farms or operation related information anymore, TELEMATICS will recognize if a machines pulls into a field, and automatically start the data collection.

APDI allows all data for each individual field to be automatically saved in TELEMATICS for easy downloading. Via a secure CLAAS server, data is interpreted and evaluated based on field borders imported from your farm management software. APDI generates posting records in a compatible format for farm management systems so information can be used for automated invoicing on custom jobs.



Field and yield management.

All data is backed up at the end of each specific task or field, or at the end of each workday. In addition to displaying daily counts, crop counts, and total counts in CEBIS, the field data can be printed out in the combine (using an optional printer).



Information management.

Software solutions.

CLAAS offers intelligent software solutions through either Ag Leader SMS or Farm Works Software® – a division of Trimble – to support you in your operation on the farm.

Ag Leader SMS.

SMS™ is a powerful desktop software that helps you to take your data from your field and turn that information into smart management decisions, using data gathered from planting through harvest.

Trimble Farm Works Software.

Farm Works™ Mapping software provides a mapping and field record keeping solution that equips you to make better choices for your operation using yield data to identify areas that deliver consistently high or low yields.

SMS basic computer screen



Trimble Farm Works Software



CLAAS POWER SYSTEMS (CPS).

Optimal drive for best results.

With CLAAS POWER SYSTEMS (CPS), we have brought together the best components in a drive system putting them in a class of their own. One that always delivers the greatest power when needed. Ideally matched to the systems and with fuel-saving technology that quickly pays for itself.

This comes from 15 years of development experience on the LEXION alone. The result is the best drive system ever from CLAAS, one that gives the greatest efficiencies.





"Spaced out fields, steep slopes and inclines – that shouldn't keep me from bringing in a good crop."

CLAAS POWER SYSTEMS



Modern high-performance engines.

Get both high power and low fuel consumption with the CLAAS POWER SYSTEMS selection of engines from Caterpillar & Mercedes-Benz.

All CLAAS combine engines meet current government emission standards, along with offering lower engine speeds increases fuel savings.

The Mercedes-Benz engines are Tier 4 final compliant with solenoid – valve controlled single injection pumps.

The Caterpillar engines have Mechanical Electronic Unit Injection (MEUI-C) on the C13 engines.

Larger fuel tank.

Up to 304 gallons (1,150 L) of fuel tank capacity is standard on LEXION 780 and 760, optional for LEXION 750, 740, and 730.

New: increased engine output with reduced fuel consumption (LEXION 670).

Beginning with model year 2015, the LEXION 670 will feature a Mercedes-Benz 10.7 liter Tier 4 final engine and build on CLAAS POWER SYSTEMS (CPS) technology to deliver optimal power transfer at one of the lowest fuel consumption rates in the industry.



More power in reserve.
The engines.



	Manufacturer	Model	Cylinders / displacement	Engine capacity at 1900 rpm
LEXION 780	Mercedes-Benz	OM 473	Inline 6 / 15.6	540 (405)
LEXION 760	CAT®	C13	Inline 6 / 12.5	503 (375)
LEXION 750	CAT®	C13	Inline 6 / 12.5	456 (340)
LEXION 740	CAT®	C13	Inline 6 / 12.5	402 (300)
LEXION 730 (P)	Mercedes-Benz	OM 470	Inline 6 / 10.7	348 (260)
LEXION 730	Mercedes-Benz	OM 470	Inline 6 / 10.7	320 (239)
LEXION 670	Mercedes-Benz	OM 470	Inline 6 / 10.7	375 (280)



New: DYNAMIC COOLING.

The new cooling system from CLAAS comes standard on all LEXION combines. A large 63 inch diameter rotating screen shields a variable speed cooling fan that runs as needed at varying speeds based on cooling needs. This fuel saving feature conserves power for greater machine efficiency.

The DYNAMIC COOLING system creates a curtain of air around the machine by pulling the clean air from above and forcing it around the machine. This air then pushes the dust and debris away from the machine.

- Time between service intervals increases because cleaner air flow through radiators reduce need to blow out the system.
- Material from rotary screen is sucked off and blown below.
- Engine air filter draws in cleaner air.



More than a first-class combine.

The LEXION name stands for the ability to handle any challenge, to perform to the highest standards, and to deliver clear, measurable results that you can take to the bank. The LEXION embodies not only the experience gained over more than 75 years of combine production at CLAAS, but also valuable input from customers and an understanding of the challenges that the future holds.

More powerful, more productive, more flexible, more comfortable, more profitable: the new LEXION 670 stands for all these qualities and represents a combine class in its own right.



The all new 2015 LEXION 670 not only features a brand new Tier 4 final compliant Mercedes-Benz OM 470 engine, but now is upgraded to the highly efficient DYNAMIC COOLING system. This will ensure the LEXION 670 leads the conventional combine segment in efficiency and performance.



Higher speeds? No problem! Get from field to field at 25 mph (40 km/h).

Every minute a combine is in the field rather than in transport improves performance. The LEXION 740 and 750 TERRA TRAC are the industry's first tracked combines with a road speed of 25 mph (40 km/h).

The industry leading technology of the TERRA TRAC enables the LEXION to get from field to field faster than any other combine – with the highest level of safety and driving comfort as well as outstanding track stability. TERRA TRAC facilitates longer harvesting days and significantly increases seasonal performance. Improved adaptation to ground contours, and lower machine stress with a integrated intelligent track system speaks for itself.

TERRA TRAC. More comfortable than ever before.

With TERRA TRAC, your LEXION gives you a smoother ride than ever before. Intelligent design makes this possible: An integrated front axle on the LEXION is designed and built just for the track unit. In the TERRA TRAC, all components (drive wheel, idler wheel, and bogie wheels) are fully independently suspended, reducing shocks to the operator and combine, therefore increasing driver comfort and providing greater stability on curves.

Automatic leveling.

- The hydropneumatic suspension can be raised or lowered during operation by the use of hydraulic cylinders.
- The drive wheel, idler wheel and bogie wheels are independently suspended; hydraulic cylinders with integrated accumulators provide the suspension.
- The result is automatic leveling for improved stability on curves.
- At 1.5 mph (2 km/h) the Generation III TERRA TRAC self leveling system engages automatically.



LEXION 740 TERRA TRAC and LEXION 750 TERRA TRAC – the fastest track combines in the world



World-class on the road, gentle on the field.



TERRA TRAC at a glance.

When you protect the soil during harvesting and prevent soil compaction, you won't have to worry about decreased crop yields next year.

- Transport width of just under 14 ft
- Soil protection: as low as 10.5 psi ground pressure
- Improved traction (rice/wet conditions/rolling terrain)
- Greater stability on slopes
- Less drive resistance, less slippage and lower fuel consumption
- 35 inch wide TERRA TRAC offers unmatched ground flotation performance



4-Link axle for exceptional maneuverability (780/760).

This industry first, developed and patented by CLAAS, sets new standards by ensuring unrestricted mobility with tires up to 30 in (1.65 m) in height. And it provides exceptional stability and load bearing capability.

Unlike a conventional pivoting axle that pivots from a center suspension point, the new 4-link axle is suspended at two points, and not only pivots up and down, it also shifts laterally for improved terrain compensation and ease in turning.

4-Link POWER TRAC (780/760).

CLAAS POWER TRAC provides greater traction thanks to the hydrostatic drive on the rear axle. With the ability to engage POWER TRAC while moving, this adjustable rear axle reduces fuel consumption due to greater efficiencies.

Ultimate control.



Center Link POWER TRAC (750/740/730).

With the same mobility as previous models, the center link POWER TRAC gives your LEXION greater traction from the hydrostatic drive on the rear axle. POWER TRAC can be engaged while moving, and the adjustable rear axle reduces fuel consumption due to greater efficiencies. Additionally, the system completely declutches during road transport to save even more fuel.

Larger rear tires.

Bigger rear tires mean a larger contact area with the ground, and a reduced tire track depth. For rear tire options, please refer to the chart on page 63.



The headers.

Automatic reel control.

Auto reel presets can be set to customize the reel's performance to the specific needs of the crop. The operator can set up to four auto reel speed and height pre-sets. Adjustment can be made on-the-go to fine-tune performance when needed.

Different working heights of the reel can be saved and recalled for various cutting heights, however the reel height can always be directly independently adjusted.

VARIO automation.

The VARIO header with automated reel control enables the reel leveling and table position to be saved and recalled by activating the automatic header control. Manual adjustments can also be made.

Automatic functions:

- CONTOUR / AUTO CONTOUR
- Automatic reel speed
- Automatic reel height
- Automatic reel leveling
- Automatic VARIO table positioning



Headers

"The combine must feed as efficiently as possible, so I need a header that meets these needs."



MAXFLO



MAXFLEX and Flex headers



VARIO headers



SWATH UP



Join the revolution.



MAXFLO. From CLAAS.

The MAXFLO is a revolution in draper head technology, providing optimal crop flow from a rigid platform header in all crop conditions without the need of a center feed belt.

With model year 2014, the MAXFLO headers received upgrades, including a larger, more powerful reel, an ungraded cutterbar design and foldable stabilization wheels for ease of transport.

The MAXFLO 900 and 750 rice headers also feature a specialized rice cutting and crop flow system, featuring a high torque reel with tight reel tine spacing and improved crop dividers and cutterbar setup.

Different from the usual systems.

CLAAS engineers have designed an innovative new intake system using an intake auger instead of the traditional center feed belt. Compression augers mounted laterally onto the intake auger provide a natural transition into the feederhouse.

This patented new flow design results in higher efficiency for greater machine performance and is ideal for small grains crop and rice.





How the technology works:

- Power is transferred to the synchronized knives via PTO shafts.
- No bulky additional adapter required.
- Feed drum speed can be adjusted to three settings (150, 200 and 250 rpm)
- The speed of the draper belts can be adjusted in CEBIS via the HOTKEY.
- The belts can be reversed from inside the cab.
- The unique form of the center-bearing supported reel prevents the crop from wrapping.

Header guidance with sensors.

On equipped combines and headers, six sensor bands are utilized for AUTO CONTOUR control and header guidance. Gauge wheels on the MAXFLO assist in maintaining header stability.





The MAXFLEX header: down-to-earth quality.

To prevent substantial losses while harvesting crops close to the ground, maximum flexibility is needed in a flex header.

MAXFLEX 1200 and MAXFLEX 1050 headers from CLAAS are equipped with a flexible cutting knife that automatically adjusts to changing ground conditions while reducing the potential for scooping up and ingesting foreign debris and rocks. The split reel, split auger, and dual knife design work together in conjunction with the HP feederhouse fore/aft adjustments to maximize header performance in all field conditions.

MAXFLEX headers are also capable of harvesting small grain crops because the MAXFLEX cutterbar can be locked into a rigid position. Hydraulic cylinders are used to adjust the cutter bar from flex to rigid from the cab, and locking bolts can be inserted into the table floor to secure the header in rigid mode. With the optional AUTO CONTOUR sensing bands installed in rigid mode, the MAXFLEX header is able to closely follow the ground contour even in tough terrain.

Automatic reel control.

Auto reel presets can be set to customize the reel's performance to the specific needs of the crop. The operator can set up to four auto reel speed and height pre-sets. Adjustment can be made on-the-go to fine-tune performance when needed.

Different working heights of the reel can be saved and recalled for various cutting heights, however the reel height can always be directly independently adjusted.

Automatic functions:

- CONTOUR / AUTO CONTOUR
- Automatic reel speed
- Automatic reel height
- Automatic reel leveling

Harvesting lentils and soybeans.
Fast and easy.





Consistent crop flow to enhance performance.

Using the VARIO head's exclusive fore/aft cutter-bar adjustment, you can maintain a more consistent crop flow to the APS threshing system by adjusting the depth of the cutterbar (on-the-go) to match the needs of the crop.

- Hydraulic operation
- Ensures a more consistent performance
- Smooths crop flow
- Protects drive from unnecessary slugs
- Side knife option for straight cutting canola

VARIO 1200 and VARIO 1050.

- Knife drive design with dual synchronized planetary drives offers drive overload protection
- Center supported reel with a four hydraulic lift cylinder system provide improved stability and reaction time
- Center supported intake auger bearing for improved stability
- Larger 26 inch (660 mm) diameter intake auger (on VARIO 1200) enhances crop flow and provides greater anti-wrapping protection, especially in tall crops like canola
- External adjustable stripper plates make fine-tuning the header fast and easy
- Hydraulically-driven side knives (optional) with on/off valve
- Adjustable stripper plates for fine tune feeding adjustment



VARIO: Better than ever.



Canola requires particular attention.

Ripe canola pods require careful handling while being harvested to prevent shatter loss. A rear grain catch pan and floor extensions are key components on VARIO headers.

With the VARIO, you have your choice of a 30 ft, 35 ft, or 40 ft cutting width.

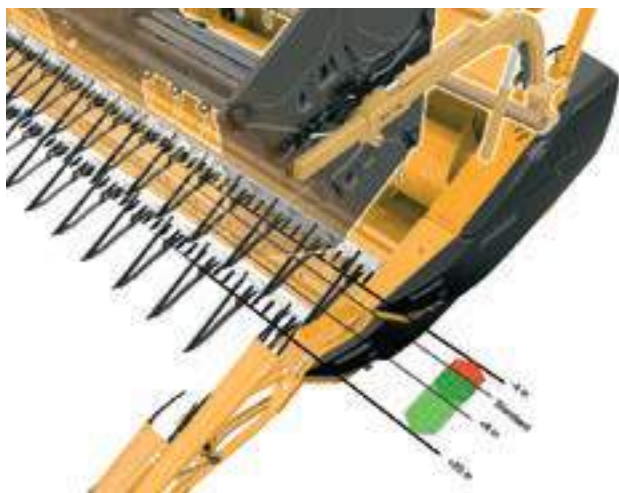

The right cut.

The cutterbar table can be extended forward by 8 inches (20 cm) or shortened by as much as 4 inches (10 cm) from the standard rigid head position to keep the crop flow steady and ensure efficient operation.

When harvesting canola, the cutterbar table can be moved forward an additional 20 inches (50 cm) by installing the extension plates.

Hydraulically driven vertical side knives (optional) are installed when straight cutting canola and attach easily via quick connects.



SWATH UP 450: The pick-up specialist.

When harvesting windrows, the SWATH UP 450 header is gentle on the crop while still delivering outstanding pick-up performance.

- Front belt rear roller middle support, the design greatly reduces belt slippage.
- Orbit motor on front belt for direct pull, with self-tightening V-belt drive of rear belt.
- Easy adjustable front wheel position with ultra float suspension for improved stability, reduced wheel bounce and reduced ground pressure.
- Draper roller mounting position reduces grain loss and back feeding.
- Hydraulically operated crop hold-down.
- CLAAS AUTO CONTOUR height sensors.

The perfect pick-up



At CLAAS, service isn't just a word.
It's a way of life.



Support around the clock.

Our spare parts warehouses in Columbus, Indiana and Regina, Saskatchewan deliver all ORIGINAL CLAAS parts quickly and reliably. No matter the size of your local dealership, CLAAS of America ensures parts will reach their destination fast, no matter where you are.

We speak the same language.

At CLAAS, we strive to be Your Harvesting Specialist, and we know what farmers want. By training our dealers with the knowledge and the most up-to-date diagnostic tools, we have a strong, knowledgeable LEXION support team ready to meet your demands for reliable service.

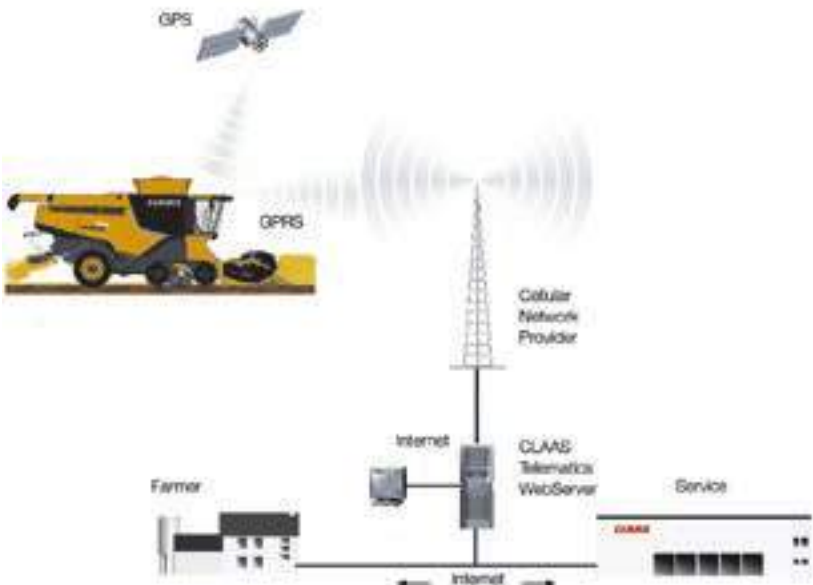

CDS Remote.

With CLAAS CDS remote diagnostics, help from your CLAAS dealer is much closer than you think. By granting "access rights", your dealer can conduct interactive remote diagnostics in real-time with your LEXION. If a service technician is needed on site, your dealership will have all the necessary information in advance and can send any spare parts required right away. Also, your dealer can monitor the combine's maintenance requirements allowing them to plan routine maintenance around your harvesting schedule.



Updated central lubrication system.

The central lubrication system from CLAAS supplies grease to practically all lubrication service points at a constant rate. Lubrication points and their service intervals are pre-programmed to deliver grease at an optimal rate. In contrast to manual lubrication, the grease is transported from the central reservoir and distributed to the lubrication service points while the machine is running to ensure effective grease application.

The new system integrates the TERRA TRAC system and offers a larger grease reservoir for longer intervals between refilling. Additionally, control of the central lubrication system is handled through CEBIS, keeping you in the know and your cab free from added monitors.



LEXION

		780 / 780TT	760 / 760TT	750 / 750TT	740 / 740TT	730 / 730P	670 / 670TT
Threshing System							
APS acceleration and pre-separation		●	●	●	●	●	●
MULTICROP concave		●	●	●	●	●	●
Drum width	in (mm)	67 (1,700)	67 (1,700)	56 (1,420)	56 (1,420)	56 (1,420)	67 (1,700)
Drum diameter	in (mm)	24 (600)	24 (600)	24 (600)	24 (600)	24 (600)	24 (600)
Drum speed	rpm	395 - 1,150	395 - 1,150	395 - 1,150	395 - 1,150	395 - 1,150	395 - 1,150
with reduction gear	rpm	166 - 483	166 - 483	166 - 483	166 - 483	166 - 483	166 - 483
18 concave		●	●	●	●	●	●
18 HD concave		○	○	○	○	○	—
Roundbar		○	○	○	○	○	○
Rice threshing unit (spike-tooth)		○	○	○	○	○	—
Concave wrap angle	degrees	142	142	142	142	142	142
Main concave area	in ² (m ²)	1,953 (1.26)	1,953 (1.26)	1,953 (1.26)	1,953 (1.26)	1,953 (1.26)	1,953 (1.26)
Total threshing area	in ² (m ²)	2,680 (1.73)	2,680 (1.73)	2,680 (1.73)	2,680 (1.73)	2,680 (1.73)	2,680 (1.73)
Electrohydraulic concave adjustment with overload protection		●	●	●	●	●	●
Synchronized accelerator and impeller		●	●	●	●	●	●
Automatic drum variator tensioning		●	●	●	●	●	●
Large stone trap		●	●	●	●	●	●
Separation							
ROTO PLUS high performance rotors	quantity	2	2	2	2	2	—
Rotor length	in (mm)	165 (4,200)	165 (4,200)	165 (4,200)	165 (4,200)	165 (4,200)	—
Rotor diameter	in (mm)	17.5 (445)	17.5 (445)	17.5 (445)	17.5 (445)	17.5 (445)	—
Rotor area	in ² (m ²)	5,735 (3.7)	5,735 (3.7)	5,735 (3.7)	5,735 (3.7)	5,735 (3.7)	—
3-Stage Rotor speed		○	○	○	○	—	—
In-Cab rotor cover adjustment		○	○	○	○	○	—
HD flax rotor		○	○	○	○	○	—
Straw walker separation	quantity	—	—	—	—	—	6
Walker length	in (mm)	—	—	—	—	—	173 (4.4)
Separation area	in ² (m ²)	—	—	—	—	—	15,268 (9.85) std
Multi-Finger Separation System		—	—	—	—	—	—
Total threshing & separation area	in ² (m ²)	8,412 (5.43)	8,412 (5.43)	6,886 (4.44)	6,886 (4.44)	6,886 (4.44)	17,948 (11.58)
Cleaning System							
JET STREAM cleaning system		●	●	●	●	●	—
Standard cleaning system		—	—	—	—	—	●
Plastic prep pan (divided, removable from the front)		●	●	●	●	●	●
Cleaning fans		8-turbine	8-turbine	6-turbine	6-turbine	6-turbine	6-turbine
In-cab speed adjustment		●	●	●	●	●	●
Dual ventilated step		●	●	●	●	●	●
3-D cleaning system		●	●	●	●	●	●
Less 3-D cleaning system		—	opt	opt	opt	—	—
Total sieve area	in ² (m ²)	9,610 (6.2)	9,610 (6.2)	7,905 (5.1)	7,905 (5.1)	7,905 (5.1)	8,990 (5.8)
In-cab sieve adjustment		●	●	●	●	●	●
Returns elevator (to APS)		●	●	●	●	●	●
Returns visible from cab		●	●	●	●	●	●
Electronic returns monitoring in CEBIS		●	●	●	●	●	●
GRAINMETER (includes electronic returns monitoring)		●	○	○	○	○	○
Grain Tank							
Volume	bu (l)	360 (12,600)	360 (12,600)	330 (11,629)	300 (10,572)	300 (10,572)	300 (10,572)
Optional high capacity grain tank	bu (l)	385 (13,500)*	—	—	330 (11,629)	330 (11,629)	330 (11,629)
Unloading auger swivel rate	degrees	101	101	101	101	101	101
Unloading rate	bu/s	3.8 (2.8 rice)	3.8 (2.8 rice)	3.8 (2.8 rice)	3.8 (2.8 rice)	3.8 (2.8 rice)	3.3 (2.8 rice)
QUANTIMETER yield monitor		●	●	●	●	●	●

* LEXION 780TT only

● Standard ○ Optional — Not available

© 2014 CLAAS of America Inc. LEXION is a registered trademark, and TERRA TRAC, JET STREAM, MAXFLO, CLEAN SWEEP, and MAXFLEX are trademarks of CLAAS KGaA mbH. CAT and Caterpillar are registered trademarks, and ACERT is a trademark of Caterpillar Inc. Ag Leader is a registered trademark of Ag Leader Technology. MAV is a registered trademark of Redekop Manufacturing Company. Trimble is a registered trademark of Trimble Navigation Limited. Capello is a registered trademark of Capello S.R.L. Swathmaster and Rake-Up are trademarks of MacDon Industries, Ltd. CLAAS continually develops its products to meet customer requirements. This means that all products are subject to change without notice. All descriptions and specifications in this brochure should be considered as approximate and may include optional equipment

LEXION

	780 / 780TT	760 / 760TT	750 / 750TT	740 / 740TT	730 / 730P	670 / 670TT
Residue management						
PRO CHOP 108 blade straw chopper	○	○	–	–	–	○
PRO CHOP 72 blade straw chopper	–	–	○	○	○	–
Automatic side wind adjustment	○	○	○	○	○	○
TURBO CHOP 88 blade straw chopper	●	○	–	–	–	○
TURBO CHOP 72 blade straw chopper	–	–	○	○	○	–
SPECIAL CUT 64 blade straw chopper	–	–	–	–	–	●
MAV® chopper 60 blade straw chopper	–	●	–	–	–	–
MAV® chopper 52 blade straw chopper	–	–	●	●	●	–
Straw spreader	○	○	○	○	○	○
High performance chaff spreader	●	●	●	●	●	●
Undercarriage						
TERRA TRAC with full suspension	● (TERRA TRAC)	● (TERRA TRAC)	● (TERRA TRAC)	● (TERRA TRAC)	–	● (TERRA TRAC)
POWER TRAC all wheel drive	○	○	○	○	○	○
2-gear transmission with electronic control	●	●	● (TERRA TRAC)	● (TERRA TRAC)	–	–
3-gear transmission with electronic control	–	–	●	●	●	●
Ground speed						
25mph road	–	–	● (TERRA TRAC)	● (TERRA TRAC)	–	–
19mph road	●	●	●	●	●	●
Overdrive (reduce engine rpm)	●	●	●	●	●	●
Engine						
Manufacturer	Mercedes-Benz	CAT®	CAT®	CAT®	Mercedes-Benz	Mercedes-Benz
Model	OM 473	C13	C13	C13	OM 470	OM 470
EPA certification	Tier 4 final	Tier 4 final	Tier 4 final	Tier 4 final	Tier 4 final	Tier 4 final
Cylinders / displacement	(l) Inline 6 / 15.6	Inline 6 / 12.5	Inline 6 / 12.5	Inline 6 / 12.5	Inline 6 / 10.7	Inline 6 / 10.7
Rated speed	rpm 1900	1900	1900	1900	1900	1900
Engine capacity at rated speed (SAE)	hp (kW) 540 (405)	503 (375)	456 (340)	402 (300)	"730P: 348 (260) 730: 320 (239)"	375 (280)
Maximum power (SAE)	hp (kW) 576 (430)	543 (405)	496 (370)	436 (325)	"730P: 375 (280) 730: 354 (264)"	402 (300)
Fuel consumption monitoring	●	●	●	●	●	●
Fuel tank capacity	304 (1,150)	304 (1,150)	210 (800)	210 (800)	210 (800)	210 (800)
Opt. fuel tank capacity (total)	●	●	○304 (1,150)	○304 (1,150)	○304 (1,150)	–
DEF tank capacity	gal (l) 22.5 (85)	22.5 (85)	22.5 (85)	22.5 (85)	22.5 (85)	22.5 (85)
DYNAMIC COOLING	●	●	●	●	●	●
EASY						
CEBIS	●	●	●	●	●	●
TELEMATICS	●	○	○	○	○	●
REMOTE SERVICE	●	○	○	○	○	●
Yield Mapping						
CLAAS CEBIS	○	○	○	○	○	○
Ag Leader® ready	○	○	○	○	○	○
Ag Leader® ex factory	○	○	○	○	○	○
Trimble® compatible	○	○	○	○	○	○
CEMOS	○	○	○	○	○	–
CRUISE PILOT	●	●	●	●	●	●
Automatic Steering						
CLAAS AUTOPILOT	●	●	●	●	●	●
Ag Leader® ready	○	○	○	○	○	○
Ag Leader® ex factory	○	○	○	○	○	○
Trimble® compatible	○	○	○	○	○	○
AUTO PILOT (corn rows)	○	○	○	○	○	○

that is not part of the standard specifications. Please refer to your nearest LEXION dealer and their price list for local specification details. Some protective panels may have been removed for photographic purposes in order to present the function clearly. To avoid any risk of danger, never remove these protective panels yourself. In this respect, please refer to the relevant instructions in the operator's manual. The annual AE50 award program is conducted and judged by the American Society of Agricultural and Biological Engineers (ASABE). Printed for distribution in the U.S.A. and Canada.

Heads

Flex Heads

		MAXFLEX 1200	MAXFLEX 1050	F900	F750
Effective cutting width	ft (m)	40 ft (11.97)	35 ft (10.44)	30 ft (9.14)	25 ft (7.62)
Cutting system					
Double knife		●	●	—	—
Single knife		—	—	●	●
Knife drive		synchronized transmission drive on both sides	synchronized transmission drive on both sides	gearbox and over-load protection	gearbox and over-load protection
Spare knife		2 ●	2 ●	1 ●	1 ●
Folding divider		—	—	●	●
Vertical flex range	in (mm)	7 (178)	7 (178)	4 (102)	4 (102)
Full fingered auger		●	●	●	●
Hydraulic reverser		●	●	●	●
Hydrostatic reel drive	rpm	11 - 79	11 - 79	11 - 79	11 - 79
Automatic functions					
AUTO CONTOUR		●	●	●	●
Reel speed control		●	●	●	●
Reel height adjustment		●	●	●	●

VARIO Heads

		VARIO 1200	VARIO 1050	VARIO 900
Effective cutting width	ft (m)	40 ft (11.97)	35 ft (10.44)	30 ft (9.14)
Cutting system				
Double knife		●	●	—
Single knife		—	—	●
Knife drive		synchronized transmission drive on both sides	synchronized transmission drive on both sides	v-belt driven
Spare knife		2 ●	2 ●	1 ●
Cutting frequency	strokes/min	1330	1330	1120
Spacing of knife to intake auger (adjustable from inside cab)	in (mm)	18.9-30.7 (480-780)	18.9-30.7 (480-780)	18.9-30.7 (480-780)
Spacing of knife to intake auger in canola	in (mm)	42.5 (1080)	42.5 (1080)	42.5 (1080)
Hydrostatic reel drive		●	●	●
Side knives		○	○	○
Automatic functions				
AUTO CONTOUR		●	●	●
Reel speed control		●	●	●
Reel height adjustment		●	●	●
Reel leveling system		●	●	●
Table position		●	●	●
Folding dividers		●	●	●
Crop lifters		●	●	●

CLAAS Corn Heads

Model	rows	row spacing	chopping row units	folding	Stalk stompers	AUTO PILOT	AUTO CONTOUR
18-20c	18	20	●	—	●	○	●
18-20	18	20	—	—	○	○	●
16-30c	16	30	●	—	●	○	●
16-30	16	30	—	—	○	○	●
12-30c	12	30	●	—	●	○	●
12-30	12	30	—	—	○	○	●
12-20c	12	20	●	—	●	○	●
12-20	12	20	—	—	○	○	●
8-30c	8	30	●	—	●	○	●
8-30	8	30	—	—	○	○	●
6-30	6	30	—	—	○	○	●

Capello® Corn Heads

Model	rows	row spacing	chopping row units	folding	Stalk stompers	AUTO PILOT	AUTO CONTOUR
12-30fc	12	30	●	●	●	—	●
12-30f	12	30	—	●	○	—	●
8-30fc	8	30	●	●	●	—	●
8-30f	8	30	—	●	○	—	●
6-30c	6	30	●	—	●	—	●

Heads

Draper Heads		MAXFLO 1200 40 ft (11.97)	MAXFLO 1050 35 ft (10.44)	MAXFLO 900 Rice 30 ft (9.14)	MAXFLO 750 Rice 25 ft (7.62)
Effective cutting width	ft (m)				
Combine header adapter		–	–	–	–
Center draper belt		–	–	–	–
Patented MAXFLO feeding system		●	●	●	●
Cutting system					
Double knife		●	●	–	–
Single knife		–	–	●	●
Knife drive		synchronized transmission drive on both sides	synchronized transmission drive on both sides	gearbox and over- load protection	gearbox and over- load protection
Spare knife		2 ●	2 ●	1 ●	1 ●
Cutting frequency	strokes/min	1150	1150	1150	1150
Stainless steel intake floor		●	●	●	●
In-cab draper belt reverser		●	●	●	●
In-cab draper belt speed adjustment		●	●	●	●
Side draper depth	in	40	40	40	40
Rear wall extension		●	●	●	●
Hydraulic reverser		●	●	●	●
Hydrostatic reel drive	rpm	11 - 79	11 - 79	11 - 79	11 - 79
Automatic functions					
Multi-sensor AUTO CONTOUR		●	●	●	●
Reel speed control		●	●	●	●
Reel height adjustment		●	●	●	●
Reel		split reel	split reel	single reel	single reel
Stabilization wheel		●	●	–	–
Crop lifters		○	○	–	–

Pick-up Heads		SWATH UP 450
Trough width	ft (m)	14 (4.5)
Pickup		
Drive		Hydraulic
Hydraulic crop down hold		●
Automatic pickup speed		●
Number of draper belts		4
Auger diameter	in (mm)	24 (610)
Auger speed	rpm	185
Overall width (to tire edges)	ft (m)	18.0 (5.5)
Header height sensors		●

Tires

Front Tires		780 / 780TT	760 / 760TT	750 / 750TT	740 / 740TT	730 / 730P	670 / 670TT
TERRA TRAC		○	○	○	○	–	○
1050/50R32	Michelin	○	○	○	○	○	○
900/60R32	Goodyear	●	●	●	●	●	●
900/60R32	Michelin	○	○	○	○	○	○
620/70R42	Goodyear	○	○	○	○	○	○
620/70R42	Michelin	○	○	○	○	○	○
520/85R42	Goodyear	○	○	○	○	○	○
Rear Tires							
500/85R30	Mitas/Continental	●	●	●	●	●	–
710/65R26	Titan	○	○	○	○	○	–
28LR26	Goodyear	○	○	○	○	○	●
750/65R26	Mitas/Continental	○	○	○	○	○	–

● Standard ○ Optional – Not Applicable



CLAAS of America Inc.
8401 S. 132nd Street
Omaha, NE 68138
Phone +1 (402) 861-1000
Fax +1 (402) 861-1003
www.claas.com

CL99881004 / 11/2014