

C1





FIAT, FIATAGRI TRACTOR MODELS AND TYPES



TRACTOR MODEL	ENGINE TYPE	CYLINDERS	CYLINDER DIAMETER
SOM35, SOM45, SOM50	OM CO1D	4	105
SOM40, SOM55	OM CO2D	4	108
SOM511, SOM512	OM CO1D/45	4	105
SOM612, SOM615	OM CO2S	4	108
SOM650	OM CN 3	3	110
SOM670	OM CO 3/60	4	110
SOM715	OM CO 3D/130	4	110
SOM750	OM CO 3/70	4	110
SOM800, SOM805C, SOM880/4	OM CO 3/75	4	110
SOM850	OM CO 3/80	4	110
SOM1300	OM CP3/100	6	110
250, 255, 300	8025.01	2	95
311, 311R, 312, 312R, 315	605D	4	82
350	8025.02	2	100
400, 420, 450, 460, 470	8035.01	3	95
411, 411R, 412, 412R, 415, 421, 431	615D	4	85
440, 446, 450, 455C, 466, 474, 480, 500, 505C	8035.02	3	100
505C SUPER, 565C, 566, 570, 580	8035.04	3	103
540	8035.02D	3	100
550	8045.01	4	95
600, 605C, 640, 665C, 666, 670, 680	8045.02	4	100
766, 780, 855C	8045.04	4	103
880/5, 955C	8055.04	5	103
900	8065.01	6	95
980, 1000	8065.02	6	100
1000S, 1000SUP, 1180	8065.04	6	103
1280, 138	8065.24 TURBO	6	103
1355C	8365.05	6	115
SERIE 46			
1580, 1880	8365.25 TURBO	6	115
55-46	8035.06	3	100
60-46	8035.05	3	104
65-46	8045.06	4	100
SERIE 55			
85-55C	8045.05	4	104
95-55	8055.05	5	104
100-55	8065.06	6	100
160-55C, 180-55C	8365.25 TURBO	6	115
SERIE 56			
55-56	8035.06	3	100
60-56L	8035.05	3	104
65-56L, 70-56L	8045.06	4	100
SERIE 76			
45-76V, 55-76V, 55-76F	8035.06	3	100
60-76F	8035.05	3	104
70-76LP, 70-76F, 70-76V	8045.06	4	100
80-76F	8045.05	4	104
SERIE 85			
55-85CF, 55-85V, 55-85M	8035.06	3	100
60-85CF, 60-85CV, 62-85C, 62-85CM	8035.05	3	104
72-85C, 72-85CM	8045.06	4	100
82-85C, 88-85C	8045.05	4	104
88-85M	8045.25 TURBO	4	104
SERIE 86			
50-86V	8035.06	3	100
60-86V, 60-86F, 62-86F	8035.05	3	104
70-86V, 72-86F, 72-86LP	8045.06	4	100
82-86F, 82-86LP	8045.05	4	104

TRACTOR MODEL	ENGINE TYPE	CYLINDERS	CYLINDER DIAMETER
SERIE 88			
55-88	8035.06	3	100
60-88	8035.05	3	104
65-88, 70-88	8045.06	4	100
80-88	8045.05	4	104
SERIE 90			
55-90	8035.06	3	100
60-90	8035.05	3	104
65-90, 70-90	8045.06	4	100
80-90	8045.05	4	104
85-90	8045.25 TURBO	4	104
90-90	8055.05	5	104
100-90	8065.06	6	100
110-90, 115-90	8065.05	6	104
130-90, 140-90	8065.25 TURBO	6	104
160-90, 180-90	8365.25 TURBO	6	115
SERIE 93			
60-93	8035.05	3	104
65-93, 72-93	8045.06	4	100
82-93	8045.05	4	104
88-93	8045.25 TURBO	4	104
SERIE 94			
60-94	8035.05	3	104
65-94, 72-94	8045.06	4	100
82-94	8045.05	4	104
88-94	8045.25 TURBO	4	104
SERIE 65			
55-65F, 55-65V, 55-65M	8035.06	3	100
60-65CM, 60-65CV	8035.05	3	104
70-65C	8045.06	4	100
SERIE 66			
35-66	CHD 1503	3	88
45-66, 45-66V, 50-66S, 55-66	8035.06	3	100
60-66	8035.05	3	104
65-66, 70-66, 70-66LP, 70-66F	8045.06	4	100
80-66, 80-66F	8045.05	4	104
SERIE 75			
55-75CF, 55-75M	8035.06	3	100
60-75CV, 60-75CM	8035.05	3	104
70-75C, 70-75CM	8045.06	4	100
80-75C	8045.05	4	104
SERIE WINNER			
F100 FINO	8065.06	6	100
F100DAL, F110, F120	8065.05	6	104
F115	8065.05R	6	104
F130	8065.25 TURBO	6	104
F140	8065.25 S TURBO	6	104
SERIE L			
L60	8035.05	3	104
L65	8045.06	4	100
L75	8045.05	4	104
L85	8045.25 TURBO	4	104
L95	8045.05K TURBO	4	104
SERIE G			
G170=8670			
G190=8770			
G210=8870			
G240=8970			
SERIE M			
M100=8160			
M115=8260			
M135=8360			
M160=8560			

C1.01

08.05.2009

Fiat engine overhaul kits STD include:

- pistons
- piston rings
- liners (semi-finished)
- complete gasket set
- front and rear crankshaft seals (if not incl. in gasket set)
- conrod bearings STD
- main bearings STD



K1000



T3131



T3257



T3138

TRACTOR MODEL	ENGINE OVERHAUL KIT STD (a)	COMPLETE PISTON	PISTON RING SET	LINER
411, 415		T3167 (d) 1909866	T3170 1909861	T3168 561212
450, 550			T3169 1901496	
500			T3140 1908737	
600, 640	K0200 (c)	T3129 (c, d) 1908744	T3140 1908737	T3136 4653280
650, 750, 850			T3141 1909236	
1000		T3129 (c, d) 1908744	T3140 1908737	T3136 4653280
1000 Super, 580		T3131 1908748	T3142 1909234	T3138 4679201
1300, 1300 Super			T3141 (b) 1909236	
680	K0200	T3129 (d) 1908744	T3140 1908737	T3136 4653280
780	K0201	T3131 1908748	T3142 1909234	T3138 4679201
880-4 cyl.	K0202		T3141 1909236	
880-5 cyl.	K0203	T3131 1908748	T3142 1909234	T3138 4679201
980		T3129 (d) 1908744	T3140 1908737	T3136 4653280
1180		T3131 1908748	T3142 1909234	T3138 4679201
1380				T3138 4679201
1580		T3134 (d) 1901492	T3144 1901487	T3139 2991786
1880, 1580T			T3257 1930753	T3139 2991786

a - set includes liners, pistons, piston rings, conrod bearings, main bearings and gaskets

b - four rings

c - combustion chamber in the middle in later than 1978, piston pin diameter 32 mm

d - includes piston rings

08.05.2009

Fiat engine overhaul kits STD include:

- pistons
- piston rings
- liners (semi-finished)
- complete gasket set
- front and rear crankshaft seals
(if not incl. in gasket set)
- conrod bearings STD
- main bearings STD



TRACTOR MODEL	ENGINE OVERHAUL KIT STD	COMPLETE PISTON	PISTON RING SET	CYLINDER
55-90, 65-90, 70-90		T3251 (c) 1930241	T3255 1908738	T3319 4770654
60-90, 90-90, 115-90, 110-90		T3252 (c) 1930186	T3256 1930191	T3320 4770623
80-90	K0205	T3252 (c) 1930186	T3256 1930191	T3320 4770623
100-90		T3251 (c) 4770654	T3255 1908738	T3319 4770654
130-90, 140-90		T3253 (b, c) 2991530	T3258 1902687	T3320 4770623
160-90 →26250			T3257 1930753	T3139 2991786
180-90 →26250			T3257 1930753	T3139 2991786
160-90 26251→		T3723 (a) 1930742	T3257 1930753	T3139 2991786
180-90 26251→		T3723 (a) 1930742	T3257 1930753	T3139 2991786
L60, L75		T3252 (c) 1930186	T3256 1930191	T3320 4770623
L65		T3251 (c) 1930241	T3255 1908738	T3319 4770654

a - combustion chamber chamfered from the valve side

b - new piston reinforced from upper end so that the upper end of conrod must be narrowed

c - includes piston rings

25.07.2008

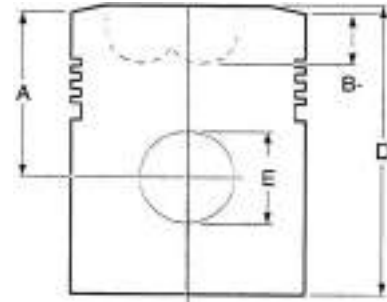
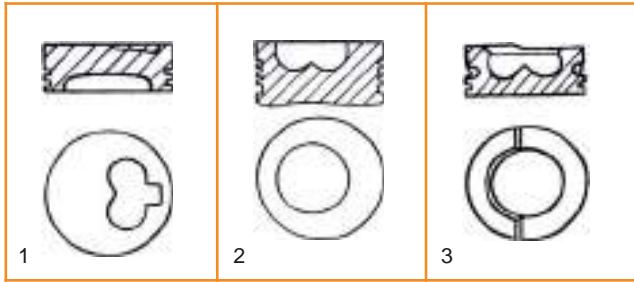

























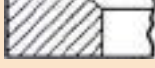

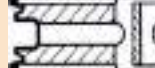



- A Compression height mm
- B- Combustion chamber depth mm
- D Overall length mm
- E Piston pin diameter mm
- F Piston pin length mm



ORDER NUMBER	MOTOR TYPE	∅	MODEL	PCS	STEEL REINFORCED	A	B-	D	E	F
T3167 1909866	615D	85	1	4		50,3	4,5	90	28	74,4
	8025.01 8035.01 8045.01	95	2	3		59,6	23,5	101,5	32	84
	8025.02 8035.02 8045.02 8065.02	100	2	3		59,6	23,7	101,15	32	84
T3251 1930241	8035.06 8045.06 8065.06	100	2	3		65,15	22,7	108,5	38	85
T3131 1908748	8035.04 8045.04 8055.04 8065.04	103	2	3		59,6	22,7	101,15	34	90
T3252 1930186	8035.05 8045.05 8055.05 8065.05	104	2	3		65,15	22,5	108,5	38	85
T3253 1930206	8045.25 8065.25	104	2	3	yes	65,15	22,5	108,5	38	89
T3134 1901492	8365.05	115	2	3	yes	76,5	29,4	140,5	42	97
T3723 1930742	8361.45	115	3	3	yes	76,5	27,7	140,5	42	97

06.10.2006

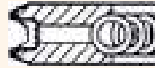
ORDER NUMBER	ENGINE TYPE	∅ mm				
T3169 1901496	8025.01 8035.01 8045.01	95	 2,5	 2,5	 5,5	
T3140 1909172	8025.02 8035.02 8045.02 8065.02	100	 2,5	 2,5	 5,5	
T3142 1909234	8035.04 8045.04 8055.04 8065.04	103	 2,5	 2,5	 4,0	
T3256 1930191	8035.05 8045.05 8055.05 8065.05	104	 2,5	 2,5	 4,0	
T3255 1930169	8035.06 8045.06 8065.06	100	 2,5	 2,5	 4,0	
T3170 1909861	615D	85	 3,0	 3,0	 3,0	 5,5
T3258 1930209	8045.25 8065.25	104	 3,0	 2,5	 4,0	
	8065.25	104	 3,0	 2,5	 4,0	
T3144 1901487	8365.05	115	 2,5	 2,5	 4,0	
T3257 1930753	8365.25	115	 3,0	 2,5	 4,0	

04.02.2008

- A - nominal bore diameter mm
- B - outer diameter mm
- C - flange diameter mm
- D - flange width mm
- E - overall length mm

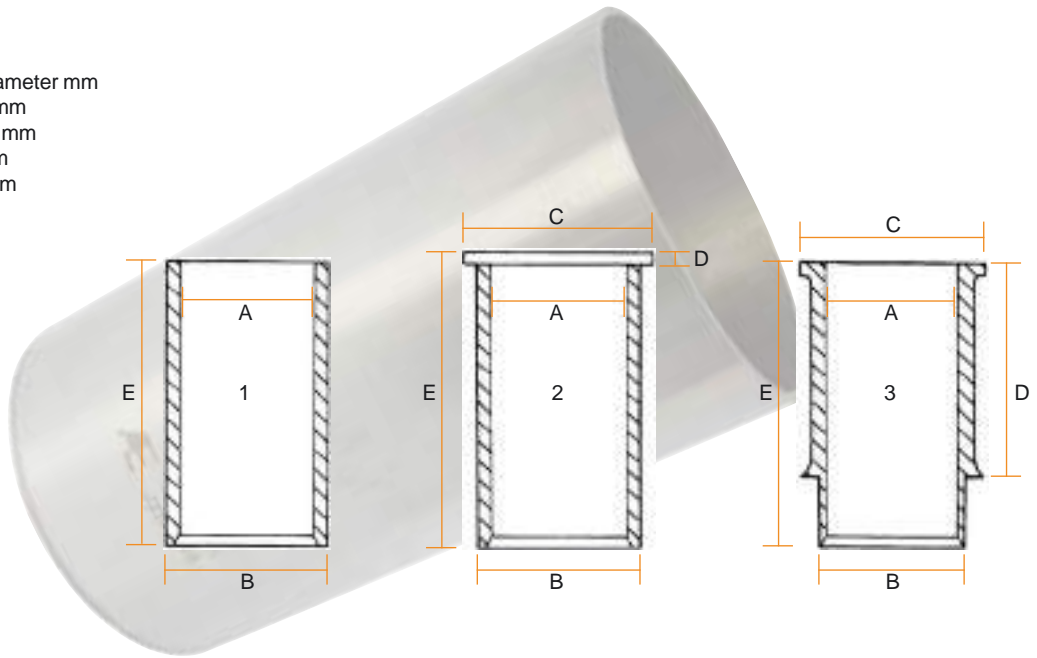

ORDER NUMBER	MODEL	A mm	B mm	C mm	D mm	E mm
T3168 561212	1	85	90,4			178
	1	95	99,1			187
T3136 4653280	1	100	103,06			187
T3319 4770654	1	100	103,06			196
T3138 4679201	1	103	107,1			187
T3320 4770623	1	104	107,1			198
	2	104	107,05	109,87	5	198
T3139 4850230	3	115	122	129,7	167	235

06.10.2006



T3145



T3279



T3276

TRACTOR MODEL	CONROD BEARING PAIR (a)	MAIN BEARING PAIR (a)	THRUST BEARING SET
640	T3145 x 4 1901609	T3279 x 5 1901803	T3275 (e) 1909996 T3276 (b) 1901377
640	T3145 x 4 1901609	T3279 x 5 1901803	T3275 (e) 1909996 T3276 (b) 1901377
780	T3145 x 4 1901609	T3279 x 5 1901803	T3275 (e) 1909996 T3276 (b) 1901377
750, 880 - 4 syl.	T3146 x 4 1901614		T3277 1901624
1000 Super, 980, 1180 6 cyl.	T3145 x 6 1901609	T3279 x 7 1901803	T3276 (b) 1901377



T3145



T3279



T3276



T3270

TRACTOR MODEL	CONROD BEARING PAIR (a)	MAIN BEARING PAIR (a)	COMPL. MAIN BEARING SET (a)	THRUST BEARING SET	SMALL END BUSH
312, 315	T3285 1909905				
411, 415, 441	T3286 1909856		T3288 1909893	T3290 902302	
450, 550	T3145 1901609	T3279 1901803		T3275 1909996	
600, 640	T3145 1901609	T3279 1901803		T3276 (b) 1901377	
650	T3146 1901614		T3292 1909459	T3277 1901624	
750, 850	T3146 1901614			T3277 1901624	
1000	T3145 1901609	T3279 1901803		T3275 1909996	
1000 Super	T3145 1901609	T3279 1901803		T3276 1901377	T3270 (d) 4754066
1300, 1300 Super	T3146 1901614		T3281 1901244	T3277 1901624	

a - also undersize bearings

b - from 1977

d - dimensions: T3270 37,9 x 34 mm

e - models 1971-1976

25.07.2008

Note!

T3282 main bearing set:
Check oil holes position!
(see picture below)



T3145



T3283



T3278



T3270

TRACTOR MODEL	CONROD BEARING PAIR (e)	MAIN BEARING PAIR (e)	COMPL. MAIN BEARING SET (e)	THRUST BEARING SET	SMALL END BUSH (g)
580	T3145 1901609	T3279 1901803		T3275 (h) 1909996 T3276 (f) 1901377	T3270 4754066
680	T3145 1901609	T3279 1901803		T3275 (h) 1909996 T3276 (f) 1901377	
780	T3145 1901609	T3279 1901803		T3275 (h) 1909996 T3276 (f) 1901377	T3270 4754066
880, 4-cyl.	T3146 1901614			T3277 1901624	
880, 5-cyl.	T3145 1901609	T3279 1901803		T3276 1901377	T3270 4754066
980	T3145 1901609	T3279 1901803		T3276 1901377	
1180, 1380	T3145 1901609	T3279 1901803		T3276 1901377	T3270 4754066
1580, 1880 1580 turbo	T3147 (c) 1901619		T3282 1901832	T3278 1901385	T3272 (b) 4771030
55-90, 60-90, 65-90, 70-90	T3266 1930181	T3283 1930176		T3278 1901385	T3273 4766404
80-90, 90-90, 100-90	T3266 1930181	T3283 1930176		T3278 1901385	T3273 4766404
115-90, 130-90	T3266 1930181	T3283 1930176		T3278 1901385	T3273 4766404
140-90	T3267 1930201	T3283 1930176		T3278 1901385	T3274 4783226
160-90, 180-90	T3268 (d) 1901993 tai T3147 (c) 1901619		T3282 1901832	T3278 1901385	T3272 4771030

b - 1580 from engine number 702097→, 1880 from engine number 750749→

c - **T3147** equipped with oil hole up to engine number →702096

d - **T3268** without oil hole from engine number 702097→

e - also undersize bearings

f - from model 1977→

g - dimensions 37,9 x 34 mm

h - models 1971-1976

08.05.2009

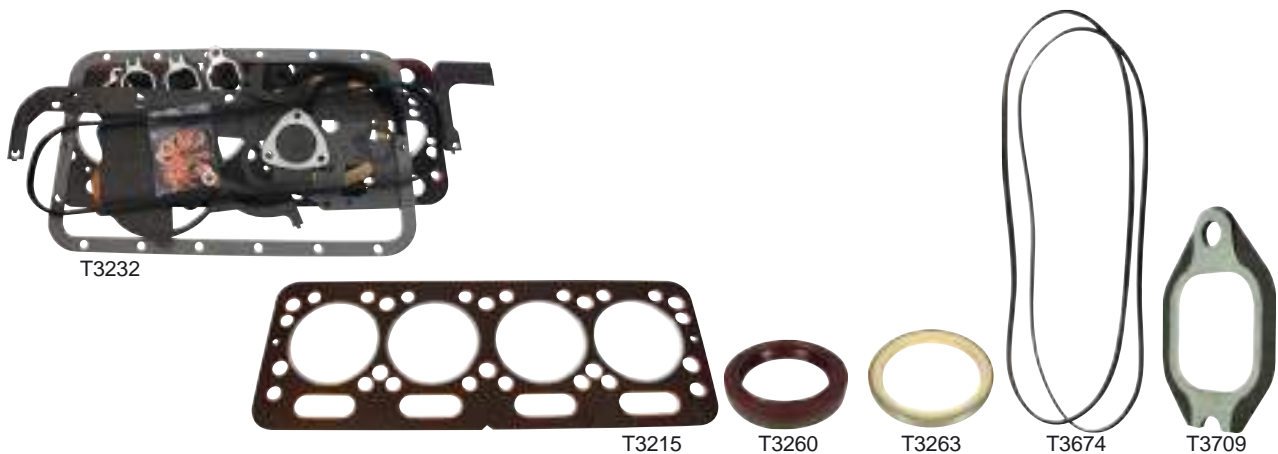

TRACTOR MODELS	COMPL. GASKET SET	CYLINDER HEAD GASKET	TIMING COVER OIL SEAL	REAR MAIN OIL SEAL	ROCKER COVER GASKET	MANIFOLD GASKET
312, 315	T3293	T3296				
411, 415, 441	T3294 (e,f)	T3297				
450			T3259 98461684	T3262 (a) 40000720		
640	T3232 1909567	FT98472008 98472008	T3259 98461684	T3262 (a) 40000720 T3263 (b) 40002811 T3265 (d) 98461686	T3672 4654363	T3709 4601981
650	T3318 (e,f) 1909565		T3260 40101393			
750		T3215 8818558	T3260 38819123		T3675 8816531	
850		T3215 8818558	T3260 38819123		T3675 8816531	
1000		FT98472010 98472010	T3259 98461684	T3262 (a) 40000720 T3263 (b) 40002811	T3674 4628453	T3709 4601981
1000 Super	T3242 1909543	FT98456219 (c) 98456219	T3259 98461684	T3263 (b) 40002811	T3674 4628453	T3709 4601981
1300			T3260 38819123		T3676 8829321	
1300 Super			T3260 38819123		T3676 8829321	

- a - 95 x 120 x13
- b - 110 x 135 x 13
- c - alternative original **FT98456219**
- d - 114 x 135 x 13
- e - gasket set doesn't include rear main oil seal
- f - gasket set doesn't include timing cover oil seal

08.05.2009



T3249



T3220



T3259



T3265



T3674



T3709

TRACTOR MODELS	COMPL. GASKET SET	CYLINDER HEAD GASKET	TIMING COVER OIL SEAL	REAR MAIN OIL SEAL	ROCKER COVER GASKET	MANIFOLD GASKET
580	T3231 1909590	T3216 4708955	T3259 98461684	T3263 (c) 40002811	T3671 4783243	T3709 4601981
680	T3232 (e,f) 1909567	FT98472008 98472008	T3259 98461684	T3263 (c) 40002811	T3672 4654363	T3709 4601981
780	T3233 1909983	FT98456215 98456215	T3259 98461684	T3263 (c) 40002811	T3672 4654363	T3709 4601981
880, 4-cyl.	T3149 (e,f) 1909551	T3215 8818558	T3260 8831405		T3675 8816531	
880, 5-cyl.	T3235 1930273		T3259 98461684	T3263 (c) 40002811	T3673 4783242	T3709 4601981
980		FT98472010 98472010	T3259 98461684	T3263 (c) 40002811	T3674 4628453	T3709 4601981
1180	T3245 (e,f) 1909543	T3224 (a) 4696355	T3259 98461684	T3263 (c) 40002811	T3674 4628453	T3709 4601981
1380		T3224 (a) 4696355	T3259 98461684	T3263 (c) 40002811	T3674 4628453	T3709 4601981
1580		FT4845364 4845364	T3260 8831405	T3264 40101400	T3676 8829321	
1880	T3248 1930369	FT4845364 4845364	T3260 8831405	T3264 40101400	T3676 8829321	
55-90			T3259 98461684	T3265 (d) 98461686	T3671 4783243	T3709 4601981
60-90			T3259 98461684	T3265 (d) 98461686	T3671 4783243	T3709 4601981
70-90, 65-90	T3238 (e,f) 1909563	FT98472008 98472008	T3259 98461684	T3265 (d) 98461686	T3672 4654363	T3709 4601981
80-90	T3239 (e,f) 1930248	FT98456215 98456215	T3259 98461684	T3265 (d) 98461686	T3672 4654363	T3709 4601981
90-90		FT1940075 1940075	T3259 98461684	T3265 (d) 98461686	T3673 4783242	T3709 4601981
100-90	T3249 (e,f) 1930859	FT98472010 98472010	T3259 98461684	T3265 (d) 98461686	T3674 4628453	T3709 4601981
115-90, 130-90, 140-90	T3250 (e,f) 1940051	T3224 (a) 4696355	T3259 98461684	T3265 (d) 98461686	T3674 4628453	
160-90, 1580 turbo	T3669 1930369	FT4845364 4845364	T3260 8831405	T3264 40101400	T3676 8829321	
180-90	T3248 1930369	FT4845364 4845364	T3260 8831405	T3264 40101400	T3676 8829321	
110-90	T3250 (e,f) 1940051	T3224 (a) 1909612	T3259 98461684	T3265 (d) 98461686	T3674 4628453	T3709 4601981
F110, 115, 120, 130	T3250 (e,f) 1940051	T3224 (a) 1909612	T3259 98461684	T3265 (d) 98461686		
F140		T3224 (a) 1909612	T3259 98461684	T3265 (d) 98461686		

a - alternative original **FT98456219**

c - 110 x 135 x 13

d - 114 x 135 x 13

e - gasket set doesn't include rear main oil seal

f - gasket set doesn't include timing cover oil seal

C1.10

06.10.2006



T3311



T3312



T3315



T3727

TRACTOR MODELS	INLET VALVE	EXHAUST VALVE	INLET GUIDE	EXHAUST GUIDE	VALVE SPRING
411, 412, 415, 421, 431	T3303 4579416	T3304 4579417			
450, 550, 600, 640, 1000, 1000 Super	T3299 4621511	T3300 4673608	T3315 4684422	T3315 4684422	T3726 4689554
650, 750, 850	T3301 8823545	T3302 8823544	T3316 4758794	T3317 4758798	
1300, 1300 Super		T3302 8823544	T3316 4758794	T3317 4758798	
580, 680, 780, 880 5-cyl., 980, 1180	T3299 4621511	T3300 4673608	T3315 4684422	T3315 4684422	T3726 4689554
880 4-cyl.	T3301 8823545	T3302 8823544	T3316 4758794	T3317 4758798	
1380	T3307 4621511	T3308 4673608	T3315 4684422	T3315 4684422	
1580, 1880, 1580T	T3309 4821709	T3310 8830045	T3316 4758794	T3317 4758798	
55-90, 60-90, 65-90, 70-90,80-90, 85-90, 90-90, 100-90, 110-90, 115-90, 130-90, 140-90	T3311 4824417	T3312 4784889	T3315 4684422	T3315 4684422	T3727 4780108
160-90, 180-90	T3309 4821709	T3310 8830045	T3316 4758794	T3317 4758798	

08.05.2009



**7 good reasons
to change new nozzles:**

1. saves fuel
2. engine's longer service life
3. cleaner exhaust
4. more power
5. higher torque
6. better start-up
7. smoother running



SD72061



T3115



T3063

TRACTOR MODEL	INJECTOR NOZZLE	COMPARABLE	MOTOR OIL PUMP	OIL PRESSURE SWITCH
450, 640	SD72031 4760843	DLL140S64F	T3115 4705827	T3063 4151243
850	SD72024 4758260	DLL150S51F		
1000	SD72031 4760843	DLL140S64F		T3063 4151243
1300	SD72024 4758260	DLL150S51F		T3063 4151243
580, 680, 780	SD72031 4760843	DLL140S64F	T3115 4705827	T3063 4151243
880 4-cyl.	SD72024 4758260	DLL150S51F		T3063 4151243
880 5-cyl., 980, 1180	SD72031 4760843	DLL140S64F		T3063 4151243
1380	SD72031 4760843	DLL140S64F		T3063 4151243
1580, 1880, 1580T	SD72039 4750416	DLL145S73F		T3063 4151243
55-90, 70-90	SD72060 4791689	DLL124S500W	T3115 4705827	T3063 4151243
60-90, 80-90	SD72061 4776715	DLL136S501W	T3115 4705827	T3063 4151243
90-90, 100-90, 115-90, 130-90, 140-90	SD72061 4776715	DLL136S501W DLL136S1000	T3353 4770250	T3063 4151243
160-90, 180-90	SD72039 4750416	DLL145S73F		T3063 4151243
F100, F110, F120, F130, F140		DLLA137S1208	T3353 4770250	T3063 4151243
446, 450, 45-66, 460, 466, 470, 480, 480-8F, 500, 50-66, 540, 550, 55-66, 55-66F, 55-76F, 55-90, 566, 570, 580, 600, 60-60, 60-66, 60-66F, 60-76F, 60-90, 60-93, 60-94, 640, 65-66, 65-90, 65-93, 65-94, 666, 670, 680, 70-66, 70-66F, 70-76F, 70-90, 72-93, 72-94, 766, 780, 80-66, 80-66F, 80-76F, 80-90, 82-93, 82-94			T3115 4705827	
110-90, 55-65, 55-66, 55-90, 60-65, 60-90, 65-90, 70-65, 70-90, 80-65, 80-66, 80-90, 85-55, 90-90, 95-55				T3063 4151243

08.01.2007

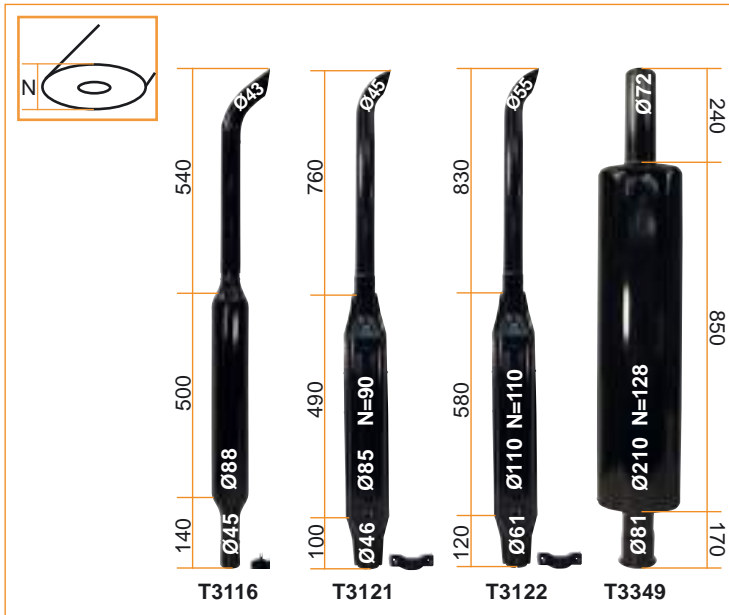

TRACTOR MODEL	EXHAUST PIPE	EXHAUST CLAMP	FUEL TANK CAP	FUEL TANK ARMATURE	FUEL LIFT PUMP	INLET MANIFOLD
450, 640	T3116 5011631		T3344 5118532		T3113 4757883	T3062 5161845
750	T3122 (b) 5101811	T3614 5116798	T3344 5118532		T3183 (a) 763150	
850	T3122 (b) 5101811	T3614 5116798			T3183 (a) 763150	
1000	T3122 (b) 5101811	T3614 5116798			T3114 4709284, 4757884	T3062 5161845
1300	T3122 (b) 5101811	T3614 5116798	T3061 5105346		T3183 (a) 763150	T3062 5161845
580, 680, 780	T3121 4997328	T3613 5116798	T3061 5105346	T3024 5136771	T3113 4757883	T3062 5161845
880 4-cyl., 880 5-cyl., 980	T3122 (b) 5101811	T3614 5116798	T3061 5105346	T3024 5136771	T3114 4709284, 4757884	T3062 5161845
1180	T3122 (b) 5101811	T3614 5116798	T3061 5105346	T3334 5136772	T3114 4709284, 4757884	T3062 5161845
1380	T3122 (b) 5101811	T3614 5116798	T3061 5105346	T3334 5136772	T3342 4709284	T3062 5161845
1580	T3349 5109906		T3061 5105346	T3334 5136772	T3183 (a) 763150	T3062 5161845
1880 160-90, 180-90	T3349 5109906		T3061 5105346	T3334 5136772		T3062 5161845
55-90, 60-90, 70-90, 80-90, 65-90	T3121 4997328	T3613 5116798	T3061 5105346	T3024 5136771	T3113 4757883	T3062 5161845
90-90, 100-90, 110-90	T3122 (b) 5101811	T3614 5116798	T3061 5105346	T3024 5136771	T3114 4709284, 4757884	T3062 5161845
115-90	T3122 (b) 5101811	T3614 5116798	T3061 5105346	T3024 5136771		T3062 5161845
130-90, 140-90	T3122 (b) 5101811	T3614 5116798	T3061 5105346	T3334 5136772		T3062 5161845
F100, F110, F120, F130					T3728 98419724	T3062 161845
L60, L65, L75, L85, L95 TL65, TL70, TL80, TL90, TL100					T3113 4757883	

a - glass bowl for fuel lift pump T5113 Ø 39 mm, height 52 mm
b - T3122A straight top pipe

FUEL BOWL

V299



17,5 mm

FUEL LIFT PUMP

F82006984

82006984

- electric
- fits M100, M115, M135, M160



25.07.2008

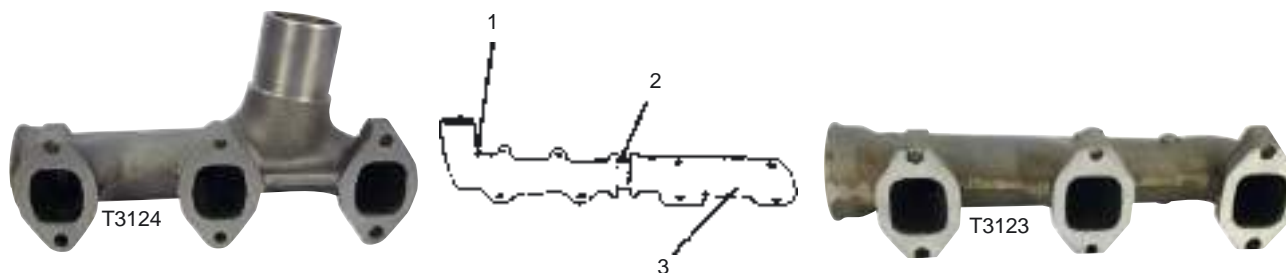

TRACTOR MODEL	1 FRONT PART	2 COUPLING	3 REAR PART
980, 1180, 100-90, 110-90	T3124 4717758	T3125 4602270	T3123 4817497
880-5 syl., 90-90, 115-90	T3124 4717758	T3125 4602270	

WATER PUMPS

T3054

566997
- 411, 415



T3055

4679242
- 450, 500, 550, 600, 640,
1000, 480, 880 5-cyl.,
980, 1180, 1380



T3198

8829787
- 650, 750, 850



T3195

4696707
- 580, 680, 780



T3197

8829790
- 880 4 cyl.



T3200

4796534
- 1580, 1880, 160-90,
180-90



F0664

87801641
- M100, 115, 135, 160
TM120, 130, 140



T3196

4784454, 98403016,
4813370
- →12/92:45-66, 50-66, 55-46,
55-65, 55-66, 55-90, 60-46,
60-65, 60-66, 60-90, 65-46,
65-66, 65-90, 70-65, 70-66,
70-90, 80-65, 80-66, 80-90,
85-55, 90-90, 95-55,
100-90, 115-90, 130-90,
140-90, F100, F110, F115,
F120, F130, F140



T3685

98465322, 98497117
- 01/93→12/95:
45-66, 50-66, 55-46,
55-65, 55-66, 55-90, 60-46,
60-65, 60-66, 60-90, 65-46,
65-66, 65-90, 70-65, 70-66,
70-90, 80-65, 80-66, 80-90,
85-55, 90-90, 95-55,
100-90, 115-90, 130-90,
140-90, "76", "86", "93",
"94", F100, F110, F115,
F120, F130, F140



T3756

8013363, 99454833
- 01/96→:
45-66, 50-66, 55-46,
55-65, 55-66, 55-90, 60-46,
60-65, 60-66, 60-90, 65-46,
65-66, 65-90, 70-65, 70-90,
80-65, 80-66, 80-90, 85-55,
90-90, 95-55, 100-90,
115-90, 130-90, 140-90,
TN65F, TN75F, TN90F, "76",
"86", "93", "94",
L60, 65, 75, 85, 95 (95→),
TL70, 80, 90, 100 (98→),
TN55, 65, 75, 90 (98→)



F0665

87802496
- TM155, 175, 190

25.07.2008



T3754



T3692



T3692A



TRACTOR MODEL	WATER PUMP REPAIR KIT	THERMOSTAT	WATER PUMP CONNECTOR	GASKET O-RING
311, 312, 315	T3212 589323	T2041 4086415		
411, 415	T3056 1909619	T2041 4086415		
450, 500, 550 600, 640		T3754 4569187	T3691 4615794	T3691A 4673810 T3691B 024600
650, 750, 850		T3209 8826010		
1000		T3754 4569187	T3691 4615794	T3691A 4673810 T3691B 024600
480		T3754 4569187	T3691 4615794	T3691A 4673810 T3691B 024600
580, 680, 780		T3754 4569187	T3691 4615794	T3691A 4673810 T3691B 024600
880 4-cyl.		T3209 8826010		
880 5-cyl., 980, 1180, 1380		T3754 4569187	T3691 4615794	T3691A 4673810 T3691B 024600
1580, 1880		T3208 4808727		
160-90 180-90		T3208 4808727		
→ 12/92: 45-66, 50-66, 55-46, 55-65, 55-66, 55-90, 60-46, 60-65, 60-66, 60-90, 65-46, 65-66, 65-90, 70-65, 70-66, 70-90, 80-65, 80-66, 80-90, 85-55, 90-90, 95-55, 110-90, 100-90, 115-90, 130-90, 140-90, F100, F110, F115, F120, F130, F140		T3754 4569187	T3692 4770247	T3692A 4848840 T3692B
01/93→12/95: 45-66, 50-66, 55-46, 55-65, 55-66, 55-90, 60-46, 60-65, 60-66, 60-90, 65-46, 65-66, 65-90, 70-65, 70-66, 70-90, 80-65, 80-66, 80-90, 85-55, 90-90, 95-55, 100-90, 110-90, 115-90, 130-90, 140-90, 76-, 86-, 93- and 94-series, F100, F110, F115, F120, F130, F140		T3754 4569187		
01/96→: 45-66, 50-66, 55-46, 55-65, 55-66, 55-90, 60-46, 60-65, 60-66, 60-90, 65-46, 65-66, 65-90, 70-65, 70-90, 80-65, 80-66, 80-90, 85-55, 90-90, 95-55, 100-90, 110-90, 15-90, 130-90, 140-90, TN65F, TN75F, TN90F, 76-, 86-, 93- and 94-series, L60, L65, L75, L85, L95 (95→), TL70, TL80, TL90, TL100 (98→), TN55, TN65, TN75, TN90 (98→)		T3754 4569187		
M100, M115, M135, M160		VPE3405 87800842		

06.10.2006



T3615

4973345, 4952981,
4952983, 4956666

- fits:

480, 500, 540, 550, 600, 640
55-56, 55-66, 55-88, 60-56, 60-66, 60-75, 60-88,
90-93, 60,94, 65-56, 65-66, 65-88, 65-93, 70-56,
70-66, 70-88, 72-93

- 4-rows

- overall height 660 mm



T3724

5143883, 4997175

- fits:

580, 680, 780, 880,
55-90, 60-90,
65-90, 70-90,
80-90

- 3-rows



T3725

5143884, 4997926

- fits:

780, 880, 980, 60-90,
70-90, 80-90, 90-90,
100-90, 110-90

- 4-rows

- overall height 700 mm



T3757

5119698, 5123209,
5123208, 5129229

- fits:

1580, 1880,
130-90, 140-90,
160-90, 180-90

- overall height 865 mm

25.07.2008



AVX10-1000



T3374



T3360

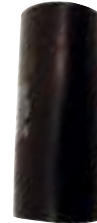

T4013

See Accessories catalog
page T6.16c for fan belt
reference table.

TRACTOR MODEL	FAN BELT	FAN BLADES	RADIATOR CAP	RADIATOR TOP HOSE	RADIATOR BOTTOM HOSE
450, 640	AVX10-1175 4796327		T3360 4999682	T3362 4950088	T4013 596152
750, 850	AVX13-1325 44010698		T3360 4999682		
1000	T3356 x 2 4796327	T3374 4705372	T3360 4999682		T3365 597054
1300	AVX13-1325 x 2 44010698		T3360 4999682		
580, 680, 780	AVX10-1175 4796327		T3360 4999682	T3367 4997263	T4013 596152
880 4-cyl.	AVX10-1300 4712148		T3360 4999682	T3368 4997336	
880 5-cyl., 980	T3356 x 2 4796327	T3374 4705372	T3360 4999682	T3367 4997263	T4013 596152
1180	AVX10-1175 x 2 4796327	T3374 4705372	T3360 4999682	T3370 5107001	T4013 596152
1380	T3356 x 2 4796327		T3360 4999682	T3370 5107001 T3371 5121678	T4013 596152
1580, 1880	AVX10-1350 x 2 4796442		T3361 5129231	T3372 5106829	
55-90, 60-90, 70-90, 80-90	AVX10-1175 4796327		T3360 4999682	T3367 4997263	T4013 596152
90-90	AVX10-1175 x 2 4796327	T3374 4705372	T3360 4999682	T3367 4997263	T4013 596152
100-90	AVX10-1175 x 2 4796327	T3374 4705372	T3360 4999682	T3367 4997263	T4013 596152
115-90	AVX10-1175 x 2 4796327	T3374 4705372	T3361 5129231	T3371 5121678	T4013 596152
130-90, 140-90	AVX10-1175 x 2 4796327		T3361 5129231	T3371 5121678	T4013 596152
160-90	AVX10-1350 x 2 4796442		T3361 5129231	T3372 5106829	
180-90	AVX10-1350 x 2 4796442		T3361 5129231	T3372 5106829	

25.07.2008

For tractors marked with number 1 on cylinder head



T3488



LUK331009210



LUK328009116



L6014-2RS



L6303-2RS

TRACTOR MODEL		COMPLETE CLUTCH ASSEMBLY incl. clutch plate	CLUTCH PLATE	P.T.O. CLUTCH PLATE	CLUTCH PRESSURE PLATE	RELEASE BEARING	P.T.O. BEARING	PILOT BEARING
312, 315, 411, 415	9"		T3737 4968740					
450, 480	10"		T3721 4968734					
550, 600, 640, 580, 680, 780	11"	(k)	T3022 (l) 5150650, 4999812 organic	LUK328009116 5160411		T3015 5122028	L6014-2RS 24905360	L6303-2RS 28043280
880 4-syl.	11"	(k)				T3015 5122028	L6014-2RS 24905360	L6303-2RS 28043280
55-90, 60-90 65-90, 70-90	11"	T3487(c) 805656 organic	T3022 (l) 5150650, 4999812 T3495 (m) 5145708	LUK328009116 (h) 5160411 LUK328018616 5154703	T3505	LUK500045900 5122028	L6014-2RS 24905360	L6303-2RS 28043280
70-90, 80-90 85-90	11"	T3488(c) 5150646 ceramic	T3496 5150647	LUK328009116 (h) 5160411 LUK328018616 5154703	T3505	LUK500045900 5122028	L6014-2RS 24905360	L6303-2RS 28043280
850, 1000	12"		T3494 5160410					L6304-2RS(f) 410001710 L6204-2RS(g) 5120853
880 4-cyl.	12"	(k)					L6014-2RS 24905360	L6304-2RS 410001710
880 5-cyl., 980, 90-90, 100-90, 110-90	12"	(k)	T3492 5150922 ceramic or T3059A 5112856 organic				L6014-2RS 24905360	L6204-2RS 5120853
90-90 100-90 110-90	12"	T3665 (e) 5144020	LUK331009210 5144740	LUK331013216 5154514		LUK500045900 5122028	L6015-2RS 5112084	L6204-2RS 5120853
1180 115-90	12"	(k)		LUK331013016 5154551		LUK500005910 5120853	LUK500005810 44016827	L6204-2RS 5120853

b - 2/80 → complete

c - When assembling new T3487 or T3488 assembly, P.T.O. plate LUK328018616 (7,6 mm) must definitely be used. Can be replaced with LUK clutches on the next page (LUK228007714 and LUK228007710).

d - toggle lever finger set

e - when assembling new T3665 assembly, P.T.O. plate LUK331013216 (7,6 mm) must definitely be used. Can be replaced with LUK clutch LUK231004911.

f - 850

g - 1000

h - LUK328009116 thickness 8,6 mm, LUK328018616 thickness 7,6 mm, LUK331013216 thickness 7,6 mm

k - see page C1.20

l - fixed

m - springed

08.05.2009

For tractors marked with number 2 or 3 on cylinder head



LUK228007714



T3022



LUK331009516



T3020



LUK500005910



LUK500039300



L6303-2RS

TRACTOR MODEL	COMPLETE CLUTCH ASSEMBLY includes clutch plate	CLUTCH PLATE	P.T.O. CLUTCH PLATE	TOGGLE LEVER FINGER SET (c)	RELEASE BEARING	P.T.O. BEARING	PILOT BEARING
(k): 550, 600, 640, 580, 680, 780	LUK228007714(a,d,1) 5106755 LUK228007710(b,d,1) 5145717	T3022 (a) 5150650 LUK328018510 (b) 5145718	LUK328009116 (f) 5160411 LUK328018616	T3020 9962518	LUK500045900	L6014-2RS	L6303-2RS
55-90, 60-90, 70-90, 80-90, 65-90, 85-90 11"	LUK228007714(a,d,1) 5106755 LUK228007710(b,d,1) 5145717	T3022 (a) 5150650 LUK328018510 (b) 5145718	LUK328009116 (f) 5160411 LUK328018616	T3020 9962518	LUK500045900	L6014-2RS	L6303-2RS
650, 750 12"		T3474 (i) 9004183	LUK331009516 (h) 9004189		LUK500045900	L6014-2RS	L6304-2RS
850, 880 4 cyl.11"	LUK228003110(1) 5107183	LUK328007410 5102262	LUK328009216 5160410	T3020 9962518	LUK500045900	L6014-2RS	L6304-2RS
880 4 cyl., 880 5cyl., 980, 90-90, 100-90, 110-90 90-95 12"	LUK231004911(e,1,p) 5154514 LUK231004919 (q) 5163936	LUK331009210(b) 5144740 (6-blade spring) LUK331013119 5163937 (7-blade spring) T3059A (a)	LUK331013216 5156514		LUK500045900	L6015-2RS 5112084	L6304-2RS (880-4) L6204-2RS
1000 13"							L6204-2RS
1180, 115-90 12"	LUK231005010 (1) 5144661		LUK331009516 9004189		LUK500005910 5120853	LUK500005810 44016827	L6204-2RS
1580, 1880, 160-90, 180-90 12"	LUK631026109(1, 2) 5140361	LUK331010310 5118453			LUK500005910 5120853		
L60	LUK628191009 (m, 1)						
L65	LUK231008910 (1) 5167933	LUK330005110 5167928			LUK500045900	LUK500039300	LUK410002500
L75, L85 TL80, TL90	LUK231008810 (1)	LUK331021910 5167936			LUK500045900	LUK500039300 5167183	LUK410002500 28043280

a - organic
b - ceramic

c - set for one clutch

d - When assembling new **LUK228007714** or **LUK228007710** assembly, P.T.O. plate **LUK328018616** (7,6 mm) must definitely be used. Can be replaced with clutches **LUK328009216**, **T3487** and **T3488** on previous page.

e - When assembling new **LUK231004911** assembly, P.T.O. plate **LUK331013216** (7,6 mm) must definitely be used. Can be replaced with Valeo **T3665** on previous page.

f - thickness **LUK328009116** = 8,6 mm **LUK328018616** = 7,6 mm

g - thickness **LUK331013216** = 7,6 mm

h - 11 splines, diameter 32mm

i - 18 splines, diameter 50mm

k - these models appear with two different kind of clutch shaft. Check suitability before fitting!

m - including assembly and drive plate

p - includes drive plate C-6

q - includes drive plate C-7

1 - drive clutch plate

2 - P.T.O clutch plate



FIAT, FIATAGRI FERODO VALEO

Early FERODO-clutches replacement with new VALEO 6-fingers clutches



25.07.2008



TRACTOR MODEL		ASSEMBLY includes drive clutch plate	CLUTCH PLATE DRIVE gear box side	CLUTCH PLATE P.T.O. flywheel side	COMPL. CLUTCH SET incl. assy, drive- and P.T.O. clutches and release bearing(e)	RELEASE BEARING COMPL.	PILOT BEARING
550, 600, 640, 580, 680, 780	280 mm	M600 5177193 (T3480) (f) 5150650	D537C (c) 5150653 T3022 (d) 5150650	LUK328018616 5152710	K200E (g) 1930987	R242 5177194	L6303-2RS 28043280
850, 1000	310 mm	(T3485) (f) 5177203	T3494 44015757		K204E (h) 1930990	R246 5177204	L6304-2RS (a) 410001710 L6204-2RS (b) 5120853
880, 880/5, 980, 90-90, 100-90, 110-90	310 mm	M602 5177196 (T3483) (f)	T3492 5150922	LUK331013216 5152736	K202E (h) 1930988		L6204-2RS 5120853
1180, 115-90	310 mm	M603 5177199 (T3484) (f)	D538C 5151000	LUK331013016 5151001		R245 1930989	L6204-2RS 5120853

a - 850

b - 1000

c - ceramig

d - organic

e - the set includes assembly, clutch plates and complete release bearing

f - old order number

g - when assembling, 6 pcs of bolts is needed, order number **PKH10090125**

h - when assembling, 6 pcs of bolts is needed, order number **PKH10100125**

When replacing early type clutch, new complete release set and P.T.O. clutch plate must be changed. In this case we recommend complete clutch set.

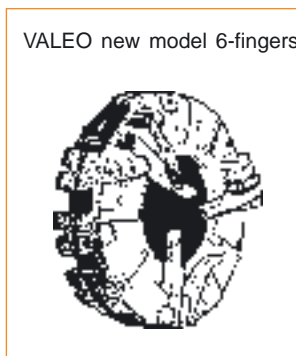
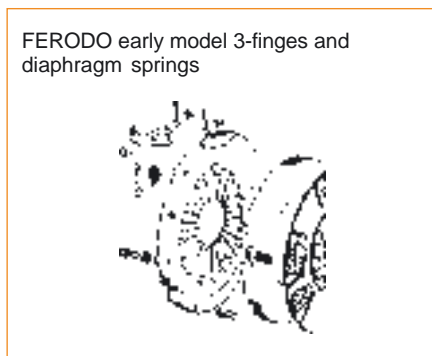

HUB GREASE

LUK414001410
- especially for clutch centres and shafts

C1.20

08.05.2009



LUK135021510



LUK333007211

TRACTOR MODEL		COVER ASSY	CLUTCH PLATE	RELEASE BEARING
1180, 1380, 1580, 1880	14"	LUK135020510 (3) 5123061	LUK335012910 5150080 T3472 5118453	T3465 5121414
115-90, 130-90, 140-90	14"	LUK135020510 (3) 5123061	LUK335012910 5150080 T3472 5118453	T3465 5121414
Winner F100, F110, F115, F120 New Holland M100, M115	330 mm	LUK133021410 (3) 5154418	LUK333007211 5165650	T3684 5149611
Winner F130, F140 New Holland M135	350 mm	LUK135021510 (3) 88203039	LUK335012910 5150080	T3684 5149611
L85, L95 New Holland M135, TL90	310 mm	LUK131024910 (3) 5167939, 5189823	LUK331021910 5167939	

3 - no plate

SPRING CLUTCH SLEEVE

FT44011615

44011615

- 100-90, 110-90, 115-90, 130-90, 140-90, 160-90, 180-90, 55-90, 60-90, 65-90, 70-90, 80-90, 85-90, 90-90,
L60, L65, L75, L85, L95, TL60, TL65, TL70, TL80, TL90, TL100

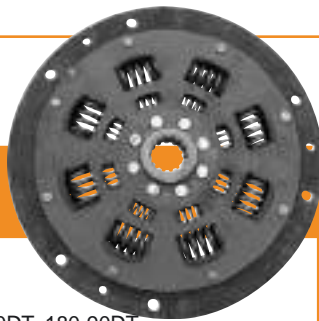

BALANCE WHEEL DAMPER

LUK370001110

5153359

- 130-90DT, 140-90DT, 160-90DT, 180-90DT
- Power Shift -gearing



BALANCE WHEEL DAMPER

LUK370000910

82008857

- 5640, 6640, 7740, 7840, 8240, 8340,
TS90, TS100, TS110 TS115
- Power Shift -gearing



BALANCE WHEEL DAMPER

LUK370001010

5187845

- 8160, 8260, 8360, 8560, M100, M115, M135, M160,
TM115, TM125, TM135, TM150, TM165
- Power Shift -gearing



BALANCE WHEEL DAMPER

LUK370001710

5187958

- TL70, TL80, TL90, TL100
- Power Shift -gearing

25.07.2008

450
480
500
550
580
600
640
680
780

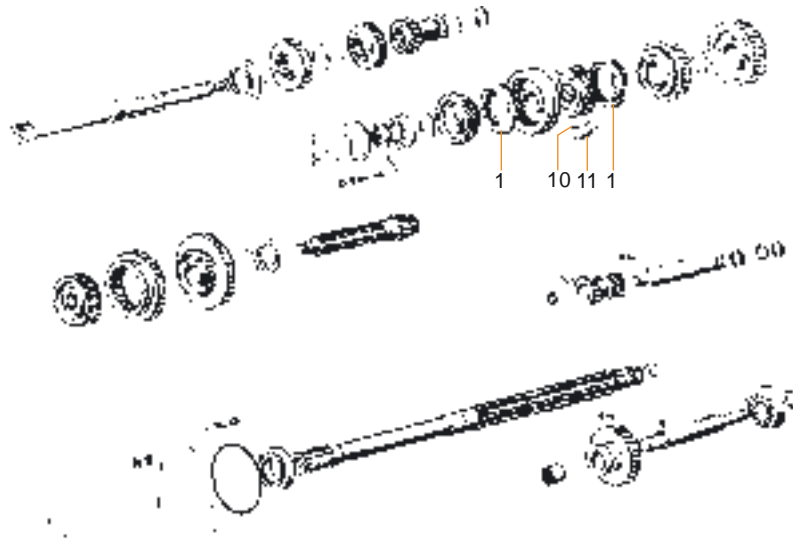

450
480
580
640
680
780
880
980
1180
1380
1580

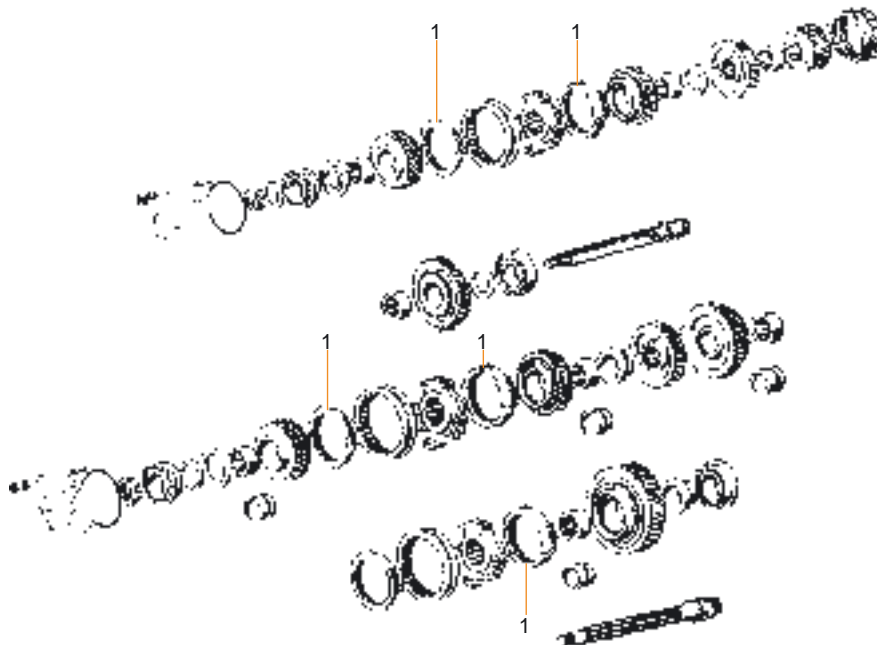

PART	315	450	480	500	580	780	880	980	1180
	415	640	600	550	680			1580	1380
1. Synchronizer	T3007 5118187	T3007 5118187	T3007 5118187	T3007 5118187	T3007 5118187	T3007 5118187	T3007 5118187	T3007 5118187	T3007 5118187
10. Coupling		T3011 4568626	T3011 4568626	T3011 4568626			T3011 4568626	T3011 4568626	
11. Spring		T3012 4572860	T3012 4572860	T3012 4572860			T3012 4572860	T3012 4572860	
CLUTCH SHAFT AND GEAR BOX OIL SEALS	780 580 680	600 640	880 4-syl. 880 5-syl. 980, 90-90, 100-90	55-90 60-90 70-90 80-90	115-90 130-90	650	1180, 1380, 1580, 1880, 140-90 160-90 180-90		
Clutch shaft seal	OAS456210 40000270 BIRD	OAS456510 40000370	OAS50689 5106069	OAS458510 5123299	OAS557010 5112307	OAS557510 44014376	OAS557010 5112307		
Gear box rear main seal	OAS25357 5105887		OAS28387 5106073		OAS32427 5112294				

08.05.2009

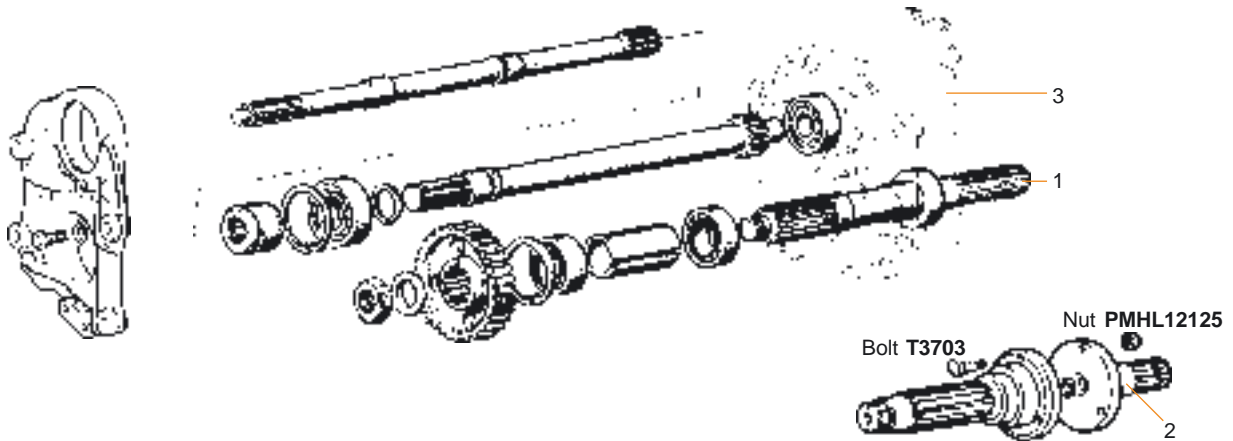

TRACTOR MODEL	1.	2.		3.
	P.T.O. SHAFT 1-speed	P.T.O. SHAFT with 2-speeds flange		REAR HOUSING 2-speeds
		540 1/min 1 3/8 6Z	540 1/min 1 3/4 6Z	
750	T3074 44017106	T3074 44017106	T3075 5158578	
1000		T3074 44017106	T3075 5158578	
850, 1000 Super		T3074 44017106	T3075 5158578	
1300, 1300 Super		T3074 44017106	T3075 5158578	
580, 680, 780	T3030 4998230	T3074 44017106	T3075 5158578	T3612 5143642
880 4 cyl., 880 5 cyl.		T3074 44017106	T3075 5158578	T3612 5143642
980		T3074 44017106	T3075 5158578	T3612 5143642
1180, 1380, 1580, 1880		T3074 44017106	T3075 5158578	
60-90, 70-90, 80-90		T3074 44017106	T3075 5158578	
110-90, 90-90, 100-90		T3074 44017106	T3075 5158578	T3612 5143642
115-90, 130-90, 140-90, 160-90, 180-90		T3074 44017106	T3075 5158578	
F100, F110, F115, F120, L60, L65, L75, L85, L95, M100, M115, M135, M160, TL65, TL70, TL80, TL90, TM110, TM120, TM130, TM140			T3075 5158578	

TRANSVERSE GEAR

FT4984103
4984103
- 880-110-90
- drive P.T.O.



P.T.O. GEAR

FT4995695
4995695
- 880-110-90
- to pinion shaft





FIAT, FIATAGRI HYDRAULIC POWER CLUTCH



T3096



T3528



T3529



OAS508010

TRACTOR MODEL	HYDRAULIC P.T.O. CLUTCH	CLUTCH PLATE SET	CLUTCH HYDRAULIC PUMP	P.T.O. SEAL
1180	T3096 5107939	T3528 9968954	T3529 5135305	
1380	T3096 5107939	T3528 9968954	T3529 5135305	
1580	T3096 5107939	T3528 9968954	T3529 5135305	
1880	T3096 5107939	T3528 9968954	T3529 5135305	
115-90	T3096 5107939	T3528 9968954	T3529 5135305	
130-90	T3096 5107939	T3528 9968954	T3529 5135305	
140-90	T3096 5107939	T3528 9968954	T3529 5135305	
160-90	T3096 5107939	T3528 9968954	T3529 5135305	
180-90	T3096 5107939	T3528 9968954	T3529 5135305	
680, 780, 880 4-cyl., 880 5-cyl., 90-90 1-speed				OAS558510 5105899
580, 680, 780, 880 4-cyl., 880 5-cyl., 980, 80-90, 100-90, 115-90, 130-90, 2-speeds				OAS689010 515891
60-90, 70-90, 80-90, 640 1-speed				OAS508010 5111518
55-90, 60-90, 70-90 2-speeds				OAS558010 5119203
1180, 1380, 1580, 1880, 140-90, 160-90, 180-90 2-speeds				OAS689010 5112290

06.10.2006

**COMPLETE
DIFFERENTIAL GEARS**

T3591

T3591

5117236

- fits: 580, 680 later model, 780,
70-90, 80-90, L75, L85, L95, TL80, TL90

T3335

5117247

- fits: 880 4-cyl., 880 5-cyl., 980, 90-90, 100-90, 110-90

25.07.2008



FT5131916



T3550



T3553

TRACTOR MODEL	REAR AXLE	REAR MAIN OIL SEAL	REAR WHEEL BOLT	REAR WHEEL NUT
312, 315, 411, 415, 450, 500, 550, 600, 640		OAS50689 7106795	T3549	
650, 750			T3550 44011089	T3553 (e) 12164211
850, 1000, 1000 Super				T3553 (e) 12164211
580		FT5123205 5123205	T3550 44011089	T3553 (e) 12164211
680	T3034 5168626	FT5123205 5123205	T3550 44011089	T3553 (e) 12164211
780	T3034 5168626	FT5123205 5123205	T3550 44011089	T3553 (e) 12164211
880-4		FT5123253 5123253	T3550 44011089	T3553 (e) 12164211
880-5		FT5123253 5123253	T3550 44011089	T3553 (e) 12164211
980	T3534 5123257	FT5123259 5123259	T3550 44011089	T3553 (e) 12164211
1180, 1380, 1580	T3535 (a) 5135352		T3552 5102745	T3553 (e) 12164211
55-90, 60-90, 65-90	T3536 5131917	FT5131916 5131916	T3550 44011089	T3553 (e) 12164211
70-90, 80-90	T3034 5168626	FT5123205 5123205	T3550 44011089	T3553 (e) 12164211
90-90		FT5123253 5123253	T3550 44011089	T3553 (e) 12164211
100-90, 110-90	T3534 5123257	FT5123259 5123259	T3550 44011089	T3553 (e) 12164211
115-90			T3552 5102745	T3553 (e) 12164211
130-90, 140-90, 160-90	T3535 (a) 5135352	FT5126465 5126465	T3552 5102745	T3553 (e) 12164211

a - partly see the dimensions on old shaft

	inner bearing ins. dim.	outer bearing ins. dim.	oil seal inside dimension	
	T3535	80	90	130 mm

e - washer for nut T3554

PRESS RIM NUT

FT5100941

5100941

- for Fiat -tractors with press rim center plates



08.05.2009



T3421



T3071



T3070



T3743

TRACTOR MODEL	BRAKE DISC	HAND BRAKE PAD 1-SIDES	HAND BRAKE PAD 2-SIDES	PISTON O-RINGS
640	T3178 (a) 5107958			
580, 680, 780	T3423 (c) 5112630	T3071 5158120	T3070 5158123	T3745 (d) 5105536 T3744 (e) 5105534
880 4-cyl., 880 5-cyl., 980	T3423 (c) 5112630	T3071 5158120	T3070 5158123	T3742 (d) 5169562 T3743 (e) 5169561
1180, 1380, 1580, 1880		T3071 5158120	T3070 5158123	
55-90, 60-90, 70-90, 80-90	T3421 4997208 5184313			T3745 (d) 5105536 T3744 (e) 5105534
90-90, 100-90	T3423 5112630	T3071 5158120	T3070 5158123	T3742 (d) 5169562 T3743 (e) 5169561
115-90, 130-90, 140-90, 160-90, 180-90		T3071 5158120	T3070 5158123	
570, 580, 60-93, 60-94, 65-90, 65-93, 65-94, 670, 680, 72-93, 72-94, 780, 82-93, 82-94, 85-90, 88-93, 88-94, L60, L65, L75, L85, L95	T3421 4997208 5184313			

a - brake band

d - big

e - small



BRAKE STUD VALVE AND SPRING

- 80, 90 and 94-series

T3746
4997674

T3747
4999488



LEVELLING BOX

T3655

4999165
- Fiat 640
(upper picture)

T3739

5125920
- 70-90, 80-90
- adjustment 640-760 mm
- for 24 mm lower link



STABILIZER SUPPORT

T0422

5127401
- 4-cyl. 80, -90, -94-series
- L = 1150 mm

T0408

5127015
- 6-cyl. 80, -90-series
up to 110-90
- L = 1550

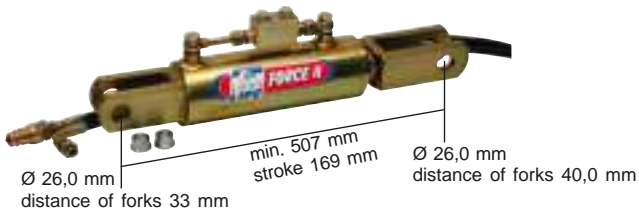

HYDRAULIC LEVELLING BOX

T1720

- 60-90-110-90
- piston 80 mm
- shaft 40 mm
- adapter sleeve 25,9/22,2 mm 2 pcs

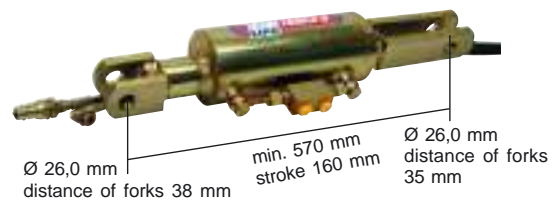

HYDRAULIC LEVELLING BOX

T1722

- New Holland M135
- piston 100 mm
- shaft 50 mm

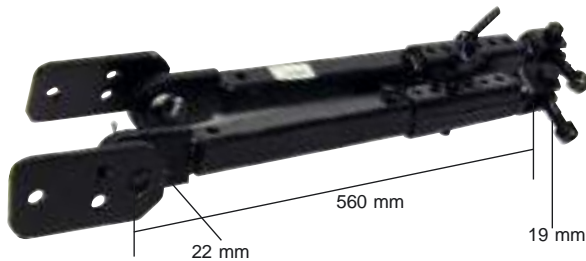

STABILIZER PAIR

T0171

- Fiat 415, 600, 640
- inner pin 30x30 mm
- pin 12 mm

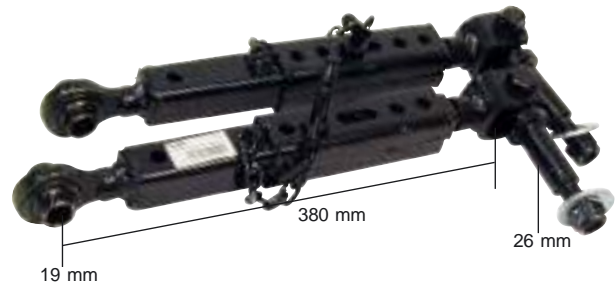

STABILIZER PAIR

T0409

5123273
- Fiat 580, 680, 780
- inner pipe 30x30 mm, pin 12 mm

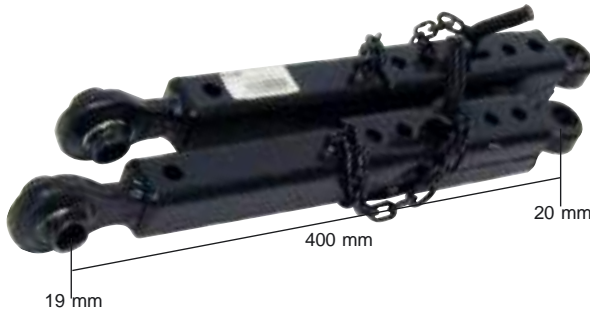

STABILIZER PAIR

T0189

5123273
- Fiat 55-90-110-90
- inner pipe 30x30 mm, pin 12 mm

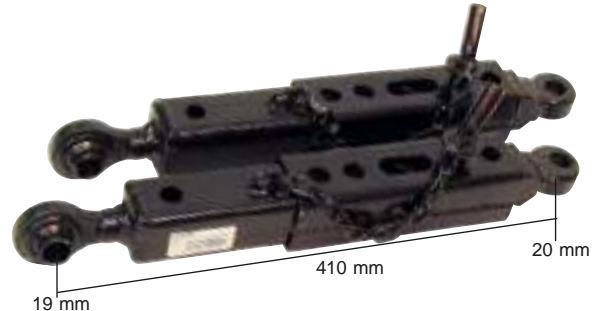

STABILIZER PAIR

T0190

5109518
- Fiat Winner-series
- inner pipe 40x40 mm, pin 16 mm



FIAT, FIATAGRI HYDRAULIC LIFT COMPONENTS



06.10.2006



T3738



T3083



T3048



T3748



T3750



T3677

TRACTOR MODEL	HYDR. LIFT SHAFT	HYDR. LIFT SHAFT BUSH	HYDR. LIFT SHAFT GASKET	LOWER LINK SHAFT	LOWER LINK SEAL
312, 315, 411, 415, 450, 500, 550, 600, 640	T3048 4955425				
580, 680, 780, 80 4-cyl.			T3750 5159078		
580, 680, 780, 880 4-cyl., 880 5-cyl., 980 later model			T3750 5159078	T3548 5111458	
55-90, 60-90, 70-90, 80-90, 65-90		T3748 (a) 5186406 T3749 (b) 5186405	T3750 5159078	T3083 5116243	T3677 5121123
1180, 1380, 1580, 1880, 115-90, 130-90, 140-90, 160-90, 180-90		T3748 (a) 5186406 T3749 (b) 5186405	T3750 5159078		
90-90, 100-90		T3748 (a) 5186406 T3749 (b) 5186405	T3750 5159078	T3548 5111458	

a - right 2 pcs/tractor

b - left 2 pcs/tractor

STABILIZER PIN



T0616

5103862
- thickness 16 mm
- length 62 mm

T0619

5105520
- thickness 19 mm
- length 73 mm

LIFT CYLINDER SEALS



T3731



T3732



T3735



T3736

TRACTOR MODEL	SUPPORT RING	O-RING FRONT	O-RING REAR	SUPPORT RING REAR
640, 550, 580, 680, 780, 880, 980	T3729 4999412	T3732 14472880	T3735 14472380	T3736 5106297
55-90, 60-90, 65-90		T3733 1446568		
70-90, 80-90, 85-90, 90-90, 100-90, 110-90	T3731 5125941	T3734 14465981		

C1.31

25.07.2008



T3452

T3112

T3446, T3448, T3448XL

T3713

TRACTOR MODELS	HYDRAULIC PUMP		POWER STEERING PUMP	HYDR. DRIVE GEAR	CONNECTING BUSH	COUPLING
450	T3452 8273385		T3111 50130133	T3049 4673811	T3089 5118570	T3088 5118569
600, 640	T3112 5129478	T3446 (a) 5129483	T3111 50130133	T3049 4673811	T3089 5118570	T3088 5118569
750	T3112 5129478		T3111 50130133			
850, 1000	T3446 5129483		T3111 50130133	T3443 4747597	T3089 5118570	T3088 5118569
1000, 1300			T3111 50130133	T3443 4747597	T3089 5118570	T3088 5118569
580, 680, 780	T3112 5129478	T3446 (a) 5129483	T3111 50130133	T3049 4673811	T3089 5118570	T3088 5118569
880 4-cyl.	T3112 5129478	T3446 (a) 5129483	T3111 50130133		T3089 5118570	T3088 5118569
880 5-cyl.	T3112 5129478	T3446 (a) 5129483	T3452 8273385 T3453 (b) 98307212	T3443 4747597	T3089 5118570	T3088 5118569
980	T3112 5129478	T3446 (a) 5129483	T3453 (b) 98307212	T3443 4747597	T3089 5118570	T3088 5118569
1180	T3446 5129483		T3453 (b) 98307212	T3443 4747597	T3089 5118570	T3088 5118569
1380	T3448 5129488		T3453 (b) 98307212	T3443 4747597	T3089 5118570	T3088 5118569
1580, 1880	T3448 5129488		T3453 (b) 98307212		T3089 5118570	T3088 5118569
55-90, 60-90, 70-90, 80-90	T3446 5129483	T3448 (a) 5129488	T3454 (b) 5180269 tai T3455 (c, b) 5180273		T3089 5118570	T3088 5118569
90-90, 100-90, 110-90	T3448 5129488	T3448XL (a) 2TK22S	T3454 5180269 tai T3455 (c, b) 5180273		T3089 5118570	T3088 5118569
115-90, 130-90, 140-90	T3448 5129488	T3448XL (a) 2TK22S	T3455 (b) 5180273		T3089 5118570	T3088 5118569
160-90, 180-90	T3448 5129488	T3448XL (a) 2TK22S	T3455 (b) 5180273		T3089 5118570	T3088 5118569
F110, F120	T3713 (d) 5179726		T3714 (e) 5180275			
F130, F140	T3713 (d) 5179726		T3714 (e) 5180275			

a - larger type

b - pump equipped with release valve

c - in later Hi-Lo-models **T3455 (C30XRP)**

d - **T3713 C42**

e - **T3714 A31XRP2**

25.07.2008



TRACTOR MODEL	COMPLETE DRAG LINK	STEERING JOINT (c)	STEERING CYLINDER	OUTER PIN	WASHER	INNER PIN	WASHER
450, 500, 600, 640, 650, 750		T3154 802337					
850, 1000, 1300		T3559 802696					
580, 680, 780	T3561 (b) 5108800	T3154 802337	T3624 5110840	T3621 (e) 4987671	T3627 5100730	T3623 (e) 5142048	T3629 5100731
880 4-cyl., 880 5-cyl., 980		T3559 802696	T3624 5110840	T3621 (e) 4987671	T3627 5100730	T3623 (e) 5142048	T3629 5100731
1180, 1380, 1580, 1880		T5145 802690 T3559 (d) 802696		T3620 (f) 5111572	T3628 5111573	T3622 (f) 5111574	T3628 5111573
55-90, 60-90, 65-90	T3155 5104081	T3154 802337	T3624 5110840	T3621 (e) 4987671	T3627 5100730	T3623 (e) 5142048	T3629 5100731
70-90, 80-90		T5145 802690 T3154 (d) 802337	T3625 5137121	T3620 (f) 5111572	T3628 5111573	T3622 (f) 5111574	T3628 5111573
90-90, 100-90, 110-90		T5145 802690 T3154 (d) 802337	T3625 5137121	T3620 (f) 5111572 T3621 (d) 4987671	T3628 5111573 T3627 (d) 5100730	T3622 (f) 5111574 T3623 (d) 5142048	T3628 5111573 T3629 (d) 5100731
115-90, 130-90, 140-90, 160-90, 180-90		T5145 802690		T3620 (f) 5111572 T3621 (d) 4987671	T3628 5111573 T3627 (d) 5100730	T3622 (f) 5111574 T3623 (d) 5142048	T3628 5111573 T3629 (d) 5100731

a - length 1375 mm

b - length 1380 mm

c - **T3154** thread 19,8 mm, cone 18,2/19,5

T3559 thread 24 mm, cone 18,2/20,5

T5145 thread 23,8 mm, cone 20/22

d - if front axel is originally equipped with two steering cylinders

e - bearing **GE20**, Ø 20 mm

f - bearing **GE25**, Ø 25 mm

25.07.2008

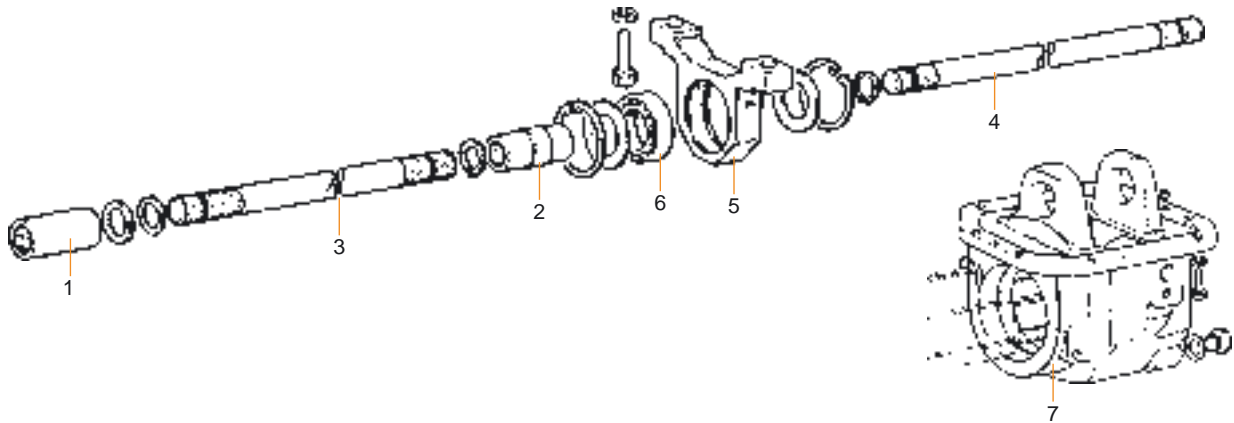

TRACTOR MODEL	1 CARDAN COUPLING FRONT	2 CARDAN COUPLING MIDDLE	3 CARDAN SHAFT FRONT	4 CARDAN SHAFT REAR	5 CARDAN SUPPORT	6 SUPPORT BEARING	7 FWD HOUSING TO GEARBOX
580	T3120 5199243	T3118 4997312			T3068 4997310	L6008-2RS 24905120	
680, 780	T3120 5199243	T3118 4997312	T3119 (a) 5108753		T3068 4997310	L6008-2RS 24905120	
880 4-cyl., 880 5-cyl.	T3323 4994076	T3324 4994075			T3069 4994065	L6009-2RS 24905130	
980	T3323 4994076	T3324 4994075			T3069 4994065	L6009-2RS 24905130	
1180, 1380	T3323 4994076	T3324 4994075			T3069 4994065	L6009-2RS 24905130	
1580, 1880	T3323 4994076	T3324 4994075			T3069 4994065	L6009-2RS 24905130	
55-90, 60-90, 65-90	T3120 5199243	T3118 4997312		T3391 5121352	T3068 4997310	L6008-2RS 24905120	T3639 5169906
70-90, 80-90	T3120 5199243	T3118 4997312	T3392 5121364	T3391 5121352	T3068 4997310	L6008-2RS 24905120	T3639 5169906
90-90	T3323 4994076	T3324 4994075			T3069 4994065	L6009-2RS 24905130	
100-90, 110-90	T3323 4994076	T3324 4994075			T3069 4994065	L6009-2RS 24905130	
90-90, 100-90, 110-90 (quick type)	T3323A (14 splines) 5150124				T3069 4994065	L6009-2RS 24905130	
115-90, 130-90, 140-90	T3323 4994076	T3324 4994075			T3069 4994065	L6009-2RS 24905130	
160-90, 180-90	T3323 4994076	T3324 4994075			T3069 4994065	L6009-2RS 24905130	

a - partly length 850 mm, (from -79)

25.07.2008



TRACTOR MODEL	BUSH		KING PIN TOP/BOTTOM	KING PIN BEARING OILSEAL	KNOCKLE		SHAFT FRONT
	FRONT	REAR			RIGHT	LEFT	
580, 680 (a) 780 later model	T3193 5101112	T3346 5129385	T3652 4997354	L32006 5109555 OAS50627 5122548			
580, 680, 780	T3193 5101112	T3346 5129385	T3189 5121116	LM86649-610 OA56708 5121471			T3586 5131122
880 4-cyl., 880 5-cyl., 980	T3193 5101112	T3346 5129385	T3189 5121116	LM86649-610 OA56708 5121471	T3439 4994186		
1180, 1380, 1580, 1880	T3193 5101112	T3346 5129385	T3188 5120531	L32208 5119660			
55-90, 60-90	T3193 5101112	T3346 5129385					
65-90	T3193 5101112	T3346 5129385					T3715 5126631
70-90, 80-90	T3193 5101112	T3346 5129385	T3189 5121116	LM86649-610 OA56708 5121471	T3597 5126939		T3586 5131122
90-90, 100-90, 110-90	T3193 5101112	T3346 5129385	T3189 5121116	LM86649-610 OA56708 5121471	T3599 5127197	T3598 5127196	
115-90, 130-90, 140-90, 160-90	T3193 5101112	T3346 5129385	T3188 5120531	L32208 5119660			

a - later model = king pin is smaller



FRONT AXLE HYDRAULIC DIFFERENTIAL LOCK

T3585

5142829

- 1380, 1580, 1880, 115-90, 130-90, 140-90, 160-90, 180-90

25.07.2008

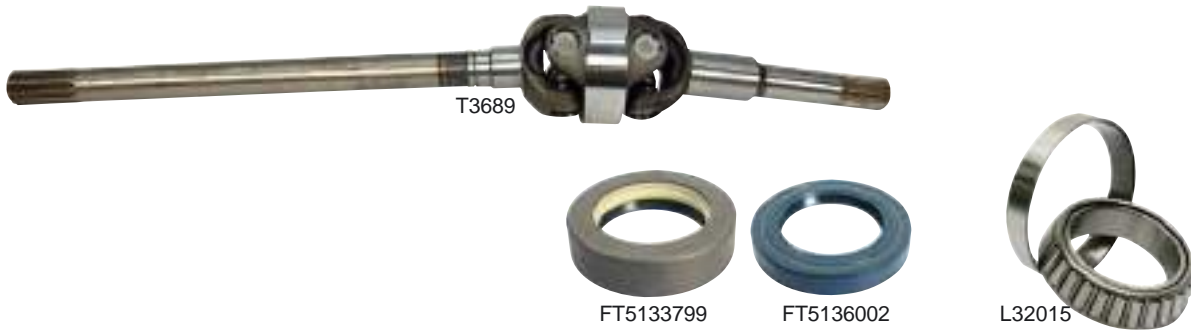

TRACTOR MODEL	FRONT HUB SEAL	OUTER DRIVE SHAFT SEAL	INNER DRIVE SHAFT SEAL	HUB BEARING INNER	HUB BEARING OUTER
580 old, 680 old, 780 old		FT5133799 5133799	FT5116701 5116701		
1300	FT5136003 5136003		FT5136002 5136002	L32015 24903480	L32016 24903490
640, 650	FT5107808 5107808		FT5105948 5105948		
580, 680, 780	FT5136004 5136004	FT5133799 5133799	FT5136002 5136002	L32014 24903470	L32014 24903470
880, 880-5, 980	FT5136003 5136003	FT5135990 5135990	FT5136002 5136002	L32015 24903480	L32016 24903490
1180, 1380, 1580, 1880	FT5107808 5107808		FT5105948 5105948	L32016 24903490	
55-90, 60-90	FT5135387 5135387	FT5116717 5116717	FT5116701 5116701		
65-90			FT5116701 5116701		
70-90, 80-90	FT5136004 5136004	FT5133799 5133799	FT5136002 5136002	L32014 24903470	L32014 24903470
90-90, 100-90	FT5136003 5136003	FT5135990 5135990	FT5136002 5136002	L32015 24903480	L32016 24903490
110-90	FT5137109 5137109	FT5133799 5133799			
115-90, 160-90, 180-90	FT5107808 5107808	FT5135990 5135990	FT5105948 5105948	L32016 24903490	
130-90, 140-90	FT5107808 5107808	FT5135990 5135990	FT5105948 5105948	L32016 5133737	L32018 5133737
F110	FT5137109 5137109				

NOTE! Always check dimensions!

FRONT PINION SEAL



FT5111415

5111415
- 57 x 85 x 12
- fits: 70-90, 80-90, 100-90, 110-90, 115-90, 130-90, 140-90, 160-90, 180-90, F120, F130, F140, M135, M160

FRONT HUB SEAL



FT5133736

5133736
- inner
- 190 x 220 x 21
- fits: 115-90, 130-90, 140-90, 160-90, 180-90, 8360, 8430, 8560, 8630, 8830, M135, M160, TL100, TL80, TL90

25.07.2008

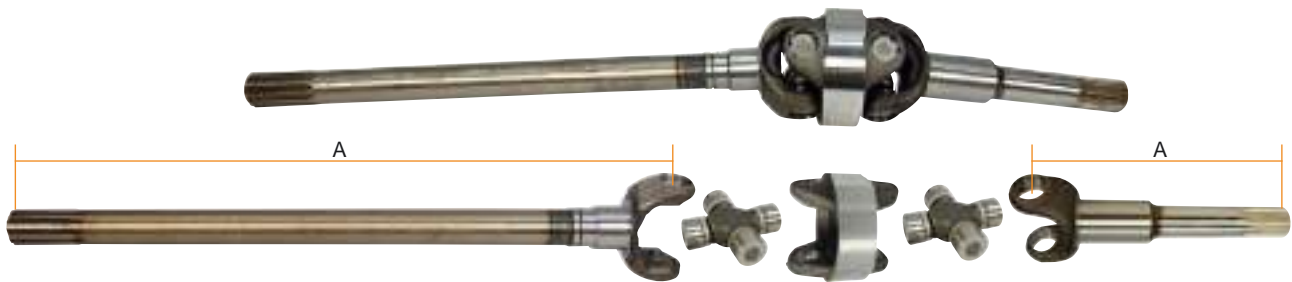

580, 680, 780 (parts fit, complete drive shaft not)
55-90, 60-90, 65-90

		Dim. A	Spli- nes
T3031	9928667	Middle part	
CR277	4552009	Universal joint 27,00 x 74,60 mm	
CR048		Universal joint 27,00 x 74,60 mm with grease nipple	
T3180	9956515	Front wheel drive shaft inner	526 mm 10
T3181	9956516	Front wheel drive shaft inner	580 mm 10
T3386	9928665	Front wheel drive shaft outer	94 mm 15

880, 980
70-90, 80-90, 90-90, 100-90, 110-90
F100, F110, F115, 84-94

		Dim. A	Spli- nes
T3688	5114993	Drive shaft complete right	12/13
T3184	9930899	Middle part	
T3387	9962244	Universal joint 27,00 x 81,70 mm (original) 9962244	
CR392(a)	9923550	Universal joint 27,00 x 81,70 mm	
T3085	9930900	Drive shaft left	607 mm 12
T3086	9930902	Drive shaft right	670 mm 12

580, 680, 780
70-90, 80-90, 90-90, 100-90,
F100, F110, F115, 84-94

		Dim. A	Spli- nes
T3689	5114991	Drive shaft complete left	12/14
T3690	5114989	Drive shaft complete right	12/14
T3184	9930899	Middle part	
T3387		Universal joint 27,00 x 81,70 mm (original) 9962244	
CR392(a)	9923550	Universal joint 27,00 x 81,70 mm	
T3093	9957397	Drive shaft left	531 mm 12
T3094	9957395	Drive shaft right	595 mm 12
T3095	9957396	Front wheel drive shaft outer	242 mm 14

8160, 8260, M100, M115, M160
F100, F115, 90-90, 100-90, 110-90

		Dim. A	Spli- nes
T3184	9930899	Middle part	
T3387	9962244	Universal joint 27,00 x 81,70 mm (original) 9962244	
CR392(a)	9923550	Universal joint 27,00 x 81,70 mm	
T3740	5189163	Drive shaft complete right	12/14
T3741	5164853	Drive shaft complete right	12/14

1180, 1380, 1580, 1880
115-90, 130-90, 140-90, 160-90, 180-90

		Dim. A	Spli- nes
T3644	9959702	Middle part	
CR098	9959701	Universal joint 30,17x92,00 mm	
T3641	9959704	Front wheel drive shaft	640 mm 14
T3642	9959703	Drive joint	249 mm 14

1180, 1380, 1580, 1880
115-90, 130-90, 140-90, 160-90, 180-90

		Dim. A	Spli- nes
T3644	9959702	Middle part	
CR098	9959701	Universal joint 30,17x92,00 mm	
T3645	9959692	Front wheel drive shaft right	696 mm 14

a - no grease nipple in the joint, endures greater load

08.05.2009

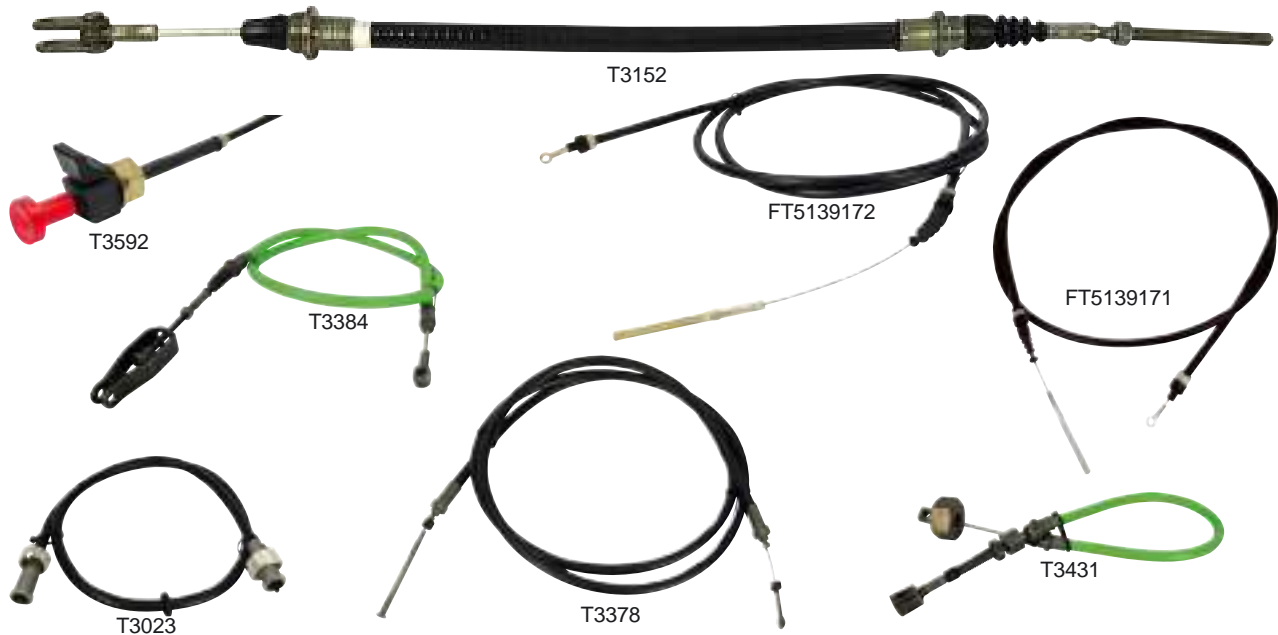

TRACTOR MODEL	PULL TO STOP CABLE	HOUR METER CABLE	HAND THROTTLE CABLE	CONTROL SWITCH CABLE	P.T.O. CLUTCH CABLE	HYDR. LIFT CONTROL CABLE	HAND BRAKE CABLE
640		T3023 4976720					
750, 850		T3325 4976739					
1000		T3331 4976770					
580		T3023 4976720	T3066 5149955	T3065 5115686	T3064 5101694	T3036 4999388	
680	T3592 5153380	T3023 4976720	T3066 5149955	T3065 5115686	T3064 5101694	T3036 4999388	
780	T3592 5153380	T3023 4976720	T3066 5149955	T3065 5115686	T3064 5101694	T3036 4999388	
880 4-cyl.	T3592 5153380	T3325 4976739	T3066 5149955	T3152 5120399	T3126 5101695	T3036 4999388	
880 5-cyl., 980	T3593 5153381	T3023 4976720	T3066 5149955	T3152 5120399	T3126 5101695	T3036 4999388	
1180	T3593 5153381		T3378 5149956				T3431 5111687
1380	T3592 5153380		T3378 5149956				T3431 5111687
1580	T3593 5153381	T3329 5112653	T3378 5149956				T3431 5111687
1880		T3329 5112653	T3378 5149956				T3431 5111687
55-90, 60-90, 70-90, 80-90		T3023 4976720	T3378 5149956	T3152 5120399	T3384 5126567	FT5139172 (a) 5139172	T3430 5125736
90-90		T3023 4976720	T3378 5149956	T3152 5120399	T3385 5131252	FT5139172 (a) 5139172	T3431 5111687
100-90, 110-90		T3023 4976720	T3378 5149956	T3152 5120399	T3385 5131252	FT5139172 (a) 5139172	T3431 5111687
115-90, 130-90, 140-90	T3592 5153380	T3330 4976718	T3378 5149956			FT5139171 5139171	T3431 5111687
160-90	T3593 5153381	T3329 5112653	T3378 5149956			FT5139171 5139171	T3431 5111687
180-90		T3329 5112653	T3378 5149956			FT5139171 5139171	T3431 5111687
8430, 8630, 8830						FT5139171 5139171	

a - FT5139172 hydr. lift control "Clic Clac" -cable

26.10.2007



TRACTOR MODEL	STARTER BOSCH TYPE	STARTER MARELLI TYPE	SOLENOID BOSCH	SOLENOID MARELLI	BENDIX WHEEL BOSCH TYPE	BENDIX WHEEL MARELLI
450, 500		ST0220 4682998		ST0170 9940366		
550, 600	SM2505 0001367028	ST0172 4807375	ST0171 20301070		ST1027	
640	SM2505 0001367028	ST0172 4807375	ST0171 20301070	ST0170 9940366	ST1027	ST0189 9986112
650, 750, 850, 1300		ST0214 4737758				
1000	SM2505 0001367028	ST0172 4807375	ST0171 20301070	ST0170 9940366	ST1027	ST0189 9986112
880 4-cyl.		ST0214 4737758	ST0171 20301070	ST0170 9940366		ST0189 9986112
680, 780, 880-5, 980, 1180	SM2505 0001367028	ST0172 4807375	ST0171 20301070	ST0170 9940366	ST1027	ST0189 9986112
880-5, 980, 1180, 1380, 1580	SM2537 0001367029	ST0201 4807376	ST0171 20301070	ST0170 9940366		ST0189 9986112
1880	SM2537 0001367029	ST0201 4807376		ST0170 9940366		ST0189 9986112
580, 55-90, 60-90		ST0220 4682998	ST0171 20301070	ST0170 9940366		ST0189 9986112 ST0199 4808498
70-90, 80-90, 82-94 65-90, 85-90, 88-94	SM2505 0001367028	ST0172 4807375		ST0170 9940366	ST1027	ST0189 9986112
90-90, 100-90, 115-90	SM2537 0001367029	ST0201 4807376		ST0170 9940366		ST0189 9986112
130-90, 140-90, 110-90 160-90, 180-90	SM2537 0001367029	ST0201 4807376		ST0170 9940366		ST0189 9986112
NEW HOLLAND M-series	ST0235 82005342					
L65, L75, L85, L95	SM2505 0001367028	ST0172 4807375		ST0170 9940366	ST1027	ST0189 9986112

ALTERNATORS



ST0169

4746400
- 55 Ah
- 640, 580-1580
(55-90, 60-90 partly)



ST0198

4222697
- 42 Ah
- 650, 750, 850, 1000, 1300



ST0199

4808498
- 65 Ah
- with w-connector
- 65-90, 70-90, 80-90,
90-90, 82-94, 88-94
(55-90, 60-90 partly)



ST0200

4808517
- 65 Ah
- with w-connector
- 90-90, 100-90, 115-90,
130-90, 140-90, 110-90



STARTER SWITCH

T3514

4158641, 5118483
- 450, 500, 550, 600, 640, 650, 750, 850, 1000, 1300



STARTER SWITCH

T3190

4998108, 5112124, 5122727
- 580, 680, 780, 880, 980, 1180, 1380, 1580, 1880, 60-90, 65-90, 65-94, 70-56, 70-66, 70-90, 80-66, 80-90, 82-93, 82-94, 85-90, 88-94, 90-90, 100-90, 110-90, 115-90, 130-90, 140-90, 160-90, 180-90



STARTER SWITCH

T3755

5154401
- 23/950-30
- F100, F110, F115, F120, F130, F140, L60, L65, L75, L85, L95



LIGHT SWITCH

T3582

4998107, 5125958
- 580, 680, 780, 880-4, 880-5, 980, 1180, 1380, 1580, 1880



LIGHT SWITCH

T3705

5126126
- 55-90, 60-90, 65-90, 70-90, 80-90, 85-90, 90-90, 100-90, 115-90, 130-90, 140-90, 160-90, 180-90



GLOW SWITCH

T3707

5176282
- 55-90, 60-90, 65-90, 70-90, 80-90, 85-90, 90-90, 100-90, 115-90, 130-90, 140-90, 160-90, 180-90



WORK LIGHT SWITCH

T3706

9957649
- 55-90, 60-90, 65-90, 70-90, 80-90, 85-90, 90-90, 100-90, 115-90, 130-90, 140-90, 160-90, 180-90



MULTI-PURPOSE SWITCH LEFT

T3967

5126127
- 115-90, 130-90, 140-90, 160-90, 180-90



MULTI-PURPOSE SWITCH RIGHT

T3698

5129345
- 55-90, 60-90, 65-90, 70-90, 80-90, 85-90, 90-90, 100-90, 110-90

Note!

For more blinker relays see Accessories catalogue section 2



BLINKER RELAY

ST0260

5125586
- universal model

25.07.2008



FRONT LIGHT

T3617

5137933
- rounded, complete
- fits 580-1880



FRONT LIGHT

5138349
- rectangle, complete
- fits 580-1880,
55-90 - 180-90



FRONT SIDE LIGHT RIGHT

F0658

5146291
- fits: L60, 65, 75, 85, 95
M100, 115, 135, 160
TM115, 120, 125, 130, 135,
140, 150, 155, 165, 175,
190, TS90, 100, 110, 115

FRONT SIDE LIGHT LEFT

F0659

5146292
- fits: L60, 65, 75, 85, 95
M100, 115, 135, 160
TM115, 120, 125, 130, 135,
140, 150, 155, 165, 175,
190, TS90, 100, 110, 115



REAR LIGHT LEFT

T3046

4997266
- pininfarina, cabina larga, 100-90, 110-90, 115-90, 1180,
1280, 130-90, 1380, 140-90, 1580, 160-90, 1880, 446,
45-66, 466, 50-66, 55-66, 55-90, 566, 580, 60-66, 60-90,
60-93, 60-94, 65-66, 65-90, 65-93, 65-94, 666, 680, 70-66,
70-90, 72-93, 72-94, 766, 780, 80-66, 80-90, 82-93, 82-94,
85-90, 880, 880-5, 88-93, 88-94, 90-90, 980
- spare glass T3044



REAR LIGHT RIGHT

T3047

4997267
- pininfarina, cabina larga, 100-90, 110-90, 115-90, 1180,
1280, 130-90, 1380, 140-90, 1580, 160-90, 1880, 446,
45-66, 466, 50-66, 55-66, 55-90, 566, 580, 60-66, 60-90,
60-93, 60-94, 65-66, 65-90, 65-93, 65-94, 666, 680, 70-66,
70-90, 72-93, 72-94, 766, 780, 80-66, 80-90, 82-93, 82-94,
85-90, 880, 880-5, 88-93, 88-94, 90-90, 980
- spare glass T3045



REAR LIGHT

F0660

82008066
- fits: L60, 65, 75, 85, 95



FRONT LIGHT

- pininfarina cabin, 100-90, 110-90, 115-90, 1180, 1280, 130-90, 1380, 140-90, 1580,
160-90, 1880, 446, 45-66, 466, 50-66, 55-66, 55-90, 566, 580, 60-66, 60-90, 60-93, 60-94,
65-66, 65-90, 65-93, 65-94, 666, 680, 70-66, 70-90, 72-93, 72-94, 766, 780, 80-66, 80-90,
82-93, 82-94, 85-90, 880, 880-5, 88-93, 88-94, 90-90, 980

Left

T3041

4999858
- spare glass left T3042

Right

T3040

4999859
- spare glass left T3043

FRONT LIGHT

- cabina larga cabin

Left

T3579

5116239
- spare glass right/left T3581



Right

T3580

5116238



HEAD LAMP

F0657

5112013
- fits:
L60, 65, 75, 85, 95
TL70, 80, 90, 100



FUSE BOX

T3753

4998859
- fits: 90, 94 series
- for 12 fuses

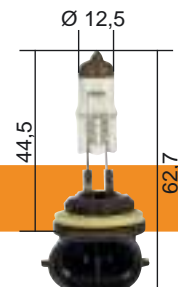

BULB

P12886

8200449
- for work light New Holland M-series
- 12,8V, 50W
- base PGJ13

08.05.2009



DOOR LOCK AND INNER HANDLE

- 580-1880, 55-90 - 180-90
- all models with "Pininfarina" cabin

Left
T3080

5108380

Right
T3081

5108381



HANDLE ASSEMBLY OUTER

- 580-1880, 55-90 - 180-90
- all models with "Pininfarina" cabin

Left
T3076

5108382

Right
T3077

5108392



DOOR STOP

Spring

FT5108410

5108410

- 80-series

Cable

FT5120144

5120144

- 90-94 series

Spring

FT5120172

5120172

- 90-94 series

CABIN RUBBER PAD



T3090

4997423

- 100-90, 110-90, 4635, 4835, 55-88, 55-90, 5635, 60-88, 60-90, 60-93, 60-94, 65-88, 65-90, 65-93, 65-94, 6635, 70-80, 70-90, 72-93, 72-94, 7635, 80-88, 80-90, 82-93, 82-94, 85-90, 88-93, 88-94, 90-90, L60, L65, L75, L85, L95, TL100, TL70, TL80, TL90



GEAR DRIVE FOR HOUR METER

T3752

598816, 5109356

- 466, 566, 580, 666, 680, 780, 880, 980, 35-66, 45-66, 50-66, 55-46, 55-66, 55-88, 55-90, 60-46, 60-66, 60-76, 60-86, 60-90, 60-93, 60-94, 65-46, 65-56, 65-66, 65-88, 65-90, 65-93, 65-94, 70-56, 70-66, 70-88, 72-86, 72-93, 72-94, 80-66, 80-76, 80-88, 80-90, 82-86, 82-93, 82-94, 85-90, 88-93, 88-94, 90-90, 100-90, 110-90, 115-90, 130-90, 140-90, F100, F110, F115, F120, F130, F140, L60, L65, L75, L85, L95



FRONT GRILL

T3060

5175979

- for rectangle light
- painted
- fits 580-980, 55-90 - 100-90



HEATER FAN MOTOR

T3565

- 580-1880, 55-90 - 180-90
- all models with "Pininfarina" cabin
- resistor **T3565A**



HEATER FAN MOTOR

F0654

82034854
- fits: M100, 115, 135, 160
TM115, 120, 125, 130, 140

HEATHER TAP

T3751

9961515
- 90-94-series



25.07.2008



MIRROR WITH ARM

- 80 and 90 -series
- includes fastening piece

Left

T3634

5108722

Right

T3633

5108721

Mirror

T1527

5126233



SUN ROOF HANDLE

T3082

5178614

- 580-1880, 55-90 - 180-90
- all models with "Pininfarina" cabin



MIRROR

F0599

82014840

- NH 60 and M series, TM175, 190, TS110, 115, 125A, 130A, 135A
- spare mirror F0601

MIRROR ARM

Left

F0595

82014839

Right

F0596

82014838



MIRROR

F0600

82014587

- NH 60-, -70, M, TM- and TS-series
- spare mirror T2420

TELESCOPIC MIRROR ARM

Left

F0597

82014589

Right

F0598

82014588

REAR GLASS HANDLE

T3708

5113656, 5178432

- 580-1880, 55-90 - 180-90
- partly models with "Pininfarina" cabin



REAR GLASS HINGE

T3079

5122998

- 580-1880, 55-90 - 180-90
- all models with "Pininfarina" cabin



WIPER BLADE

VLC3228

5139806

- fits: 580, 680, 780, 880, 880-5, 980 pininfarina
- 1180, 1380 pininfarina, 1580, 1880 (pininfarina)
- Fiatagri 55-90, 60-90, 65-90, 70-90, 80-90 narrow cabin
- Fiatagri 70-, 80-, 85-, 90-, 100-, 110-, 115-, 130-, 140-, 160-, 180-90 CL-cabins



WIPER BLADE

VLC3225

5144385

- fits: Winner F100, F110, F120, F130, F140

25.07.2008



TRACTOR MODEL	REAR WINDOW STRUT	ROOF WINDOW STRUT	DOOR STRUT
580, 680, 780, 880, 880-5, 980 pininfarina	T3078 KS0113 5129427	T3619 KS0114 5125289	
1180, 1380 pininfarina	T3078 KS0113 5129427	T3619 KS0114 5125289	
1580, 1880 (pininfarina)	T3078 KS0113 5129427	T3619 KS0114 5125289	
Fiat-agri 55-90, 60-90, 65-90, 70-90, 80-90 narrow cabin	T3078 KS0113 5129427	T3619 KS0114 5125289	
Fiat-agri 70-, 80-, 85-, 90-, 100-, 110-, 115-, 130-, 140-, 160-, 180-90 CL-cabins	T3078 KS0113 5129427	T3619 KS0114 5125289	
Winner F100, F110, F120, F130, F140	KS0143 5153193	KS0144 5153206	VPM1689 KS0142 5147419

08.05.2009



Fiatagri CS2 & CS2/1-cabins (Pininfarina)

580, 680, 780, 880, 980, 55-90 - 80-90

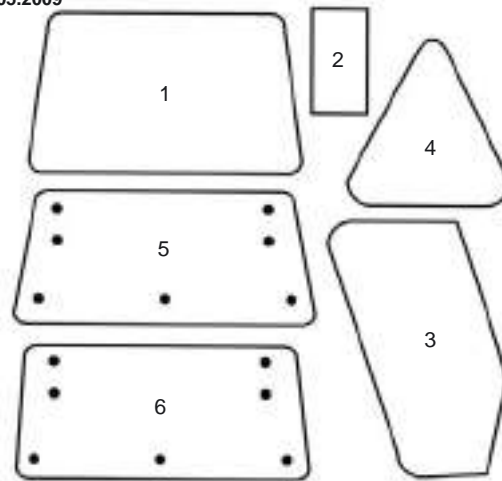

ORDER NUMBER	WINDOW	DESCRIPTION	ORIGINAL PART NUMBER	SIZE mm (H x W x thickness)	TINT	FIXING
1	T3760 (d)	windscreen	5108663	1100 x 660 x 6	clear	GR
2	T3761 (d)	lower front	5108667	584 x 211 x 5	clear	GR
3	T3657	door	5108670/5108669	1165 x 565 x 4	clear	GR
4	T3762	side window	5108673	601 x 484 x 4	clear	GR
4	T3763	side window	5108674	601 x 484 x 4	clear	GR
5	T3583 (b)	upper rear	5108627	1088 x 600 x 6	clear	K/BLT
6	T3764 (a, c)	upper rear	5121385	1063 x 597 x 6	clear	K/BLT

- a - replaces number 5113393
- b - up to serial number →9000
- c - from serial number 9001→
- d - 55-90 - 80-90 with Pininfarina cabin

Models above suit also for the following CS-cabin types, with the difference of tinted colour:

- 1 & 2 for cabin types CS8, 11 & 15
- 3 for cabin types CS5, 6, 8 & 9
- 4 for cabin types CS8
- 6 for cabin types CS8 & 15

Fiatagri CS3-cabins

1180, 1280, 1380, 1580, 1880

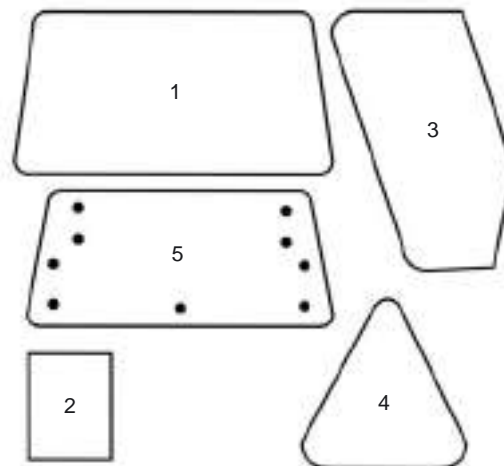

ORDER NUMBER	WINDOW	DESCRIPTION	ORIGINAL PART NUMBER	SIZE mm (H x W x thickness)	TINT	FIXING
1	T3765	windscreen	5113401	1405 x 660 x 6	clear	GR
2	T3766	lower front	5113402	584 x 364 x 5	clear	GR
3	T3657	door	5108670/5108669	1165 x 565 x 4	clear	GR
4	T3762	side window	5108673	601 x 484 x 4	clear	GR
4	T3763	side window	5108674	601 x 484 x 4	clear	GR
5	T3767	upper rear	5113403	1367 x 595 x 6	clear	K/BLT

Models above suit also for the following CS-cabin types, with the difference of tinted colour:

- 1 & 2 for cabing types CS5, 6 & 9
- 3 for cabing types CS5, 6, 7, 8 & 9
- 4 for cabing type CS8
- 5 for cabing types CS5, 6 & 9

Fixing: B = bonded
BLT = bolt on
F = framed
GR = glazing rubber
K = knock on rubber

C1.45

12.01.2009



Fiatagri CL-cabins

70-90, 80-90, 90-90,
100-90, 115-90, 180-90

Models above suit also for the following
CL-cabin types with the difference
of colour:

- 1 & 2 for cabin types CS5, 6 & 9
- 3 & 4 for cabin types CS15

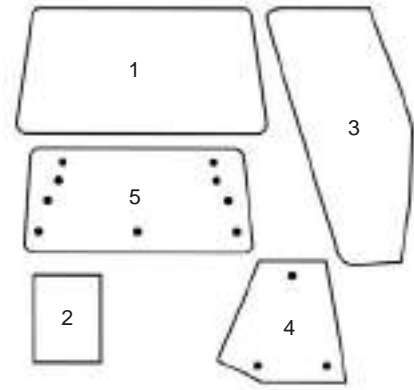

	ORDER NUMBER	WINDOW	DESCRIPTION	ORIGINAL PART NUMBER	SIZE mm (H x W x thickness)	TINT	FIXING
1	T3765	windscreen		5113401	1405 x 660 x 6	clear	GR
2	T3766	lower front	left & right	5113402	584 x 364 x 5	clear	GR
3	T3658	door	left & right, curved	5130884/5130883	1355 x 540 x 4	tinted	GR
4	T3768 (a)	side window	left & right, 3 holes	5165571	598 x 555 x 4	tinted	K/BLT
5	T3584	upper rear	9 holes	5130388	1367 x 595 x 6	clear	K/BLT

a - replaces numbers 5130773 & 5130895

Fiat Winner

REAR WINDOW

T3701

5154756

- Fiat Winner F100, F110, F120, F130, F140

DOOR WINDOW

T3702

5154934

- Fiat Winner F100, F110, F120, F130, F140



L-series

60, 65, 75, 85, 95

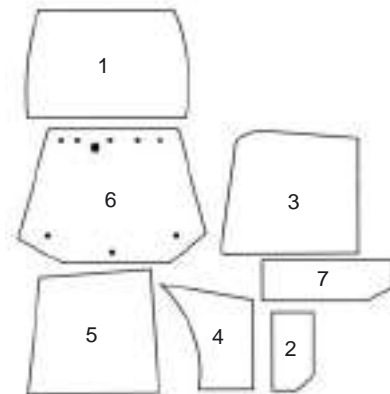

	ORDER NUMBER	WINDOW	DESCRIPTION	ORIGINAL PART NUMBER	SIZE mm (H x W x thickness)	TINT	FIXING
1	F0635	windscreen	fixed, curved	82002183	1154 x 827 x 5	tinted	B
2	F0636	lower front	right	82002184	652 x 340 x 5	tinted	B
2	F0637	lower front	left	82002185	652 x 340 x 5	tinted	B
3	F0638	upper door	right, curved	82002179	870 x 782 x 5	tinted	B
3	F0639	upper door	left, curved	82002180	870 x 782 x 5	tinted	B
4	F0640	lower door	right	82002181	787 x 630 x 5	tinted	B
4	F0641	lower door	left	82002182	787 x 630 x 5	tinted	B
5	F0642	side window	right, curved	82002229	780 x 652 x 5	tinted	B
5	F0643	side window	left, curved	82002230	780 x 652 x 5	tinted	B
6	F82005316 (a)	upper rear	9 holes	5178304	1503 x 905 x 5	tinted	K/BLT
7	F0644	lower rear		82000485	703 x 299 x 5	tinted	B

a - replaces number 82005316

Fixing: B = bonded
BLT = bolt on

F = framed
GR = glazing rubber
K = knock on rubber

C1.46

TL-series

70, 80, 90, 100

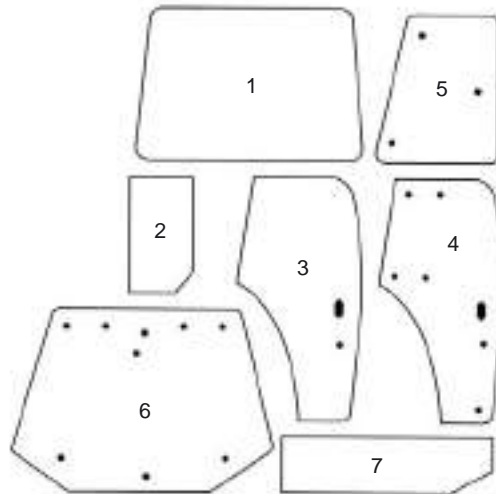

	ORDER NUMBER	WINDOW	DESCRIPTION	ORIGINAL PART NUMBER	SIZE mm (H x W x thickness)	TINT	FIXING
1	F0635	windscreen	curved	82002183	1154 x 827 x 5	tinted	B
2	F0636	lower front	right	82002184	652 x 340 x 5	tinted	B
2	F0637	lower front	left	82002185	652 x 340 x 5	tinted	B
3	F0630 (a)	door	left, 2 holes, curved	82000396	1492 x 842 x 5	tinted	B
3	F0631 (a)	door	right, 2 holes, curved	82000367	1492 x 842 x 5	tinted	B
4	F0604 (b)	door	right, 7 holes, curved	82019225	1560 x 875 x 5	tinted	BLT
4	F0603 (b)	door	left, 7 holes, curved	82019226	1560 x 875 x 5	tinted	BLT
5	F0648	side window	left, 3 holes, curved	5182189	725 x 637 x 5	tinted	BLT
5	F0649	side window	right, 3 holes, curved	5182188	725 x 637 x 5	tinted	BLT
6	F82005316 (c)	upper rear	9 holes	5178304	1503 x 905 x 5	tinted	K/BLT
7	F0644	lower rear		82000485	703 x 299 x 5	tinted	B

a - door with frame b - without frame c - 11/95 → distance of bottom holes 1077 mm

TM-series

115, 125, 135, 150, 165

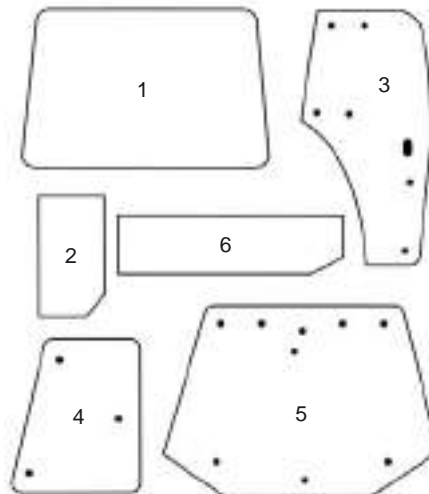

	ORDER NUMBER	WINDOW	DESCRIPTION	ORIGINAL PART NUMBER	SIZE mm (H x W x thickness)	TINT	FIXING
1	F0645	windscreen	curved	82000296	1154 x 840 x 5	tinted	B
2	F0646	lower front	right	82001924	652 x 340 x 6	tinted	B
2	F0647	lower front	left	82001923	652 x 340 x 6	tinted	B
3	F0604	door	right, 7 holes, curved	82019225	1560 x 875 x 5	tinted	BLT
3	F0603	door	left, 7 holes, curved	82019226	1560 x 875 x 5	tinted	BLT
4	F0632	side window	left, 3 holes, curved	82009813	775 x 650 x 5	tinted	BLT
4	F0633	side window	right, 3 holes, curved	82009812	775 x 650 x 5	tinted	BLT
5	F82005316	upper rear	9 holes	82014988	1503 x 905 x 5	tinted	K/BLT
6	F0644	lower rear		82000485	703 x 299 x 5	tinted	B

Fixing: B = bonded BLT = bolt on F = framed

GR = glazing rubber

K = knock on rubber

C1.47

08.01.2007

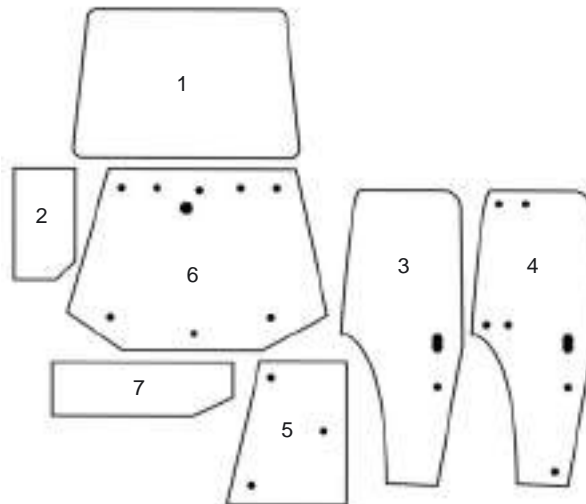

Fiatagri M-series

100, 115, 135, 160

	ORDER NUMBER	WINDOW	DESCRIPTION	ORIGINAL PART NUMBER	SIZE mm (H x W x thickness)	TINT	FIXING
1	F0645	windscreen	fixed, curved	82000296	1154 x 840 x 5	tinted	B
2	F0646	lower front	right	82001924	652 x 340 x 6	tinted	B
2	F0647	lower front	left	82001923	652 x 340 x 5	tinted	B
3	F0630 (d)	door	right, 2 holes, curved	82000396	1492 x 842 x 5	tinted	B
3	F0631 (d)	door	right, 2 holes, curved	82000367	1492 x 842 x 5	tinted	B
4	F0604	door	right, 7 holes, curved	82019225	1560 x 875 x 5	tinted	BLT
4	F0603	door	left, 7 holes, curved	82019226	1560 x 875 x 5	tinted	BLT
5	F0632 (a)	side window	right, 3 holes, curved	82009813	775 x 650 x 5	tinted	BLT
5	F0633 (b)	side window	left, 3 holes, curved	82009812	775 x 650 x 5	tinted	BLT
6	F82005316 (c,e)	upper rear	9 holes	5178304	1503 x 905 x 5	tinted	K/BLT
7	F0644	lower rear		82000485	703 x 299 x 5	tinted	B

- a - replaces number 83995322
- b - replaces number 83995321
- c - replaces number 82005316
- d - with frame not imported to Finland
- e - 11/95 → distance of bottom holes 1077 mm

- Fixing:
- B = bonded
 - BLT = bolt on
 - F = framed
 - GR = glazing rubber
 - K = knock on rubber

WINDSCREEN GLUE SET

HK269

- dispensed cold, non-drip
- max. sticking time 25 min
- ready for driving in 2 hours
- set includes: cleaning agent 20 ml, cleaning linen, primer 10 ml, primer-spreader, glue 310 ml



25.07.2008

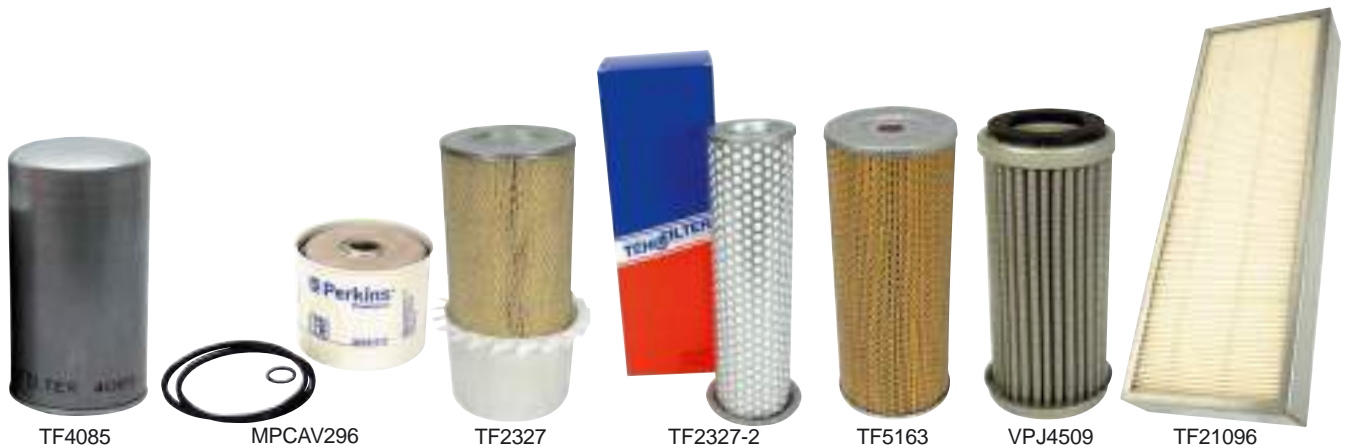

TRACTOR MODEL	OIL FILTER	FUEL FILTER	AIR FILTER OUTER	AIR FILTER INNER	HYDRAULIC FILTER	STEERING FILTER	CABIN FILTER
18		TF7077 1909112					
25R, 215	TF5006 1909104	TF7077 1909112					
211, 311, 312 411, 441	TF5006 1909104	TF7022 (x1) 1909108 TF7077 (x1) 1909112					
250, 300	TF4076 FT1909102 1909102	TFCAV296 MPCAV296 1909100					
315	1909110	TF7077 1909112					
415	TF5006 1909104	TF7022 (x1) 1909108 TF8018 (x1) 1909113					
450, 500, 550, 600, 640	TF4085 1909101	TFCAV296 (x2) MPCAV296 (x2) 1909100					
513R, 615	TF5041 1909123						
650, 750, 850	TF4085 1909101	TF6099 1909103					
1000, 1000S	TF4076 (x2) FT1909102 1909102	TFCAV296 (x2) MPCAV296 (x2) 1909100					
1300, 1300S	TF4085 (x2) 1909101	TF6099 1909103 FT1909107 1909107					
480	TF4085 1909101	TFCAV296 (x2) MPCAV296 (x2) 1909100					
580, 680, 780, 880	TF4085 1909101	TFCAV296 (x2) MPCAV296 (x2) 1909100	TF2327 1909116	TF2327-2 1909117	TF5163 1909106	VPJ4509 (h) 1909143	TF21096 (x2) 1930782 TF21124 (m)
880/5, 980	TF4076 (x2) FT1909102 1909102	TFCAV296 (x2) MPCAV296 (x2) 1909100 TF6206 (x2) 1930010	TF2327 1909116	TF2327-2 1909117	TF5163 1909106	VPJ4509 (h) 1909143	TF21096 (x2) 1930782

See remarks on page C1.52



FIAT, FIATAGRI, NEW HOLLAND FILTERS



25.07.2008



TF4085



MPCAV296



TF2327



TF2327-2



FT1930910



VPJ4509



TF21096

TRACTOR MODEL	OIL FILTER	FUEL FILTER	AIR FILTER OUTER	AIR FILTER INNER	HYDRAULIC FILTER	STEERING FILTER	CABIN FILTER
1180, 1380	TF4076 (x2) FT1909102 1909102	TFCAV296 (x2) MPCAV296 (x2) 1909100 TF6206 (x2) 1930010	TF2113 1909136	TF2113-2 1930175	TF4159 1909130	VPJ4509 (h) 1909143	TF21096 (x2) 1930782
1580, 1880	TF4117 1930544	TF6099 (x1) 1909103 FT1909107 (x1) 1909107	TF2113 1909136	TF2113-2 1930175	TF4159 (x2) 1909130	VPJ4509 (h) 1909143	TF21096 (x2) 1930782
55-90, 60-90 65-90	TF4085 1909101	TFCAV296 (x2) MPCAV296 (x2) 1909100 FT1930581 (a) 1930581	TF2342 1930138	TF2327-2 1909117	TF4159 1909130	VPJ4509 (h) 1909143	TF21096 (b) 1930782 FT5141540 (c) 5141540
70-90, 80-90	TF4085 1909101	TFCAV296 (x2) MPCAV296 (x2) 1909100 FT1930581 (a) 1930581	TF2342 (d) 1930138 TF2327 1909116	TF2327-2 1909117	TF4159 (x2) 1909130	VPJ4509 (h) 1909143	TF21096 (b) 1930782 FT5141540 (c) 5141540
85-90	TF4076 FT1909102 1909102	TFCAV296 (x2) MPCAV296 (x2) 1909100 FT1930581 (a) 1930581	TF2327 (f) 1930116 TF2701 (g) 1930589	TF2327-2 (f) 1930117 TF2677-2 (g) 1930590	TF4159 1909130	VPJ4509 (h) 1909143	FT5141540 (x2) 5141540
90-90	TF4076 (x2) FT1909102 1909102	TF6206 (x2) 1930010 FT1930581 (a) 1930581	TF2342 (d) 1930138 TF2327 1909116	TF2327-2 1909117	TF4159 1909130	VPJ4509 (h) 1909143	TF21096 (b) 1930782 FT5141540 (c) 5141540
100-90, 110-90	TF4076 (x2) FT1909102 1909102	TF6206 (x2) 1930010 FT1930581 (a) 1930581	TF2342 (d) 1930138 TF2327 1909116	TF2327-2 1909117	TF4159 1909130	VPJ4509 (h) 1909143	TF21096 (b) 1930782 FT5141540 (c) 5141540
115-90	TF4076 (x2) FT1909102 1909102	TFCAV296 (x2) MPCAV296 (x2) 1909100 FT1930581 (a) 1930581	TF2332 1930174	TF2113-2 1930175	TF4159 1909130	VPJ4509 (h) 1909143	TF21096 (b) 1930782 FT5141540 (c) 5141540
130-90, 140-90	TF4178 1930213	TFCAV296 MPCAV296 (x2) 1909100 FT1930581 (a) 1930581	TF2332 1930174	TF2113-2 1930175	TF4159 1909130	VPJ4509 (h) 1909143	TF21096 (b) 1930782 FT5141540 (c) 5141540
160-90, 180-90	TF4117 1930544	TF6099 (x1) 1909103 FT1909107 (x1) 1909107 FT1930581 (a) 1930581	TF2332 1930174	TF2113-2 1930175	TF4159 (x3) 1909130 FT1930910 1930910	VPJ4509 (h) 1909143	TF21096 (b) 1930782 FT5141540 (c) 5141540

See remarks on page C1.52

C1.50



FIAT, FIATAGRI, NEW HOLLAND FILTERS



25.07.2008



TRACTOR MODEL	OIL FILTER	FUEL FILTER	AIR FILTER OUTER	AIR FILTER INNER	HYDRAULIC FILTER	STEERING FILTER	CABIN FILTER
65-94, 82-94	TF4085 1909101	TFCV296 (x2) MPCAV296 (x2) 1909100 FT1930581 (a) 1930581	TF2593 1930587	DFP775300 1930588	TF4159 1909130		FT5141540 (x2) 5141540
88-94	TF4076 FT1909102 1909102	TFCV296 (x2) MPCAV296 (x2) 1909100 TF6206 1930010 FT1930581 (a) 1930581	TF2701 1930589	TF2677-2 1930590	TF4159 1909130		FT5141540 (x2) 5141540
F100, F110, F115 F120	TF4076 (x2) FT1909102 1909102	TF6206 (x2) 1930010 FT1930581 (a) 1930581	TF2701 1930589 FT1930605 (e) 1930605	TF2677-2 1930590 TF2327-2 (e) 1930825	FT1930882 1930882		TF21131 (x2) 5124932
F130, F140	TF4178 (x2) 1930213	TF6206 (x2) 1930010 FT1930581 (a) 1930581	TF21101 1930603	TF21101-1 1930790	FT1930882 1930882		TF21131 (x2) 5124932
L60	TF4085 1909101	TF6206 1930010 FT1930581 (a) 1930581	TF2593 (g) 1930587	DFP775300 (g) 1930588	FT1930986 1930986	VPJ4509 (h) 1909143	TF21182 (x2) 82012057 F83994694 (i) 83994694
L65, L75	TF4076 FT1909102 1909102	TF6206 1930010 FT1930581 (a) 1930581	TF2593 (g) 1930587	DFP775300 (g) 1930588	FT1930986 (x2) 1930986	VPJ4509 (h) 1909143	TF21182 (x2) 82012057 F83994694 (i) 83994694
L85, L95	TF4076 FT1909102 1909102	TF6206 1930010 FT1930581 (a) 1930581	FT1930605 (f) 1930605 TF2701 (g) 1930589	TF2327-2 (f) 1930825 TF2677-2 (g) 1930590	FT1930986 (x2) 1930986	VPJ4509 (h) 1909143	TF21182 (x2) 82012057 F83994694 (i) 83994694
M100, M115	TF4015 81879134	F87840591 87840591 F87801341 (j) 87801341 F87840590 (k) 87840590	TF2567 82008600	VPD7112 82008601	DFP502224 82005016 F81863799 81863799		TF21182 (x2) 82012057 F83994694 (i) 83994694
M135, M160	TF4015 81879134	F87840591 87840591 F87801341 (j) 87801341 F87840590 (k) 87840590	F82008606 82008606	F82008607 82008607	DFP502224 82005016 F81863799 81863799		TF21182 (x2) 82012057 F83994694 (i) 83994694

See remarks on page C1.52

C1.51

Original manufacturers names and part numbers are quoted for reference purpose only and are not intended to infer that our replacement parts are used as original equipment.
Tables contain partly reference pictures.



FIAT, FIATAGRI, NEW HOLLAND FILTERS



08.05.2009



TF6206



FT1930605



TF2327-2



FT1930986



VPJ4509



F83994694

TRACTOR MODEL	OIL FILTER	FUEL FILTER	AIR FILTER OUTER	AIR FILTER INNER	HYDRAULIC FILTER	STEERING FILTER	CABIN FILTER
TL70, TL80	TF4076 FT1909102 1909102	TF6206 1930010 FT1930581 (a) 1930581	TF2593 (g) 1930587	DFP775300 (g) 1930588	FT1930986 (x3) 1930986	VPJ4509 (h) 1909143	TF21182 (x2) 82012057 F83994694 (i) 83994694
TL90	TF4076 FT1909102 1909102	TF6206 1930010 FT1930581 (a) 1930581	TF2701 (g) 1930589 FT1930605 (f) 1930605	TF2677-2 (g) 1930590 TF2327-2 (f) 1930825	FT1930986 (x3) 1930986	VPJ4509 (h) 1909143	TF21182 (x2) 82012057 F83994694 (i) 83994694
TL100	TF4076 FT1909102 1909102	TF6206 1930010 FT1930581 (a) 1930581	TF2701 (g) 1930589 FT1930605 (f) 1930605	TF2677-2 (g) 1930590 TF2327-2 (f) 1930825	FT1930986 (x2) 1930986	VPJ4509 (h) 1909143	TF21182 (x2) 82012057 F83994694 (i) 83994694
G170, G190, G210, G240	TF4015 81879134						

a - water trap filter

b - 2 pcs/tractor up to -88

c - 2 pcs/tractor from -88, plastic pin locking

d - conic end, suction pipe from the end of the box

e - with self-cleaning airfilter box

f - with steel airfilter box

g - with plastic airfilter box

h - tank suction filter

i - thin slip-on filter

j - later model of fuel pump on filter foot

k - secondary filter

m - white cabin

COMPLETE DUEL FUEL FILTER

F0560

83914074, D8NN9N074AA

- 1000, 115-90, 1180, 1280, 130-90, 1380, 140-90, 446, 450 Italian, 450R, 460, 466, 480, 500, 540, 550, 55-90, 566, 570, 580, 600, 60-66, 640, 65-66, 65-90, 65-93, 65-94, 666, 670, 680, 70-66, 70-90, 72-93, 72-94, 766, 780, 80-66, 80-66F, 80-76F, 80-90, 82-86F, 82-93, 82-94, 85-90, 880, 880-5, 88-93, 88-94, 900, 980



COOLANT FILTER

F83971970

83971970

- fits M100, M115, M135, M160



CHANGE IN FILTER

To replace TF5163 filter with the filter TF4159 the following parts are needed:

Connection nipple

FT5116767

5116767

Filter foot

FT5129631

5129631

C1.52

25.07.2008

DUST COLLECTOR PRE-CLEANER ASSEMBLY

Pre-cleaner saves the ordinary airfilter of the machine. In the dust collector the air rotates and the impurities will stay on the bottom of the pre-cleaner. It must be cleaned time to time.

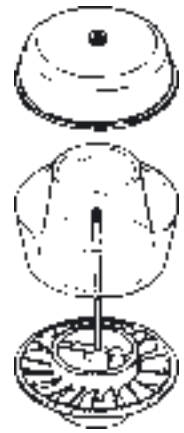

DFH001249

- pipe 3"/76 mm
- spare bowl **DFP020227**

DFH000820

- pipe 3"/76 mm
- spare bowl **DFP016330**

DFH000822

- pipe 4"/101 mm
- spare bowl **DFP016330**

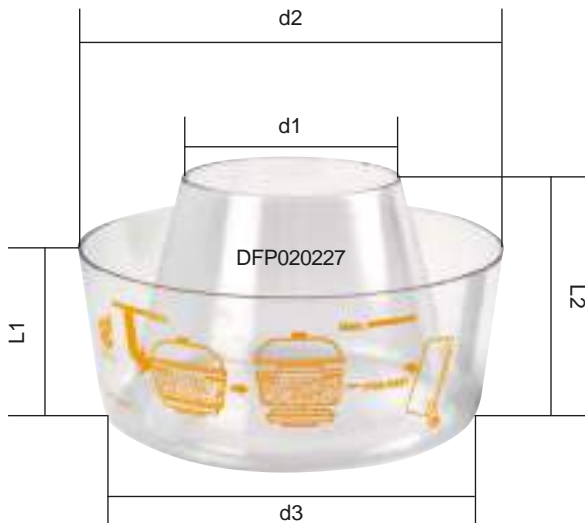

SPARE BOWL DIMENSION TABLE

DIMENSIONS	DFP020227	DFP016330
d1 mm	90	141
d2 mm	183,5	266
d3 mm	140	217,5
L1 mm	77	75,5
L2 mm	106	101,5



ALTERNATIVE IN ORIGINAL PACKAGE

- TF4076** = FT1909102
- TF4085** = FT1909101
- TF4159** = FT1909130
- TF4178** = FT1930213
- TF5163** = FT1909106
- TF6206** = FT1930010
- DFP502224** = F82005016