



Operation and Maintenance Manual

247, 257, 267, 277 and 287 Multi Terrain Loaders

CNC1-Up (Machine) [CAT00277CCNC01411](#)
CML1-Up (Machine)
CMM1-Up (Machine)
CMP1-Up (Machine)
CNY1-Up (Machine)

Important Safety Information

Most accidents that involve product operation, maintenance and repair are caused by failure to observe basic safety rules or precautions. An accident can often be avoided by recognizing potentially hazardous situations before an accident occurs. A person must be alert to potential hazards. This person should also have the necessary training, skills and tools to perform these functions properly.

Improper operation, lubrication, maintenance or repair of this product can be dangerous and could result in injury or death.

Do not operate or perform any lubrication, maintenance or repair on this product, until you have read and understood the operation, lubrication, maintenance and repair information.

Safety precautions and warnings are provided in this manual and on the product. If these hazard warnings are not heeded, bodily injury or death could occur to you or to other persons.

The hazards are identified by the "Safety Alert Symbol" and followed by a "Signal Word" such as "DANGER", "WARNING" or "CAUTION". The Safety Alert "WARNING" label is shown below.



The meaning of this safety alert symbol is as follows:

Attention! Become Alert! Your Safety is Involved.

The message that appears under the warning explains the hazard and can be either written or pictorially presented.

Operations that may cause product damage are identified by "NOTICE" labels on the product and in this publication.

Caterpillar cannot anticipate every possible circumstance that might involve a potential hazard. The warnings in this publication and on the product are, therefore, not all inclusive. If a tool, procedure, work method or operating technique that is not specifically recommended by Caterpillar is used, you must satisfy yourself that it is safe for you and for others. You should also ensure that the product will not be damaged or be made unsafe by the operation, lubrication, maintenance or repair procedures that you choose.

The information, specifications, and illustrations in this publication are on the basis of information that was available at the time that the publication was written. The specifications, torques, pressures, measurements, adjustments, illustrations, and other items can change at any time. These changes can affect the service that is given to the product. Obtain the complete and most current information before you start any job. Caterpillar dealers have the most current information available.



When replacement parts are required for this product Caterpillar recommends using Caterpillar replacement parts or parts with equivalent specifications including, but not limited to, physical dimensions, type, strength and material.

Failure to heed this warning can lead to premature failures, product damage, personal injury or death.

Table of Contents

Foreword	4
----------------	---

Safety Section

Safety Messages	6
General Hazard Information	22
Crushing Prevention and Cutting Prevention	24
Burn Prevention	24
Fire Prevention and Explosion Prevention	25
Fire Extinguisher Location	27
Electrical Storm Injury Prevention	27
Before Starting Engine	27
Engine Starting	27
Before Operation	28
Operation	28
Work Tools	28
Parking	29
Equipment Lowering with Engine Stopped	29
Sound Information and Vibration Information	29
Guards (Operator Protection)	30

Product Information Section

General Information	32
Identification Information	46

Operation Section

Before Operation	48
Machine Operation	54
Engine Starting	65
Operation	66
Parking	79
Transportation Information	82
Towing Information	85

Engine Starting (Alternate Methods)	86
---	----

Maintenance Section

Maintenance Access	88
Lubricant Viscosities and Refill Capacities	94
Maintenance Support	97
Maintenance Interval Schedule	98

Reference Information Section

Reference Materials	146
---------------------------	-----

Index Section

Index	151
-------------	-----

Foreword

Literature Information

This manual should be stored in the operator's compartment in the literature holder or seat back literature storage area.

This manual contains safety information, operation instructions, transportation information, lubrication information and maintenance information.

Some photographs or illustrations in this publication show details or attachments that can be different from your machine. Guards and covers might have been removed for illustrative purposes.

Continuing improvement and advancement of product design might have caused changes to your machine which are not included in this publication. Read, study and keep this manual with the machine.

Whenever a question arises regarding your machine, or this publication, please consult your Caterpillar dealer for the latest available information.

Safety

The safety section lists basic safety precautions. In addition, this section identifies the text and locations of warning signs and labels used on the machine.

Read and understand the basic precautions listed in the safety section before operating or performing lubrication, maintenance and repair on this machine.

Operation

The operation section is a reference for the new operator and a refresher for the experienced operator. This section includes a discussion of gauges, switches, machine controls, attachment controls, transportation and towing information.

Photographs and illustrations guide the operator through correct procedures of checking, starting, operating and stopping the machine.

Operating techniques outlined in this publication are basic. Skill and techniques develop as the operator gains knowledge of the machine and its capabilities.

Maintenance

The maintenance section is a guide to equipment care. The Maintenance Interval Schedule (MIS) lists the items to be maintained at a specific service interval. Items without specific intervals are listed under the "When Required" service interval. The Maintenance Interval Schedule lists the page number for the step-by-step instructions required to accomplish the scheduled maintenance. Use the Maintenance Interval Schedule as an index or "one safe source" for all maintenance procedures.

Maintenance Intervals

Use the service hour meter to determine servicing intervals. Calendar intervals shown (daily, weekly, monthly, etc.) can be used instead of service hour meter intervals if they provide more convenient servicing schedules and approximate the indicated service hour meter reading. Recommended service should always be performed at the interval that occurs first.

Under extremely severe, dusty or wet operating conditions, more frequent lubrication than is specified in the maintenance intervals chart might be necessary.

Perform service on items at multiples of the original requirement. For example, at every 500 service hours or 3 months, also service those items listed under every 250 service hours or monthly and every 10 service hours or daily.

California Proposition 65 Warning

Diesel engine exhaust and some of its constituents are known to the State of California to cause cancer, birth defects, and other reproductive harm.

Battery posts, terminals and related accessories contain lead and lead compounds. **Wash hands after handling.**

Certified Engine Maintenance

Proper maintenance and repair is essential to keep the engine and machine systems operating correctly. As the heavy duty off-road diesel engine owner, you are responsible for the performance of the required maintenance listed in the Owner Manual, Operation and Maintenance Manual, and Service Manual.

It is prohibited for any person engaged in the business of repairing, servicing, selling, leasing, or trading engines or machines to remove, alter, or render inoperative any emission related device or element of design installed on or in an engine or machine that is in compliance with the regulations (40 CFR Part 89). Certain elements of the machine and engine such as the exhaust system, fuel system, electrical system, intake air system and cooling system may be emission related and should not be altered unless approved by Caterpillar.

Machine Capacity

Additional attachments or modifications may exceed machine design capacity which can adversely affect performance characteristics. Included would be stability and system certifications such as brakes, steering, and rollover protective structures (ROPS). Contact your Caterpillar dealer for further information.

Caterpillar Product Identification Number

Effective First Quarter 2001 the Caterpillar Product Identification Number (PIN) has changed from 8 to 17 characters. In an effort to provide uniform equipment identification, Caterpillar and other construction equipment manufacturers are moving to comply with the latest version of the product identification numbering standard. Non-road machine PINs are defined by ISO 10261. The new PIN format will apply to all Caterpillar machines and generator sets. The PIN plates and frame marking will display the 17 character PIN. The new format will look like the following:

Product ID: CAT00277CCNC01411

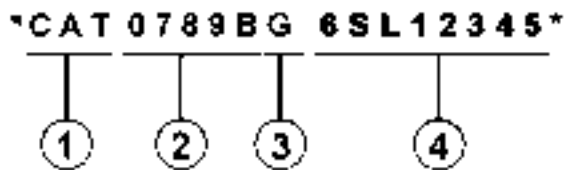

Illustration 1

g00751314

Where:

1. Caterpillar's World Manufacturing Code (characters 1-3)
2. Machine Descriptor (characters 4-8)

3. Check Character (character 9)

4. Machine Indicator Section (MIS) or Product Sequence Number (characters 10-17). These were previously referred to as the Serial Number.

Machines and generator sets produced before First Quarter 2001 will maintain their 8 character PIN format.

Components such as engines, transmissions, axles, etc. and work tools will continue to use an 8 character Serial Number (S/N).

Safety Section

i02114035

Safety Messages

SMCS Code: 7000; 7405

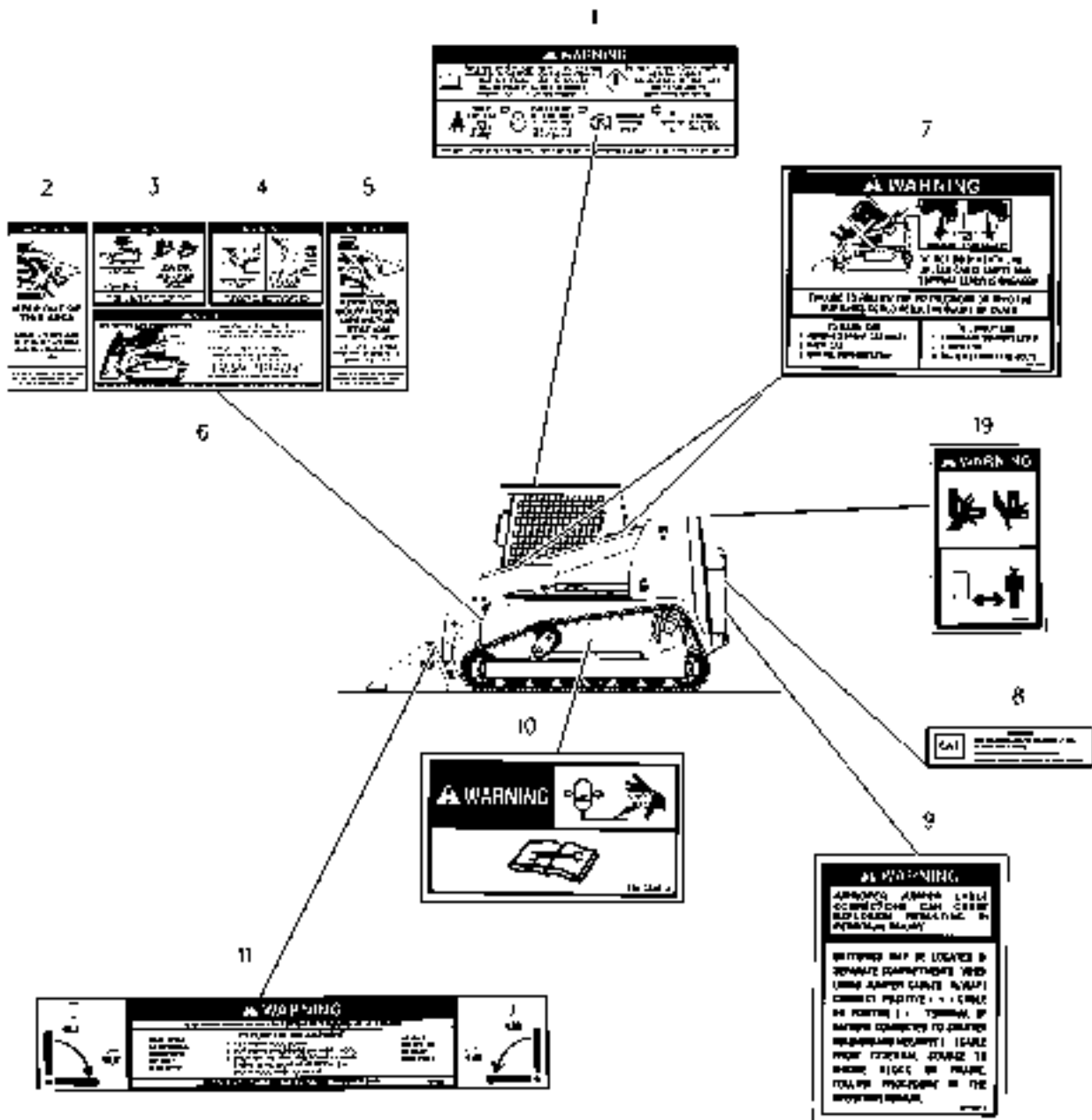

Illustration 2
Typical Example

g01005229

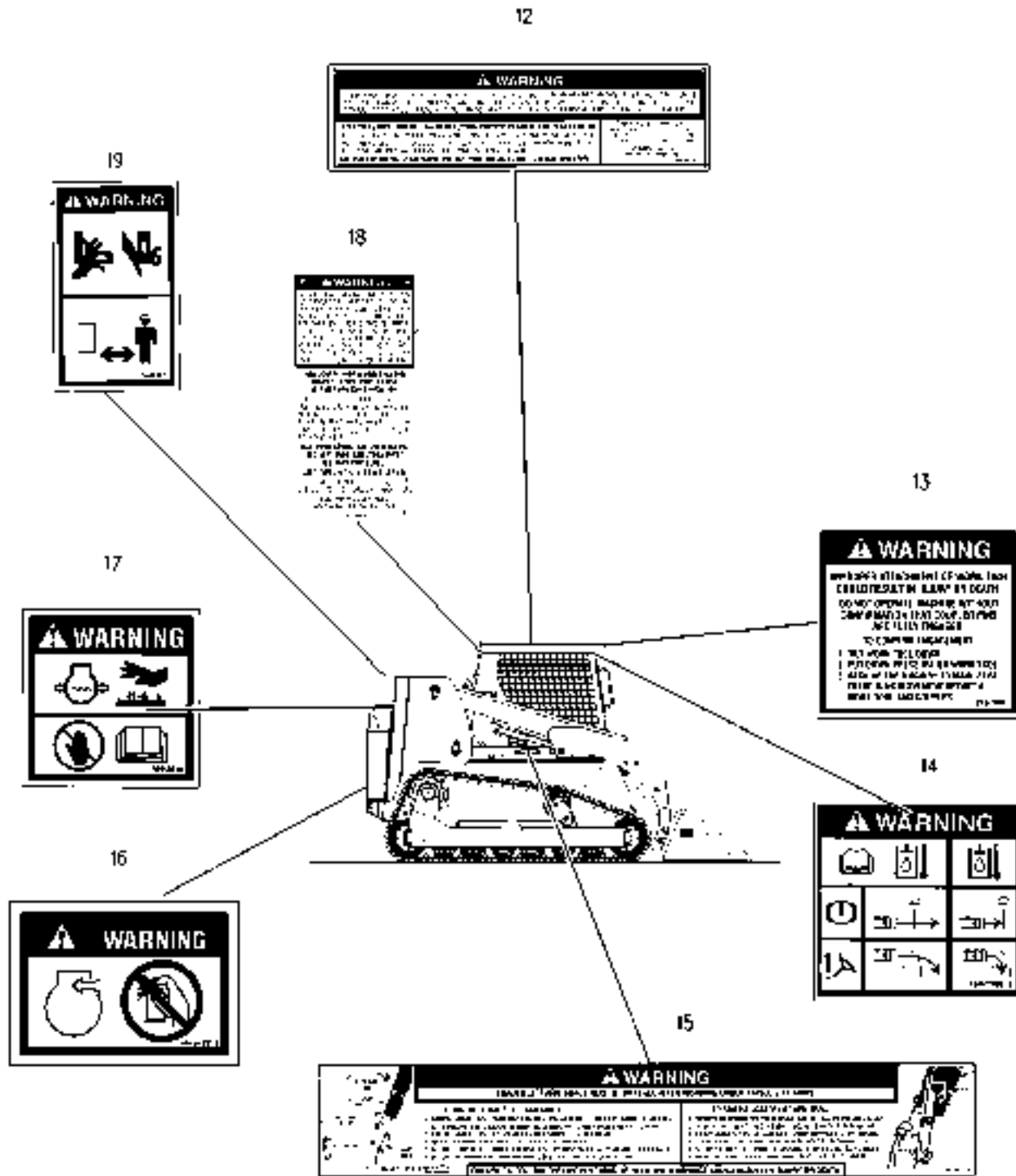

Illustration 3

Typical Example

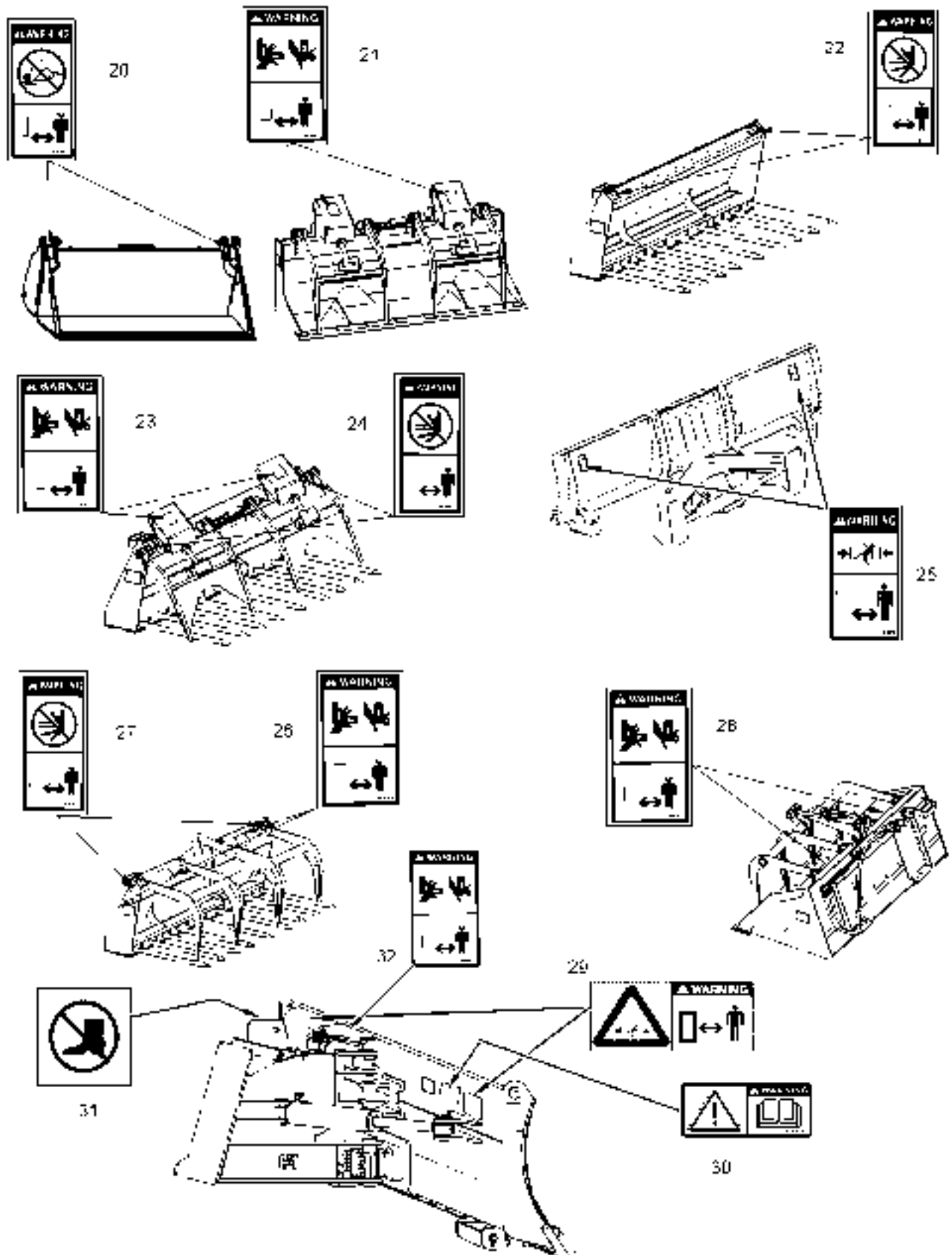

Illustration 4

There are several specific safety messages on this machine. The exact location of the hazards and the description of the hazards are reviewed in this section. Please become familiarized with all safety messages.

Make sure that all of the safety messages are legible. Clean the safety messages or replace the safety messages if you cannot read the words. Replace the illustrations if the illustrations are not legible. When you clean the safety messages, use a cloth, water and soap. Do not use solvent, gasoline, or other harsh chemicals to clean the safety messages. Solvents, gasoline, or harsh chemicals could loosen the adhesive that secures the safety message. Loose adhesive will allow the safety message to fall.

Replace any safety message that is damaged, or missing. If a safety message is attached to a part that is replaced, install a safety message on the replacement part. Any Caterpillar dealer can provide new safety messages.

Do Not Operate (1)

This warning message is located inside the cab on the left side.



g00943091



Read and understand the instructions and warnings in the operation and maintenance manuals. Contact any Caterpillar dealer for replacement manuals. Proper care is your responsibility.

Be alert! Know work conditions. Note and avoid all hazards and obstructions. Keep by-standers away when operating.

Fasten seat belt and lower armrest.

Make certain all controls are in neutral position and start engine.

Disengage parking brake.

Machine controls are active.

Failure to follow the instructions or heed the warnings could result injury or death.

Loader Crushing (2)

This message is located below the operator seat.



g00943101



Keep out of this area

Loader lift arm brace must be in place when working under raised lift arm.

Failure to follow the instructions or heed the warnings will result in death or serious injury.

Carrying a Load (3)

This warning message is located below the operator seat.



g00943103



Carry load low.

Do not exceed rated load.

Load, unload, turn on level ground.

Travel up and down slope with heaviest end of loader uphill.

Failure to follow the instructions or heed the warnings could result in injury or death.

Never Permit Riders (4)

This warning message is located below the operator seat.



g00943118



Never permit riders.

Never use work tool for a work platform.

Failure to follow the instructions or heed the warnings could result in injury or death.

Stay Inside Operator Station (5)

This warning message is located below the operator seat.



g00943119



Keep your body inside operator station while operating loader.

Never work with your arms, feet or legs beyond operator station.

Failure to follow the instructions or heed the warnings will result in death or serious injury.

Mounting and Dismounting (6)

This warning message is located below the operator seat.



g00943129



Mounting and Dismounting

Maintain 3-point contact (2 feet and 1 hand or 1 foot and 2 hands) with steps and handholds

When Leaving Loader:

1. Park machine on level ground
2. Lower work tool to ground
3. Stop engine and remove ignition key
4. Raise arm rest and remove seat belt

Park Brake is applied automatically

Failure to follow the instructions or heed the warnings could result in injury or death

Cab Support (7)

This warning message is located on the left side of the machine near the cab support lever. This warning message is also located inside the cab on the left side.



g00943135



Do not go beneath cab unless cab is empty and support lever is engaged.

Failure to follow the instructions or heed the warnings could result in injury or death.

Battery (8)

This warning message is located on the battery.

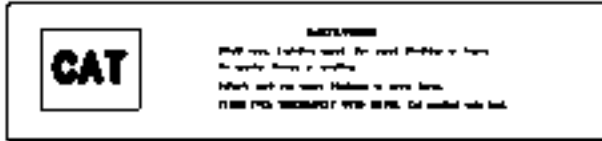

g00943142



DANGER/POISON

Shield eyes, Explosive gases. Can cause blindness or injury.

No sparks, flames or smoking.

Sulfuric Acid can cause blindness or severe burns.

FLUSH EYES IMMEDIATELY WITH WATER. Get medical help fast.

Keep out of reach of children. Contains sulfuric acid. For medical emergency in USA or Canada contact: 800-458-5924, other countries contact: 303-893-1322.

Batteries (9)

This warning message is located on the inside of the engine access door.

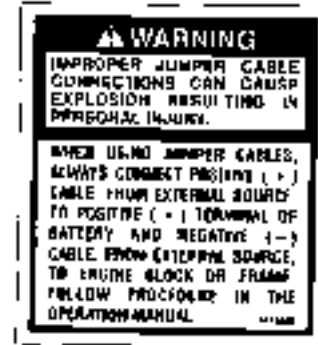

g00943143



Improper jumper cable connections can cause explosion resulting in personal injury. Batteries may be located in separate compartments, always connect positive (+) cable to positive (+) terminal of battery connected to starter solenoid and negative (-) cable from external source to engine block or frame.

Accumulator (10)

This warning message is located near the accumulator.



g00943144



Accumulator may contain high pressure oil. Do not service the accumulator or any hydraulic lines until all of the pressure has been relieved. See the Service Manual for proper procedures. Failure to heed this warning could result in injury or death.

Work Tool Coupler (11)

This warning message is located on the coupler assembly.



g00943146



Do not operate machine without confirmation that coupler pins are fully engaged

Make certain all hydraulic connections are tight (if equipped)

Use only Caterpillar approved work tools

Improper attachment of work tool could result in injury or death

Tilt the work tool downward.

Put down pressure on the work tool.

Move the machine backward. Ensure that the work tool has not separated from the coupler assembly.

Falling Object Protective Structure (12)

This warning message is located on the right side of the FOPS.



g00943148



Structural damage, an overturn, modification, alteration, or improper repair can impair this structure's protection capability thereby voiding this certification. Do not weld on or drill holes in the structure. Consult a Caterpillar dealer to determine this structure's limitations without voiding its certification.

This structure, when properly installed on a machine meets, at the time of installation, criteria established by: TOP GUARD: SAE J231, JAN 81, "ISO 3449 Level II".

Work Tool Coupler (13)

This warning message is located inside the cab near the hydraulic quick coupler control.



g00943149



Improper Attachment of the Work Tool could result in injury or death.

Do not operate the machine without confirmation that the coupler pins are fully engaged. Follow the operating procedures in the Operation and Maintenance Manual.

Tilt the work tool downward.

Put down pressure on the work tool.

Move the machine backward. Ensure that the work tool has not separated from the coupler assembly.

Machine Operation in Cold Weather (14)

This warning message is located inside the cab on the right side.



g00943150



The braking and steering system of this machine react differently when the hydraulic oil is cold. Operating the machine with cold hydraulic oil requires extra stopping and turning clearances. Failure to follow the instructions or heed the warnings could result in injury or death.

Refer to Operation and Maintenance Manual, "Engine Starting" for information on machine preparation for cold weather.

Brace for the Loader Lift Arms (15)

This warning message is located on the brace for the loader lift arms. The illustration may vary depending on the machine that is being serviced. However, the location of the label will remain unchanged.



g00943151



Loader lift arm brace must be in place when working under raised lift arms.

Failure to follow the instructions or heed the warnings could result in injury or death.

Refer to Operation and Maintenance Manual, "Loader Lift Arm Brace Operation" for operating information.

Aerosol Starting Aid (16)

This warning message is located on top of the fuel pump housing.



g00943154



Do not use aerosol types of starting aids such as ether. Such use could result in an explosion and personal injury.

Pressurized System (17)

This warning message is located below the radiator cap.



g00943155



Pressurized system: Hot coolant can cause serious burn. To open cap, stop engine, wait until radiator is cool. Then loosen cap slowly to relieve the pressure.

Rollover Protective Structure/ Falling Object Protective Structure (18)

This warning message is located inside the cab on the upper left side.



g00943157



Structural damage, an overturn, modification, alteration, or improper repair can impair this structure's protection capability thereby voiding this certification. Do not weld on or drill holes in the structure. Consult a Caterpillar dealer to determine this structure's limitations without voiding its certification.

Crush Point (19)

The warning messages that are shown are used on the 257 Multi Terrain Loaders and the 277 Multi Terrain Loaders. The messages are located near the back of the machine on each side.



g00943160



No clearance for person in this area during operation. Severe injury or death from crushing could occur. Stay away from the work tool while it is in operation.

Multipurpose Bucket (20)

These warning messages are located on the front of the multipurpose bucket.



g00943159



No clearance for person in this area during operation. Severe injury or death from crushing could occur. Stay away from the work tool while it is in operation.

Industrial Grapple Bucket (21)

These warning messages are located on top of the guards for the grapple cylinders.



g00943160



No clearance for person in this area during operation. Severe injury or death from crushing could occur. Stay away from the work tool while it is in operation.

Industrial Grapple Fork (23)

These warning messages are located on the guards for the grapple cylinders.



g00943172



No clearance for person in this area during operation. Severe injury or death from crushing could occur. Stay away from the work tool while it is in operation.

Utility Fork (22)

These warning messages are located on top of the fork carriage.



g00943161



No clearance for person in this area during operation. Severe injury or death from impalement could occur. Stay away from the work tool while it is in operation.

Industrial Grapple Fork (24)

These warning messages are located on top of the fork carriage.



g00943175



No clearance for person in this area during operation. Severe injury or death from impalement could occur. Stay away from the work tool while it is in operation.

Angle Blade (25)

These warning messages are located on the back side of the blade.

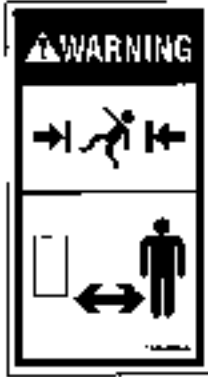

g00943177



No clearance for person in this area during operation. Severe injury or death from crushing could occur. Stay away from the work tool while it is in operation.

Utility Grapple Fork (27)

These warning messages are located on top of the fork carriage.



g00943179



No clearance for person in this area during operation. Severe injury or death from impalement could occur. Stay away from the work tool while it is in operation.

Utility Grapple Fork (26)

These warning messages are located on top of the grapple frame.



g00943178



No clearance for person in this area during operation. Severe injury or death from crushing could occur. Stay away from the work tool while it is in operation.

Utility Grapple Bucket (28)

These warning messages are located on top of the grapple frame.



g00943180



No clearance for person in this area during operation. Severe injury or death from crushing could occur. Stay away from the work tool while it is in operation.

Dozer Blade (29)

These warning messages are located on the back side of the blade.

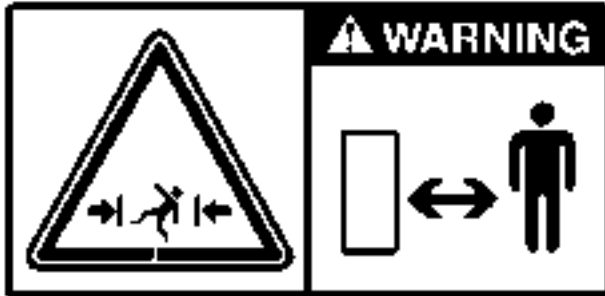

g01039066



No clearance for person in this area during operation. Severe injury or death from crushing could occur. Stay away from the work tool while it is in operation.

Dozer Blade (30)

This warning is located on right hand side on the back of the blade.



g00934493



DO NOT OPERATE OR WORK ON THIS MACHINE UNLESS YOU HAVE READ AND UNDERSTAND THE INSTRUCTIONS AND WARNINGS IN THE OPERATION AND MAINTENANCE MANUALS. FAILURE TO FOLLOW THE INSTRUCTIONS OR HEED THE WARNINGS COULD RESULT IN INJURY OR DEATH. CONTACT ANY CATERPILLAR DEALER FOR REPLACEMENT MANUALS. PROPER CARE IS YOUR RESPONSIBILITY.

Dozer Blade (31)

This warning message is located on top of the dozer blade.



g00946617



Falling Hazard - Area may be oily and slippery. Do not step on cylinders. Serious injury or death could occur from a fall.

Dozer Blade (32)

This warning message is located on top of the dozer blade.



g00943180



No clearance for person in this area during operation. Severe injury or death from crushing could occur. Stay away from the work tool while it is in operation.

i02443908

General Hazard Information

SMCS Code: 7000

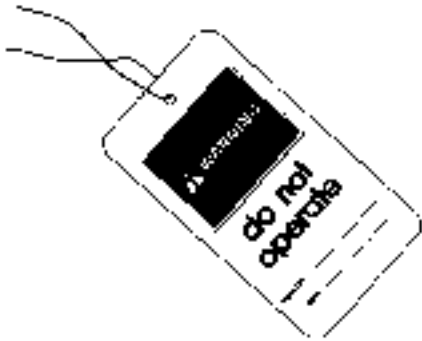

Illustration 5

g00104545

Attach a “Do Not Operate” warning tag or a similar warning tag to the start switch or to the controls before you service the equipment or before you repair the equipment. These warning tags (Special Instruction, SEHS7332) are available from your Caterpillar dealer.

Know the width of your equipment in order to maintain proper clearance when you operate the equipment near fences or near boundary obstacles.

Be aware of high voltage power lines and power cables that are buried. If the machine comes in contact with these hazards, serious injury or death may occur from electrocution.



Illustration 6

g00702020

Wear a hard hat, protective glasses, and other protective equipment, as required.

Do not wear loose clothing or jewelry that can snag on controls or on other parts of the equipment.

Make sure that all protective guards and all covers are secured in place on the equipment.

Keep the equipment free from foreign material. Remove debris, oil, tools, and other items from the deck, from walkways, and from steps.

Secure all loose items such as lunch boxes, tools, and other items that are not a part of the equipment.

Know the appropriate work site hand signals and the personnel that are authorized to give the hand signals. Accept hand signals from one person only.

Do not smoke when you service an air conditioner. Also, do not smoke if refrigerant gas may be present. Inhaling the fumes that are released from a flame that contacts air conditioner refrigerant can cause bodily harm or death. Inhaling gas from air conditioner refrigerant through a lighted cigarette can cause bodily harm or death.

Never put maintenance fluids into glass containers. Drain all liquids into a suitable container.

Obey all local regulations for the disposal of liquids.

Use all cleaning solutions with care. Report all necessary repairs.

Do not allow unauthorized personnel on the equipment.

Unless you are instructed otherwise, perform maintenance with the equipment in the servicing position. Refer to Operation and Maintenance Manual for the procedure for placing the equipment in the servicing position.

Pressurized Air and Water

Pressurized air and/or water can cause debris and/or hot water to be blown out. This could result in personal injury.

When pressurized air and/or pressurized water is used for cleaning, wear protective clothing, protective shoes, and eye protection. Eye protection includes goggles or a protective face shield.

The maximum air pressure for cleaning purposes must be reduced to 205 kPa (30 psi) when the nozzle is deadheaded and the nozzle is used with an effective chip deflector and personal protective equipment. The maximum water pressure for cleaning purposes must be below 275 kPa (40 psi).

Trapped Pressure

Pressure can be trapped in a hydraulic system. Releasing trapped pressure can cause sudden machine movement or attachment movement. Use caution if you disconnect hydraulic lines or fittings. High pressure oil that is released can cause a hose to whip. High pressure oil that is released can cause oil to spray. Fluid penetration can cause serious injury and possible death.

Fluid Penetration

Pressure can be trapped in the hydraulic circuit long after the engine has been stopped. The pressure can cause hydraulic fluid or items such as pipe plugs to escape rapidly if the pressure is not relieved correctly.

Do not remove any hydraulic components or parts until pressure has been relieved or personal injury may occur. Do not disassemble any hydraulic components or parts until pressure has been relieved or personal injury may occur. Refer to the Service Manual for any procedures that are required to relieve the hydraulic pressure.

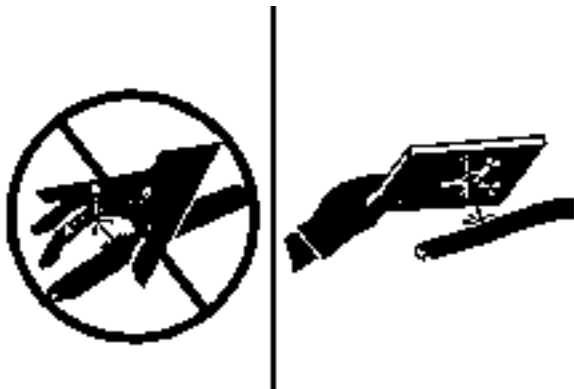

Illustration 7

g00687600

Always use a board or cardboard when you check for a leak. Leaking fluid that is under pressure can penetrate body tissue. Fluid penetration can cause serious injury and possible death. A pin hole leak can cause severe injury. If fluid is injected into your skin, you must get treatment immediately. Seek treatment from a doctor that is familiar with this type of injury.

Containing Fluid Spillage

Care must be taken in order to ensure that fluids are contained during performance of inspection, maintenance, testing, adjusting and repair of the equipment. Prepare to collect the fluid with suitable containers before opening any compartment or disassembling any component that contains fluids.

Refer to Special Publication, NENG2500, "Caterpillar Dealer Service Tool Catalog" for the following items:

- Tools that are suitable for collecting fluids and equipment that is suitable for collecting fluids
- Tools that are suitable for containing fluids and equipment that is suitable for containing fluids

Obey all local regulations for the disposal of liquids.

Asbestos Information



Illustration 8

g00702022

Caterpillar equipment and replacement parts that are shipped from Caterpillar are asbestos free. Caterpillar recommends the use of only genuine Caterpillar replacement parts. Use the following guidelines when you handle any replacement parts that contain asbestos or when you handle asbestos debris.

Use caution. Avoid inhaling dust that might be generated when you handle components that contain asbestos fibers. Inhaling this dust can be hazardous to your health. The components that may contain asbestos fibers are brake pads, brake bands, lining material, clutch plates, and some gaskets. The asbestos that is used in these components is usually bound in a resin or sealed in some way. Normal handling is not hazardous unless airborne dust that contains asbestos is generated.

If dust that may contain asbestos is present, there are several guidelines that should be followed:

- Never use compressed air for cleaning.
- Avoid brushing materials that contain asbestos.
- Avoid grinding materials that contain asbestos.
- Use a wet method in order to clean up asbestos materials.
- A vacuum cleaner that is equipped with a high efficiency particulate air filter (HEPA) can also be used.

- Use exhaust ventilation on permanent machining jobs.
- Wear an approved respirator if there is no other way to control the dust.
- Comply with applicable rules and regulations for the work place. In the United States, use Occupational Safety and Health Administration (OSHA) requirements. These OSHA requirements can be found in "29 CFR 1910.1001".
- Obey environmental regulations for the disposal of asbestos.
- Stay away from areas that might have asbestos particles in the air.

Dispose of Waste Properly



Illustration 9

g00706404

Improperly disposing of waste can threaten the environment. Potentially harmful fluids should be disposed of according to local regulations.

Always use leakproof containers when you drain fluids. Do not pour waste onto the ground, down a drain, or into any source of water.

i01359664

Crushing Prevention and Cutting Prevention

SMCS Code: 7000

Support the equipment properly before you perform any work or maintenance beneath that equipment. Do not depend on the hydraulic cylinders to hold up the equipment. Equipment can fall if a control is moved, or if a hydraulic line breaks.

Do not work beneath the cab of the machine unless the cab is properly supported.

Unless you are instructed otherwise, never attempt adjustments while the machine is moving or while the engine is running.

Never jump across the starter solenoid terminals in order to start the engine. Unexpected machine movement could result.

Whenever there are equipment control linkages the clearance in the linkage area will change with the movement of the equipment or the machine. Stay clear of areas that may have a sudden change in clearance with machine movement or equipment movement.

Stay clear of all rotating and moving parts.

If it is necessary to remove guards in order to perform maintenance, always install the guards after the maintenance is performed.

Keep objects away from moving fan blades. The fan blade will throw objects or cut objects.

Do not use a kinked wire cable or a frayed wire cable. Wear gloves when you handle wire cable.

When you strike a retainer pin with force, the retainer pin can fly out. The loose retainer pin can injure personnel. Make sure that the area is clear of people when you strike a retainer pin. To avoid injury to your eyes, wear protective glasses when you strike a retainer pin.

Chips or other debris can fly off an object when you strike the object. Make sure that no one can be injured by flying debris before striking any object.

i01329099

Burn Prevention

SMCS Code: 7000

Do not touch any part of an operating engine. Allow the engine to cool before any maintenance is performed on the engine. Relieve all pressure in the air system, in the oil system, in the lubrication system, in the fuel system, or in the cooling system before any lines, fittings or related items are disconnected.

Coolant

When the engine is at operating temperature, the engine coolant is hot. The coolant is also under pressure. The radiator and all lines to the heaters or to the engine contain hot coolant.

Any contact with hot coolant or with steam can cause severe burns. Allow cooling system components to cool before the cooling system is drained.

Check the coolant level only after the engine has been stopped.

Ensure that the filler cap is cool before removing the filler cap. The filler cap must be cool enough to touch with a bare hand. Remove the filler cap slowly in order to relieve pressure.

Cooling system conditioner contains alkali. Alkali can cause personal injury. Do not allow alkali to contact the skin, the eyes, or the mouth.

Oils

Hot oil and hot components can cause personal injury. Do not allow hot oil to contact the skin. Also, do not allow hot components to contact the skin.

Remove the hydraulic tank filler cap only after the engine has been stopped. The filler cap must be cool enough to touch with a bare hand. Follow the standard procedure in this manual in order to remove the hydraulic tank filler cap.

Batteries

Electrolyte is an acid. Electrolyte can cause personal injury. Do not allow electrolyte to contact the skin or the eyes. Always wear protective glasses for servicing batteries. Wash hands after touching the batteries and connectors. Use of gloves is recommended.

i01359795

Fire Prevention and Explosion Prevention

SMCS Code: 7000



Illustration 10

g00704000

All fuels, most lubricants, and some coolant mixtures are flammable.

Flammable fluids that are leaking or spilled onto hot surfaces or onto electrical components can cause a fire. Fire may cause personal injury and property damage.

Remove all flammable materials such as fuel, oil, and debris from the machine. Do not allow any flammable materials to accumulate on the machine.

Store fuels and lubricants in properly marked containers away from unauthorized persons. Store oily rags and any flammable materials in protective containers. Do not smoke in areas that are used for storing flammable materials.

Do not operate the machine near any flame.

Exhaust shields (if equipped) protect hot exhaust components from oil spray or fuel spray in case of a break in a line, in a hose, or in a seal. Exhaust shields must be installed correctly.

Do not weld on lines or on tanks that contain flammable fluids. Do not flame cut lines or tanks that contain flammable fluid. Clean any such lines or tanks thoroughly with a nonflammable solvent prior to welding or flame cutting.

Check all electrical wires daily. Repair any wires that are loose or frayed before you operate the machine. Clean all electrical connections and tighten all electrical connections.

Dust that is generated from repairing nonmetallic hoods or nonmetallic fenders can be flammable and/or explosive. Repair such components in a well ventilated area away from open flames or sparks.

Inspect all lines and hoses for wear or for deterioration. The hoses must be properly routed. The lines and the hoses must have adequate support and secure clamps. Tighten all connections to the recommended torque. Leaks can cause fires.



Illustration 11

g00704059

Use caution when you are refueling a machine. Do not smoke while you are refueling a machine. Do not refuel a machine near open flames or sparks. Always stop the engine before refueling. Fill the fuel tank outdoors.

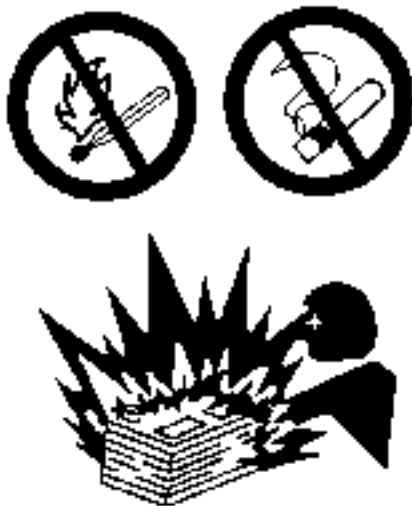

Illustration 12

g00704135

Gases from a battery can explode. Keep any open flames or sparks away from the top of a battery. Do not smoke in battery charging areas.

Never check the battery charge by placing a metal object across the terminal posts. Use a voltmeter or a hydrometer.

Improper jumper cable connections can cause an explosion that can result in injury. Refer to the Operation Section of this manual for specific instructions.

Do not charge a frozen battery. This may cause an explosion.

Fire Extinguisher

Make sure that a fire extinguisher is available. Be familiar with the operation of the fire extinguisher. Inspect the fire extinguisher and service the fire extinguisher regularly. Obey the recommendations on the instruction plate.

Ether

Ether is flammable and poisonous.

Use ether in well ventilated areas. Do not smoke while you are replacing an ether cylinder or while you are using an ether spray.

Do not store ether cylinders in living areas or in the operator compartment of a machine. Do not store ether cylinders in direct sunlight or in temperatures above 49 °C (120 °F). Keep ether cylinders away from open flames or sparks.

Dispose of used ether cylinders properly. Do not puncture an ether cylinder. Keep ether cylinders away from unauthorized personnel.

Do not spray ether into an engine if the machine is equipped with a thermal starting aid for cold weather starting.

Lines, Tubes and Hoses

Do not bend high pressure lines. Do not strike high pressure lines. Do not install any lines that are bent or damaged.

Repair any lines that are loose or damaged. Leaks can cause fires. Consult your Caterpillar dealer for repair or for replacement parts.

Check lines, tubes and hoses carefully. Do not use your bare hand to check for leaks. Use a board or cardboard to check for leaks. Tighten all connections to the recommended torque.

Replace the parts if any of the following conditions are present:

- End fittings are damaged or leaking.
- Outer coverings are chafed or cut.

- Wires are exposed.
- Outer coverings are ballooning.
- Flexible part of the hoses are kinked.
- Outer covers have embedded armoring.
- End fittings are displaced.

Make sure that all clamps, guards, and heat shields are installed correctly. During machine operation, this will help to prevent vibration, rubbing against other parts, and excessive heat.

i01820946

Fire Extinguisher Location

SMCS Code: 7000; 7419

Make sure that a fire extinguisher is on the machine. Make sure that you are familiar with the operation of the fire extinguisher. Inspect the fire extinguisher and service the fire extinguisher. Obey the recommendations on the instruction plate.

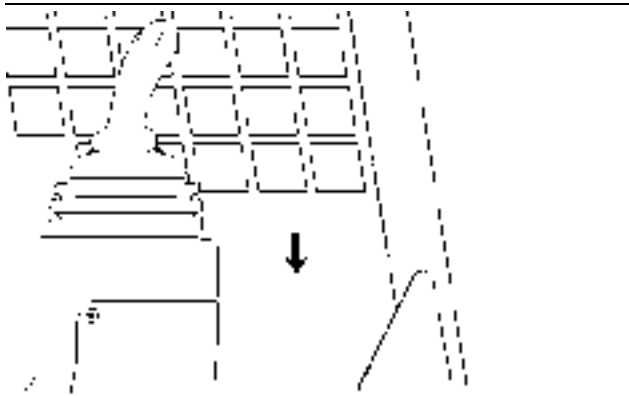

Illustration 13

g00929625

Mount the fire extinguisher on the left side of the cab floor in front of the console for the speed/direction control. Consult your Caterpillar dealer for the proper procedure for mounting the fire extinguisher.

i01122596

Electrical Storm Injury Prevention

SMCS Code: 7000

When lightning is striking in the vicinity of the machine, the operator should never attempt the following procedures:

- Mount the machine.

- Dismount the machine.

If you are in the operator's station during an electrical storm, stay in the operator's station. If you are on the ground during an electrical storm, stay away from the vicinity of the machine.

i00771840

Before Starting Engine

SMCS Code: 1000; 7000

Start the engine only from the operator compartment. Never short across the starter terminals or across the batteries. Shorting could damage the electrical system by bypassing the engine neutral start system.

Inspect the condition of the seat belt and of the mounting hardware. Replace any parts that are worn or damaged. Regardless of appearance, replace the seat belt after three years of use. Do not use a seat belt extension on a retractable seat belt.

Adjust the seat so that full pedal travel can be achieved with the operator's back against the back of the seat.

Make sure that the machine is equipped with a lighting system that is adequate for the job conditions. Make sure that all machine lights are working properly.

Before you start the engine and before you move the machine, make sure that no one is underneath the machine, around the machine, or on the machine. Make sure that the area is free of personnel.

i01027818

Engine Starting

SMCS Code: 1000; 7000

If a warning tag is attached to the start switch or to the controls, do not start the engine. Also, do not move any controls.

Move all hydraulic controls to the HOLD position before you start the engine.

Diesel engine exhaust contains products of combustion which can be harmful to your health. Always start the engine in a well ventilated area. Always operate the engine in a well ventilated area. If you are in an enclosed area, vent the exhaust to the outside.

i01545253

Before Operation

SMCS Code: 7000

A video tape is available in English in North American format for the machine. Contact your Caterpillar dealer in order to obtain a copy of Skid Steer Safety and Operating Tips, AEVN4482. The video tape should be viewed by every person that operates the machine.

Clear all personnel from the machine and from the area.

Clear all obstacles from the path of the machine. Beware of hazards such as wires, ditches, etc.

Make sure that all windows are clean. Secure all doors in the closed position. Secure the windows in the open position or in the shut position.

Make sure that the machine horn (if equipped), the backup alarm (if equipped) and all other warning devices are working properly.

Fasten the seat belt securely. Lower the armrest.

i01762042

Operation

SMCS Code: 7000

Only operate the machine while you are in the seat. The seat belt must be fastened while you operate the machine. Only operate the controls while the engine is running.

Before you move the machine, you must be certain that no one will be endangered.

While you operate the machine and the work tool slowly in an open area, check for proper operation of all controls and all protective devices.

Do not allow riders on the machine.

Note any needed repairs during machine operation. Report any needed repairs.

Use only Caterpillar Approved Work Tools on this machine. Obey all the lift restrictions. Refer to Operation and Maintenance Manual, "Caterpillar Approved Work Tools" for the approved work tools and the lift restriction information.

Carry work tools low. Lower the lift arms fully. Tilt back the work tool in order to keep the work tool off of the ground. Do not go close to the edge of a cliff, an excavation, or an overhang.

If the machine begins to sideslip downward on a slope, immediately remove the load and move the machine backward down the slope.

Avoid any conditions that can lead to tipping the machine. The machine can tip when you work on banks and on slopes. Also, the machine can tip when you cross ditches, ridges or other unexpected obstacles. Never exceed a slope that is greater than 3 to 1 (18.4 degrees).

Maintain control of the machine. Do not overload the machine beyond the machine capacity.

Never straddle a wire cable. Never allow personnel to straddle a wire cable.

Know the maximum dimensions of your machine.

Always keep the Rollover Protective Structure (ROPS) installed during machine operation.

Machine Operating Temperature Range. The machine must function satisfactorily in the anticipated ambient temperature limits that are encountered during operation. The minimum limits of items that will effect the safe operation of the machine to be considered are 0-100% relative humidity for -32 °C (-25 °F) to 43 °C (109.4 °F) temperatures unless otherwise specified in marketing functional specification.

Observe any local government regulations when you use the machine to lift heavy objects.

i01115299

Work Tools

SMCS Code: 6700

Only use work tools that are approved by Caterpillar for use on Caterpillar machines. Refer to the Operation and Maintenance Manual, "Caterpillar Approved Work Tools".

If you are in doubt about the compatibility of a particular work tool with your machine, consult your Caterpillar dealer.

Make sure that all necessary guarding is in place on the host machine and on the work tool.

Keep all windows and doors closed on the host machine. Always wear protective glasses. Always wear the protective equipment that is recommended in the work tool's operation manual. Wear any other protective equipment that is required for the operating environment.

To prevent personnel from being struck by flying objects, ensure that all personnel are out of the work area.

While you are performing any maintenance, any testing, or any adjustments to the work tool stay clear of the following areas: cutting edges, pinching surfaces, and crushing surfaces.

i01487624

Parking

SMCS Code: 7000

Park on a level surface. If you must park on a grade, chock the machine.

1. Move the speed/direction control lever slowly to the HOLD position in order to stop the machine.
2. Move the governor control lever to the LOW IDLE position.
3. Lower the loader arms and tilt the linkage so that the work tool rests firmly on the ground.
4. Stop the engine. Keep the armrest in the LOWERED position.
5. Turn the engine start switch key to the ON position. Push the parking brake switch.
6. Move all hydraulic control levers while you are pressing several times on each side of the auxiliary hydraulic control (if equipped) and the high flow control (if equipped) in order to relieve hydraulic pressure.
7. Move the hydraulic control levers to the HOLD position.
8. Turn the engine start switch key to OFF position and remove the key.

i01329161

Equipment Lowering with Engine Stopped

SMCS Code: 7000

Before lowering any equipment with the engine stopped, clear the area around the equipment of all personnel. The procedure to use will vary with the type of equipment to be lowered. Keep in mind most systems use a high pressure fluid or air to raise or lower equipment. The procedure will cause high pressure air, hydraulic, or some other media to be released in order to lower the equipment. Wear appropriate personal protective equipment and follow the established procedure in the Operation and Maintenance Manual, "Equipment Lowering with Engine Stopped" in the Operation Section of the manual.

i01879541

Sound Information and Vibration Information

SMCS Code: 7000

Sound Performance for Machines that are Offered in European Union Countries and in Countries that Adopt the EU Directives

The operator sound pressure levels are measured according to dynamic test procedures and conditions that are specified in "ISO 6396".

Hearing protection may be required under the following conditions:

- The machine is operated with an open operator station.
- The windows and doors are not properly maintained.
- The machine is operated for extended periods.
- The machine is operated in a noisy environment.

Machines that are manufactured by Caterpillar meet the criteria for exterior sound power levels that are specified in the European Directives. The European Directives are noted on the Certificate of Conformance and the accompanying label.

The interior sound power level is 84 dB(A) for the 277 and 287 machines. The interior sound power level is 89 dB(A) for the 247, 257 and 267 machines. The exterior sound power level is 106 dB(A). These levels are measured according to the test procedures and conditions that are specified in "2000/14/EC".

Machine Vibration Levels

The hands and arms are subject to a weighted root mean square acceleration that is 2.5 m/s² (8.2 ft/s²).

The whole body is subject to a weighted root mean square acceleration that is 0.6 m/s² (2.3 ft/s²).

The measurements are obtained on a representative machine by using the procedures that are in the following standards:

- "ISO 2631/1"
- "ISO 5349"
- "SAE J1166"

i01992325

Guards (Operator Protection)

SMCS Code: 7150-MCH; 7325

There are different types of guards that are used to protect the operator. The machine and the machine application determines the type of guard that should be used.

A daily inspection of the guards is required in order to check for structures that are bent, cracked or loose. Never operate a machine with a damaged structure.

The operator becomes exposed to a hazardous situation if the machine is used improperly or if poor operating techniques are used. This situation can occur even though a machine is equipped with an appropriate protective guard. Follow the established operating procedures that are recommended for your machine.

Rollover Protective Structure (ROPS), Falling Object Protective Structure (FOPS) or Tip Over Protection Structure (TOPS)

The ROPS/FOPS Structure (if equipped) on your machine is specifically designed, tested and certified for that machine. Excavators are not equipped with ROPS structures. Any alteration or any modification to the ROPS/FOPS Structure could weaken the structure. This places the operator into an unprotected environment. Modifications or attachments that cause the machine to exceed the weight that is stamped on the certification plate also place the operator into an unprotected environment. Excessive weight may inhibit the brake performance, the steering performance and the ROPS. The protection that is offered by the ROPS/FOPS Structure will be impaired if the ROPS/FOPS Structure has structural damage. Damage to the structure can be caused by an overturn, a falling object, a collision, etc.

Do not mount items (fire extinguishers, first aid kits, work lights, etc) by welding brackets to the ROPS/FOPS Structure or by drilling holes in the ROPS/FOPS Structure. Welding brackets or drilling holes in the ROPS/FOPS Structures can weaken the structures. Consult your Caterpillar dealer for mounting guidelines.

The Tip Over Protection Structure (TOPS) is another type of guard that is used on mini hydraulic excavators. This structure protects the operator in the event of a tipover. The same guidelines for the inspection, the maintenance and the modification of the ROPS/FOPS Structure are required for the Tip Over Protection Structure.

Other Guards (If Equipped)

Protection from flying objects and/or falling objects is required for special applications. Logging applications and demolition applications are two examples that require special protection.

A front guard needs to be installed when a work tool that creates flying objects is used. Mesh front guards that are approved by Caterpillar or polycarbonate front guards that are approved by Caterpillar are available for machines with a cab or an open canopy. On machines that are equipped with cabs, the windshield should also be closed. Safety glasses are recommended when flying hazards exist for machines with cabs and machines with open canopies.

If the work material extends above the cab, top guards and front guards should be used. Typical examples of this type of application are listed below:

- Demolition applications
- Rock quarries
- Forestry products

Additional guards may be required for specific applications or work tools. The Operation and Maintenance Manual for your machine or your work tool will provide specific requirements for the guards. Consult your Caterpillar dealer for additional information.

Product Information Section

General Information

i01896611

Rated Load

SMCS Code: 6001; 6136; 6542; 7000

Bucket Rated Load

WARNING

Failure to comply to the rated load can cause possible personal injury or property damage. Review the rated load of a particular work tool before performing any operation. Make adjustments to the rated load as necessary for non-standard configurations.

Note: Rated loads should be used as a guide. Attachments, uneven ground conditions, soft ground conditions, or poor ground conditions have effects on rated loads. The operator is responsible for being aware of these effects.

Rated loads are based upon a standard machine with the following conditions:

- lubricants
- full fuel tank
- 75 kg (165 lb) operator

Rated loads will vary with different attachments. Contact your Caterpillar dealer regarding the rated load for specific attachments.

The rated operating load for skid steer loaders that are equipped with rubber tires is defined by the SAE standard "J818" (May 1987) and by the ISO 5998 (1986) as 50% of the full static tipping load on a hard, smooth, level surface. The rated operating load for machines that are equipped with steel tracks is defined by the SAE standard "J818" (May 1987) and by the ISO 5998 (1986) as 35% of the full static tipping load on a soft, less smooth or level surface.

The corresponding dump clearance is given for each bucket at maximum lift height and at a 40 degree dump angle. The reach is given for each bucket at maximum lift height and at a 40 degree dump angle. Clearance is measured from the ground to the bucket edge in order to dump the load. The reach is measured from the front of the track to the bucket edge.

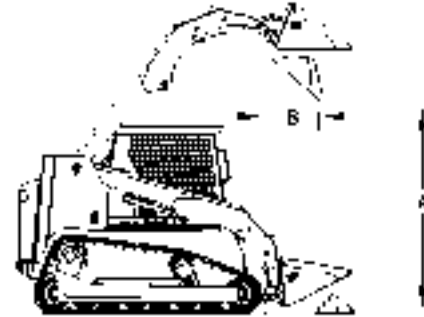

Illustration 14

g00777496

Dimension (A) represents the dump clearance. Dimension (B) represents the reach.

The following tables provide the rated operating capacities (R.O.C) for the standard machine configuration with a bucket.

Table 1

General Purpose Buckets					
	Part Number	165 - 6152	165 - 6153	165 - 6154	199 - 7720
	Width	1524 mm (60 inch)	1676 mm (66 inch)	1828 mm (72 inch)	1981 mm (78 inch)
	Rated Volume	0.36 m ³ (0.40 yd ³)	0.40 m ³ (0.44 yd ³)	0.44 m ³ (0.48 yd ³)	0.48 m ³ (0.53 yd ³)
	Bucket Weight	200 kg (441 lb)	216 kg (476 lb)	224 kg (494 lb)	245 kg (540 lb)
Models					
247	R.O.C 35%	620 kg (1366 lb)	613 kg (1351 lb)	611 kg (1347 lb)	605 kg (1333 lb)
	R.O.C 50%	887 kg (1955 lb)	877 kg (1933 lb)	873 kg (1924 lb)	865 kg (1906 lb)
257	R.O.C 35%	738 kg (1627 lb)	732 kg (1613 lb)	729 kg (1607 lb)	723 kg (1593 lb)
	R.O.C 50%	1055 kg (2325 lb)	1046 kg (2306 lb)	1042 kg (2297 lb)	1034 kg (2279 lb)
267	R.O.C 35%	N/A	N/A	1045 kg (2304 lb)	1036 kg (2284 lb)
	R.O.C 50%	N/A	N/A	1493 kg (3291 lb)	1480 kg (3263 lb)
277	R.O.C 35%	N/A	N/A	1051 kg (2317 lb)	1042 kg (2297 lb)
	R.O.C 50%	N/A	N/A	1501 kg (3309 lb)	1488 kg (3280 lb)
287	R.O.C 35%	N/A	N/A	1148 kg (2530 lb)	1142 kg (2517 lb)
	R.O.C 50%	N/A	N/A	1640 kg (3615 lb)	1631 kg (3595 lb)
247	(B)	737 mm (2.4 ft)	739 mm (2.4 ft)	739 mm (2.4 ft)	741 mm (2.4 ft)
257	(B)	900 mm (3.0 ft)	902 mm (3.0 ft)	903 mm (3.0 ft)	905 mm (3.0 ft)
267 and 277	(B)	N/A	N/A	625 mm (2.1 ft)	625 mm (2.1 ft)
287	(B)	N/A	N/A	988 mm (3.2 ft)	990 mm (3.2 ft)
247	(A)	1935 mm (6.3 ft)	1934 mm (6.3 ft)	1934 mm (6.3 ft)	1933 mm (6.3 ft)
257	(A)	2268 mm (7.4 ft)	2267 mm (7.4 ft)	2266 mm (7.4 ft)	2265 mm (7.4 ft)
267 and 277	(A)	N/A	N/A	2347 mm (7.7 ft)	2347 mm (7.7 ft)
287	(A)	N/A	N/A	2350 mm (7.7 ft)	2349 mm (7.7 ft)

Table 2

Multipurpose Buckets					
	Part Number	154 - 5004	154 - 5008	154 - 5010	199 - 8320
	Width	1524 mm (60 inch)	1676 mm (66 inch)	1829 mm (72 inch)	1981 mm (78 inch)
	Rated Volume	0.30 m ³ (0.33 yd ³)	0.34 m ³ (0.37 yd ³)	0.37 m ³ (0.48 yd ³)	0.40 m ³ (0.44 yd ³)
	Bucket Weight	331 kg (730 lb)	349 kg (769 lb)	368 kg (811 lb)	384 kg (847 lb)
Models					
247	R.O.C 35%	569 kg (1254 lb)	563 kg (1241 lb)	555 kg (1223 lb)	552 kg (1216 lb)
	R.O.C 50%	814 kg (1794 lb)	803 kg (1770 lb)	794 kg (1750 lb)	789 kg (1739 lb)
257	R.O.C 35%	686 kg (1512 lb)	679 kg (1496 lb)	672 kg (1481 lb)	669 kg (1474 lb)
	R.O.C 50%	981 kg (2162 lb)	970 kg (2138 lb)	961 kg (2118 lb)	956 kg (2107 lb)
267	R.O.C 35%	N/A	N/A	986 kg (2174 lb)	979 kg (2158 lb)
	R.O.C 50%	N/A	N/A	1409 kg (3106 lb)	1398 kg (3082 lb)
277	R.O.C 35%	N/A	N/A	992 kg (2187 lb)	984 kg (2169 lb)
	R.O.C 50%	N/A	N/A	1417 kg (3124 lb)	1406 kg (3100 lb)
287	R.O.C 35%	N/A	N/A	1085 kg (2392 lb)	1084 kg (2389 lb)
	R.O.C 50%	N/A	N/A	1550 kg (3417 lb)	1549 kg (3414 lb)
247	(B)	752 mm (2.5 ft)	753 mm (2.5 ft)	755 mm (2.5 ft)	757 mm (2.5 ft)
257	(B)	919 mm (3.0 ft)	922 mm (3.0 ft)	925 mm (3.0 ft)	927 mm (3.0 ft)
267 and 277	(B)	N/A	N/A	628 mm (2.1 ft)	628 mm (2.1 ft)
287	(B)	N/A	N/A	1009 mm (3.3 ft)	1012 mm (3.3 ft)
247	(A)	1922 mm (6.3 ft)	1921 mm (6.3 ft)	1920 mm (6.3 ft)	1919 mm (6.3 ft)
257	(A)	2249 mm (7.4 ft)	2247 mm (7.4 ft)	2245 mm (7.4 ft)	2244 mm (7.4 ft)
267 and 277	(A)	N/A	N/A	2340 mm (7.7 ft)	2340 mm (7.7 ft)
287	(A)	N/A	N/A	2334 mm (7.7 ft)	2299 mm (7.5 ft)

Table 3

Dirt Buckets					
	Part Number	165 - 6155	165 - 6156	165 - 6157	188 - 3526
	Width	1372 mm (54 inch)	1524 mm (60 inch)	1676 mm (66 inch)	1829 mm (72 inch)
	Rated Volume	30 m ³ (33 yd ³)	0.34 m ³ (0.37 yd ³)	0.37 m ³ (0.40 yd ³)	0.41 m ³ (0.45 yd ³)
	Bucket Weight	131 kg (289 lb)	141 kg (311 lb)	166 kg (366 lb)	179 kg (395 lb)
Models					
247	R.O.C 35%	662 kg (1459 lb)	657 kg (1448 lb)	649 kg (1430 lb)	646 kg (1424 lb)
	R.O.C 50%	947 kg (2087 lb)	939 kg (2070 lb)	928 kg (2045 lb)	923 kg (2034 lb)
257	R.O.C 35%	782 kg (1724 lb)	777 kg (1712 lb)	769 kg (1695 lb)	764 kg (1684 lb)
	R.O.C 50%	1118 kg (2464 lb)	1111 kg (2449 lb)	1099 kg (2422 lb)	1092 kg (2407 lb)
267	R.O.C 35%	N/A	N/A	N/A	1086 kg (2394 lb)
	R.O.C 50%	N/A	N/A	N/A	1552 kg (3422 lb)
277	R.O.C 35%	N/A	N/A	N/A	1092 kg (2407 lb)
	R.O.C 50%	N/A	N/A	N/A	1560 kg (3439 lb)
287	R.O.C 35%	N/A	N/A	N/A	1196 kg (2636 lb)
	R.O.C 50%	N/A	N/A	N/A	1709 kg (3767 lb)
247	(B)	692 mm (2.3 ft)	693 mm (2.3 ft)	695 mm (2.3 ft)	697 mm (2.3 ft)
257	(B)	856 mm (2.8 ft)	857 mm (2.8 ft)	860 mm (2.8 ft)	862 mm (2.8 ft)
267 and 277	(B)	N/A	N/A	N/A	586 mm (1.9 ft)
287	(B)	N/A	N/A	N/A	947 mm (3.1 ft)
247	(A)	1974 mm (6.5 ft)	1973 mm (6.5 ft)	1972 mm (6.5 ft)	1971 mm (6.5 ft)
257	(A)	2313 mm (7.6 ft)	2312 mm (7.6 ft)	2310 mm (7.6 ft)	2309 mm (7.6 ft)
267 and 277	(A)	N/A	N/A	N/A	2383 mm (7.8 ft)
287	(A)	N/A	N/A	N/A	2392 mm (7.8 ft)

Table 4

Utility Buckets				
	Part Number	165 - 8835	165 - 8746	165 - 8778
	Width	1524 mm (60 inch)	1676 mm (66 inch)	1829 mm (72 inch)
	Rated Volume	0.42 m ³ (0.46 yd ³)	0.47 m ³ (0.51 yd ³)	0.51 m ³ (0.66 yd ³)
	Bucket Weight	211 kg (465 lb)	226 kg (498 lb)	240 kg (529 lb)
Models				
247	R.O.C 35%	620 kg (1366 lb)	614 kg (1353 lb)	610 kg (1344 lb)
	R.O.C 50%	886 kg (1953 lb)	878 kg (1935 lb)	872 kg (1922 lb)
257	R.O.C 35%	738 kg (1627 lb)	733 kg (1615 lb)	728 kg (1604 lb)
	R.O.C 50%	1055 kg (2325 lb)	1048 kg (2310 lb)	1041 kg (2295 lb)
267	R.O.C 35%	N/A	N/A	1044 kg (2302 lb)
	R.O.C 50%	N/A	N/A	1492 kg (3289 lb)
277	R.O.C 35%	N/A	N/A	1050 kg (2315 lb)
	R.O.C 50%	N/A	N/A	1500 kg (3307 lb)
287	R.O.C 35%	N/A	N/A	1150 kg (2535 lb)
	R.O.C 50%	N/A	N/A	1644 kg (3624 lb)
247	(B)	772 mm (2.5 ft)	775 mm (2.5 ft)	775 mm (2.5 ft)
257	(B)	934 mm (3.0 ft)	936 mm (3.1 ft)	937 mm (3.1 ft)
267 and 277	(B)	N/A	N/A	658 mm (2.2 ft)
287	(B)	N/A	N/A	1023 mm (3.3 ft)
247	(A)	1909 mm (6.3 ft)	1909 mm (6.3 ft)	1908 mm (6.3 ft)
257	(A)	2239 mm (7.3 ft)	2237 mm (7.3 ft)	2236 mm (7.3 ft)
267 and 277	(A)	N/A	N/A	2322 mm (7.6 ft)
287	(A)	N/A	N/A	2321 mm (7.6 ft)

Table 5

Light Material Buckets			
	Part Number	164 - 7416	167 - 7417
	Width	1829 mm (72 inch)	1981 mm (78 inch)
	Rated Volume	0.69 m ³ (0.90 yd ³)	0.75 m ³ (0.98 yd ³)
	Bucket Weight	257 kg (566 lb)	272 kg (600 lb)
Models			
247	R.O.C 35%	644 kg (1419 lb)	639 kg (1408 lb)
	R.O.C 50%	920 kg (2028 lb)	913 kg (2012 lb)
257	R.O.C 35%	767 kg (1690 lb)	762 kg (1679 lb)
	R.O.C 50%	1096 kg (2416 lb)	1089 kg (2400 lb)
267	R.O.C 35%	1093 kg (2410 lb)	1088 kg (2399 lb)
	R.O.C 50%	1562 kg (3444 lb)	1554 kg (3426 lb)
277	R.O.C 35%	1099 kg (2423 lb)	1094 kg (2412 lb)
	R.O.C 50%	1570 kg (3461 lb)	1563 kg (3446 lb)
287	R.O.C 35%	1216 kg (2680 lb)	1210 kg (2667 lb)
	R.O.C 50%	1738 kg (3831 lb)	1729 kg (3811 lb)
247	(B)	809 mm (2.7 ft)	810 mm (2.7 ft)
257	(B)	969 mm (3.2 ft)	972 mm (3.2 ft)
267 and 277	(B)	690 mm (2.3 ft)	690 mm (2.3 ft)
287	(B)	1055 mm (3.5 ft)	1057 mm (3.5 ft)
247	(A)	1880 mm (6.2 ft)	1879 mm (6.2 ft)
257	(A)	2204 mm (7.2 ft)	2202 mm (7.2 ft)
267 and 277	(A)	2294 mm (7.5 ft)	2294 mm (7.5 ft)
287	(A)	2290 mm (7.5 ft)	2289 mm (7.5 ft)

Table 6

Industrial Grapple Buckets⁽¹⁾				
	Part Number	157 - 7223	157 - 7224	157 - 7225
	Width	1524 mm (60 inch)	1676 mm (66 inch)	1829 mm (72 inch)
	Bucket Weight	398 kg (877 lb)	413 kg (910 lb)	427 kg (941 lb)
Models				
247	R.O.C 35%	588 kg (1296 lb)	582 kg (1283 lb)	577 kg (1272 lb)
	R.O.C 50%	840 mm (2.8 ft)	832 mm (2.7 ft)	825 mm (2.7 ft)
257	R.O.C 35%	709 kg (1563 lb)	703 kg (1549 lb)	698 kg (1538 lb)
	R.O.C 50%	1013 kg (2233 lb)	1005 kg (2215 lb)	998 kg (2200 lb)
267	R.O.C 35%	1031 kg (2273 lb)	1026 kg (2262 lb)	1020 kg (2249 lb)
	R.O.C 50%	1473 kg (3247 lb)	1465 kg (3230 lb)	1458 kg (3214 lb)
277	R.O.C 35%	1037 kg (2286 lb)	1031 kg (2273 lb)	1026 kg (2262 lb)
	R.O.C 50%	1481 kg (3265 lb)	1473 kg (3247 lb)	1466 kg (3232 lb)
287	R.O.C 35%	1147 kg (2528 lb)	1142 kg (2517 lb)	1136 kg (2504 lb)
	R.O.C 50%	1639 kg (3613 lb)	1631 kg (3595 lb)	1624 kg (3580 lb)
247	(B)	760 mm (2.5 ft)	762 mm (2.5 ft)	763 mm (2.5 ft)
257	(B)	935 mm (3.0 ft)	937 mm (3.1 ft)	939 mm (3.1 ft)
267 and 277	(B)	628 mm (2.1 ft)	628 mm (2.1 ft)	628 mm (2.1 ft)
287	(B)	1019 mm (3.3 ft)	1021 mm (3.3 ft)	1022 mm (3.4 ft)
247	(A)	1924 mm (6.3 ft)	1924 mm (6.3 ft)	1923 mm (6.3 ft)
257	(A)	2246 mm (7.4 ft)	2245 mm (7.4 ft)	2243 mm (7.4 ft)
267 and 277	(A)	2348 mm (7.7 ft)	2348 mm (7.7 ft)	2348 mm (7.7 ft)
287	(A)	2338 mm (7.7 ft)	2337 mm (7.7 ft)	2336 mm (7.7 ft)

⁽¹⁾ The rated capacity is calculated with a full bucket of dirt. Grasping objects with the grapple will lower the rated capacity.

Table 7

Utility Grapple Buckets ⁽¹⁾			
	Part Number	165 - 8729	165 - 8730
	Width	1676 mm (66 inch)	1829 mm (72 inch)
	Bucket Weight	330 kg (728 lb)	344 kg (758 lb)
Models			
247	R.O.C 35%	583 kg (1285 lb)	578 kg (1274 lb)
	R.O.C 50%	833 kg (1836 lb)	826 kg (1821 lb)
257	R.O.C 35%	701 kg (1545 lb)	696 kg (1534 lb)
	R.O.C 50%	1002 kg (2209 lb)	995 kg (2193 lb)
267	R.O.C 35%	1016 kg (2240 lb)	1012 kg (2231 lb)
	R.O.C 50%	1452 kg (3201 lb)	1445 kg (3186 lb)
277	R.O.C 35%	1022 kg (2253 lb)	1017 kg (2242 lb)
	R.O.C 50%	1460 kg (3219 lb)	1453 kg (3203 lb)
287	R.O.C 35%	1123 kg (2475 lb)	1118 kg (2464 lb)
	R.O.C 50%	1605 kg (3538 lb)	1598 kg (3522 lb)
247	(B)	783 mm (2.6 ft)	785 mm (2.6 ft)
257	(B)	951 mm (3.1 ft)	953 mm (3.1 ft)
267 and 277	(B)	658 mm (2.2 ft)	658 mm (2.2 ft)
287	(B)	1035 mm (3.4 ft)	1037 mm (3.4 ft)
247	(A)	1903 mm (6.2 ft)	1903 mm (6.2 ft)
257	(A)	2226 mm (7.3 ft)	2225 mm (7.3 ft)
267 and 277	(A)	2322 mm (7.6 ft)	2322 mm (7.6 ft)
287	(A)	2315 mm (7.6 ft)	2314 mm (7.6 ft)

Rated Loads for Forks



Failure to comply to the rated load can cause possible personal injury or property damage. Review the rated load of a particular work tool before performing any operation. Make adjustments to the rated load as necessary for non-standard configurations.

Note: Rated loads should be used as a guide. Attachments, uneven ground conditions, soft ground conditions, or poor ground conditions have effects on rated loads. The operator is responsible for being aware of these effects.

The rated operating load is defined by SAE J1197 FEB 91 and EN474. The rated operating load is the least amount of weight of the following conditions:

- 35% of the full static tipping load on a soft, less smooth or level surface or 50% of the full static tipping load on a hard, smooth, level surface
- 100% of the lifting capacity

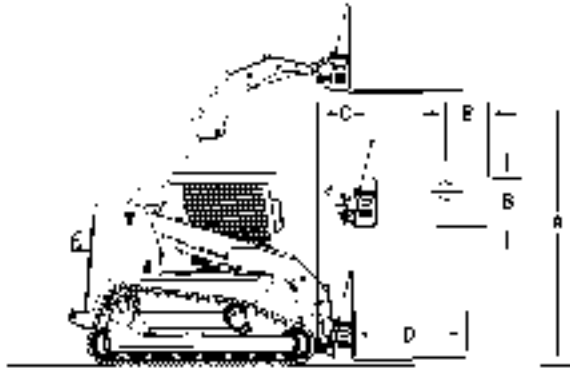

Illustration 15

g00777498

Dimension (A) represents the maximum fork height. Dimension (B) represents the load center. Dimension (C) represents the reach. Dimension (D) represents the fork tine length.

The maximum fork height (ground to top face of fork) is given for a pallet fork that is horizontal at maximum lift height. The reach (front of the tracks to the front face of the fork) is given for a pallet fork that is horizontal maximum reach.

The following tables provide the rated operating capacities (R.O.C) for the standard machine configuration that is equipped with the following items:

- full fuel tank
- 75 kg (165 lb) operator
- Caterpillar fork

Table 8

Rated Operating Load with a Pallet Fork				
	Part Number	151 - 5134	149 - 1412	161 - 2437
	Weight	184 kg (406 lb)	194 kg (428 lb)	203 kg (448 lb)
	(B)	455 mm (18 inch)	535 mm (21 inch)	610 mm (24 inch)
	(D)	910 mm (36 inch)	1070 mm (42 inch)	1220 mm (48 inch)
Models				
247	R.O.C 35%	404 kg (890 lb)	390 kg (859 lb)	377 kg (831 lb)
	R.O.C 50%	577 kg (1272 lb)	557 kg (1227 lb)	539 kg (1188 lb)
257	R.O.C 35%	580 kg (1278 lb)	551 kg (1214 lb)	525 kg (1157 lb)
	R.O.C 50%	829 kg (1827 lb)	787 kg (1735 lb)	751 kg (1655 lb)
267	R.O.C 35%	848 kg (1870 lb)	811 kg (1788 lb)	777 kg (1713 lb)
	R.O.C 50%	1212 kg (2672 lb)	1158 kg (2553 lb)	1111 kg (2449 lb)
277	R.O.C 35%	852 kg (1878 lb)	815 kg (1797 lb)	782 kg (1724 lb)
	R.O.C 50%	1217 kg (2683 lb)	1165 kg (2568 lb)	1118 kg (2465 lb)
287	R.O.C 35%	893 kg (1968 lb)	848 kg (1869 lb)	812 kg (1790 lb)
	R.O.C 50%	1275 kg (2810 lb)	1212 kg (2671 lb)	1161 kg (2559 lb)
247	(B)	917 mm (3.0 ft)	917 mm (3.0 ft)	918 mm (3.0 ft)
257	(B)	1073 mm (3.5 ft)	1073 mm (3.5 ft)	1073 mm (3.5 ft)
267 and 277	(B)	845 mm (2.8 ft)	845 mm (2.8 ft)	845 mm (2.8 ft)
287	(B)	1151 mm (3.8 ft)	1151 mm (3.8 ft)	1151 mm (3.8 ft)
247	(A)	2547 mm (8.4 ft)	2546 mm (8.4 ft)	2545 mm (8.4 ft)
257	(A)	2763 mm (9.0 ft)	2762 mm (9.0 ft)	2762 mm (9.0 ft)
267 and 277	(A)	2987 mm (9.8 ft)	2987 mm (9.8 ft)	2987 mm (9.8 ft)
287	(A)	2855 mm (9.4 ft)	2855 mm (9.4 ft)	2855 mm (9.4 ft)

Table 9

Rated Operating Load with a Utility Fork			
	Part Number	165 - 8732	165 - 8737
	Weight	195 kg (430 lb)	217 kg (478 lb)
	Width	1676 mm (66 inch)	1829 mm (72 inch)
	(B)	314 mm (12 inch)	314 mm (12 inch)
Models			
247	R.O.C 35%	420 kg (925 lb)	414 kg (912 lb)
	R.O.C 50%	600 kg (1322 lb)	592 kg (1305 lb)
257	R.O.C 35%	628 kg (1384 lb)	622 kg (1371 lb)
	R.O.C 50%	897 kg (1977 lb)	889 kg (1959 lb)
267	R.O.C 35%	900 kg (1984 lb)	894 kg (1971 lb)
	R.O.C 50%	1286 kg (2835 lb)	1277 kg (2815 lb)
277	R.O.C 35%	905 kg (1995 lb)	899 kg (1982 lb)
	R.O.C 50%	1293 kg (2851 lb)	1285 kg (2833 lb)
287	R.O.C 35%	976 kg (2151 lb)	967 kg (2131 lb)
	R.O.C 50%	1394 kg (3073 lb)	1381 kg (3044 lb)

Rated Load with a Material Handling Arm



Failure to comply to the rated load can cause possible personal injury or property damage. Review the rated load of a particular work tool before performing any operation. Make adjustments to the rated load as necessary for non-standard configurations.

Note: Rated loads should be used as a guide. Attachments, uneven ground conditions, soft ground conditions, or poor ground conditions have effects on rated loads. The operator is responsible for being aware of these effects.

The maximum placement height (ground line to the chain hook) is given for the highest position of the material handling arm. The maximum reach (front of the machine to the chain hook) is the maximum horizontal reach of the material handling arm.

The rated operating capacity is the least amount of weight of the following conditions:

- 35% of the full static tipping load on a soft, less smooth or level surface or 50% of the full static tipping load on a hard, smooth, level surface
- 100% of the lifting capacity
- The material handling arm has a structural capacity of 907 kg (2000 lb).

The following tables provide the rated operating capacities (R.O.C.) for the standard machine configuration that is equipped with the following items:

- full fuel tank
- 75 kg (165 lb) operator
- Caterpillar Material Handling Arm

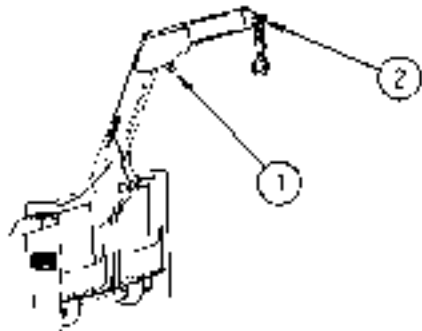

Illustration 16

g00668844

Lifting point 1 (1)

Lifting point 2 (2)

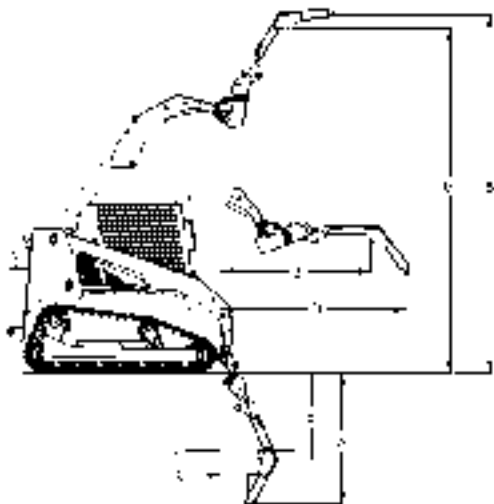

Illustration 17

g00779834

Dimension (A) represents the clearance at the full down position from Lifting Point 2. Dimension (a) represents the clearance at the full down position from Lifting Point 1. Dimension (B) represents the clearance at maximum height from Lifting Point 2. Dimension (b) represents the clearance at maximum height from Lifting Point 1. Dimension (C) represents the minimum reach from Lifting Point 2. Dimension (c) represents the minimum reach from Lifting Point 1. Dimension (D) represents the maximum reach from Lifting Point 2. Dimension (d) represents the maximum reach from Lifting Point 1.

Table 10

Models		Lifting Point 1 (1)	Lifting Point 2 (2)
247	R.O.C	543 kg (1197 lb)	447 kg (985 lb)
	Clearance at Full Down	1119 mm (3.7 ft)	1614 mm (5.3 ft)
	Clearance at Maximum Height	3868 mm (12.7 ft)	4312 mm (14.1 ft)
	Minimum Reach	653 mm (2.1 ft)	535 mm (1.8 ft)
	Maximum Reach	1911 mm (6.3 ft)	2350 mm (7.7 ft)
257	R.O.C	649 kg (1430 lb)	539 kg (1188 lb)
	Clearance at Full Down	946 mm (3.1 ft)	1439 mm (4.7 ft)
	Clearance at Maximum Height	4246 mm (13.9 ft)	4691 mm (15.4 ft)
	Minimum Reach	669 mm (2.2 ft)	547 mm (1.8 ft)
	Maximum Reach	1937 mm (6.4 ft)	2369 mm (7.8 ft)
267	R.O.C	711 kg (1567 lb)	698 kg (1538 lb)
	Clearance at Full Down	970 mm (3.2 ft)	1460 mm (4.8 ft)
	Clearance at Maximum Height	4325 mm (14.2 ft)	4766 mm (15.6 ft)
	Minimum Reach	508 mm (1.7 ft)	369 mm (1.2 ft)
	Maximum Reach	1760 mm (5.8 ft)	2201 mm (7.2 ft)
277	R.O.C	711 kg (1567 lb)	728 kg (1604 lb)
	Clearance at Full Down	970 mm (3.2 ft)	1460 mm (4.8 ft)
	Clearance at Maximum Height	4325 mm (14.2 ft)	4766 mm (15.6 ft)
	Minimum Reach	508 mm (1.7 ft)	369 mm (1.2 ft)
	Maximum Reach	1760 mm (5.8 ft)	2201 mm (7.2 ft)
287	R.O.C	907 kg (1999 lb)	841 kg (1854 lb)
	Clearance at Full Down	991 mm (3.3 ft)	1482 mm (4.9 ft)
	Clearance at Maximum Height	4340 mm (14.2 ft)	4522 mm (14.8 ft)
	Minimum Reach	566 mm (1.9 ft)	436 mm (1.4 ft)
	Maximum Reach	1747 mm (5.7 ft)	2193 mm (7.2 ft)

i01881423

Specifications

SMCS Code: 7000

The specifications that are given herein describe the machine as the machine is manufactured by Caterpillar Inc. The machine is full of fluids. The machine is equipped with all options. The weight does not include the operator, work tools, or other attachments.

Table 11

	247	257	267	277	287
Maximum Machine Weight	3002 kg (6618 lb)	3439 kg (7582 lb)	4089 kg (9015 lb)	4106 kg (9052 lb)	4412 kg (9727 lb)
Overall Length	2701 mm (106 inch)	2701 mm (106 inch)	2923 mm (115 inch)	2923 mm (115 inch)	2901 mm (114 inch)
Height	2022 mm (80 inch)	2022 mm (80 inch)	2074 mm (82 inch)	2074 mm (82 inch)	2123 mm (84 inch)
Width	1676 mm (66 inch)	1676 mm (66 inch)	1974 mm (78 inch)	1974 mm (78 inch)	1962 mm (77 inch)

Identification Information

i01946856

Plate Locations and Film Locations

SMCS Code: 1000; 7000

The Product Identification Number (PIN) will be used to identify a powered machine that is designed for an operator to ride.

Caterpillar products such as engines, transmissions and motorized work tools that are not designed for an operator to ride are identified by Serial Numbers.

For quick reference, record the identification numbers in the spaces that are provided below the illustration.

- Model _____
- Power (kW) _____
- Weight (kg) _____

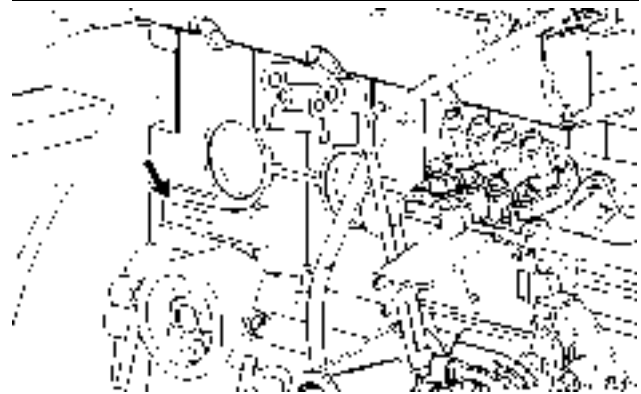

Illustration 20 g00903003

This plate is located on the left side of the engine block.

Engine Serial Number _____

i01830750

Emissions Certification Film

SMCS Code: 1000; 7000; 7405

Note: This information is pertinent in the United States, in Canada and in Europe.

A typical example is shown.

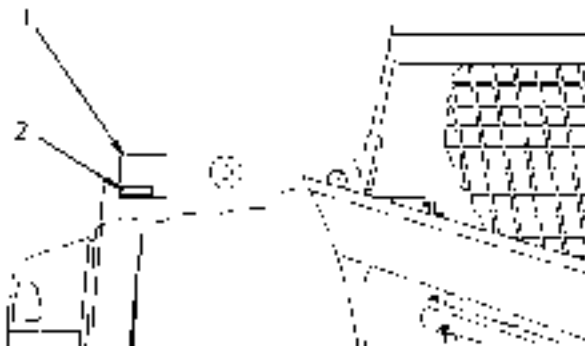

Illustration 18 g00902931
247, 267, and **277**

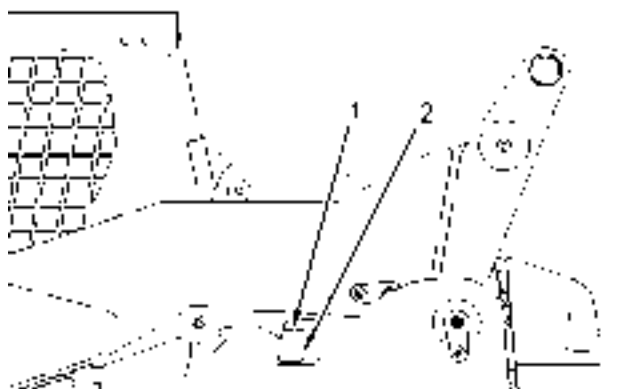

Illustration 19 g00902975
257 and 287

(1) Machine PIN _____

(2) CE Plate

- PIN _____

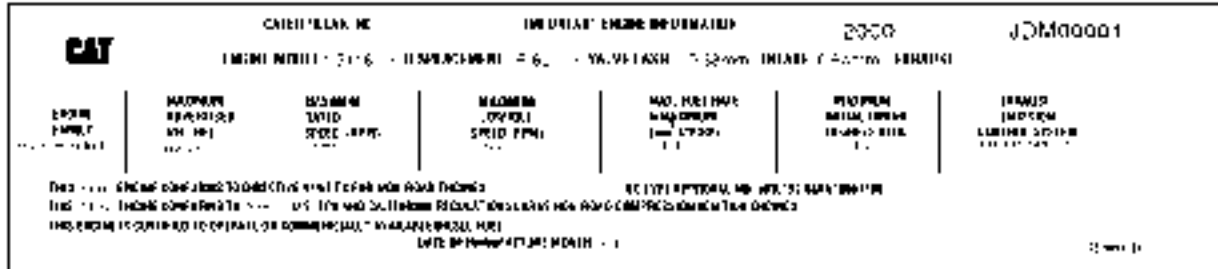
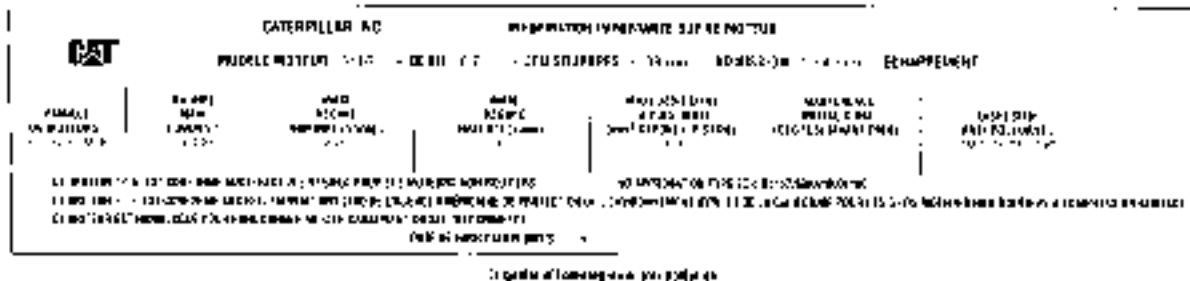

FIG. 2540

The EPA/EU Emissions Certification label (if applicable) is located either on the side, the top, or the front of the engine.



L'autocollant d'homologation du dispositif antipollution EPA/EU (selon équipement) est situé soit sur le côté du moteur, soit sur le dessus du moteur, soit sur le devant du moteur.

Illustration 21

Operation Section

i01946878

Before Operation

Mounting and Dismounting

i02189821

SMCS Code: 7000



Illustration 22
Typical example

g00037860

Mount the machine and dismount the machine only at locations that have steps and/or handholds. Before you mount the machine, clean the steps and the handholds. Inspect the steps and handholds. Make all necessary repairs.

Face the machine whenever you get on the machine and whenever you get off the machine.

Maintain a three-point contact with the steps and with the handholds.

Note: Three-point contact can be two feet and one hand. Three-point contact can also be one foot and two hands.

Do not mount a moving machine. Do not dismount a moving machine. Never jump off the machine. Do not carry tools or supplies when you try to mount the machine or when you try to dismount the machine. Use a hand line to pull equipment onto the platform. Do not use any controls as handholds when you enter the operator compartment or when you exit the operator compartment.

Alternate Exit

Machines that are equipped with cabs have alternate exits. For additional information, see Operation and Maintenance Manual, "Alternate Exit".

Daily Inspection

SMCS Code: 1000; 7000

NOTICE

Accumulated grease and oil on a machine is a fire hazard. Remove this debris with steam cleaning or high pressure water, at least every 1000 hours or each time any significant quantity of oil is spilled on a machine.

Note: For maximum service life of the machine, make a thorough daily inspection before you operate the machine. Inspect the machine for leaks. Remove any debris from the engine compartment and the undercarriage. Ensure that all guards, covers, and caps are secured. Inspect all hoses and belts for damage. Make the needed repairs before you operate the machine.

Perform the following procedures on a daily basis.

- Operation and Maintenance Manual, "Engine Oil Level - Check"
- Operation and Maintenance Manual, "Cooling System Level - Check"
- Operation and Maintenance Manual, "Radiator Core - Clean"
- Operation and Maintenance Manual, "Hydraulic System Oil Level - Check"
- Operation and Maintenance Manual, "Engine Air Filter Service Indicator - Inspect"
- Operation and Maintenance Manual, "Fuel System Water Separator - Drain"
- Operation and Maintenance Manual, "Axle Bearings - Lubricate"
- Operation and Maintenance Manual, "Lift Arm and Cylinder Linkage - Lubricate"
- Operation and Maintenance Manual, "Seat Belt - Inspect"
- Operation and Maintenance Manual, "Tilt Cylinder Bearings and Bucket Linkage Bearings - Lubricate"
- Operation and Maintenance Manual, "Bogie and Idler - Inspect/Replace"
- Operation and Maintenance Manual, "Sprocket Retaining Nuts - Check"
- Operation and Maintenance Manual, "Track (Rubber) - Inspect/Replace"

-
- Operation and Maintenance Manual, “Quick Coupler - Inspect/Adjust”
 - Operation and Maintenance Manual, “Work Tool Mounting Bracket - Inspect”
 - Operation and Maintenance Manual, “Backup Alarm - Test”

Refer to the Maintenance Section for the detailed procedures. Refer to the Maintenance Interval Schedule for a complete list of scheduled maintenance.

Refer to the following service interval charts and service intervals for additional maintenance information.

267 and 277 Service Interval Chart

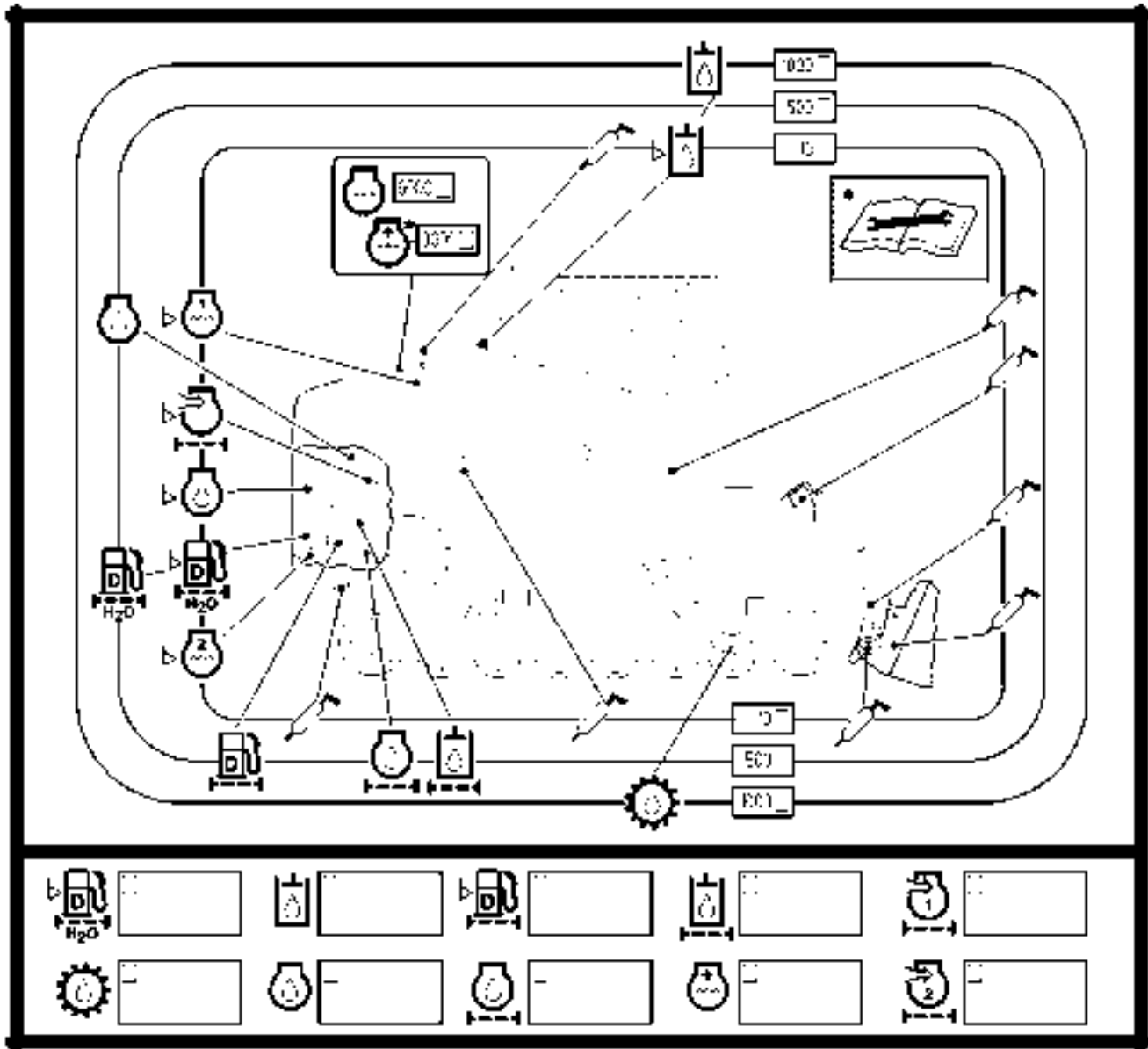

Illustration 25

g00785614

Service Intervals



Engine air filter primary element – Clean the primary air filter element or replace the primary air filter element. The air filter service indicator indicates when servicing is necessary.



Engine air filter secondary element – Replace the secondary air filter element with every third change of the primary air filter element or replace the secondary air filter element when it is necessary.



Grease zerk – Lubricate the designated locations after every ten service hours or at the end of each day.



Hydraulic oil level check – Check the hydraulic oil level at the sight gauge after every ten service hours or at the end of each day.



Engine oil level check – Check the engine oil level after every ten service hours or at the end of each day.



Fuel system water separator – Drain the water separator after every ten service hours or at the end of each day.



Coolant level (radiator) – Check the coolant level in the radiator at the sight gauge after every ten service hours or at the end of each day.



Coolant level (reservoir) – Check the coolant level in the coolant reservoir after every ten service hours or at the end of each day.



Engine Air Filter Service Indicator – Check the indicator after every ten service hours or at the end of each day.



Engine oil – Change the engine oil after every 500 service hours or every three months.



Fuel System Water Separator Element – Replace the fuel system water separator element after every 500 service hours or every three months.



Engine oil filter – Change the engine oil filter after every 500 service hours or every three months.



Hydraulic oil filter – Change the hydraulic oil filter after every 500 service hours or every three months.



Diesel fuel filter – Change the fuel filter after every 500 service hours or every three months.



Hydraulic oil – Change the hydraulic oil after every 1000 service hours or one time per year.



Coolant additive – Add the extender to the extended life coolant after every 3000 service hours or every 2 years.



Cooling system coolant – Change the ELC (Extended Life Coolant) after every 6000 hours or every 4 years.



Bogie oil level check and Idler oil level check – Check the oil level in the Bogie wheel tubes and the Idler wheel tubes after every 1000 hours or every year.

Machine Operation

i01822242

Alternate Exit

i01850883

SMCS Code: 7000

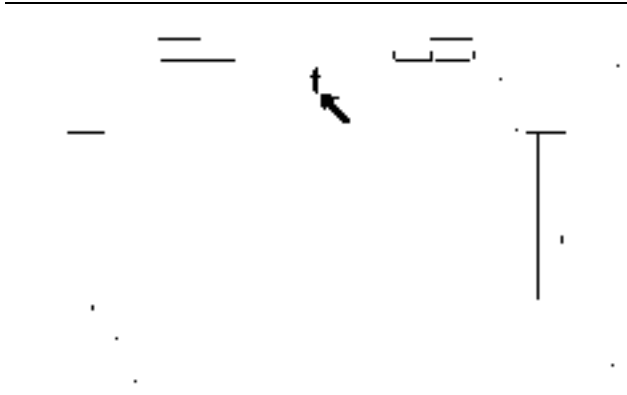

Illustration 26

g00929616

The opening in the rear of the machine serves as an alternate exit. The window (if equipped) will need to be removed in order to use the alternate exit.

The window can be removed by pulling on the ring at the top of the window. This will remove the seal that holds the window in place. When the seal is taken out, carefully remove the window.

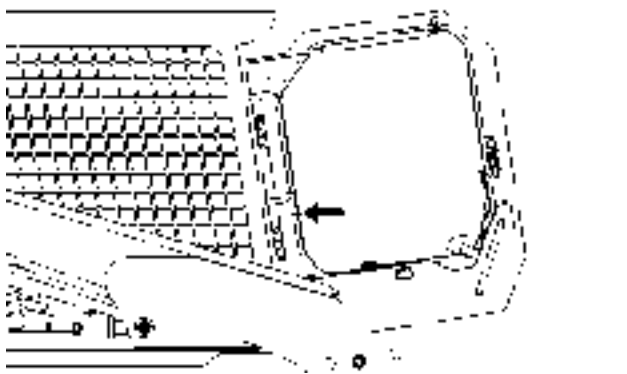

Illustration 27

g00929624

If the machine is equipped with a cab door, the opening in the door may serve as an alternate exit. The window will need to be removed in order to use the alternate exit.

The window can be removed by pulling on the ring on the left side of the window. This will remove the seal that holds the window in place. When the seal is taken out, carefully remove the window.

Seat Belt

SMCS Code: 7327

Note: This machine was equipped with a seat belt when the machine was shipped from Caterpillar. At the time of installation, the seat belt and the instructions for installation of the seat belt meet the SAE J386 standards. See your Caterpillar dealer for all replacement parts.

Always check the condition of the seat belt and the condition of the mounting hardware before you operate the machine.

Seat Belt Adjustment for Non-Retractable Seat Belts

Adjust both ends of the seat belt. The seat belt should be snug but comfortable.

Lengthening the Seat Belt



Illustration 28

g00100709

1. Unfasten the seat belt.



Illustration 29

g00932817

2. To remove the slack in outer loop (1), rotate buckle (2). This will free the lock bar. This permits the seat belt to move through the buckle.
3. Remove the slack from the outer belt loop by pulling on the buckle.
4. Loosen the other half of the seat belt in the same manner. If the seat belt does not fit snugly with the buckle in the center, readjust the seat belt.

Shortening the Seat Belt



Illustration 30

g00100713

1. Fasten the seat belt. Pull out on the outer belt loop in order to tighten the seat belt.
2. Adjust the other half of the seat belt in the same manner.
3. If the seat belt does not fit snugly with the buckle in the center, readjust the seat belt.

Fastening The Seat Belt



Illustration 31

g00932818

Fasten the seat belt catch (3) into the buckle (2). Make sure that the seat belt is placed low across the lap of the operator.

Releasing The Seat Belt

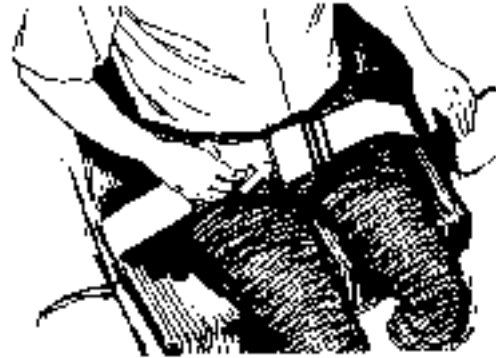

Illustration 32

g00100717

Pull up on the release lever. This will release the seat belt.

Seat Belt Adjustment for Retractable Seat Belts

Fastening The Seat Belt



Illustration 33

g00867598

Pull seat belt (4) out of the retractor in a continuous motion.

Fasten seat belt catch (3) into buckle (2). Make sure that the seat belt is placed low across the lap of the operator.

The retractor will adjust the belt length and the retractor will lock in place. The comfort ride sleeve will allow the operator to have limited movement.

Releasing The Seat Belt

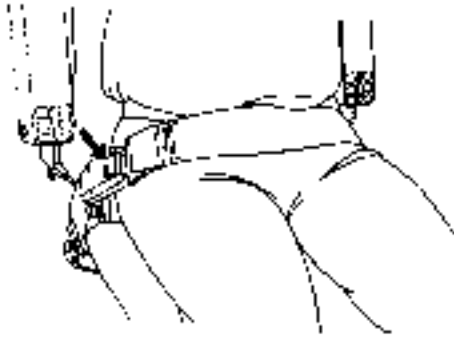

Illustration 34

g00039113

Push the release button on the buckle in order to release the seat belt. The seat belt will automatically retract into the retractor.

Extension of the Seat Belt



When using retractable seat belts, do not use seat belt extensions, or personal injury or death can result.

The retractor system may or may not lock up depending on the length of the extension and the size of the person. If the retractor does not lock up, the seat belt will not retain the person.

Longer, non-retractable seat belts and extensions for the non-retractable seat belts are available.

Caterpillar requires only non-retractable seat belts to be used with a seat belt extension.

Consult your Caterpillar dealer for longer seat belts and for information on extending the seat belts.

i02406630

Operator Controls

SMCS Code: 7300; 7451

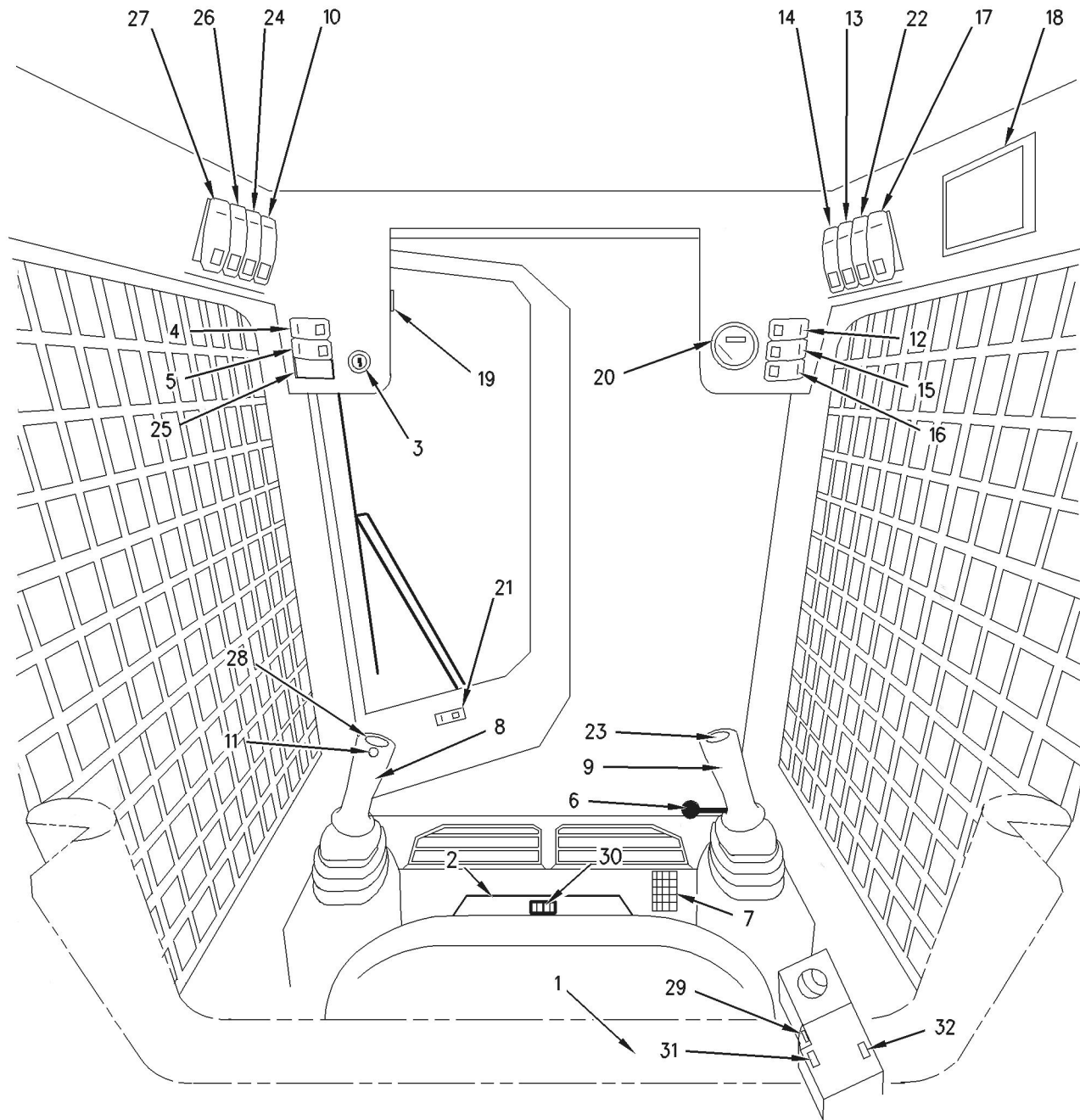

Illustration 35

g01005547

- | | | |
|--|---|---|
| <ul style="list-style-type: none"> (1) Interlock Control (2) Seat Adjustment (3) Engine Start Switch (4) Glow Plug Starting Aid (5) Parking Brake Control (6) Governor Control (7) Accelerator Control (8) Speed and Direction Control (9) Work Tool Control (10) Work Tool Coupler Control (11) Horn | <ul style="list-style-type: none"> (12) Turn Signals (13) Hazard Flashers (14) Roading Lights (15) Front Work Lights (16) Rear Work Lights (17) Beacon Switch (18) Cab Dome Light (19) Service Hour Meter (20) Fuel Level Gauge (21) Window Wiper and Window Washer (22) Hydraulic Shutoff Control | <ul style="list-style-type: none"> (23) Auxiliary Hydraulic Control (24) Auxiliary Electrical Control (25) Plugged (26) Automatic Level Control (27) Continuous Flow and Interlock Override (28) Rear Auxiliary Hydraulic Control or Fourth Function Control (29) Temperature Control (30) Suspension Seat (31) Fan Speed Control (32) Air Conditioning Control |
|--|---|---|

Interlock Control (1)

Interlock Control – Move the armrest to the RAISED position in order to lock out the hydraulic controls.

Note: When the armrest is moved to the RAISED position, the parking brake will engage. Move the armrest to the LOWERED position and push the switch for the parking brake in order to activate the hydraulic controls.

Note: When you start the engine, the parking brake must be disengaged in order for the hydraulic controls to be activated. If the armrest is raised and then lowered during operation, you must disengage the parking brake in order for the hydraulic controls to be activated.

Seat Adjustment (2)



Seat Adjustment

Engine Start Switch (3)



OFF – Insert the engine start switch key only from the OFF position and remove the engine start switch key only from the OFF position. Turn the engine start switch key to the OFF position in order to stop the engine. In the OFF position, there is no power to most electrical circuits on the machine. The cab lights, panel lights, tail lights, working lights (if equipped) and fuel gauge light are operational even when the engine start switch is in the OFF position.



ON – Turn the engine start switch key clockwise to the ON position in order to activate all of the cab circuits.



START – Turn the engine start switch key clockwise to the START position in order to crank the engine. Release the engine start switch key after the engine starts and the engine start switch key returns to the ON position.

Note: If the engine fails to start, the engine start switch key must be returned to the OFF position in order to attempt to start the engine again.

Glow Plug Starting Aid (4)



Glow Plug Starting Aid – Refer to Operation and Maintenance Manual, “Engine Starting” for the starting procedure with glow plugs.

Parking Brake Control (5)



Parking Brake Control – Press on the right side of the switch in order to engage or disengage the parking brake.

Note: The parking brake will engage when the engine is stopped. The parking brake will engage when the armrest is moved to the RAISED position. The parking brake will engage when the operator leaves the operator seat for an extended period of time.

Governor Control (6)

Governor Control – Use the governor control when you want to set a constant engine speed. Move the lever forward in order to increase engine speed. Move the lever backward in order to decrease engine speed.



High Idle



Low Idle

Accelerator Control (7)



Accelerator Control – Push down on the accelerator pedal in order to increase engine speed. Release the accelerator pedal in order to decrease engine speed. The accelerator pedal will return to the setting of the governor control.

Speed and Direction Control (8)

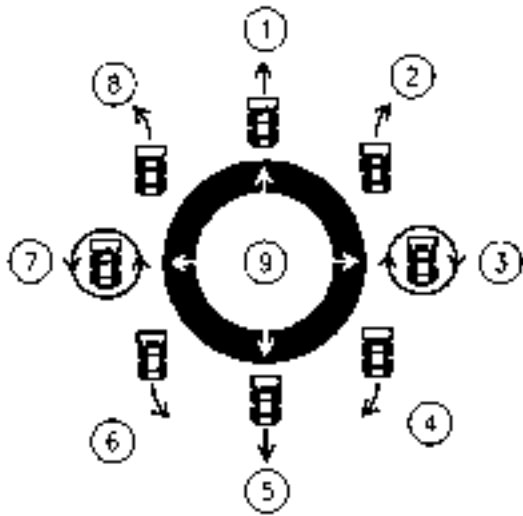

Illustration 36

g00741590

- (1) FORWARD
- (2) RIGHT TURN
- (3) RIGHT SPOT TURN
- (4) REVERSE LEFT TURN
- (5) REVERSE
- (6) REVERSE RIGHT TURN
- (7) LEFT SPOT TURN
- (8) LEFT TURN
- (9) HOLD

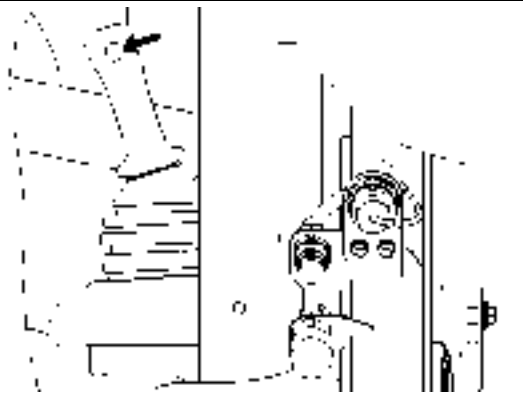

Illustration 37

g00897879

Two Speed – Press the switch on the front of the joystick in order to activate rabbit mode.

Note: Keep the work tool close to the ground when you travel in rabbit mode. This will maximize the stability of the machine.

Note: The backup alarm will sound when you travel in reverse.

When you release the joystick from any position, the joystick will return to the HOLD position (9). The machine will stop moving when the joystick is in the HOLD position.

Work Tool Control (9)

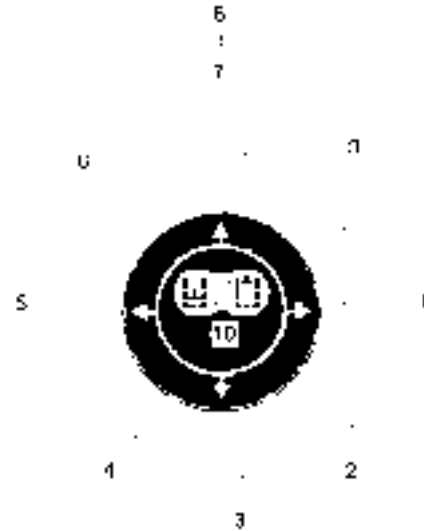

Illustration 38

g01080546

- (1) TILT FORWARD
- (2) TILT FORWARD and RAISE
- (3) RAISE
- (4) TILT BACK and RAISE
- (5) TILT BACK
- (6) TILT BACK and LOWER
- (7) LOWER
- (8) FLOAT
- (9) TILT FORWARD and LOWER
- (10) HOLD

When you release the joystick the joystick will return to the HOLD position (9). The work tool and loader arms will stop moving when the joystick is in the HOLD position.

Note: If the joystick is in the FLOAT detent, the joystick must be pulled out of the FLOAT position in order for the joystick to return to the HOLD position.

Work Tool Coupler Control (10)



Improper attachment of work tools could result in injury or death.

Do not operate this machine until you have positive indication that the coupler pins are fully engaged. Check for engagement by:

1. Tilt the work tool down.
2. Put downward pressure on the work tool.
3. Back the machine up and make sure there is not any movement between the work tool and the quick coupler assembly.

Work Tool Coupler Control (If Equipped) – The work tool coupler control controls the engagement of the coupler pins.



Disengaged – Pull the red button downward and press the bottom of the switch. Hold the switch in the downward position until the coupler pins disengage.



Engaged – Press the top of the switch and hold the top of the switch until the coupler pins engage.

Horn (11)



Horn (If Equipped) – Press on the button in order to sound the horn.

Turn Signals (12)



Turn Signals (If Equipped) – Press on the left side of the switch in order to turn on the left turn signals. Press on the right side of the switch in order to turn on the right turn signals. Move the switch to the middle position in order to turn off the turn signals.

Hazard Flashers (13)



Hazard Flashers Control (If Equipped) – Press on the top of the switch in order to activate the hazard flashers. Press on the bottom of the switch in order to deactivate the hazard flashers.

Roading Lights (14)



Roading Lights (If Equipped) – Move the switch to the middle position in order to turn on the control panel lights and position lights. Press on the bottom of the switch in order to turn on the front low beams. Press on the top of the switch in order to turn off the lights.

Front Work Lights (15)



Front Work Lights (If Equipped) – Press the left side of the switch in order to turn on the lights. Press the right side of the switch in order to turn off the lights.

Rear Work Lights (16)



Rear Work Lights (If Equipped) – Press the left side of the switch in order to turn on the lights. Press the right side of the switch in order to turn off the lights.

Beacon Switch (17)

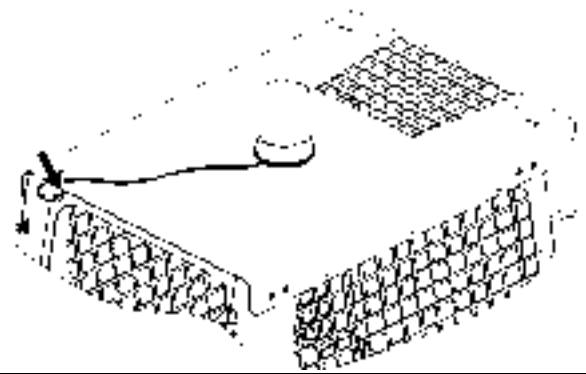

Illustration 39

g00897909



Beacon (If Equipped) – Press on the bottom of the switch in order to turn on the beacon. Press the top of the switch in order to turn off the beacon. The receptacle for the beacon is located on the upper left corner on the rear of the cab.

Cab Dome Light (18)



Cab Dome Light – Press on either side of the light in order to turn on the light. Move the light to the middle position in order to turn off the light.

Service Hour Meter (19)



Service Hour Meter – The service hour meter should be used to determine service hour maintenance intervals.

Fuel Level Gauge (20)



Fuel Level Gauge – The needle in the yellow range indicates low fuel.

Window Wiper and Window Washer (21)



Window Wiper and Window Washer (If Equipped) – Move the switch to the middle position in order to turn on the wiper. Press on the right side of the switch in order to operate the washer. Press on the left side of the switch in order to turn off the wipers.

Hydraulic Shutoff Control (22)

Note: Activate the hydraulic shutoff control when you are roading the machine.

WARNING

Personal injury or death can result from the work tool falling.

Fully lower the loader arms before you release the hydraulic system pressure.



Hydraulic Shutoff Control – Press on the bottom of the switch in order to disable the hydraulic functions. Press the top of the switch in order to activate the hydraulic functions.

Auxiliary Hydraulic Control (23)

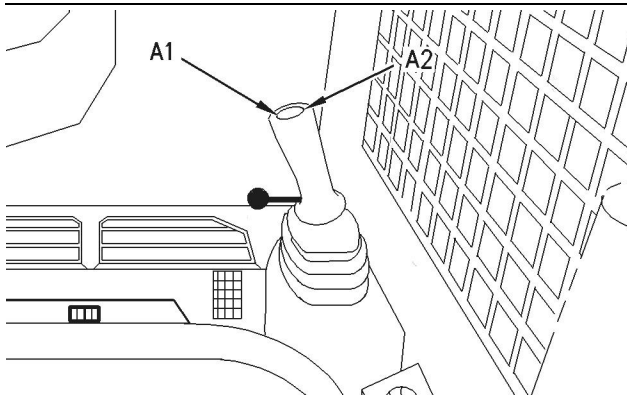

Illustration 40

g00902853

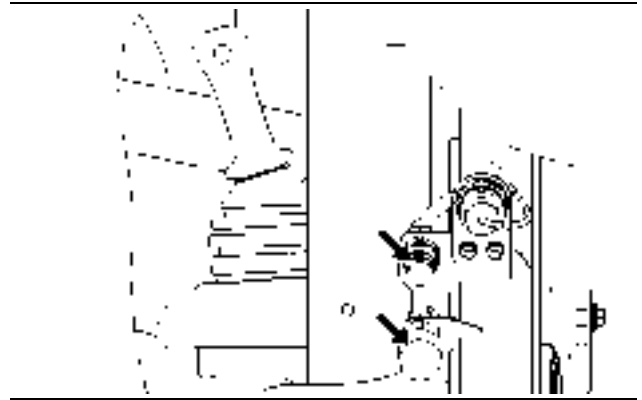

Illustration 41

g00902862

Note: Simple hydromechanical work tools may be shipped without hydraulic oil. Uneven movement may occur until all the air has been removed from the work tool. You may need to add hydraulic oil to the machine after the machine fills the circuits of the work tool. Refer to Operation and Maintenance Manual, “Hydraulic System Oil Level - Check” for the proper procedure for checking the hydraulic oil level.

Auxiliary Hydraulic Control – Press the left side of the auxiliary hydraulic control (A1) in order to provide hydraulic oil flow to the lower auxiliary hydraulic line. Press the right side of the auxiliary hydraulic control (A2) in order to provide hydraulic oil flow to the upper auxiliary hydraulic line. The machine may be equipped with a auxiliary hydraulic control that is proportional. On machines that are equipped with a proportional control, hydraulic flow will vary with the amount of pressure that is applied to auxiliary hydraulic control.

Auxiliary Electrical Control (24)

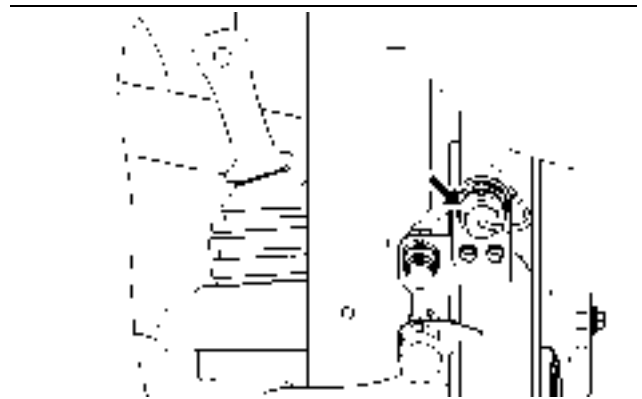

Illustration 42

g00897773



Auxiliary Electrical Control (If Equipped) – The auxiliary electrical control supplies continuous electrical power to the electrical harness that is located on the loader arm. Press on the bottom of the switch in order to turn on electrical power. Press on the top of the switch in order to turn off electrical power.

Plugged (25)

This space is not used on the machine. This space may be used for future functions.

Automatic Level Control (26)



Automatic Level Control (If Equipped) – The Automatic Level Control maintains the selected angle of the work tool as the loader lift arms are raised. Press on the bottom of the switch in order to activate the automatic level control. Press on the top of the switch in order to deactivate the automatic level control.

Continuous Flow and Interlock Override (27)

Machines that are equipped with Continuous Flow and Interlock Override will support both functions on one switch. Your machine may be equipped with a switch that only supports the Interlock Override function.



Continuous Flow (If Equipped) – The continuous flow control supplies continuous flow of hydraulic fluid to the auxiliary hydraulic circuit without continuously holding the auxiliary hydraulic control. Press on either side of the auxiliary hydraulic control. Press on the bottom of the continuous flow switch and release the continuous flow switch. Immediately release the auxiliary hydraulic control after you release the continuous flow switch. The continuous flow function will not be activated if the operator does not release the auxiliary hydraulic control within one second of releasing the continuous flow switch. Press on either the auxiliary hydraulic control or the continuous flow switch in order to stop the flow to the auxiliary circuit.



Interlock Override (If Equipped) – The interlock override function allows the auxiliary hydraulic circuits to function with the armrest in the RAISED position. First activate the continuous flow function. If the machine is equipped with a single function switch then press the bottom of the switch in order to activate the interlock override. If the machine is equipped with a dual function switch then press the top of the switch in order to activate the interlock override function. In order to turn off the interlock override function and continuous flow function, press either side of the auxiliary hydraulic switch or Interlock Override switch.

NOTICE

Do not leave the machine unattended while you have the interlock override function activated.

Rear Auxiliary Hydraulic Control or Fourth Function Control (28)

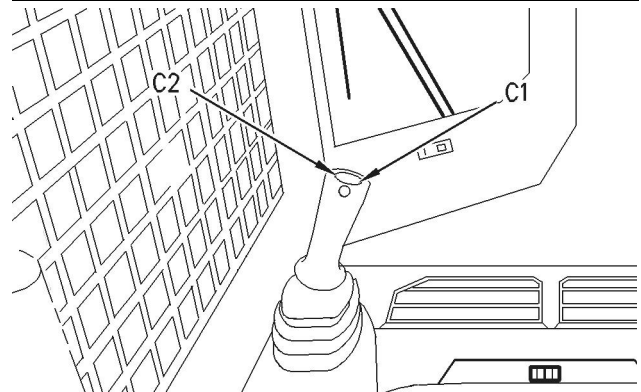

Illustration 43

g00902830

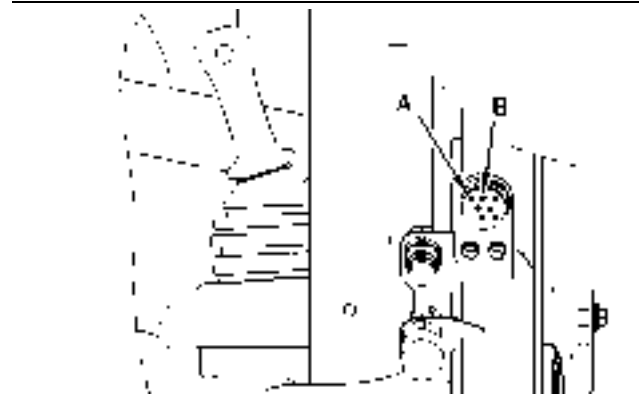

Illustration 44

g00902834

Fourth Function Control (If Equipped) – The fourth function control provides electrical power in order to control a three-position diverter valve that is located on some work tools. Press the right side of the switch (C1) in order to send power to the pin (A). Press the left side of the switch (C2) in order to send power to pin (B).

Rear Auxiliary Hydraulic Control (If Equipped) – In order to activate the rear auxiliary hydraulics, activate the continuous flow function for the front auxiliary hydraulics. Press the left side of the switch in order to direct flow to the lower rear hydraulic line. Press the right side of the switch in order to direct flow to the upper rear hydraulic line.

Temperature Control (29)



Temperature Control (If Equipped)

Suspension Seat (30)



Suspension Seat (If Equipped)

Fan Speed Control (31)



Fan Speed Control

Air Conditioner Control (32)



Air Conditioner Control (If Equipped)

Machine Security System (If Equipped)

NOTICE

This machine is equipped with a Caterpillar Machine Security System (MSS) and may not start under certain conditions. Read the following information and know your machine's settings. Your Caterpillar Dealer can identify your machine settings.



Machine Security System (MSS) – Machines that are equipped with a Caterpillar Machine Security System (MSS) can be identified by a decal in the operator station. MSS is designed to prevent theft of the machine or unauthorized operation.

Basic Operation

MSS may be programmed to read a standard Caterpillar key or an electronic key. The electronic key contains an electronic chip within the plastic housing for the key. Each key emits a unique signal to the MSS. The keys can be identified by a gray housing or a yellow housing. MSS can have programmed settings to require an electronic key or a standard Caterpillar key for starting during certain periods of time.

When the key start switch of the machine is turned to the ON position, the ECM will read the unique ID that is stored in the electronic key. The ECM will then compare this ID to the list of authorized keys. The following table tells the operator the status for starting the machine. The status light is located near the key start switch.

Table 12

Green light	The machine will start.
Red light	The key is not authorized.

Note: MSS will not shut down the machine after the machine has started.

Security Management

The MSS has the capability to allow you to program the system to automatically activate at different time periods with different keys. The MSS can also be programmed to reject a specific electronic key after a selected date and time. When you turn the key to the OFF position and the MSS is active, you have a 30 second interval in order to restart the machine with an unauthorized key. Also if the machine stalls, there is a 30 second interval for restarting the machine. This 30 second interval is counted from the time of turning the key to the OFF position.

Note: Know your machine's settings because the use of an electronic key is no guarantee that the machine can be restarted.

An expiration date can be set for each electronic key that is contained in the list of keys for the machine. The key will no longer start the machine when the internal clock in the security system passes the expiration date. Each entry in the list of keys can have a different expiration date.

Spare keys are available from your dealer. Before a key can operate the machine, the MSS must be set to accept that particular key. Contact your Caterpillar dealer for information on additional features of the MSS.

i01635456

Alert Indicators

SMCS Code: 7450; 7451

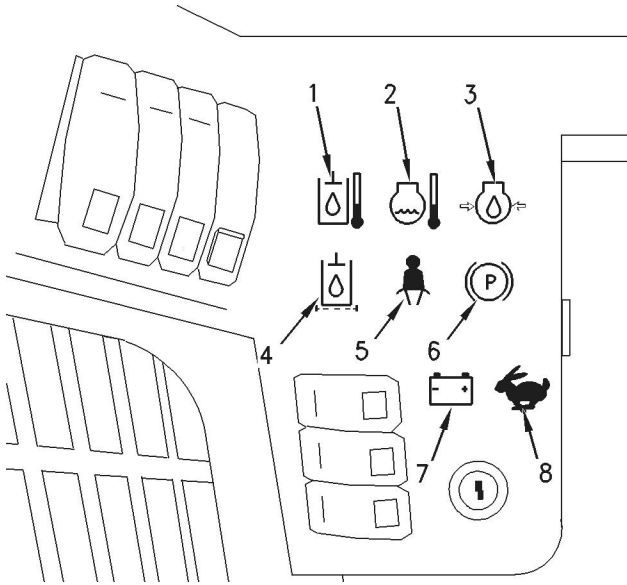

Illustration 45

g00846559



Hydraulic Oil Temperature (1) – The alert indicator will light and an audible alert will sound when the temperature of the hydraulic oil is too high. If this indicator comes on, stop the machine immediately. Stop the engine and investigate the problem.



Engine Coolant (2) – The alert indicator will light and an audible alert will sound when the engine coolant temperature is too high. If this alert indicator comes on, stop the machine immediately. Stop the engine and investigate the cause.



Engine Oil Pressure (3) – The alert indicator will light and an audible alert will sound when the engine oil pressure is low. If this alert indicator comes on, stop the machine immediately. Stop the engine and investigate the cause.



Hydraulic Oil Filter (4) – The indicator will light when the hydraulic oil filter is not functioning properly. Stop the machine and replace the oil filter. The indicator will stay on until the hydraulic oil has warmed up. Do not operate the machine until the light turns off.



Seat and Armrest (5) – The alert indicator will light when the armrest is in the RAISED position. The alert indicator will light when the operator gets out of the operator seat. The alert indicator should go out when the operator is in the operator seat and the armrest is in the LOWERED position.



Parking Brake (6) – The alert indicator will light when the parking brake is engaged. The alert indicator should come on during start-up. The alert indicator should go out when the parking brake is disengaged.



Charging System (7) – The alert indicator will light if there is a malfunction in the electrical system. If this alert indicator comes on, the system voltage is too high for normal machine operation or too low for normal machine operation.

If electrical loads are high and the engine speed is near low idle, increase the engine speed to high idle. This will generate more output from the alternator. If the alert indicator for the electrical system turns off within one minute, the electrical system is probably operating in a normal manner. However, the electrical system may be overloaded during periods of low engine speeds.

Increase the engine idle speed with the governor lever in order to compensate for a higher electrical load on the system.

If this procedure does not cause the alert indicator to turn off, move to a convenient location. Investigate the cause (loose alternator belt, broken alternator belt, faulty batteries, etc).



Rabbit Mode (8) (If Equipped) – The alert indicator will light when rabbit mode is selected with the two-speed control.

Engine Starting

i02404494

Engine Starting

SMCS Code: 1000; 7000

WARNING

Do not use aerosol types of starting aids such as ether. Such use could result in an explosion and personal injury.

It is important to prepare the machine for operation in temperatures that are below 0 °C (32 °F). It is also important to follow the appropriate warm up procedures when the machine is operated in temperatures that are below 0 °C (32 °F).

Machine preparation for cold weather includes using the correct hydraulic system oil. The factory fills the hydraulic system with 10W hydraulic oil which has a minimum operating temperature of -20 °C (-4 °F). If the machine will be operated at temperatures below -20 °C (-4 °F), the 10W oil must be replaced with 0W30 hydraulic oil in order to provide the proper oil viscosity. Refer to Operation and Maintenance Manual, "Lubricant Viscosities and Refill Capacities". Refer to Operation and Maintenance Manual, SEBU5898, "Cold Weather Recommendations for Caterpillar Machines". Refer to Operation and Maintenance Manual, SEBU6250, "Caterpillar Machine Fluids Recommendations".

NOTICE

Keep the engine speed low until the engine oil pressure alert indicator goes out. If the alert indicator does not go out within ten seconds, stop the engine and investigate the cause before starting again. Failure to do so can cause engine damage.

NOTICE

If the engine does not start within fifteen seconds, disengage the starter. Release the glow plug switch if it is being used. Wait for ten seconds and repeat the procedure.

NOTICE

If you fail to follow the steps described below, damage to the engine or damage to the hydraulic system may occur.

1. Fasten the seat belt.
2. Pull the armrest downward.

3. Move the governor control lever or the accelerator pedal to half throttle.
4. Turn the engine start switch key to the START position in order to start the engine. Release the key after the engine has started.

Note: If you are starting the engine below 0 °C (32 °F), turn the engine start switch key to the ON position and press the glow plug switch. Hold the switch for ten seconds and then turn the key to the START position. After the engine starts, continue to press the glow plug switch until the engine runs smoothly.

NOTICE

Do not operate the glow plugs for more than 30 seconds at one time. Damage to the glow plugs could occur.

5. Disengage the parking brake.
6. Run the engine for 5 minutes before performing the following procedure. Run the engine at half throttle. Hold the work tool control in the TILT BACK position for thirty seconds. Release the control for thirty seconds. Hold the work tool control in the LOWER position for thirty seconds. Release the control for thirty seconds. Perform the procedure for three minutes.

Note: If you are operating the machine below 0 °C (32 °F), perform the procedure for eight minutes.

NOTICE

Do not use the hydraulic interlock override function to warm up the machine.

7. Keep all personnel away from the machine. Move the machine very slowly to an open area. Repeat Step 6 as you move the machine back and forth for 3 m (10 ft).

Note: More warm up time may be required if the hydraulic functions are sluggish.

Operation

Operation Information

i02121219

SMCS Code: 7000

General Information

1. Adjust the operator's seat.
2. Fasten the seat belt.
3. Lower the armrest.
4. Start the engine and allow the machine to warm up. Refer to Operation and Maintenance Manual, "Engine Starting".
5. Disengage the parking brake.

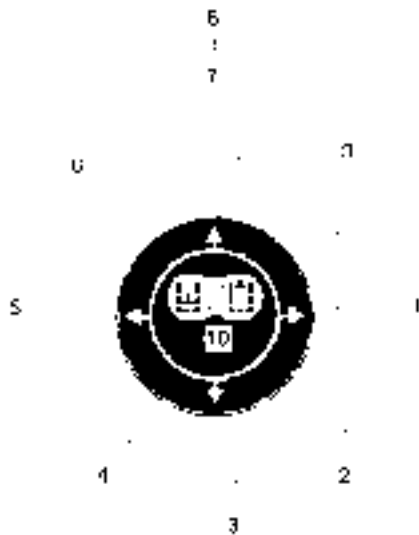

Illustration 46

g01080546

- (1) TILT FORWARD
- (2) TILT FORWARD AND RAISE
- (3) RAISE
- (4) TILT BACK AND RAISE
- (5) TILT BACK
- (6) TILT BACK AND LOWER
- (7) LOWER
- (8) FLOAT
- (9) TILT FORWARD AND LOWER
- (10) HOLD

6. Raise all lowered work tools and attachments in order to negotiate any obstacles.

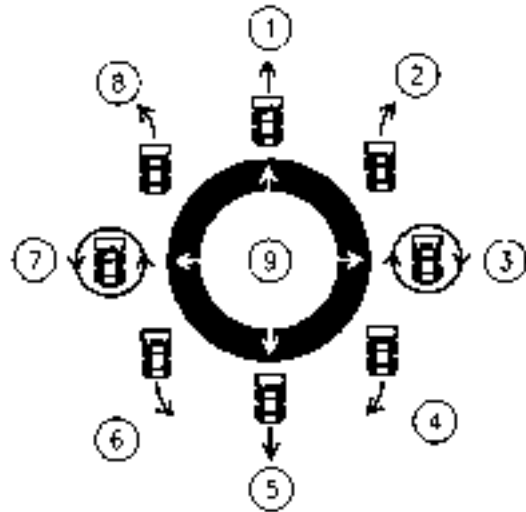

Illustration 47

g00741590

- (1) FORWARD
- (2) RIGHT TURN
- (3) RIGHT SPOT TURN
- (4) REVERSE LEFT TURN
- (5) REVERSE
- (6) REVERSE RIGHT TURN
- (7) LEFT SPOT TURN
- (8) LEFT TURN
- (9) HOLD

7. Smoothly move the speed and direction control for the desired direction and speed.

To prevent injury, make sure that no people are working on the machine or near the machine. To prevent injury, keep the machine under control at all times.

Do not allow the machine to overspeed when you go downhill. Move the speed/direction control lever toward the HOLD position in order to reduce the speed of the machine when you are going downhill. For additional information, refer to Operation and Maintenance Manual, "Operating on a Slope".

Always put the heaviest end of the machine uphill when you are working on an incline.

The loader arms of the machine should be fully lowered onto the stops when you are digging with the machine. Digging with the loader arms in the fully lowered position will transfer the stress that is placed on the loader arm into the frame.

NOTICE

The use of this machine in certain applications can cause premature failure of the rubber tracks and rubber wheels. Applications that may cause premature failure of the rubber tracks and rubber wheels include: use in rocky terrain, use in gravel, use in concrete demolition, use in terrain where metal debris is present, and any application that would require a solid tire on a skid steer loader. Damage to the rubber tracks and rubber wheels that is caused from using the machine in these conditions is not covered under warranty.

Avoid any situation that causes the tracks of the machine to spin on the ground. Avoid spinning the tracks. This will extend the life of the track.

Operating on a Slope

Never exceed a slope that is greater than 3 to 1 (18.4°).

When it is possible, avoid operating the machine across a slope. When it is possible, operate the machine up a slope and down a slope. Do not turn the machine while you are operating on a slope.

NOTICE

When it is necessary to operate the machine on a slope, keep bucket loads light in order to decrease the possibility of derailing the tracks.

NOTICE

If the correct method for turning is not followed, the tracks may derail.

When it is necessary to travel across a slope, the following steps should always be followed:



Illustration 48

g00802153

1. Stop the machine. Turn the machine slowly while you are backing down the slope.

Note: Do not back up a hill in order to turn.

2. Position the machine so that the front of the machine faces the direction for travel that is desired.

Operating on a Transition

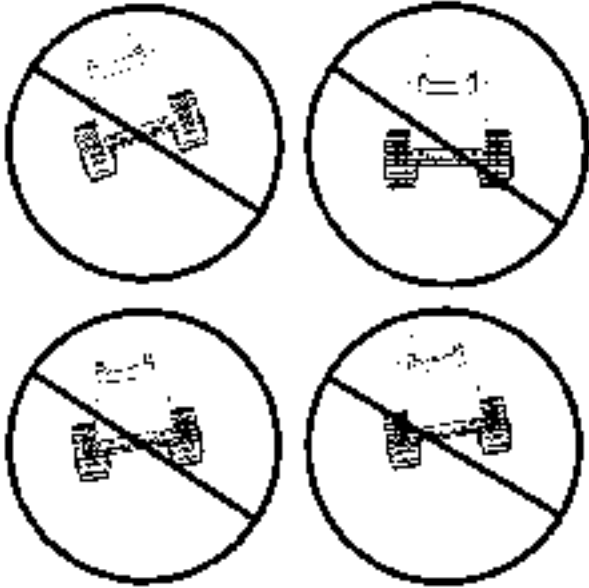

Illustration 49

g00803882

NOTICE

Avoid operating this machine on transitions. Operating this machine on transitions may cause the tracks to derail.

When the machine is operated on a transition, the tracks may not be supported fully.

When the tracks are not supported fully, the wheels may ride on top of the drive lugs of the tracks. The track will derail if you continue to travel on the transition.

If you must travel on a transition, travel the machine at 90° to the transition. Do not perform hard turns or fast turns when you are operating the machine on the transition.

Track Guides



Illustration 50

g00929633

Track Guides are available for the 267 and 277 machines only. The use of track guides on the 267 and 277 machines will minimize the risk of derailing the tracks on a transition or a slope. **Track guides should not be used as a substitute for proper machine operation. Even if track guides are installed, the machine should not be operated on slopes that are greater than 3 to 1 (18.4°).**

Track guides are installed on the undercarriage frame. The track guides work in the following manner. When a track starts to derail the track will contact the guide. The track will start to climb on top of the guide. If the operator continues to run the machine in the same direction, the drive motor for the track will stall. At this point, the operator can reverse the direction of the machine and the track will go back into position.

The life of the tracks and the bogies will be reduced if the tracks are derailed against the track guides. Any wear or damage to the tracks, the bogies or the undercarriage components that is caused by derailing the tracks is not warrantable.

Track guides will wear with use. Track guides that are worn may damage the tracks. Damage to the tracks that results from worn track guides is not warrantable. Replace the track guides as it is necessary.

Contact your local Caterpillar dealer for the correct installation procedure. Refer to Special Instruction, REHS1199, "Installation Procedure for the Multi Terrain Loader Track Guide".

i01935351

Work Tool Coupler Operation

SMCS Code: 6129; 7000

WARNING

Improper attachment of work tools could result in injury or death.

Do not operate this machine until you have positive indication that the coupler pins are fully engaged. Check for engagement by:

1. Tilt the work tool down.
2. Put down pressure on the work tool.
3. Back the machine up and make sure there is not any movement between the work tool and the quick coupler assembly.

Attaching the Work Tool

Note: Before you install the work tool, inspect the coupler and the work tool mounting bracket for any wear or for any damage. Refer to Operation and Maintenance Manual, "Quick Coupler Assembly - Inspect" and Operation and Maintenance Manual, "Work Tool Mounting Bracket - Inspect" for inspection procedures.

1. Position the work tool on a level surface. Move the hydraulic lines (if equipped) for the work tool and electrical lines (if equipped) away from the work tool mounting bracket.

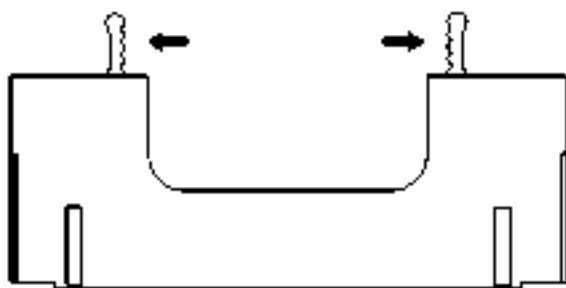

Illustration 51

g00929776

2. If the machine is equipped with a manual coupler, ensure that the levers for the coupler are in the DISENGAGED position. If the machine is equipped with a hydraulic quick coupler refer to Operation and Maintenance Manual, "Work Tool Coupler Operation" for details on disengaging the coupler pins.
3. Enter the machine.
4. Fasten the seat belt and lower the armrest.
5. Start the engine.
6. Disengage the parking brake.
7. Tilt the quick coupler assembly forward.

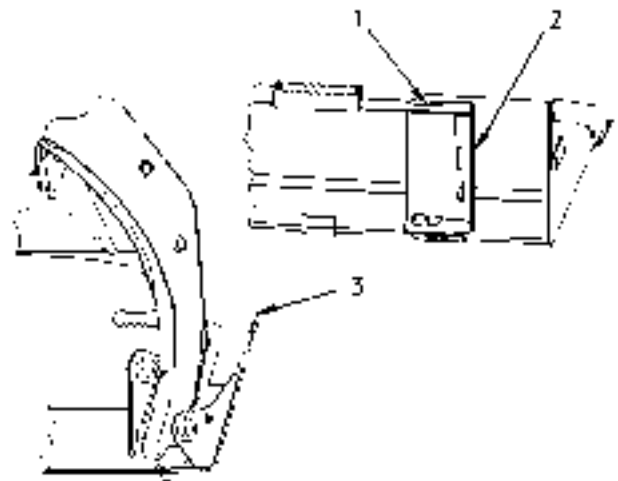

Illustration 52

g00929878

8. Align the quick coupler assembly (3) between the outer plates (2) of the mounting bracket. Move the quick coupler assembly under the angled plate (1) of the mounting bracket and rack back the work tool.
9. Fully lower the loader arms.
10. Tilt the work tool forward until the work tool is slightly off the ground.
11. Turn the engine start switch key to the OFF position in order to stop the engine.
12. If the work tool requires hydraulics, refer to the section "Releasing the Hydraulic System Pressure".
13. Exit the machine.

Note: If you are installing a material handling arm that is not equipped with the optional center step, do not exit the machine. A second person needs to perform steps 14 through step 16.

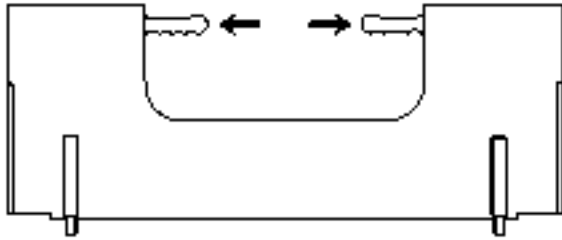

Illustration 53

g00929831

14. If the machine is equipped with a manual coupler, ensure that the levers for the coupler are in the ENGAGED position. If the machine is equipped with a hydraulic quick coupler refer to Operation and Maintenance Manual, "Work Tool Coupler Operation" for details on engaging the coupler pins.

15. If the work tool requires hydraulics, then use the following procedure.

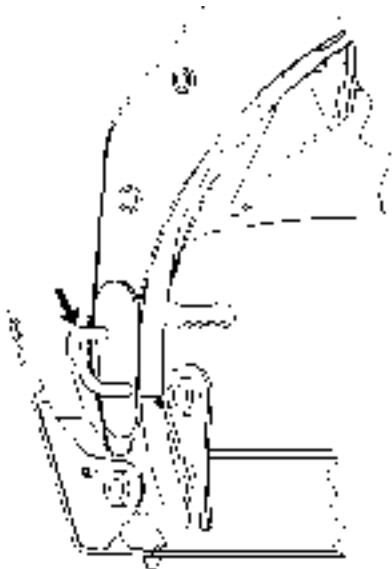

Illustration 54

g00929874

- a. Route the hydraulic hoses through the hose guide on the machine in order to prevent damage to the hoses. Not all work tools require the hydraulic hoses to be routed through the hose guide. The work tool Owner's Manual will inform you if the hydraulic hoses need to be routed through the hose guide. The Caterpillar simple hydromechanical work tools require the hoses to be routed through the hose guide.
- b. Ensure that the quick connect couplers are clean.
- c. Connect the auxiliary hydraulic hoses for the work tool to the machine. Twist the collar of the quick connect coupler for one quarter of a turn in order to secure the hydraulic connections.
- d. If the work tool is equipped with electrical lines, then route the electrical lines with the hydraulic hoses.

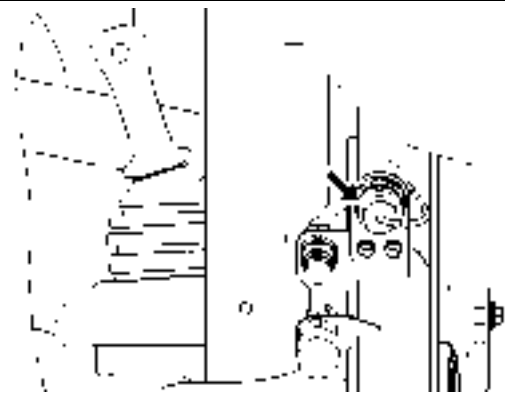

Illustration 55

g00897773

- e. Connect the wire harness (if equipped) to the electrical connector on the machine.
- f. Connect the water line (if equipped) to the electrical connector for the water line on the machine.

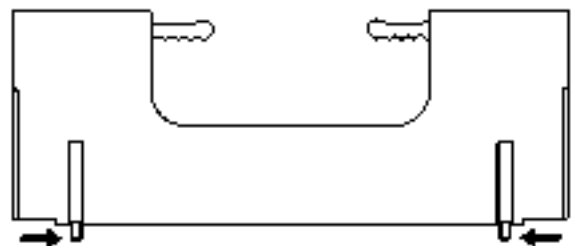

Illustration 56

g00929897

16. Visually ensure that both coupler pins are extending out of the holes in the work tool mounting bracket.
17. Use the following procedure to verify engagement of the coupler pins.
 - a. Enter the machine.
 - b. Fasten the seat belt and lower the armrest.
 - c. Start the engine.
 - d. Disengage the parking brake.
 - e. Keep the work tool close to the ground.
 - f. Activate the tilt control in order to tilt the work tool downward.
 - g. Apply down pressure on the work tool.

Note: The work tool Owner's Manual will inform you if forward pressure should not be applied on a work tool.

- h. Move the machine backward. Ensure that there is no movement between the work tool and the quick coupler assembly.
18. Test the work tool for leaks and for proper operation.

Removing the Work Tool

WARNING

Disengaging the coupler pins will release the work tool from control of the operator.

Serious injury or death may result from disengaging the work tool when it is in an unstable position or carrying a load.

Place the work tool in a safe position before disengaging the coupler pins.

NOTICE

Auxiliary hoses for work tools must be disconnected before the quick coupler is disengaged.

Pulling the work tool with the auxiliary hoses could result in damage to the host machine or the work tool.

1. Position the machine on level ground.
2. Lower the work tool to the ground.

3. Rack back the work tool until the work tool is slightly off the ground.
4. Turn the engine start switch key to the OFF position in order to stop the engine.
5. If the work tool requires hydraulics, refer to the section "Releasing the Hydraulic System Pressure".
6. Perform Step 7 through Step 12 only after you have released the hydraulic system pressure.
7. Disconnect the auxiliary hydraulic hoses from the machine.

Note: If protective caps are available, install protective caps over the quick connect couplers.

8. If hoses are routed through the hose guide, remove the hoses from the hose guide. Move the hoses to a position that is away from the work tool mounting bracket.

Note: Connect the hoses for the work tool together. Connecting the hoses together will reduce the probability of contaminating the hydraulic system. Connecting the hoses together will reduce the buildup of pressure in the hoses. Connecting the hoses together will ease the connection of the hoses to the machine.

9. If the work tool is equipped with an electrical line, then disconnect the wire harness from the connector on the machine. If protective caps are available, install protective caps over the electrical connectors.
10. If the auxiliary electrical line is routed through the hose guide, remove the line from the hose guide. Move the auxiliary electrical line to a position that is away from the work tool mounting bracket.
11. If the work tool is equipped with a water line, then disconnect the water line from the connector on the machine. Move the water line to a position that is away from the work tool mounting bracket.

12. Exit the machine.

Note: If you are removing a material handling arm that is not equipped with an optional center step, do not exit the machine. A second person needs to perform step 13.

13. If the machine is equipped with a manual coupler, ensure that the levers for the coupler are in the DISENGAGED position. If the machine is equipped with a hydraulic quick coupler refer to Operation and Maintenance Manual, "Work Tool Coupler Operation" for details on disengaging the coupler pins.
14. Enter the machine.
15. Fasten the seat belt and lower the armrest.
16. Start the engine.
17. Disengage the parking brake.
18. As you slowly back away from the mounting bracket, tilt the quick coupler assembly forward until the top of the quick coupler assembly clears the angled plate.
19. Back away from the work tool.

Releasing the Hydraulic System Pressure

NOTICE

If the work tool is equipped with an Owner's Manual, follow the procedure that is described in the Owner's Manual for that work tool. Damage to the work tool and the machine may occur if you do not follow the proper installation procedure.

3. Press each side of the auxiliary hydraulic control switch (A1 and A2) for one to two seconds in order to release the auxiliary system pressure. Keep the joystick control in the NEUTRAL position while you press the auxiliary hydraulic control switch (A1 and A2).
4. Engage the parking brake.
5. Start the engine and run the engine for at least 15 seconds in order to recharge the accumulator.
6. Stop the engine.
7. Immediately turn the engine start switch key to the ON position. Disengage the parking brake.
8. Move both of the joystick controls through all of the operating positions in order to release the hydraulic pressure in the work tool system and the hydrostatic system.
9. Turn the engine start switch key to the OFF position.

The pressure in the hydraulic system has now been released.

i01964204

Material Handling Arm Operation

SMCS Code: 6400; 6700; 7000



Illustration 57

g00902862

Auxiliary quick connectors

1. Turn the engine start switch to the OFF position. Do not raise the armrest.
2. Immediately turn the engine start switch key to the ON position. Do not start the engine. Disengage the parking brake.

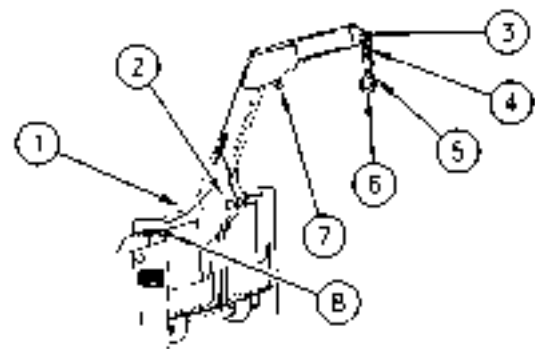

Illustration 58

g00674640

- (1) Location of Optional Center Step
- (2) Tie-Down Point
- (3) Lifting Point 2
- (4) Shackle
- (5) Hook Clasp
- (6) Hook
- (7) Lifting Point 1
- (8) Stored location of Position Lock Pin

Inspect the material handling arm and the attachments for wear and damage. Ensure that the load is properly attached to the material handling arm before you operate the machine.

Note: The physical size and the weight of the load determines the lifting point that is appropriate. Whenever it is possible, use the lifting point 1. This will improve the stability and this will reduce the movement of the load. Refer to the Operation and Maintenance Manual, "Material Handling Arm Rated Load" for the limitations on the weight.

Note: Use only Caterpillar 9V-2714 Hook and Caterpillar 9V-2715 Shackle to attach a load to the material handling arm. Never use an open hook. Use a line that is rated for 2.5 times the weight of the load.

WARNING

Do not allow anyone to be near a suspended load unless the position lock pin is installed. If the lift arms must be raised to handle a tall load, do not allow anyone to be near the suspended load unless the lift arms are blocked. Failure to follow the instructions or heed the warnings could result in injury or death.

Two Person Operation

Attaching A Load

1. Verify that the load does not exceed the weight limit. Refer to the Operation and Maintenance Manual, "Material Handling Arm Rated Load" for the rated load capacities.
2. Keep all personnel out of the work area at all times, except when you are attaching or removing a load.
3. Enter the machine. Start the engine.
4. Disengage the parking brake.

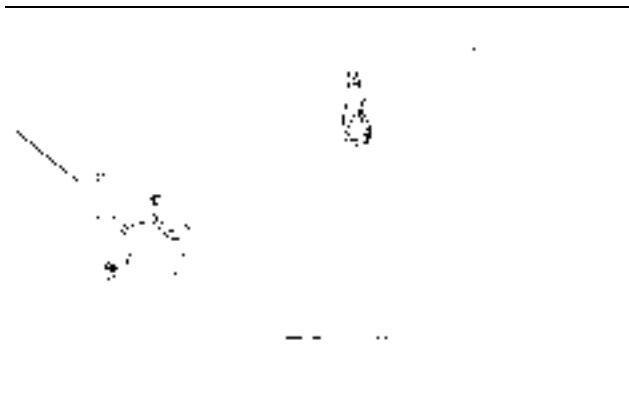

Illustration 59

g01020534

5. Keep the loader arms in the fully lowered position. Slowly position the material handling arm until either lifting point 1 or the lifting point 2 is directly above the load.
6. Tilt the material handling arm forward until the hook is slightly higher than the load in order to minimize swinging of the load.
7. Stop the engine.
8. Wait as the second person attaches the load securely to the hook. The second person needs to ensure that the hook clasp is in the locked position.
9. Ensure that ALL personnel have left the work area.
10. Start the engine.
11. Disengage the parking brake.
12. Slowly tilt back the material handling arm until the material handling arm is fully tilted back.
13. Stop the engine.



Illustration 60

g01020535

14. Wait as the second person installs the position lock pin through the hole in the material handling arm and the hole in the loader arm of the machine.

Note: This will prevent the material handling arm from tilting forward.

15. Wait as the second person secures the load to the tie-down points with a suitable line in order to minimize load swing.

Note: Do not move the load when you are securing the load. Do not pull the load toward the material handling arm when you are securing the load to the tie-down points.

16. Wait as the second person removes the position lock pin. Wait as the second person places the pin in the STORED position on the material handling arm.

Removing a Load

1. Slowly tilt back the material handling arm until the material handling arm is fully tilted back. Lower the loader arms fully.
2. Stop the engine.
3. Wait as the second person installs the position lock pin through the hole in the material handling arm and the hole in the loader arm of the machine.
4. Wait as the second person removes the line that secures the load to the tie-down points.
5. Wait as the second person removes the position lock pin. Wait as the second person places the pin in the STORED position on the material handling arm.
6. Remove all personnel from the work area.
7. Start the engine.
8. Disengage the parking brake.
9. Lower the load to the ground.
10. Stop the engine.
11. Wait as the second person removes the load from the hook.
12. Remove all personnel from the work area.
13. Start the engine.
14. Disengage the parking brake.
15. Slowly tilt back the material handling arm until the material handling arm is fully tilted back.
16. Back away from the load.

One Person Operation

Note: The material handling arm must be equipped with a center step in order to do the one person operation.

Attaching the Load

1. Verify that the load does not exceed the weight limit. Refer to the Operation and Maintenance Manual, "Material Handling Arm Rated Load" for the rated load capacities.
2. Keep all personnel out of the work area at all times, except when you are attaching or removing a load.
3. Enter the machine. Start the engine.
4. Disengage the parking brake.



Illustration 61

g01020534

5. Keep the loader arms in the fully lowered position. Slowly position the material handling arm until either lifting point 1 or lifting point 2 is directly above the load.
6. Tilt the material handling arm forward until the hook is slightly higher than the load in order to minimize swinging of the load.
7. Stop the engine. Exit the machine.
8. Attach the load securely to the hook. Ensure that the hook clasp is in the LOCKED position.
9. Keep all personnel out of the work area.
10. Enter the machine. Start the engine.
11. Disengage the parking brake.
12. Slowly tilt back the material handling arm until the material handling arm is fully tilted back.
13. Stop the engine. Exit the machine.

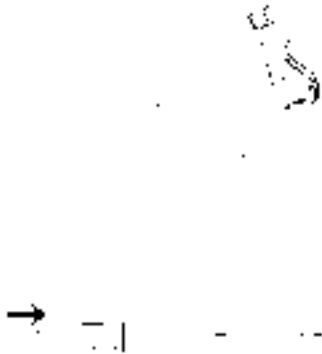

Illustration 62

g01020535

14. Install the position lock pin through the hole in the material handling arm and the hole in the loader arm of the machine.

15. Secure the load to the tie-down points with a suitable line in order to minimize load swing.

Note: Do not move the load when you are securing the load. Do not pull the load toward the material handling arm when you are securing the load to the tie-down points.

16. Remove the position lock pin and place the pin in the STORED position on the material handling arm.

Removing a Load

1. Fully tilt back the material handling arm. Fully lower the loader arms.
2. Stop the engine. Exit the machine.
3. Install the position lock pin through the hole in the loader arm of the machine.
4. Remove the line that secures the load to the tie-down points .
5. Remove the position lock pin and place the pin in the STORED position on the material handling arm.
6. Keep all personnel out of the work area.
7. Enter the machine. Start the engine.
8. Disengage the parking brake.

9. Lower the load to the ground.

10. Stop the engine. Exit the machine.

Note: Make sure that the load is stable.

11. Remove the load from the hook.

12. Keep all personnel out of the work area.

13. Enter the machine. Start the engine.

14. Disengage the parking brake.

15. Slowly tilt back the material handling arm until the material handling arm is fully tilted back.

16. Back away from the load.

Traveling with a Load

1. Ensure that all personnel have left the work area.
2. Start the engine.
3. Disengage the parking brake.
4. Raise the load so that the load is slightly off of the ground.
5. Slowly travel to the destination. Keep the load as close to the ground as possible. Travel up slopes with the load uphill. Travel down slopes with the load uphill. Do not travel across slopes.

i01878348

Pallet Forks Operation

SMCS Code: 6700; 7000

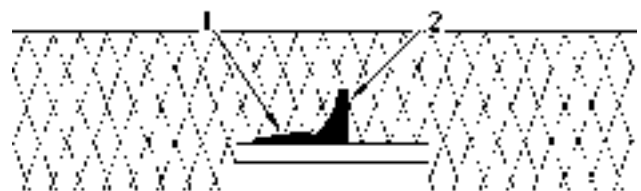

Illustration 63

g00955937

The "type 1" pin that is in the unlocked position (2) and the locked position (1).

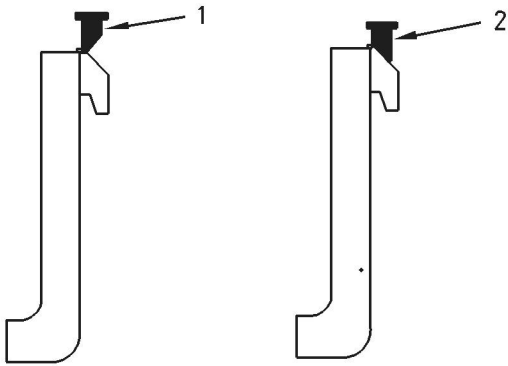

Illustration 64 g00955964

The "type 2" pin that is in the unlocked position (1) and the locked position (2).

1. Put the fork tines in the Unlocked position. Space the fork tines as far as possible from each other.
2. Put the fork tines in the Locked position.
3. Slowly, move the machine into position and engage the load. The machine should be square with the load. Space the forks evenly between the pallet stringers.
4. Move the machine forward until the load contacts the carriage.
5. Lift the load carefully.
6. Slowly, move the machine in reverse until the load is clear enough to lower.
7. Carefully lower the load while you tilt the forks back to the travel position.

Travel with the load as low as possible while you still maintain ground clearance.

Travel with the load uphill on upgrades and on downgrades.

i01871947

Work Tool Operation

SMCS Code: 6700; 7000

The following tables describe the functionality of the Auxiliary Hydraulic Control and the functionality of the Fourth Function Control when you operate the machine with approved Caterpillar hydromechanical work tools.

While you operate the machine and the work tool slowly in an open area, check for proper operation of all controls and all protective devices on the machine and the work tool.

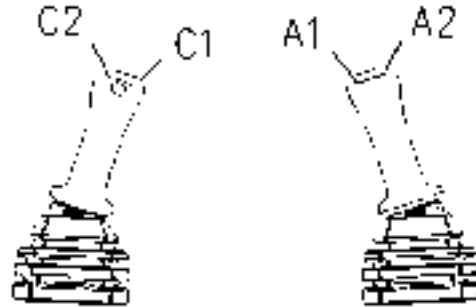

Illustration 65 g00793391

joystick for the fourth function control (C1 and C2) and joystick for the auxiliary hydraulic control (A1 and A2)

Note: For standard flow machines, use the A2 function in order to supply hydraulic oil flow to the work tools that require continuous flow.

Table 13

OPERATION OF CATERPILLAR SIMPLE HYDROMECHANICAL WORK TOOLS					
Work Tool	Position of Fourth Function Control		Position of Auxiliary Hydraulic Control		Results
	C2	C1	A1	A2	
Multipurpose Bucket	N/A ⁽¹⁾		X		The bucket will close.
				X	The bucket will open.
Industrial Grapple Bucket and Utility Grapple Bucket	N/A		X		The grapple will close.
				X	The grapple will open.
Angle Blade	N/A		X		The blade will angle to the left.
				X	The blade will angle to the right.

⁽¹⁾ The control is not applicable.

Table 14

OPERATION OF CATERPILLAR COMPLEX HYDROMECHANICAL WORK TOOLS					
Work Tool	Position of Fourth Function Control		Position of Auxiliary Hydraulic Control		Results
	C2	C1	A1	A2	
A13 Auger and A19 Auger	N/A ⁽¹⁾			X	The auger bit rotates clockwise when you view the auger from the motor end.
			X		The auger bit rotates counterclockwise when you view the auger from the motor end.
BA18 Angle Broom				X	The broom rotates clockwise when you view the left side of the broom.
	X			X	The broom head articulates to the left while the broom rotates. This operation is not applicable to an angle broom with manual angling.
		X		X	The broom head articulates to the right while the broom rotates. This operation is not applicable to an angle broom with manual angling.
BP15 Pickup Broom and BP18 Pickup Broom	N/A			X	The broom rotates clockwise when you view the left side of the broom.
CV16 Vibratory Compactor and CV18 Vibratory Compactor	N/A			X	The eccentric shaft rotates counterclockwise when you view the left side of the vibratory compactor.
			X		The eccentric shaft rotates clockwise when you view the left side of the vibratory compactor.
LR15 Landscape Rake and LR18 Landscape Rake	N/A			X	The rake cover opens.
			X		The conveyor rotates counterclockwise when you view the left side of the landscape rake. If the rake cover is open, the rake cover will close.
LT13 and LT18 Landscape Tiller	N/A			X	The tiller drum rotates clockwise when you view the left side of the landscape tiller.
			X		The tiller drum rotates counterclockwise when you view the left side of the landscape tiller.

(continued)

(Table 14, contd)

OPERATION OF CATERPILLAR COMPLEX HYDROMECHANICAL WORK TOOLS					
Work Tool	Position of Fourth Function Control		Position of Auxiliary Hydraulic Control		Results
	C2	C1	A1	A2	
PC3 and PC4 Cold Planers	N/A		X		If the sideshift control is in the PLANER position, the drum rotates clockwise when you view the left side of the cold planer. If the sideshift control is in the SIDESHIFT position, the cutting head will shift toward the left side of the cold planer.
				X	If the sideshift control is in the PLANER position, the cold planer does not operate. If the sideshift control is in the SIDESHIFT position, the cutting head will shift toward the right side of the cold planer.
PC203 and PC204 Cold Planers	N/A		X		If the sideshift control is in the PLANER position, the drum rotates clockwise when you view the left side of the cold planer. If the sideshift control is in the SIDESHIFT position, the cutting head will shift toward the left side of the cold planer.
				X	If the sideshift control is in the PLANER position, the cold planer does not operate. If the sideshift control is in the SIDESHIFT position, the cutting head will shift toward the right side of the cold planer.
H63 H63S Hammers	N/A		X		The Hammer does not operate.
				X	The Hammer operates.
SG16 Stump Grinder				X	The cutting wheel rotates counterclockwise when you view the motor side.
	X			X	The cutting head angles to the left while the cutting wheel rotates. The Auxiliary Electrical Control is in the ON position.
		X		X	The cutting head angles to the right while the cutting wheel rotates. The Auxiliary Electrical Control is in the ON position.
		X		X	The cutting head retracts while the cutting wheel rotates. The Auxiliary Electrical Control is in the OFF position.
	X			X	The cutting head extends while the cutting wheel rotates. The Auxiliary Electrical Control is in the OFF position.
			X		The work tool does not operate.
SR17 Snowblower, SR18 Snowblower and SR21 Snowblower	N/A			X	The auger rotates counterclockwise when you view the snowblower from the left side of the machine.
			X		The auger rotates clockwise when you view the snowblower from the left side of the machine.

(1) The control is not applicable.

Parking

i01871966

Stopping the Engine

i01992184

SMCS Code: 1000; 7000

NOTICE

Stopping the engine immediately after it has been working under load, can result in overheating and accelerated wear of the engine components.

Refer to the following procedure, to allow the engine to cool, and to prevent excessive temperatures in the turbocharger housing (if equipped), which could cause oil coking problems.

1. Operate the engine for five minutes at low idle with no load.

Note: This allows hot areas in the engine to cool gradually. This will extend the engine life.

2. Move the joysticks into the HOLD position.
3. Turn the engine start switch key to the OFF position.
4. Relieve the pressure in the auxiliary hydraulic system. Refer to Operation and Maintenance Manual, "Work Tool Coupler Operation" for details.
5. Ensure that the engine start switch key is in the OFF position after the pressure in the auxiliary hydraulic system has been relieved.
6. Cover the exhaust opening after the machine has cooled down.

Stopping the Engine if an Electrical Malfunction Occurs

SMCS Code: 1000; 7000

1. Lower the work tool to the ground.
2. Raise the armrest. Unfasten the seat belt. Exit the machine.
3. Open the engine access door. Refer to Operation and Maintenance Manual, "Access Doors and Covers".

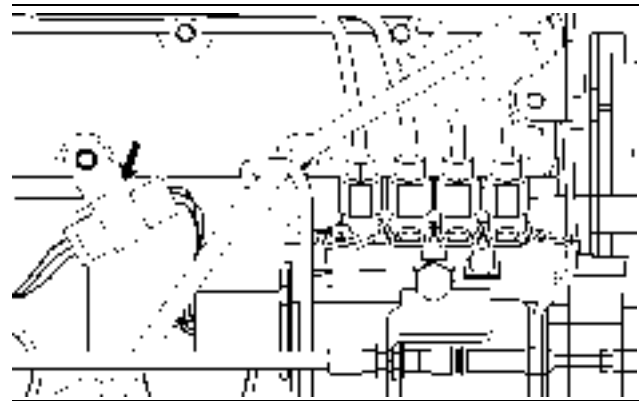

Illustration 66

g00953400

4. Unplug the connector for the fuel shutoff solenoid that is located on the left side of the engine.

Note: Do not operate the machine until the malfunction has been corrected.

i01872022

Equipment Lowering with Engine Stopped

SMCS Code: 6700; 7000

WARNING

Personal injury or death can result from a work tool falling.

Keep personnel away from the front of the machine when lowering the work tool.

Before lowering any equipment with the engine stopped, clear the area around the equipment of all personnel. The procedure will vary with the type of equipment that is lowered. Keep in mind that most systems use a high pressure fluid or air in order to raise or lower the equipment. The procedure will cause high pressure air, hydraulic fluid, or some other media to be released in order to lower the equipment. Wear appropriate personal protective equipment and follow the established procedure in the Operation and Maintenance Manual, "Equipment Lowering with Engine Stopped" in the Operation Section of the manual.

Lowering the Equipment with the Accumulator Charged

If electrical power is available and the accumulator is charged, the loader arms can be lowered from the operator station with the work tool control.

1. Fasten the seat belt. Lower the armrest.
2. Turn the engine start switch key to the ON position.
3. Push the parking brake switch.
4. Slowly move the work tool control to the LOWER position in order to slowly lower the loader arms.

If the loader arms do not lower, the accumulator is not charged. It is possible to recharge the accumulator by cranking the engine for a period of fifteen seconds. Repeat step 3 and 4.

If there is no electrical power the loader arms must be lowered by using the procedure that is explained next.

Lowering the Equipment with the Accumulator Discharged



Personal injury can result from oil under high pressure.

DO NOT allow high pressure oil to contact skin.

Wear appropriate protective equipment while working with high pressure oil systems.

The loader arms must be lowered manually if the loader arms cannot be lowered by using the previous procedure.

Do not go under the raised lift arm without the brace for the loader lift arm in the LOCKED position. Use the alternate exit if the brace for the loader lift arm cannot be installed on raised lift arms.

1. Open the engine access door. Refer to Operation and Maintenance Manual, "Access Doors and Covers".

Note: Make sure that there are no people near the front or sides of the machine.

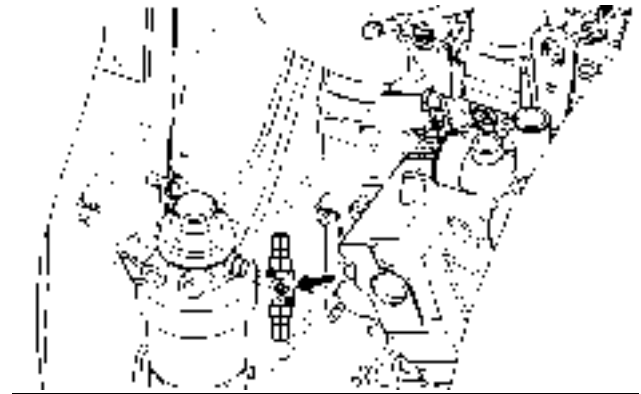

Illustration 67

g00953450

2. The bypass valve is located on the left side of the engine compartment. Slowly turn the square stem on the bypass valve in a clockwise direction. The square stem should be rotated 90 degrees. Allow the loader arms to lower until the work tool is on the ground.
3. Slowly turn the square stem on the bypass valve in a counterclockwise direction until the stem stops. The square stem should be rotated 90 degrees.
4. Close the engine access door.
5. Make the necessary repairs before you operate the machine.

i01947381

Machine Storage Procedure

SMCS Code: 7000

NOTICE

If long term storage for a period of time exceeding one year is necessary, contact your local Caterpillar dealer for the preferred procedure to use in your specific case.

This machine may be stored for one year or less in a temperature range of -32°C (-25.6°F) to 43°C (109.4°F).

To store machines in ambient temperatures between $-20\text{ }^{\circ}\text{C}$ ($-4.0\text{ }^{\circ}\text{F}$) to $43\text{ }^{\circ}\text{C}$ ($109.4\text{ }^{\circ}\text{F}$), refer to Special Instructions, SEHS9031, "Storage Procedure for Caterpillar Products".

To store machines in ambient temperatures between $-32\text{ }^{\circ}\text{C}$ ($-26\text{ }^{\circ}\text{F}$) and $-21\text{ }^{\circ}\text{C}$ ($-6\text{ }^{\circ}\text{F}$), refer to the following publications and topics:

- Special Instructions, SEHS9031, "Storage Procedure For Caterpillar Products"
- Operation and Maintenance Manual, SEBU5898, "Cold Weather Recommendations for Caterpillar Machines"

Note: Do not use the steps that are listed in Special Instructions, SEHS9031 in order to maintain the fuel system.

Use the following steps to maintain the fuel system.

1. Drain the fuel tank. Follow the procedure that is described in Operation and Maintenance Manual, "Fuel Tank Water and Sediment - Drain".
2. Drain the water separator and replace the element. Follow the procedure that is described in Operation and Maintenance Manual, "Fuel System Water Separator Element - Replace".
3. Replace the fuel filter. Follow the procedure that is described in Operation and Maintenance Manual, "Fuel System Filter - Replace".
4. Fill the fuel tank so that the fuel tank is at least 20% full with Calibration Fluid.
5. Prime the system by operating the fuel system priming pump. Follow the procedure that is described in Operation and Maintenance Manual, "Fuel System Priming Pump - Operate".
6. Start the engine and run at low idle for approximately 15 minutes in order to allow the calibration fluid to flush the diesel fuel from the system.
7. Turn off the engine.
8. Add .15 mL (0.02 oz) of commercial biocide for every 1 L (0.3 US gal) of calibration fluid to the fuel tank. Seal all openings to the fuel tank in order to prevent evaporation of the preservative.

Transportation Information

i01632001

Shipping the Machine

SMCS Code: 7000

Investigate the travel route for overpass clearances. Make sure that there will be adequate clearance.

Before you load the machine and before you unload the machine remove ice, snow, or other slippery material from the loading dock and from the trailing surface. Removal of ice, snow, or other slippery material will help prevent the slipping of the machine as you load the machine. Removing ice, snow, or other slippery material will help prevent the machine from moving in transit.

NOTICE

Obey all state and local laws governing the weight, width and length of a load.

Make sure the cooling system has proper antifreeze if moving machine to a colder climate.

Observe all regulations governing wide loads.

Do not use a fork lift to lift the machine. Using a fork lift to move your machine can result in property damage.

Choose the flattest ground when you load the machine or when you unload the machine.

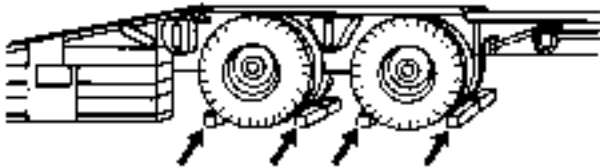

Illustration 68

g00040011

1. Before you load the machine chock the trailer wheels or the rail car wheels. Before you unload the machine chock the trailer wheels or the rail car wheels.

2. When you use loading ramps, make sure that the loading ramps have adequate length, adequate width, and adequate strength. In addition, make sure that the surface of the loading ramps are clean. This will help prevent the machine from sliding in all types of weather conditions. This will allow the machine to move on the ramps smoothly.
3. Maintain the slope of the loading ramps within 15 degrees of the ground.
4. Minimize any step between the base of the loading ramps and the ground.
5. Clean the tracks on the machine in order to prevent any slippage.

Loading the Machine

1. Position the machine so that the heaviest end of the machine is going up the ramps first.
2. Use caution when you travel over the areas around the loading ramp joints. Maintain the balance point of the machine. Keep the work tool low.
3. After you load the machine onto the trailer be sure that the machine is properly positioned on the trailer bed.
4. Lower the work tool to the floor of the transport vehicle.
5. Turn the engine start switch key to the OFF position in order to stop the engine.
6. Turn the engine start switch key to the ON position. Push the parking brake switch.
7. Move all hydraulic control levers while you are pressing several times on each side of the auxiliary hydraulic control (if equipped) in order to relieve hydraulic pressure.
8. Move all hydraulic control levers to the HOLD position.
9. Turn the engine start switch key to the OFF position. Remove the engine start switch key.
10. Move the armrest to the RAISED position. Unfasten the seat belt.
11. Attach any vandalism protection.
12. Refer to the Operation and Maintenance Manual, "Lifting and Tying Down the Machine" for information on tying down the machine.

13. Cover the exhaust opening when the machine has cooled down.

Unloading the Machine

1. Position the machine so that the machine can drive straight down the loading ramps. Position the machine so that the heaviest end of the machine goes down the ramps last.
2. Use caution when you travel over the areas around the loading ramp joints in order to maintain the balance point of the machine. Keep the work tool low.

i01956162

Roading the Machine

SMCS Code: 7000

Perform a thorough Daily Inspection. Refer to Operation and Maintenance Manual, "Daily Inspection".

Check with the proper officials in order to obtain the required licenses and other similar items.

Ensure that your machine is equipped to comply with roading regulations.

Travel at a moderate speed. Observe all speed limitations when you road the machine.

i02112041

Lifting and Tying Down the Machine

SMCS Code: 7000

NOTICE

Improper lifting or tiedowns can allow load to shift and can cause injury and damage.

Lifting the Machine

The single point lifting eye and the four-point lifting group are available for the machine.

For lifting the machine, use properly rated cables and properly rated slings. Position the crane for a level machine lift. Do not drag the machine with a crane.

The machine can be lifted with a bucket that is not hydraulic. The machine can be lifted with a pallet fork that is not hydraulic. All other work tools must be removed from the machine before the machine is lifted.

Do not allow any personnel in the area around the machine.

Lifting from a Single Point

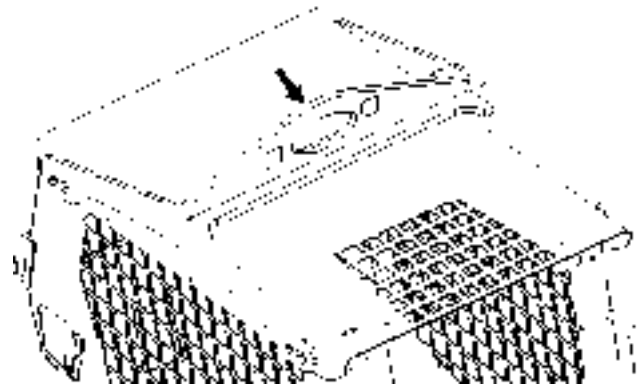

Illustration 69

g00930025

Single point lifting eye

Lifting from Four Points

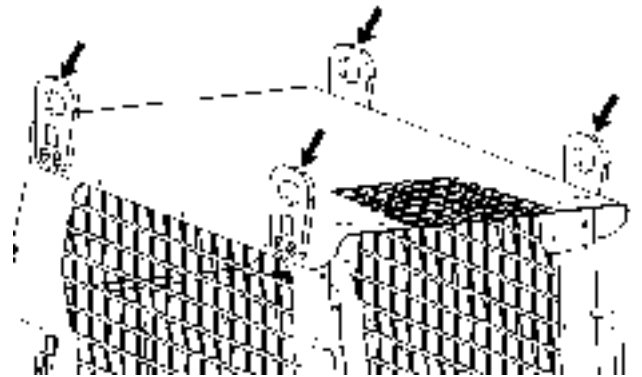

Illustration 70

g00930032

Four-point lifting group

When the four-point lifting group is used, the chain for each leg should be a minimum of 1 m (3.3 ft) in length.

Please refer to the Caterpillar Parts Manual for the current part number for the lifting device for your machine. The parts manuals are listed in the Operation and Maintenance Manual, "Reference Information Section".

Tying Down the Machine

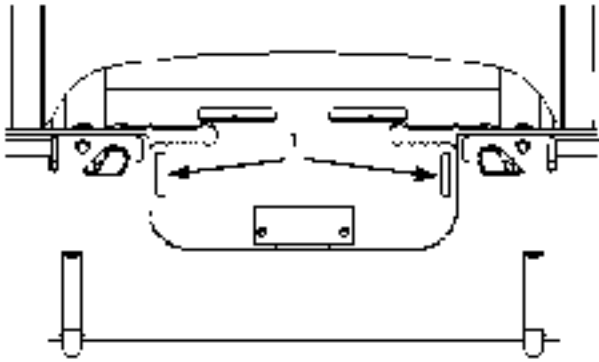

Illustration 71

g01019061

The two front eyes (1) are provided for tie-downs.



Illustration 72

g01019063

The two rear eyes (2) are provided for tie-downs.

Install tie-downs at all four locations. Place chocks in front of the machine and behind the machine.

Consult your Caterpillar dealer for shipping instructions for your machine.

Towing Information

i01821491

Towing the Machine

SMCS Code: 7000

If the machine is disabled, the machine should be lifted onto a trailer in order to be transported. Refer to Operation and Maintenance Manual, "Lifting and Tying Down the Machine" for the lifting procedure.

Retrieval of Machine

If the machine cannot be lifted, use the following guidelines in order to retrieve the machine.

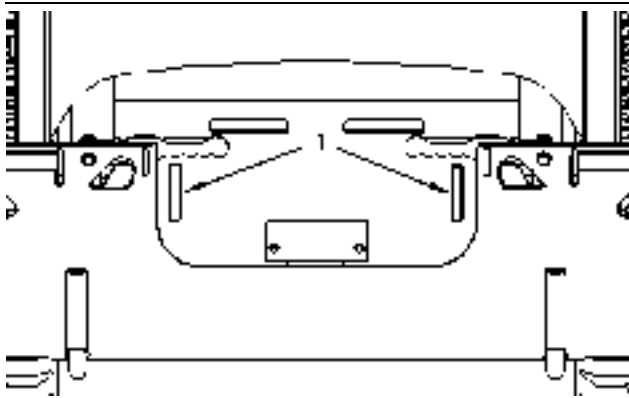

Illustration 73

g00929955

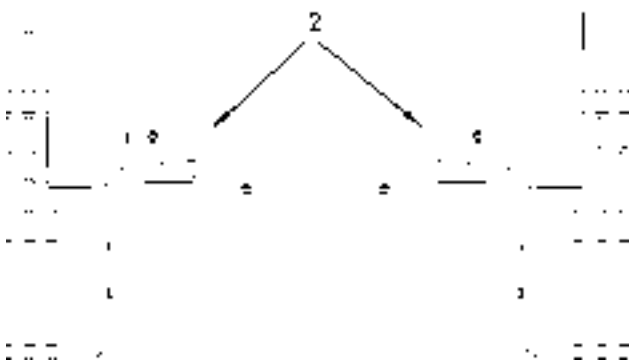

Illustration 74

g00930014

- The strength of the line should be at least 1.5 times the gross weight of the machine.
- Provide shielding in order to protect the operator if the line breaks.

- Attach the line to the towing eyes. Two towing eyes (1) are located on the front of the machine and two towing eyes (2) are located on the rear of the machine. Do not attach the line to any other point on the machine. Do not attach the line to only one towing eye when you are retrieving the machine.
- If a single line is used to pull the machine, then the line must be a minimum of 3 m (10 ft). If two lines are used to pull the machine, then each line must be a minimum of 1.5 m (5.0 ft).
- Do not exceed a maximum pull angle of 20 degrees in any direction.

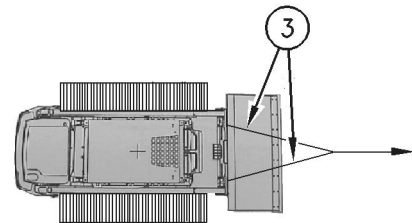

Illustration 75

g0077765

Each of the lines (3) must be a minimum of 1.5 m (5.0 ft).

NOTICE

Do not drag the machine for long distances. Damage to the tracks and to the machine may occur.

Engine Starting (Alternate Methods)

i02065056

Engine Starting with Jump Start Cables

SMCS Code: 1000; 1401; 7000

 **WARNING**

Batteries give off flammable fumes that can explode resulting in personal injury.

Prevent sparks near the batteries. They could cause vapors to explode. Do not allow the jump start cable ends to contact each other or the machine.

Do not smoke when checking battery electrolyte levels.

Electrolyte is an acid and can cause personal injury if it contacts skin or eyes.

Always wear eye protection when starting a machine with jump start cables.

Improper jump start procedures can cause an explosion resulting in personal injury.

Always connect the positive (+) to positive (+) and the negative (-) to negative (-).

Jump start only with an energy source with the same voltage as the stalled machine.

Turn off all lights and accessories on the stalled machine. Otherwise, they will operate when the energy source is connected.

NOTICE

To prevent damage to engine bearings and to electrical circuits when you jump start a machine, do not allow the stalled machine to touch the machine that is used as the electrical source.

Severely discharged maintenance free batteries do not fully recharge from the alternator after jump starting. The batteries must be charged to proper voltage with a battery charger. Many batteries thought to be unusable are still rechargeable.

Use only equal voltage for starting. Check the battery and starter voltage rating of your machine. Use only the same voltage for jump starting. Use of a welder or higher voltage damages the electrical system. This machine has a 12 volt starting system. Use only the same voltage for jump starting.

Refer to Special Instruction, SEHS7633, "Battery Test Procedure" available from your Caterpillar dealer, for complete testing and charging information.

-
1. Engage the parking brake. Lower the work tools to the ground.
Reference: Refer to Operation and Maintenance Manual, "Equipment Lowering with Engine Stopped".
 2. Move all control levers to the HOLD or NEUTRAL position.
 3. Turn the engine start switch key to the OFF position and turn all accessory switches to the OFF position.
 4. Move the machine that is being used as an electrical source near the stalled machine so that the jump start cables reach the stalled machine.
Do not allow the machines to contact each other.
 5. Stop the engine of the machine that is being used as an electrical source. If you are using an auxiliary power source, turn off the charging system.
 6. Ensure that battery caps on both machines are tight and correctly placed. Ensure that batteries in the stalled machine are not frozen.
 7. Connect the positive jump start cable to the positive cable terminal of the discharged battery.

Do not allow the positive cable clamps to contact any metal except for the battery terminals.

-
8. Connect the other positive end of the jump start cable to the positive cable terminal of the electrical source.
 9. Connect one negative end of the jump start cable to the negative cable terminal of the electrical source.
 10. Connect the other negative end of the jump start cable to the engine block or to the frame of the stalled machine. **Do not connect the jump start cable to the battery post. Do not allow the jump start cables to contact the battery cables, the fuel lines, the hydraulic lines, or any moving parts.**
 11. Start the engine of the machine that is being used as an electrical source or energize the charging system on the auxiliary power source.
 12. Wait at least two minutes before you attempt to start the stalled machine. This will allow the battery in the stalled machine to partially charge.
 13. Attempt to start the stalled engine.

Reference: For the correct starting procedure, refer to Operation and Maintenance Manual, "Engine Starting".
 14. After the stalled engine starts, disconnect the negative jump start cable from the stalled machine.
 15. Disconnect the negative jump start cable from the negative terminal of the electrical source.
 16. Disconnect the positive jump start cable from the positive terminal of the electrical source.
 17. Disconnect the positive jump start cable from the positive terminal of the stalled machine.
 18. Conclude the failure analysis on the starting system of the stalled machine and/or on the charging system of the stalled machine. Check the machine while the engine is running and the charging system is in operation.

Maintenance Section

Maintenance Access

i01871110

Access Doors and Covers

SMCS Code: 7273-572; 7273-573

Engine Access Door

The engine access door is located on the back of the machine.

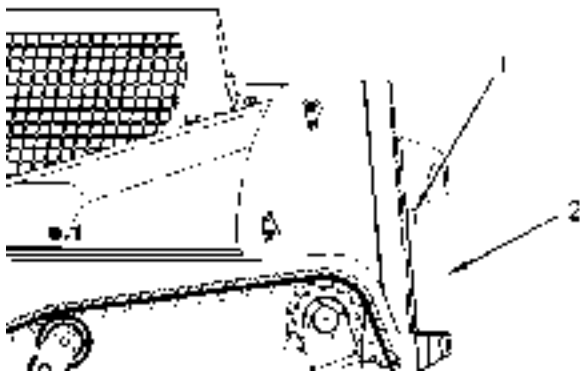

Illustration 76

g00952785

1. Pull the release lever (1) in order to open the engine access door (2).

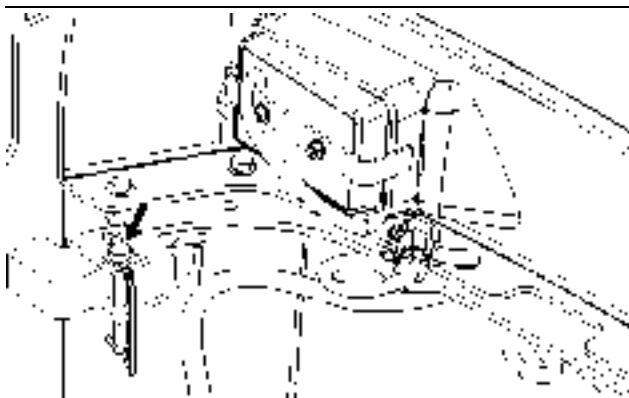

Illustration 77

g00953149

2. Put the retaining pin in the locked position so the engine access door does not close inadvertently.

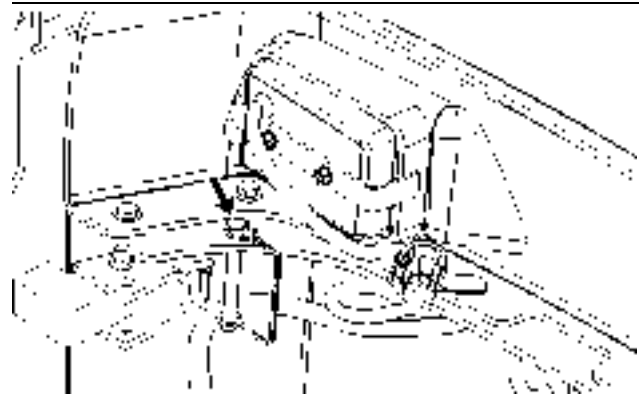

Illustration 78

g00953140

3. In order to close the engine access door, put the retaining pin in the stored position.

4. Close the engine access door.

Note: A pinch point exists between the top of the engine access door and the radiator guard. Keep hands away from this area when you close the engine access door.

i01821601

Cab Tilting

SMCS Code: 7301-506; 7301-509



Do not go beneath cab unless cab is empty and support lever is engaged.

Failure to follow the instructions or heed the warnings could result in injury or death.

Tilting the Cab Upward

1. Park the machine on level ground.

Note: Empty the water tank (if equipped) before you tilt the cab.

2. Lower the loader arms fully. If you tilt the cab upward with the loader lift arms in the RAISED position, you must engage the brace for the loader lift arms. See Operation and Maintenance Manual, "Loader Lift Arm Brace Operation" for the process for engaging the brace for the loader lift arms.

3. Turn the engine start switch key to the OFF position.

4. Place supports under the rear of the machine in order to support the machine while the cab is tilted.

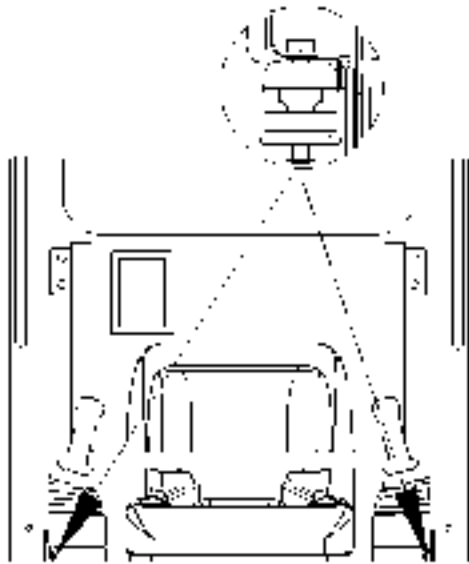

Illustration 79

g00930086

5. Remove the two front bolts for the ROPS.
6. Tilt the cab upward. Stand on the ground when you tilt the cab.

Note: More than one person may be needed to tilt the cab.



Illustration 80

g00954946



Illustration 81

g00952728

The cab support lever is in the ENGAGED position.

7. Make sure that the cab support lever is in the ENGAGED position.

Tilting the Cab Downward

Note: More than one person may be needed to tilt the cab.

1. Ensure that all persons are not under the cab. Remove all of the tools and unsecured items that are underneath the cab.

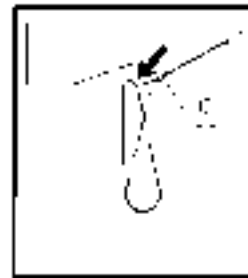

Illustration 82

g00952719

The cab support lever is shown in the DISENGAGED position.

2. Tilt the cab upward. Move the cab support lever to the DISENGAGED position.
3. Tilt the cab downward and install the bolts for the ROPS. Torque the bolts to 125 ± 20 N·m (92 ± 15 lb ft).
4. Remove the supports from the rear of the machine.

Application Guide for Gas Struts

The struts that support the cab are matched to the weight of the cab. Refer to this chart for the correct strut if the configuration of the cab is changed.

Table 15

Spring Factoring Table		
Part Number	Name	Factor
142-9310	Seat and Mounting (Static)	0
142-9305	Seat and Mounting (Suspension)	1
142-9362	Cab Window (Top and Rear)	0
195-6723	Cab Window (Top and Rear)	0
142-9363	Cab Window (Side Without Heater)	2
187-3213	Cab Window (Side With Heater)	2
142-9302	Cab Door (Glass Window)	4
195-6724	Cab Door (Glass Window)	4
159-5800	Cab Door (Polycarbonate Window)	4
195-6726	Cab Door (Polycarbonate Window)	4
152-1160	ROPS/FOPS Guard (FOPS 2)	4
142-9110	Machine Lifting (Four Point)	1
152-1155	Machine Lifting (Single Point)	3
190-8090	Machine Lifting (Single Point)	3
166-2550	Water Tank Gp	3
193-0451	Water Tank Gp	3
Sum of Factors		
		Sum of Factors
OPTION 1	The right side gas strut 153-2682	0-2
OPTION 2	The right side gas strut 153-2683 The left side gas strut 153-2683	3-6

(continued)

(Table 15, contd)

OPTION 3	The right side gas strut 153-2682 The left side gas strut 153-2683	7-9
OPTION 4	The right side gas strut 153-2682 The left side gas strut 153-2682	10+

101961564

Loader Lift Arm Brace Operation

SMCS Code: 6119-011-AB; 6119-012-AB



Loader lift arm brace must be in place when working under raised lift arms.

Failure to follow the instructions or heed the warnings could result in injury or death.

Engage the Lift Arm Brace (Radial Lift)

1. Empty the work tool. Remove the work tool. Park the machine on level ground. Lower lift arms to the ground. Stop the engine and exit the machine.

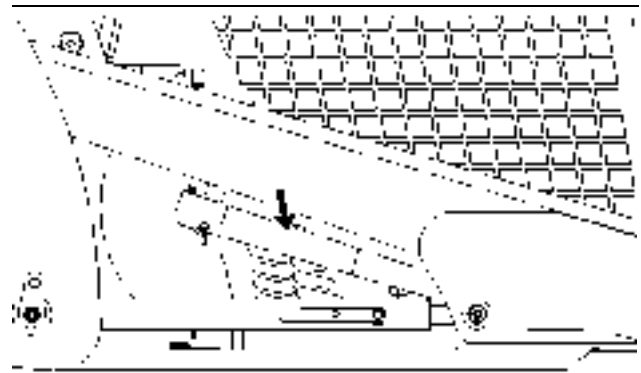

Illustration 83

g00930196

2. Remove the pin that holds the lift arm brace in the stored position.
3. Lower the lift arm brace to rest on the cylinder housing.
4. Mount the machine. Secure the seat belt and lower the armrest. Start the engine.

5. Raise the lift arms until the brace falls onto the cylinder rod. Slowly lower the lift arms until the brace stops movement.

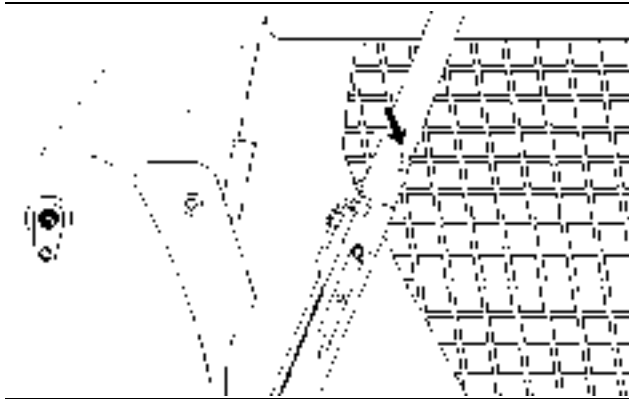

Illustration 84

g00952492

6. Stop the engine. Exit the machine. Secure the retaining pin through the brace below the cylinder rod.

Disengage the Lift Arm Brace (Radial Lift)

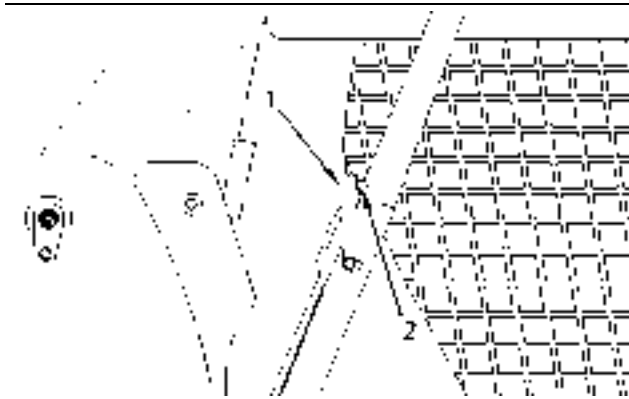

Illustration 85

g00952586

1. Remove the retaining pin from the brace and install the pin (2) in the holding block.
2. Detach and swing the pivot lever (1) clockwise onto the retaining pin.
3. Mount the machine. Secure the seat belt and lower the armrest. Start the engine.

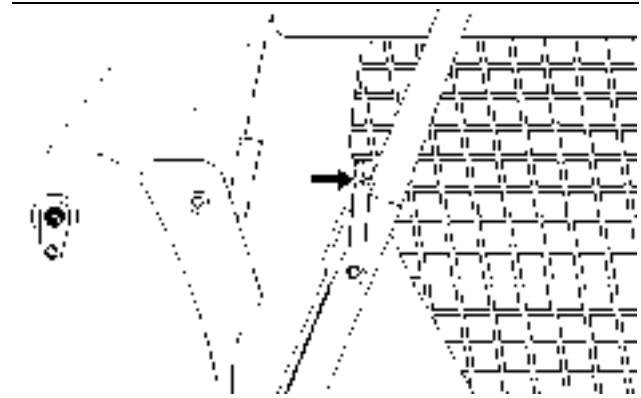

Illustration 86

g00952609

4. Slowly raise the loader lift arms until the lever engages the retaining pin.
5. Slowly lower the lift arms to the ground. Stop the engine. Exit the machine.
6. Raise and secure the brace to the lift arm with the retaining pin.
7. Install the pivot lever into the STORED position.

Engage the Lift Arm Brace (Extended Lift)

1. Empty the work tool. Remove the work tool. Park the machine on level ground. Raise the lift arms to maximum height.
2. Remain in the seat with the seat belt fastened until the brace is installed.

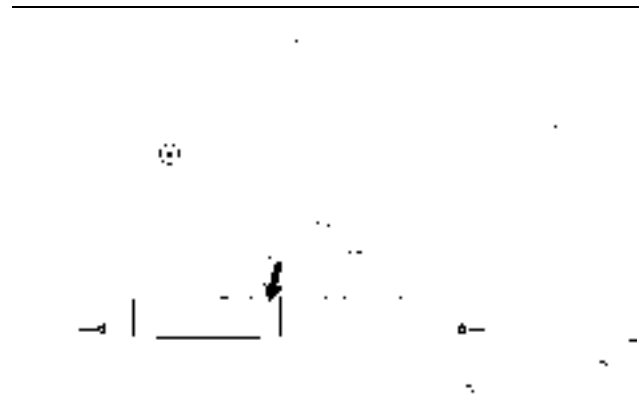

Illustration 87

g00930202

3. A second person must remove the brace from the storage position by removing the retaining pins.

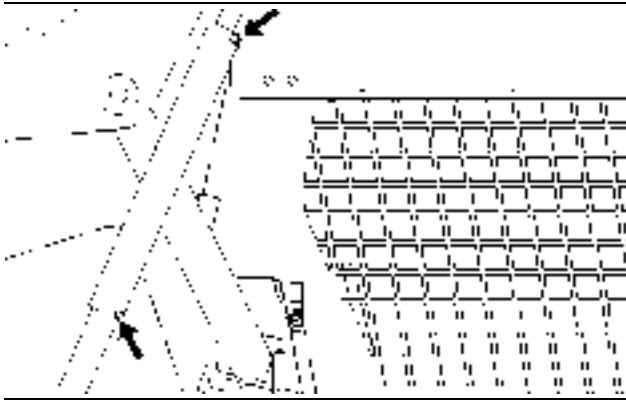

Illustration 88

g00952659

4. The second person should then install the brace over the rod of one of the lift cylinders.
5. Lower the loader arms slowly until the brace is held tightly between the rod and the cylinder.
6. Secure the two retaining pins through the brace below the rod.

Disengage the Lift Arm Brace (Extended Lift)

1. Mount the machine. Fasten the seat belt. Lower the armrest and remain in the seat until the brace is removed.
2. Slowly raise the lift arms until the brace is free.
3. A second person must remove the retaining pins and the brace from the rod.
4. Slowly lower the lift arms to the ground.
5. The second person should return the brace to the storage location. Attach the brace with the retaining pins.

i01848989

Radiator Tilting

SMCS Code: 1353-506; 1353-509

1. Open the engine access door. Refer to Operation and Maintenance Manual, "Access Doors and Covers".

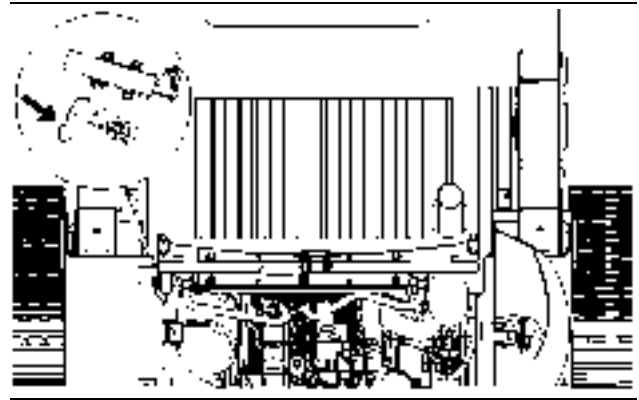

Illustration 89

g00941929

2. Pull the release lever for the radiator latch. Tilt the radiator upward.

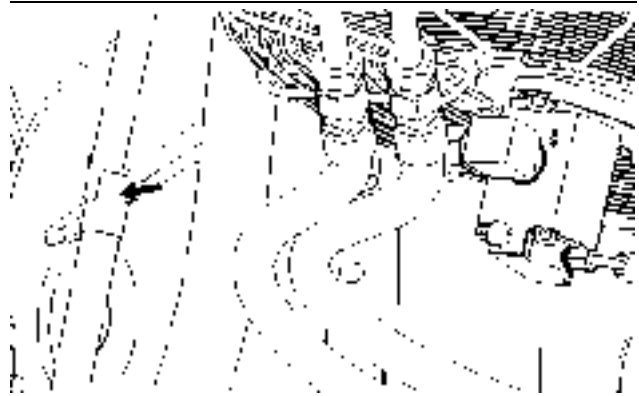

Illustration 90

g00960146

3. Make sure that the strut lock is in the LOCKED position.
4. In order to tilt the radiator downward, push the strut lock to the left.
5. Tilt the radiator downward. Make sure that the radiator is in the LOCKED position.
6. Close the engine access door.

Tilting the Radiator Guard

1. Open the engine access door. Refer to Operation and Maintenance Manual, "Access Doors and Covers".

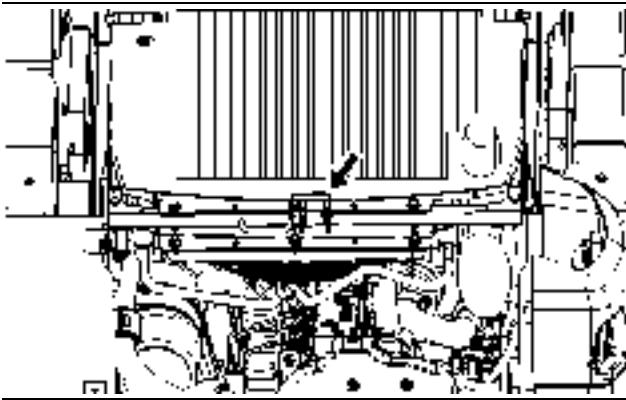

Illustration 91

g00955515

2. Remove the retaining pin from the radiator guard.
Tilt the radiator guard upward.
3. In order to tilt the radiator guard downward,
pull down on the radiator guard and install the
retaining pin.

Lubricant Viscosities and Refill Capacities

i02410257

Lubricant Viscosities

SMCS Code: 7581

The proper oil viscosity grade is determined by the minimum outside temperature when the machine is started. The proper oil viscosity grade is also determined by the maximum outside temperature while the machine is operated. Use the column that has the title of "Min" on the table to determine the oil viscosity grade that is required for starting a cold machine. Use the column that has the title of "Max" on the table to determine the oil viscosity grade for operating the machine at the highest temperature that is anticipated. Use the oil with the highest viscosity that is allowed for the ambient temperature when you start the machine.

Table 16

Lubricant Viscosities for Ambient Temperatures						
Compartment or System	Oil Type and Classification	Oil Viscosities	°C		°F	
			Min	Max	Min	Max
Engine Crankcase for all Machines ⁽¹⁾⁽²⁾	Cat DEO Multigrade Cat DEO SYN Cat Arctic DEO SYN ⁽³⁾ Cat ECF-1 ⁽⁴⁾ API CG-4 Multigrade ⁽⁵⁾	SAE 0W-20	-40	10	-40	50
		SAE 0W-30	-40	30	-40	86
		SAE 0W-40	-40	40	-40	104
		SAE 5W-30	-30	30	-22	86
		SAE 5W-40	-30	50	-22	122
		SAE 10W-30 ⁽⁶⁾	-18	40	0	104
		SAE 10W-40	-18	50	0	122
		SAE 15W-40	-9.5	50	15	122

(continued)

(Table 16, contd)

Lubricant Viscosities for Ambient Temperatures						
Compartment or System	Oil Type and Classification	Oil Viscosities	°C		°F	
			Min	Max	Min	Max
Hydraulic Systems, Hydrostatic Transmission	Cat HYDO Cat DEO Cat MTO Cat TDTO Cat TDTO-TMS Cat DEO SYN Cat Arctic DEO SYN Cat Arctic TDTO Cat ECF-1 Cat BIO HYDO (HEES) API CG-4 API CF commercial TO-4 commercial BF-1	SAE 0W-20	-40	40	-40	104
		SAE 0W-30	-40	40	-40	104
		SAE 0W-40	-40	40	-40	104
		SAE 5W-30	-30	40	-22	104
		SAE 5W-40	-30	40	-22	104
		SAE 10W	-20	40	-4	104
		SAE 30	10	50	50	122
		SAE 10W-30	-20	40	-4	104
		SAE 15W-40	-15	50	5	122
		Cat MTO	-25	40	-13	104
		Cat BIO HYDO (HEES)	-40	43	-40	110
		Cat TDTO-TMS	-20	50	-4	122
Idler Wheel Tubes and Bogie Wheel Tubes 267, 277 and 287	Caterpillar GO Caterpillar Synthetic GO ⁽⁷⁾ API GL-5	SAE 80W-90	-20	40	-4	104
External Lubrication Points	Advanced 3Moly	NLGI Grade 2	-20	40	-4	104

- (1) Supplemental heat is recommended for cold-soaked starts below the minimum ambient temperature. Supplemental heat may be required for cold-soaked starts that are above the minimum temperature that is stated, depending on the parasitic load and other factors. Cold-soaked starts occur when the engine has not been operated for a period of time. This allows the oil to become more viscous due to cooler ambient temperatures.
- (2) API CF oils are not recommended for Caterpillar 3500 Series and smaller Direct Injection (DI) diesel engines. API CF-4 oils are not recommended for Caterpillar diesel engines.
- (3) Cat Arctic DEO SYN is an SAE 0W30 viscosity grade oil.
- (4) API CI-4, API CI-4 PLUS, and API CH-4 oils are acceptable if the requirements of Caterpillar's ECF-1 (Engine Crankcase Fluid specification - 1) are met. API CI-4, API CI-4 PLUS, and API CH-4 oils that have not met the requirements of Caterpillar's ECF-1 specification may cause reduced engine life.
- (5) API CG-4 oils are acceptable for use in all Caterpillar machine diesel engines. When API CG-4 oils are used, the oil change interval should not exceed 250 hours. API CG-4 oils that also meet API CI-4, API CI-4 PLUS, or API CH-4 must also meet the requirements of the Caterpillar ECF-1 specification.
- (6) SAE 10W-30 is the preferred viscosity grade for the 3116, 3126, C7, C-9 and the C9 diesel engines when the ambient temperature is between -18° C (0° F) and 40° C (104° F).
- (7) Cat Synthetic GO is an SAE 75W-140 viscosity grade oil.

i02098494

i01822901

Capacities (Refill)

SMCS Code: 7560

Table 17

Approximate Refill Capacities			
Compartment or System	Liters	US Gallons	Imperial Gallons
3034 Engine Crankcase New Engine The "ADD" mark on the Dipstick	7	1.9	1.5
3034 Engine Crankcase New Engine The "FULL" mark on the Dipstick	9	2.4	2
3034 Engine Crankcase Used Engine The "ADD" mark on the Dipstick	6	1.6	1.3
3034 Engine Crankcase Used Engine The "FULL" mark on the Dipstick	8	2.1	1.8
Hydraulic Tank	35	9.3	7.7
Cooling System	10	2.6	2.2
Fuel Tank 247	62	16.4	13.6
Fuel Tank 257	90	23.8	19.8
Fuel Tank 267 and 277	80	21.1	17.6
Fuel Tank 287	110	29.0	24.1
Idler Wheel Tubes and Bogie Wheel Tubes 267, 277 and 287	0.26	0.07	0.06

Note: A "new" engine refers to an engine that has never been run. A "new" engine refers to an engine that has never been filled with oil.

S-O-S Information

SMCS Code: 1000; 7000; 7542-008

S-O-S Services is a highly recommended process for Caterpillar customers to use in order to minimize owning and operating cost. Customers provide oil samples, coolant samples, and other machine information. The dealer uses the data in order to provide the customer with recommendations for management of the equipment. In addition, S-O-S Services can help determine the cause of an existing product problem.

Refer to Special Publication, SEBU6250, "Caterpillar Machine Fluid Recommendations" for detailed information concerning S-O-S Services.

Refer to the Operation and Maintenance Manual, "Maintenance Interval Schedule" for a specific sampling location and a service hour maintenance interval.

Consult your Caterpillar dealer for complete information and assistance in establishing an S-O-S program for your equipment.

Maintenance Support

i02000840

Welding on Machines and Engines with Electronic Controls

SMCS Code: 1000; 7000

Proper welding procedures are necessary in order to avoid damage to the electronic controls and to the bearings. When possible, remove the component that must be welded from the machine or the engine and then weld the component. If you must weld near an electronic control on the machine or the engine, temporarily remove the electronic control in order to prevent heat related damage. The following steps should be followed in order to weld on a machine or an engine with electronic controls.

1. Turn off the engine. Place the engine start switch in the OFF position.
2. If equipped, turn the battery disconnect switch to the OFF position. If there is no battery disconnect switch, remove the negative battery cable at the battery.

NOTICE

Do NOT use electrical components (ECM or ECM sensors) or electronic component grounding points for grounding the welder.

3. Clamp the ground cable from the welder to the component that will be welded. Place the clamp as close as possible to the weld. Make sure that the electrical path from the ground cable to the component does not go through any bearing. Use this procedure in order to reduce the possibility of damage to the following components:
 - Bearings of the drive train
 - Hydraulic components
 - Electrical components
 - Other components of the machine
4. Protect any wiring harnesses from the debris which is created from welding. Protect any wiring harnesses from the splatter which is created from welding.
5. Use standard welding procedures in order to weld the materials together.

i02418872

Maintenance Interval Schedule

SMCS Code: 7000

Ensure that all safety information, warnings and instructions are read and understood before any operation or any maintenance procedures are performed.

The user is responsible for the performance of maintenance, including all adjustments, the use of proper lubricants, fluids, filters, and the replacement of components due to normal wear and aging. Failure to adhere to proper maintenance intervals and procedures may result in diminished performance of the product and/or accelerated wear of components.

Use mileage, fuel consumption, service hours, or calendar time, WHICH EVER OCCURS FIRST, in order to determine the maintenance intervals. Products that operate in severe operating conditions may require more frequent maintenance.

Note: Before each consecutive interval is performed, all maintenance from the previous interval must be performed.

When Required

Battery - Recycle	100
Battery or Battery Cable - Inspect/Replace	100
Bucket Cutting Edges - Inspect/Replace	106
Bucket Tips - Inspect/Replace	106
Cab Air Filter - Clean/Replace	107
Circuit Breakers and Fuses - Reset/Replace	107
Engine Air Filter Primary Element - Clean/Replace	112
Engine Air Filter Secondary Element - Replace ..	113
Engine Compartment - Clean	115
Engine Starting with Jump Start Cables	119
Fuel System Priming Pump - Operate	122
Fuel Tank Cap - Clean	123
Fuel Tank Water and Sediment - Drain	123
Lower Machine Frame - Clean	127
Oil Filter - Inspect	127
Track (Rubber) - Remove/Replace	138
Window Washer Reservoir - Fill	142
Window Wiper - Inspect/Replace	143
Windows - Clean	143

Every 10 Service Hours or Daily

Axle Bearings - Lubricate	100
Backup Alarm - Test	100
Bogie and Idler - Inspect/Replace	102
Cooling System Level - Check	111
Engine Air Filter Service Indicator - Inspect	114
Engine Oil Level - Check	117
Fuel System Primary Filter (Water Separator) - Drain	121

Hydraulic System Oil Level - Check	126
Lift Arm and Cylinder Linkage - Lubricate	126
Quick Coupler - Inspect	128
Radiator Core - Clean	128
Seat Belt - Inspect	130
Sprocket Retaining Nuts - Check	132
Tilt Cylinder Bearings and Bucket Linkage Bearings - Lubricate	132
Track (Rubber) - Inspect/Adjust	133
Work Tool - Lubricate	143
Work Tool Mounting Bracket - Inspect	145

Every 250 Service Hours

Engine Oil Sample - Obtain	117
----------------------------------	-----

Every 250 Service Hours or Monthly

Belts - Inspect/Adjust/Replace	101
--------------------------------------	-----

Every 500 Service Hours

Hydraulic Oil Sample - Obtain	124
-------------------------------------	-----

Every 500 Service Hours or 3 Months

Fuel System Primary Filter (Water Separator) Element - Replace	122
---	-----

Every 500 Service Hours or 6 Months

Fuel System Filter - Replace	120
Hydraulic System Oil Filter - Replace	125

Every 500 Service Hours or 1 Year

Engine Oil and Filter - Change	117
--------------------------------------	-----

Every 1000 Service Hours

Engine Valve Lash - Check	120
---------------------------------	-----

Every 1000 Service Hours or 6 Months

Engine Crankcase Breather - Clean	116
Rollover Protective Structure (ROPS) and Falling Object Protective Structure (FOPS) - Inspect ...	129

Every 1000 Service Hours or 1 Year

Bogie and Idler Oil Level - Check	105
Hydraulic System Oil - Change	124
Sprocket - Inspect	131
Sprocket Bearings - Lubricate	132

Every 2000 Service Hours

Refrigerant Dryer - Replace	129
-----------------------------------	-----

Every 2000 Service Hours or 1 Year

Fuel Injection Timing - Check	120
-------------------------------------	-----

Every 3000 Service Hours or 2 Years

Cooling System Coolant Extender (ELC) - Add ...	110
Cooling System Water Temperature Regulator - Replace	111

**Every 3 Years After Date of Installation or
Every 5 Years After Date of Manufacture**

Seat Belt - Replace	130
---------------------------	-----

Every 3000 Service Hours or 3 Years

Cooling System Coolant Extender (ELC) - Add ...	110
---	-----

Every 5000 Service Hours

Engine Crankcase Breather (Closed Circuit) - Replace	115
---	-----

Every 6000 Service Hours or 4 Years

Cooling System Coolant (ELC) - Change	108
---	-----

i01989568

Axle Bearings - Lubricate

SMCS Code: 3282-086-BD

S/N: CML1-Up

S/N: CMM1-Up

S/N: CNY1-Up

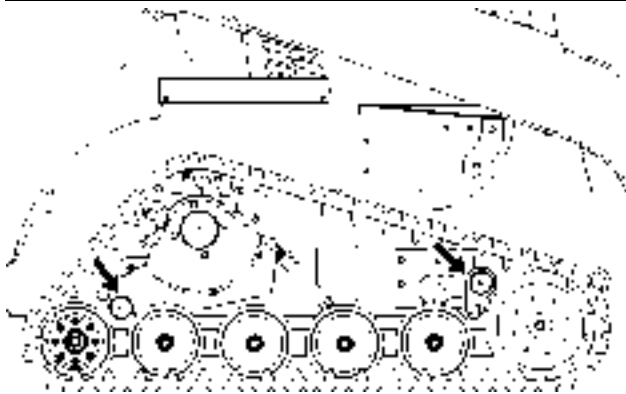

Illustration 92
247 and 257

g00895314

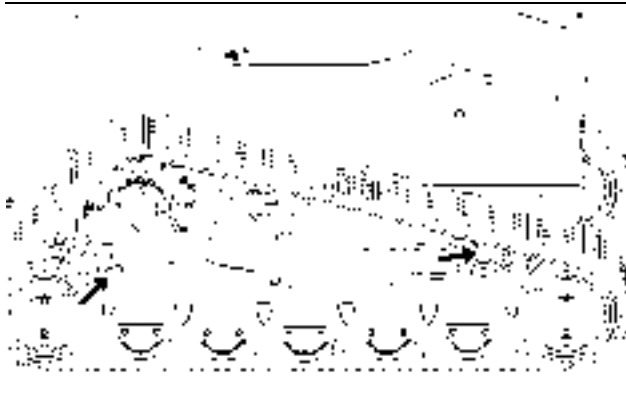

Illustration 93
287

g01030370

Apply lubricant to the grease fittings for the rear axle bearings and the front axle bearings.

Repeat the process for the opposite side of the machine.

i01017495

Backup Alarm - Test

SMCS Code: 7406-081

To prevent injury, make sure that no people are working on the machine or near the machine. To prevent injury, keep the machine under control at all times.

1. Get into the operator's seat. Fasten the seat belt and pull the armrest downward.
2. Start the engine.
3. Disengage the parking brake.
4. Move the speed/direction control lever to the REVERSE position.

The backup alarm (if equipped) should sound immediately. The backup alarm should continue to sound until the speed/direction control lever is returned to the HOLD position or to the FORWARD position.

i00993589

Battery - Recycle

SMCS Code: 1401-561

Always recycle a battery. Never discard a battery.

Always return used batteries to one of the following locations:

- A battery supplier
- An authorized battery collection facility
- Recycling facility

i01719520

Battery or Battery Cable - Inspect/Replace

SMCS Code: 1401-040; 1401-510; 1401-561;
1402-040; 1402-510

1. Turn the engine start switch to the OFF position. Turn all switches to the OFF position.

2. Disconnect the negative battery cable from the starter.

Note: Do not allow the disconnected battery cable to contact the frame of the machine.

3. Disconnect the negative battery cable at the battery.
4. Perform the necessary repairs. Replace the cable or the battery, as needed.
5. Connect the negative battery cable at the battery.
6. Connect the battery cable to the starter of the machine.

7. Install the engine start switch key.

Repeat the process for the positive battery cable.

i01851684

Belts - Inspect/Adjust/Replace

SMCS Code: 1357-025; 1357-040; 1357-510

If a new belt is installed, check the belt adjustment after 30 minutes of operation. A belt is considered to be used after 30 minutes of operation.

1. Stop the engine in order to inspect the belt.
2. Open the engine access door. Refer to Operation and Maintenance Manual, "Access Doors and Covers".

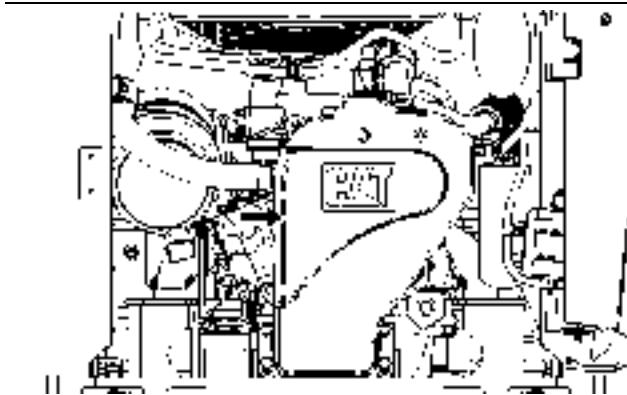

Illustration 94

g00943360

3. Remove the guard for the V-belt.

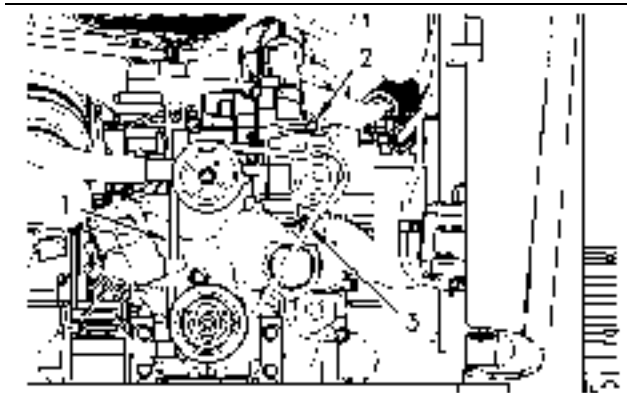

Illustration 95

g00943363

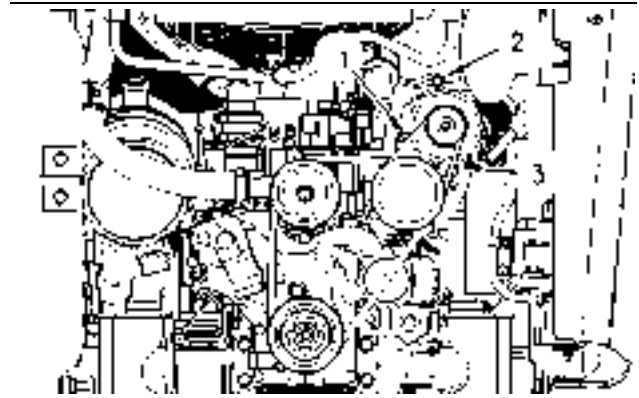

Illustration 96

g00953881

4. Inspect the condition of the belt (1) and the adjustment of the belt. The belt should deflect 10 mm (0.39 inch) under a straight pull of 44 N (10 lb). This measurement should be taken between the alternator pulley and the crankshaft pulley.

Note: A 144-0235 Borroughs Belt Tension Gauge may be used to measure belt tension. This measurement should be taken between the alternator pulley and the crankshaft pulley. Refer to the following table for belt tension.

Table 18

Belt Tension Initial	Belt Tension Used
534 ± 22 N (120 ± 5 lb)	400 ± 44 N (90 ± 10 lb)

5. Loosen the mounting bolt (2). Loosen the adjusting locknut (3).
6. Move the alternator until the correct tension is reached.
7. Tighten the adjusting locknut. Tighten the mounting bolt.
8. Recheck the belt deflection. If the amount of deflection is incorrect, repeat step 4 to step 7.
9. Install the guard for the V-belt.
10. Close the engine access door.

i01988720

Bogie and Idler - Inspect/Replace

SMCS Code: 4159-040; 4159-510; 4192-040;
 4192-510

Clean the undercarriage before inspecting the bogies and the idlers.

Inspect the bogies and idlers for damage and wear.

Note: Minor damage to the rubber on the bogies and idlers is acceptable. Minor damage includes nicks, cuts, small pieces that are missing, and small grooves. This minor damage is normal and acceptable. Minor damage will not adversely affect machine performance.

The bogies and the idlers should be replaced when the damage to the rubber wheels adversely affects machine performance. Replace the bogies and the idlers when the rubber is worn beyond the minimum specifications that are listed below.

Note: The tubes for the bogies and the tubes for the idlers on the 267B, 277B and 287B contain oil. Inspect the tubes for leaks. If a leak is suspected, the oil level should be checked. Refer to Operation and Maintenance Manual, "Bogie and Idler Oil Level - Check".

Table 19

Bogie Wheels and Idler Wheels Wear Limits 247B and 257B		
	Minimum Width	Minimum Thickness
254 mm (10 inch)	48 mm (1.9 inch)	3 mm (0.1 inch)
356 mm (14 inch)	48 mm (1.9 inch)	3 mm (0.1 inch)

Table 20

Bogie Wheels and Idler Wheels Wear Limits 267B, 277B and 287B		
	Minimum Width	Minimum Thickness
254 mm (10 inch) One-Piece Wheel and Two-Piece Wheel	32 mm (1.3 inch)	3 mm (0.1 inch)
356 mm (14 inch) One-Piece Wheel and Two-Piece Wheel	45 mm (1.8 inch)	3 mm (0.1 inch)

Replacement for the 247B and 257B

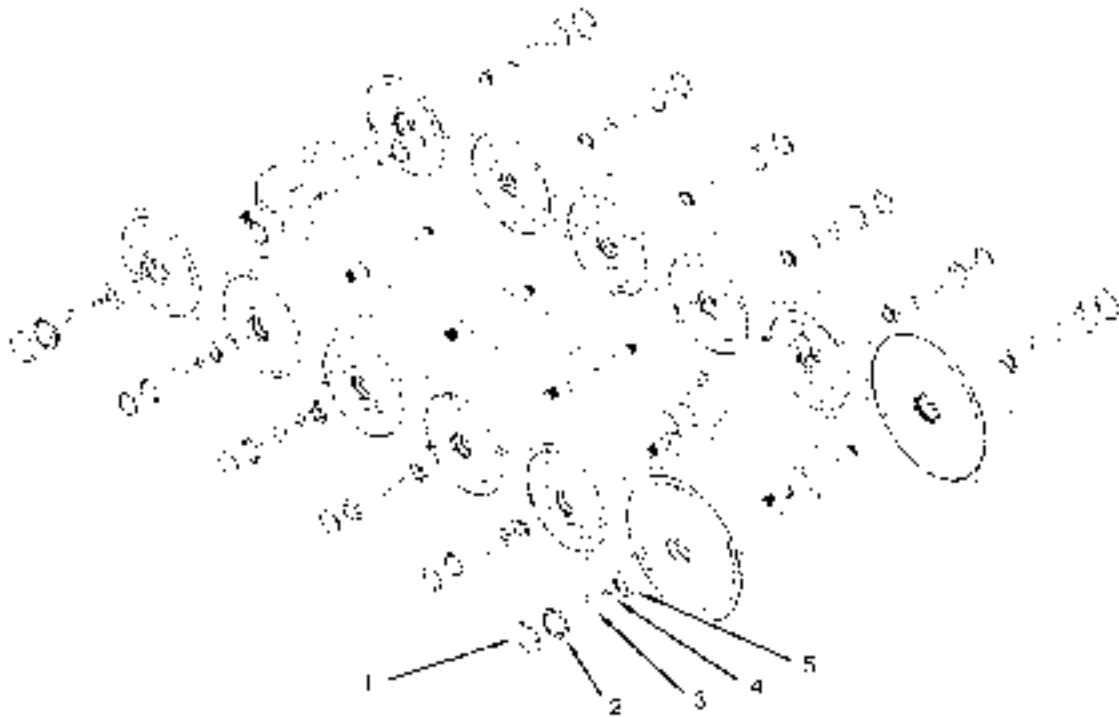

Illustration 97

g01029962

1. Remove the track. Refer to Operation and Maintenance Manual, "Track (Rubber) - Remove/Replace".
 2. Remove the retaining ring (1) and the dust cap (2).
 3. Remove the nut (3) and the washer (4).
- Note:** When you reinstall the nut (3), tighten the nut to the following torque 168 ± 30 N·m (124 ± 22 lb ft).
4. Remove the bearing (5).

Note: When you reinstall the bearing (5) lubricate the bearing with 1P-0808 Multipurpose Grease.

Replacement for the 267B and 277B

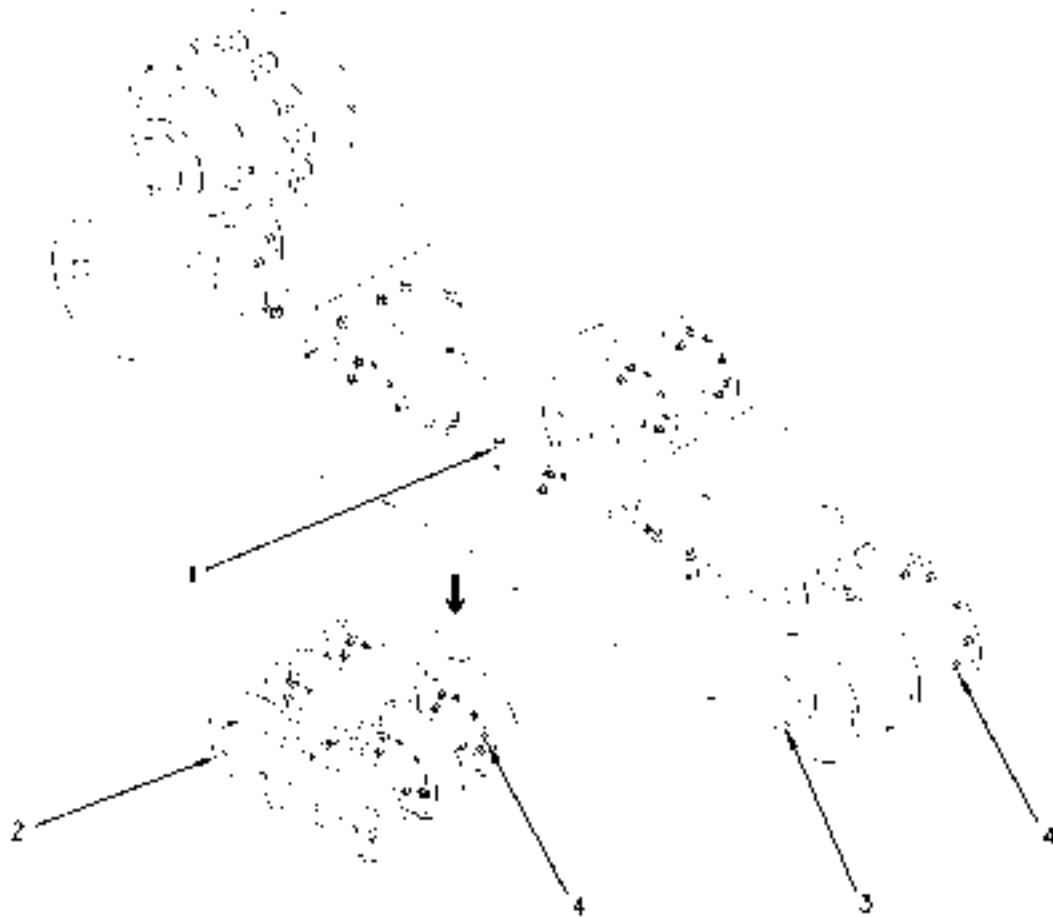

Illustration 98

g00955323

1. Remove the track. Refer to Operation and Maintenance Manual, "Track (Rubber) - Remove/Replace".
2. In order to remove a bogie group, remove the four bolts, lockwashers, and locknuts (1). In order to remove an idler group, remove the four bolts, lockwashers (3) and the plates. An idler group can be removed at this point.

Note: When you reinstall the four bolts (1) tighten the bolts to the following torque 120 ± 20 N·m (89 ± 15 lb ft). When you reinstall the four bolts (3) tighten the bolts to the following torque 95 ± 10 N·m (70 ± 7 lb ft).

3. Raise the side of the machine so that the bogie group can be removed from the bottom of the undercarriage.
4. Remove the four bolts, lockwashers (2) and the plates that retain the bogies.

Note: When you reinstall the four bolts, tighten the bolts to the following torque 95 ± 10 N·m (70 ± 7 lb ft).

5. Remove the bolts, lockwashers and locknuts (4) that retain the bogie or the idler. Remove the bogie or the idler.

Note: When you reinstall the bolts, tighten the bolts to the following torque 25 ± 6 N·m (18 ± 4 lb ft).

6. Reverse steps in order to reassemble the components. Use the special torques that are noted.

Replacement for the 287B

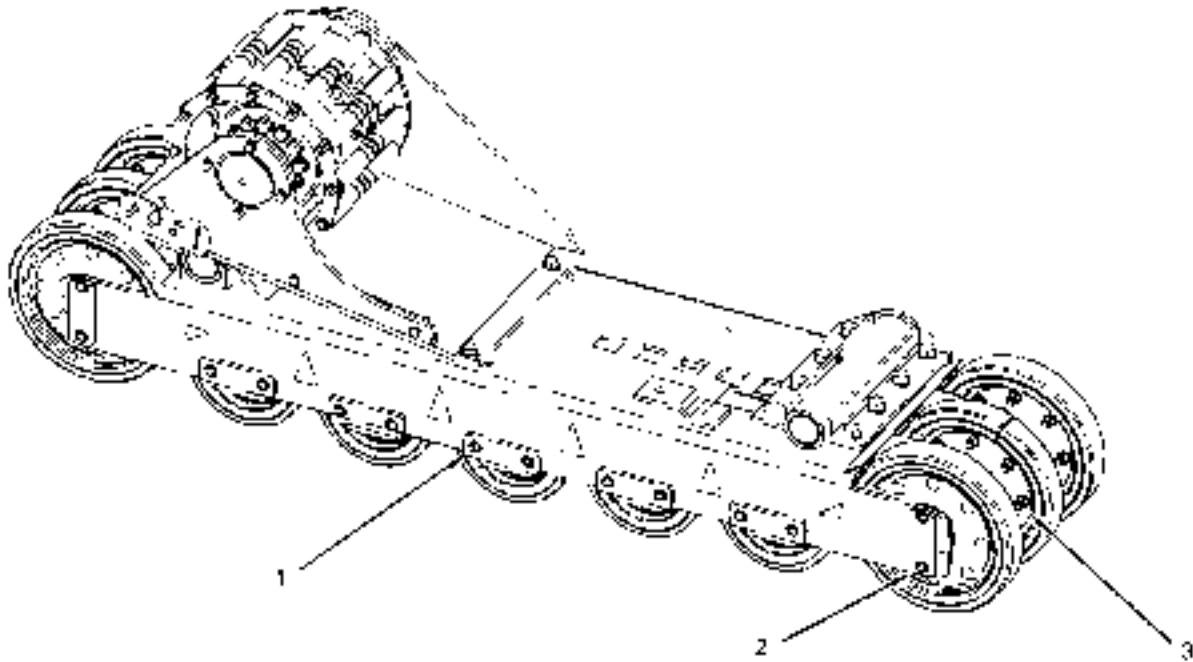

Illustration 99

g01030397

i02429710

1. In order to remove a bogie group, remove the four bolts, lockwashers, locknuts (1) and plates. In order to remove an idler group, remove the four bolts, lockwashers (2) and plates. An idler group can be removed at this point.

Note: When you reinstall the four bolts (1) and (2) tighten the bolts to the following torque 50 ± 10 N·m (37 ± 7 lb ft).

2. Raise the side of the machine so that the bogie group can be removed from the bottom of the undercarriage.
3. Remove the bolts, lockwashers and locknuts (3) that retain the bogie or the idler. Remove the bogie or the idler.

Note: When you reinstall the bolts, tighten the bolts to the following torque 25 ± 6 N·m (18 ± 4 lb ft).

4. Reverse steps in order to reassemble the components. Use the special torques that are noted.

Bogie and Idler Oil Level - Check

SMCS Code: 4159-535-OC; 4192-535-OC

S/N: CNC1-Up

S/N: CMP1-Up

S/N: CNY1-Up

Note: Inspect the seals on the tubes for the bogies and the idlers during the walk around inspection. If a seal is leaking, replace the seal.

Note: The 267B (S/N: CYC 954-UP), 277B (S/N: MDH 3315-UP), and 287B (S/N: ZSA 2205-UP) have sealed bearings. The bogie is maintenance free. If maintenance is required on the bogie, please refer to your Caterpillar dealer.

WARNING

Personal injury or death can result from servicing the track.

The machine must be on a hard, level surface before the track is removed or personal injury or death could occur.

1. Park the machine on a hard, level surface.

WARNING

Personal injury or death can result from improper lifting or blocking.

When a jack is used to lift the machine, stand clear of the area. Use a jack that is rated for the correct capacity to lift the machine. Install blocks or stands before performing any work on the machine.

2. Remove the track. Refer to Operation and Maintenance Manual, "Track (Rubber) - Remove/Replace" for the correct procedure.



Illustration 100

g00873251

3. Clean the area around the filler plug for the tube for the bogie or the idler. Remove the filler plug.
4. Rotate the tube so that the filler plug hole is approximately level with the ground. The oil level should show at the bottom of the filler plug hole.

Note: The oil level will be low if the seals in the tube are leaking. If the oil level is low, replace the oil seals in the tube and refill the tube. See Operation and Maintenance Manual, "Capacities (Refill)".

5. Apply 5P-3413 Pipe Sealant to the threads of the filler plug. Install the filler plug.
6. Repeat the procedure on each tube for the bogie and the idler.

i01743875

Bucket Cutting Edges - Inspect/Replace

SMCS Code: 6801-040; 6801-510

WARNING

Personal injury or death can result from bucket falling.

Block the bucket before changing bucket cutting edges.

1. Lower the lift arms fully. Tilt back the bucket so that the bucket cutting edge is accessible.
2. Place blocks under the raised edge of the bucket.
3. Remove the bolts. Remove the cutting edge and the end bits.
4. Clean the contact surfaces.
5. Use the opposite side of the cutting edge, if this side is not worn.
6. Install a new cutting edge, if both edges are worn.
7. Install the bolts.
8. Remove the blocks that are under the bucket.
9. After a few hours of operation, check the bolts for proper torque.

i01764331

Bucket Tips - Inspect/Replace

SMCS Code: 6805-040; 6805-510

WARNING

Personal injury or death can result from bucket falling.

Block the bucket before changing bucket cutting edges.

1. Lower the lift arms fully. Tilt back the bucket so that the bucket tips are accessible.
2. Place blocks under the raised edge of the bucket.
3. Remove the mounting bolts. Remove the bucket tips.

4. Clean the mounting surface.
5. Replace the bucket tips.
6. Install the bolts.
7. Remove the blocks that are under the bucket.
8. After a few hours of operation, check the bolts for proper torque.

i01962545

Cab Air Filter - Clean/Replace (If Equipped)

SMCS Code: 7342-070; 7342-510

Fresh Air Filter

1. Raise the loader lift arms. Install the brace for the loader lift arm. Refer to Operation and Maintenance Manual, "Loader Lift Arm Brace Operation".



Illustration 101

g01019732

2. Remove the filter cover.
3. Remove the seal from the cover and inspect the seal. If the seal is damaged replace the seal.
4. Remove the air filter element from the cover and clean the filter element with low pressure air. Replace the element if the element is damaged.
5. Install the seal onto the filter cover and install the filter element.
6. Install the filter cover on the machine.
7. Remove the brace for the loader lift arms and return the brace to the stored position. Refer to Operation and Maintenance Manual, "Loader Lift Arm Brace Operation".

Recirculation Filter

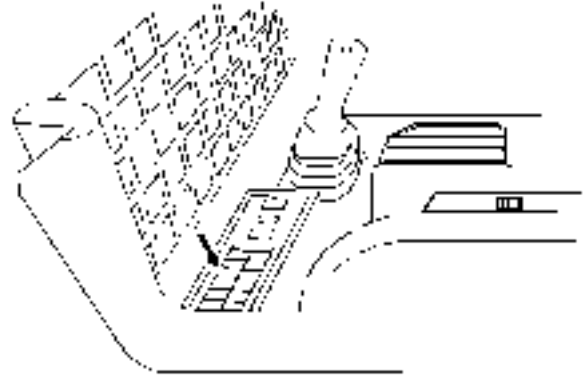

Illustration 102

g01024691

1. Remove the cover in order to access the air filter element.
2. Remove the air filter element and clean the element with soap and water. Replace the element if the element is damaged.
3. Install the element and replace the cover.

i01879977

Circuit Breakers and Fuses - Reset/Replace

SMCS Code: 1417-510; 1420-529

Fuses – Fuses protect the electrical system from damage that is caused by overloaded circuits. Replace the fuse if the element separates. If the element of a new fuse separates, check the circuit. Repair the circuit, if necessary.

NOTICE

Replace the fuses with the same type and size only. Otherwise, electrical damage can result.

If it is necessary to replace fuses frequently, an electrical problem may exist. Contact your Caterpillar dealer

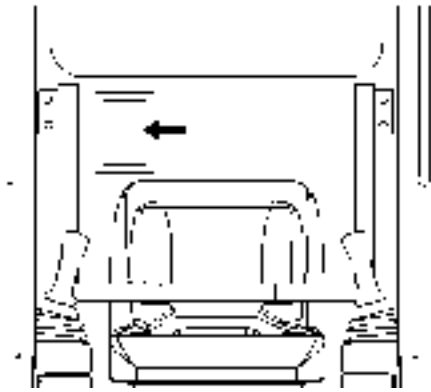

Illustration 103

g00895355

Remove the cover for the fuse panel.

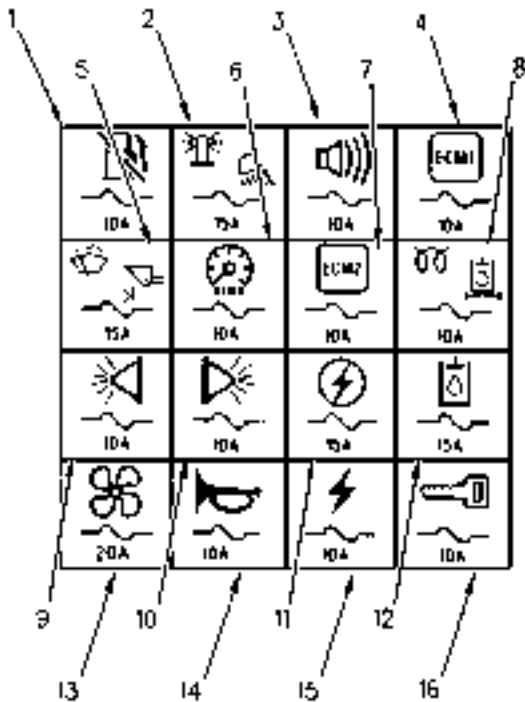

Illustration 104

g00793941

- (1) Fuel Shutoff
- (2) Rear Flood Lamps
- (3) Backup Alarm
- (4) Interlock Control
- (5) Wiper
- (6) Gauges
- (7) Auxiliary Hydraulic Control

- (8) Cold Start and Hydraulic Filter
- (9) Left Tail Lamp
- (10) Right Tail Lamp
- (11) Auxiliary tools
- (12) Fourth Function
- (13) Heater
- (14) Horn
- (15) Miscellaneous Power
- (16) Key Switch

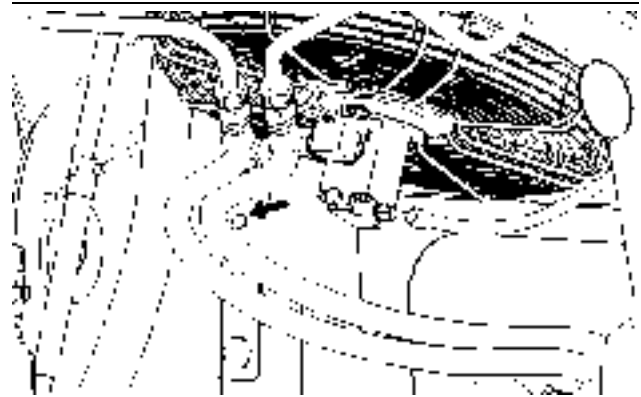

Illustration 105

g00960137

The main circuit breaker is located in the engine compartment on the left side.

i01947443

Cooling System Coolant (ELC) - Change

SMCS Code: 1395-044-NL



Pressurized system: Hot coolant can cause serious burn. To open cap, stop engine, wait until radiator is cool. Then loosen cap slowly to relieve the pressure.

NOTICE

Mixing ELC with other products will reduce the effectiveness of the coolant.

This could result in damage to cooling system components.

If Caterpillar products are not available and commercial products must be used, make sure they have passed the Caterpillar EC-1 specification for pre-mixed or concentrate coolants and Caterpillar Extender.

Note: The machine was shipped from the factory with Extended Life Coolant (ELC) in the cooling system.

For information about the addition of Extender to your cooling system, see the Operation and Maintenance Manual, "Cooling System Coolant (ELC) Extender - Add" or consult your Caterpillar dealer.

Drain the coolant whenever the coolant is dirty or whenever the coolant is foaming.

The radiator cap is located under the radiator guard on the top of the engine compartment.

Allow the machine to cool before you change the coolant.

1. Open the engine access door. Refer to Operation and Maintenance Manual, "Access Doors and Covers".
2. Raise the radiator guard. Refer to Operation and Maintenance Manual, "Radiator Tilting".

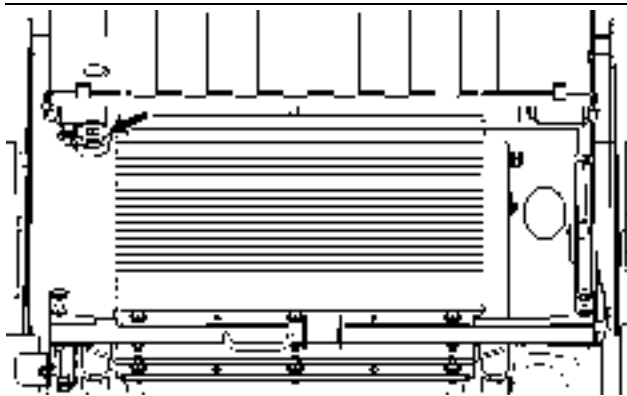

Illustration 106

g00956151

3. Slowly loosen the radiator cap in order to relieve system pressure. Remove the radiator cap.

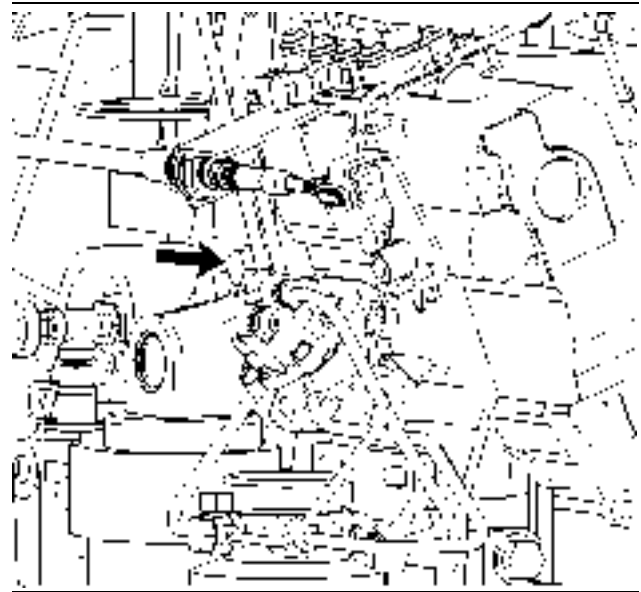

Illustration 107

g00954319

4. The drain plug for the coolant is located on the left side of the engine block. Remove the drain plug and allow the coolant to drain into a suitable container.
5. Install the drain plug.
6. Replace the thermostat. See Operation and Maintenance Manual, "Cooling System Water Temperature Regulator - Replace" for the process for replacing the thermostat.
7. Add the coolant solution. Refer to Operation and Maintenance Manual, "Capacities - (Refill)". Refer to Special Publication, SEBU6250, "Caterpillar Machine Fluids Recommendations".

Note: Premix the coolant solution before filling the cooling system. The coolant solution should contain 50 percent coolant and 50 percent distilled water.

Note: Add the coolant solution at a maximum rate of five liters per minute. This will reduce the chance of trapping air inside the engine block. A large amount of trapped air can cause localized heating to occur upon start-up. Localized heating may result in engine damage, which may lead to failure of the engine.

8. Start the engine. Run the engine without the radiator cap until the thermostat opens and the coolant level stabilizes.

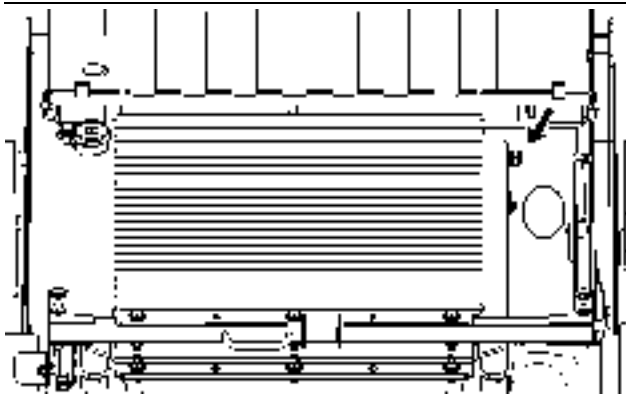

Illustration 108

g00956179

9. Maintain the coolant level in the sight gauge. The sight gauge is located on the right side of the radiator.
10. Stop the engine. Inspect the radiator cap and the gasket. Replace the cap if the cap or the gasket is damaged. Install the radiator cap.
11. Pull the radiator guard downward.
12. Close the engine access door.

i01954846

Cooling System Coolant Extender (ELC) - Add

SMCS Code: 1352-544-NL

WARNING

Pressurized system: Hot coolant can cause serious burn. To open cap, stop engine, wait until radiator is cool. Then loosen cap slowly to relieve the pressure.

When a Caterpillar Extended Life Coolant is used, an extender must be added to the cooling system periodically.

1. Open the engine access door. Refer to Operation and Maintenance Manual, "Access Doors and Covers".
2. Tilt the radiator guard upward. Refer to Operation and Maintenance Manual, "Radiator Tilting".

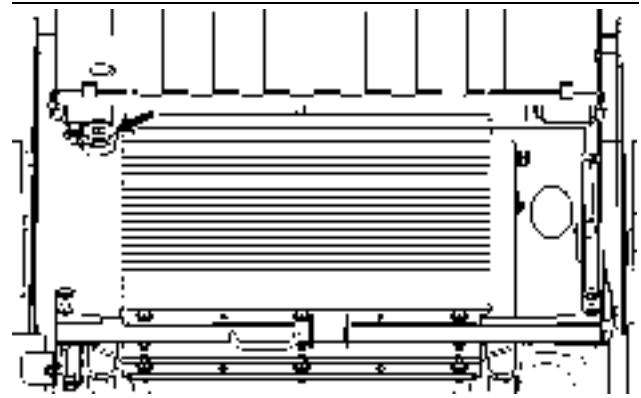

Illustration 109

g00956151

3. Slowly loosen the radiator cap in order to relieve system pressure. Remove the radiator cap.
4. If necessary, drain enough coolant from the radiator in order to allow the addition of the coolant additive.
5. Add 0.17 L (0.18 qt) of cooling system additive.
6. Inspect the radiator cap and the gasket. If the cap or the gasket is damaged, replace the cap. Install the radiator cap.

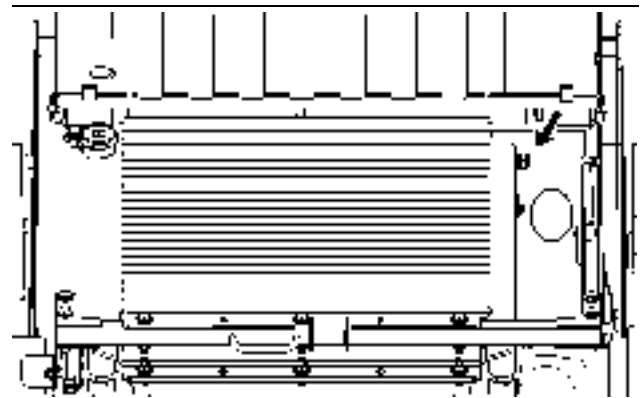

Illustration 110

g00956179

7. Check the coolant level in the sight gauge on the radiator. The sight gauge is located on the right side of the radiator. Maintain the coolant level to the top of the sight gauge with the radiator in the LOWERED position.
8. Tilt the radiator guard downward.
9. Close the engine access door.

For additional information on the addition of extender, see Special Publication, SEBU6250, "Caterpillar Machine Fluids Recommendations".

i01874850

Cooling System Level - Check

SMCS Code: 1350-040-HX; 1350-535-FLV;
1382-070; 1382-510

WARNING

Pressurized system: Hot coolant can cause serious burn. To open cap, stop engine, wait until radiator is cool. Then loosen cap slowly to relieve the pressure.

1. Open the engine access door. Refer to Operation and Maintenance Manual, "Access Doors and Covers".
2. Tilt the radiator guard upward. Refer to Operation and Maintenance Manual, "Radiator Tilting".

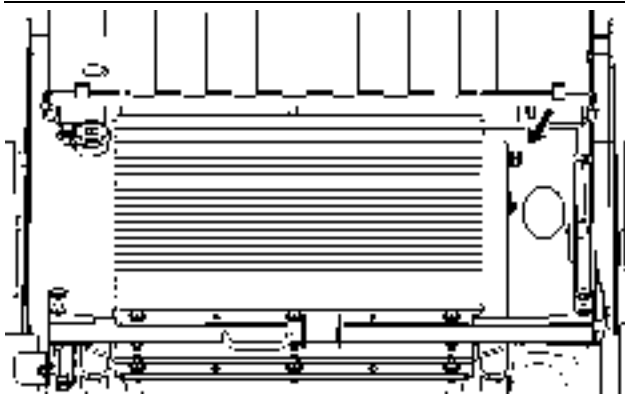

Illustration 111

g00956179

3. Maintain the coolant to the top of the sight gauge with the radiator in the LOWERED position. The sight gauge is located on the right side of the radiator.

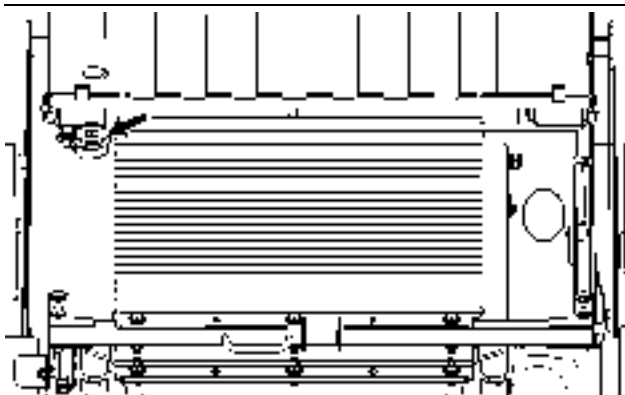

Illustration 112

g00956151

4. If you need to add coolant to the radiator, the radiator cap is located on the upper left corner of the radiator. Remove the radiator cap slowly in order to relieve system pressure.

Note: Inspect the cooling system hoses for any leaks, cracks, or signs of deterioration. Replace any damaged hoses.

5. Inspect the radiator cap and the gasket. Replace the cap if the cap or the gasket is damaged. Install the radiator cap.
6. Tilt the radiator guard downward.

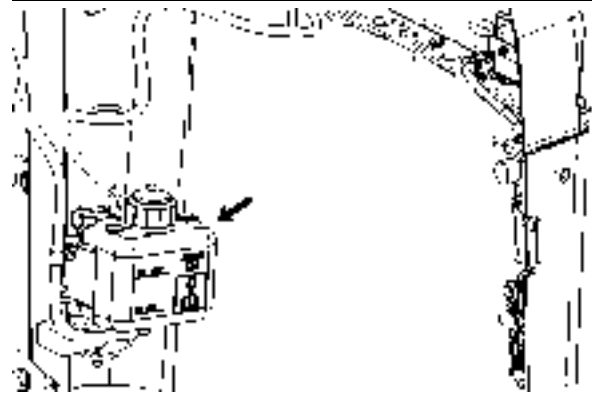

Illustration 113

g00954176

7. Maintain the coolant level in the coolant reservoir between the "MIN" and "MAX" lines on the reservoir tank.
8. Close the engine access door.

i01954858

Cooling System Water Temperature Regulator - Replace

SMCS Code: 1355-510; 1393-010

Replace the thermostat on a regular basis in order to reduce the chance of unscheduled downtime and of problems with the cooling system. Failure to replace the engine's thermostat on a regularly scheduled basis could cause severe engine damage.

The thermostat should be replaced after the cooling system has been cleaned. Replace the thermostat while the cooling system is completely drained or while the cooling system coolant is drained to a level that is below the thermostat housing.

Caterpillar engines incorporate a shunt design cooling system. It is mandatory to always operate the engine with a thermostat.

1. Open the engine access door. Refer to Operation and Maintenance Manual, "Access Doors and Covers".
2. Drain the coolant from the machine. See Operation and Maintenance Manual, "Cooling System Coolant (ELC) - Change" for the procedure to drain the cooling system.



Illustration 114

g00943402

3. Loosen the hose clamp (1) and remove the hose from the thermostat housing assembly (2).
4. Remove the two bolts (3) from the thermostat housing assembly. Remove the thermostat housing assembly.
5. Remove the seal and the thermostat from the thermostat housing assembly.
6. Install a new thermostat and a new seal. Install the thermostat housing assembly on the engine cylinder head.
7. Install the hose. Tighten the hose clamp.
8. Refill the cooling system. See Operation and Maintenance Manual, "Capacities - (Refill)". Refer to Special Publication, SEBU6250, "Caterpillar Machine Fluid Recommendations" for coolant information.
9. Close the engine access door.

i01947517

Engine Air Filter Primary Element - Clean/Replace

SMCS Code: 1054-070-PY; 1054-510-PY

NOTICE

Never service the air cleaner when the engine is running, to avoid engine damage.

NOTICE

Caterpillar recommends certified air filter cleaning services that are available at Caterpillar dealers. The Caterpillar cleaning process uses proven procedures to assure consistent quality and sufficient filter life.

Observe the following recommendations if you attempt to clean the filter element:

Never tap or strike the filter element in order to remove dust.

Never wash the filter element.

Use low pressure compressed air in order to remove the dust from the filter element. Air pressure must not exceed 206 kPa (30 psi). Direct the air flow up the pleats and down the pleats from the inside of the filter element. Take extreme care in order to avoid tearing or voiding the pleats.

Service the air cleaner filter elements when the yellow piston on the engine air filter service indicator enters the red zone. Refer to Operation and Maintenance Manual, "Engine Air Filter Service Indicator - Inspect".

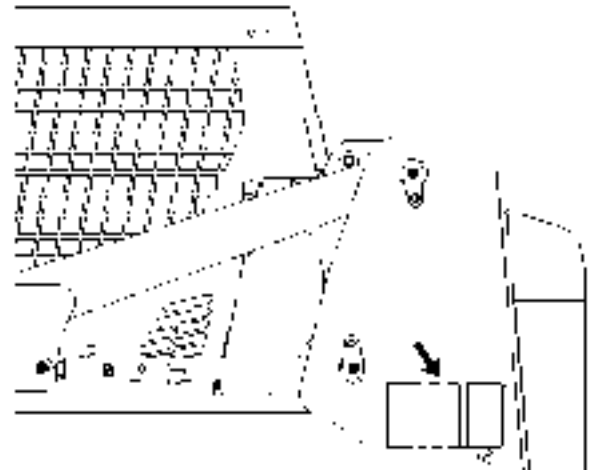

Illustration 115

g00891467

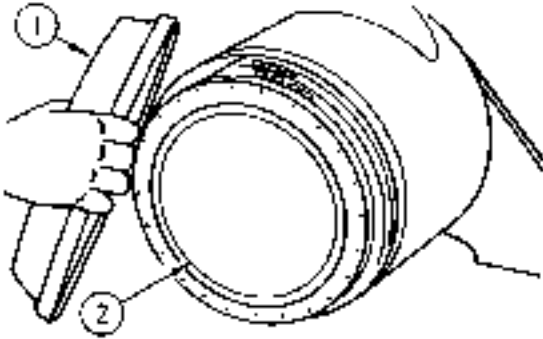

Illustration 116

g00101864

1. Remove the air cleaner housing cover (1).
2. Remove the primary filter element (2).
3. Install a clean filter element and install the cover.
4. Reset the engine air filter service indicator.

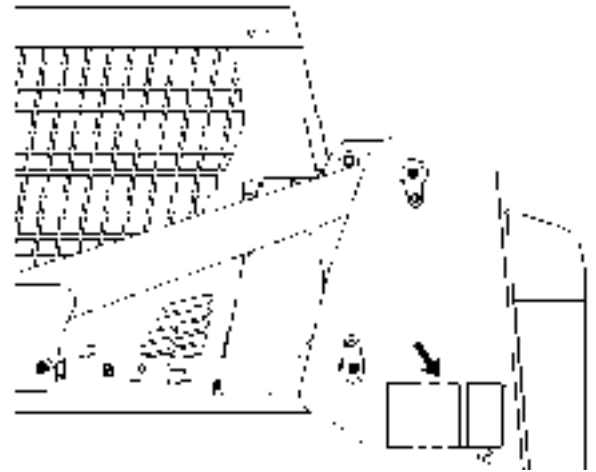

Illustration 117

g00891467

i01741365

Engine Air Filter Secondary Element - Replace

SMCS Code: 1054-510-SE

NOTICE

Always replace the secondary filter element. Never attempt to reuse it by cleaning.

The secondary filter element should be replaced at the time the primary element is serviced for the third time.

The secondary filter element should also be replaced if the yellow piston in the filter element indicator enters the red zone after installation of a clean primary element, or if the exhaust smoke is still black.

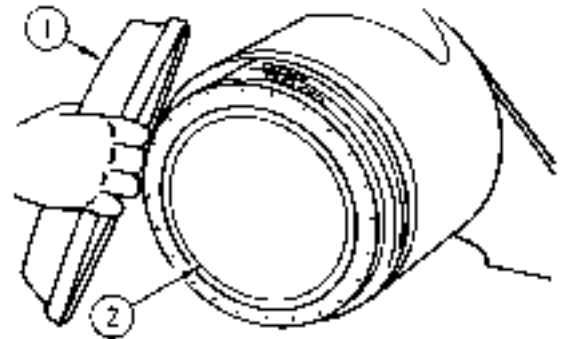

Illustration 118

g00101864

1. Remove the air cleaner housing cover (1).
2. Remove the primary filter element (2).

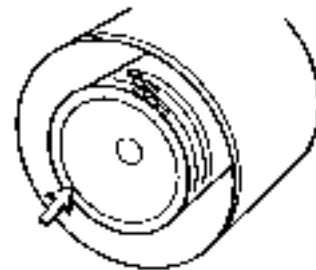

Illustration 119

g00038606

3. Remove the secondary filter element.

4. Cover the air inlet opening. Clean the inside of the air cleaner housing.
5. Inspect the gasket between the air inlet pipe and the air cleaner housing. Replace the gasket if the gasket is damaged.
6. Uncover the air inlet opening. Install a new secondary element.
7. Install the primary element and the air cleaner housing cover.
8. Reset the engine air filter service indicator. Refer to Operation and Maintenance Manual, "Engine Air Filter Service Indicator - Inspect".

i02108294

Engine Air Filter Service Indicator - Inspect

SMCS Code: 7452-040

NOTICE

Service the air cleaner only with the engine stopped. Engine damage could result.

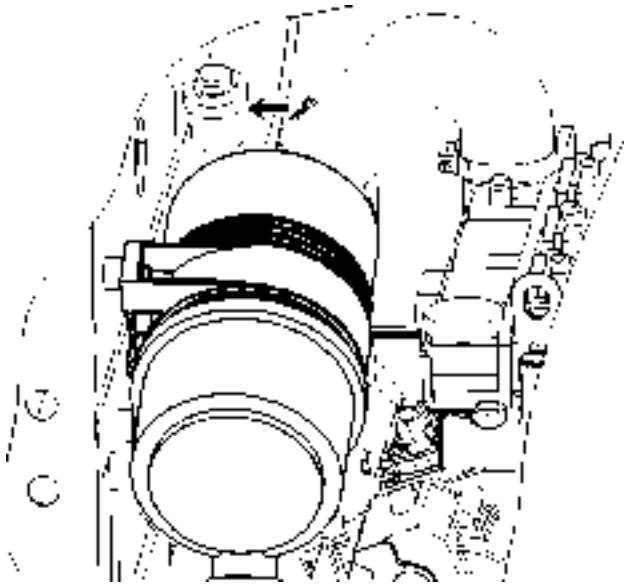

Illustration 120

g00929221

Type 1

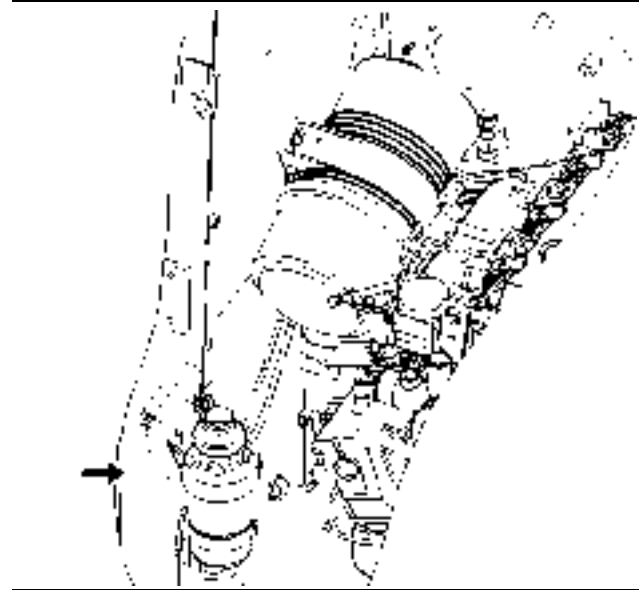

Illustration 121

g00929224

Type 2

1. Mount the machine.
 2. Fasten the seat belt. Lower the armrest.
 3. Start the engine.
 4. Run the engine at high idle.
 5. Stop the engine.
 6. Open the engine access door. Refer to Operation and Maintenance Manual, "Access Doors and Covers".
 7. Tilt the radiator upward if it is necessary. Refer to Operation and Maintenance Manual, "Radiator Tilting".
 8. Inspect the engine air filter service indicator. If the yellow piston in the filter service indicator enters the red zone, service the air cleaner.
- Note:** See the Operation and Maintenance Manual, "Engine Air Filter Primary Element - Clean/Replace". See the Operation and Maintenance Manual, "Engine Air Filter Secondary Element - Replace".
9. Reset the engine air filter service indicator.
 10. Tilt the radiator downward.
 11. Close the engine access door.

i01978979

i01819955

Engine Compartment - Clean

SMCS Code: 1000-070

Inspect the engine compartment for dirt buildup or debris. Remove any dirt or debris from the engine compartment.

1. Open the engine access door. Refer to Operation and Maintenance Manual, "Access Doors and Covers".
2. Remove any debris or dirt from the engine compartment.

Note: Use care when you clean the engine compartment. Damage to the machine may occur.

3. Close the engine access door.

Air Conditioning Condenser

The air conditioning condenser is located at the back of the engine compartment. Cleaning the air conditioning condenser will maintain optimum performance of the air conditioning system.

Use low pressure water in order to clean the condenser.

Engine Crankcase Breather (Closed Circuit) - Replace

SMCS Code: 1317-510

S/N: CNC1-Up

S/N: CNY1-Up

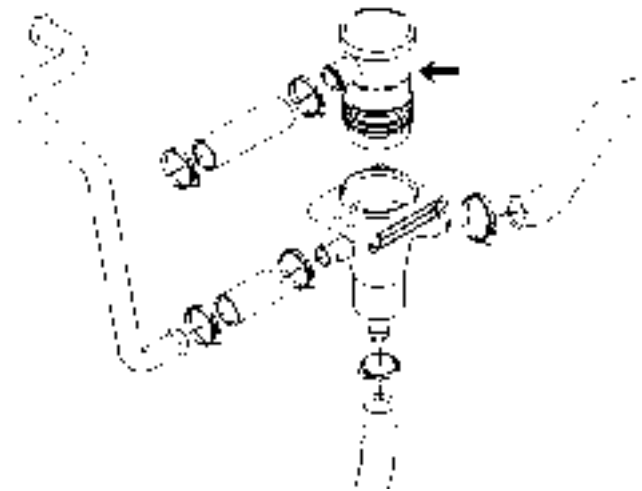

Illustration 122

g00929163

The breather is located on the left side of the engine on turbocharged machines.

NOTICE

Ensure that the breather pipe connections are tight. Do not overfill the engine crankcase. If there is too much oil in the crankcase oil may enter the breather. Oil entering the breather may cause the engine speed to increase rapidly without control.

1. Firmly grasp the breather and pull up on the breather in order to remove the breather.
2. Remove the breather hoses. Clean the hoses with nonflammable solvent.
3. Install a new breather. Ensure that the breather is properly seated in the base.
4. Install the breather hoses. Ensure that the connections are tight.

i01878882

Engine Crankcase Breather - Clean

SMCS Code: 1317-070

S/N: CML1-Up

S/N: CMM1-Up

S/N: CMP1-Up

Note: This type of engine crankcase breather is used on naturally aspirated engines only.

Note: Ensure that the area around the vent hole on the breather cover is clean and that the vent hole is not restricted. Ensure that the breather hose is installed correctly, so that the hose does not contact other parts. Ensure that the components of the breather assembly are seated in the correct positions. Otherwise, engine damage could result.

1. Open the engine access door. Refer to Operation and Maintenance Manual, "Access Doors and Covers".
2. Tilt the radiator upward. Refer to Operation and Maintenance Manual, "Radiator Tilting".

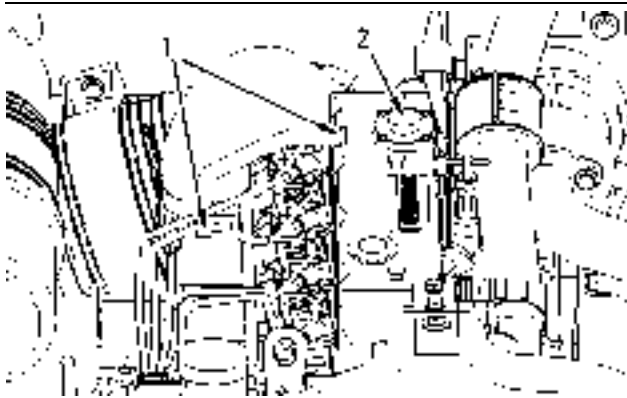

Illustration 123

g00956198

Breather location (2)

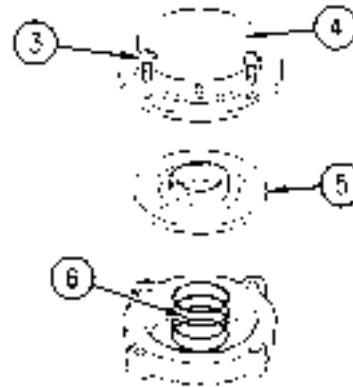

Illustration 124

g00822156

3. Loosen the hose clamps (1) for the breather hose. Remove the breather hose.
4. Remove the screws (3). Remove the breather cover (4).
5. Remove the diaphragm assembly (5). The diaphragm assembly consists of the diaphragm and the locating ring. Remove the spring (6).
6. Clean the following items with a clean, nonflammable solvent:
 - Breather
 - Breather cover
 - Diaphragm assembly
 - Location ring assembly
 - Spring
 - Breather hose
7. Allow the parts to dry. Pressure air may be used to dry the parts.
8. Inspect the breather hose for damage. Replace the breather hose, if necessary.
9. Install the elements of the breather. Install the breather element cover assembly.
10. Install the breather hose and tighten the hose clamps for the breather hose.
11. Tilt the radiator downward.
12. Close the engine access door.

i01878938

Engine Oil Level - Check

SMCS Code: 1348-535-FLV

NOTICE

Do not overfill the crankcase. Engine damage can result.

1. Stop the engine and allow the oil to drain back into the oil pan.
2. Open the engine access door. Refer to Operation and Maintenance Manual, "Access Doors and Covers".
3. Tilt the radiator upward. Refer to Operation and Maintenance Manual, "Radiator Tilting".

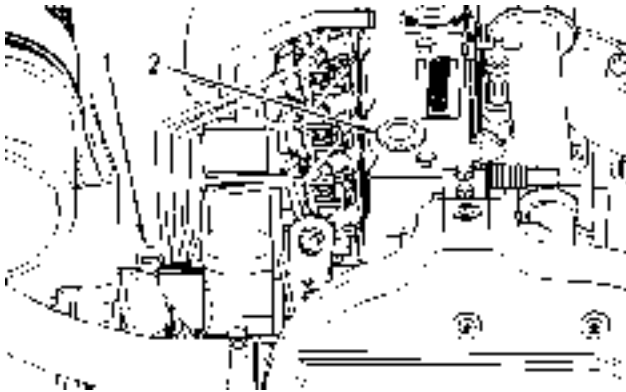

Illustration 125

g00956243



Illustration 126

g00850465

4. Maintain the oil level to the "FULL" mark (3) on the dipstick (1).
5. If necessary, remove the oil filler cap (2) and add oil.
6. Clean the oil filler cap and install the oil filler cap.
7. Tilt the radiator downward.

8. Close the engine access door.

i01850670

Engine Oil Sample - Obtain

SMCS Code: 1348-554-SM; 7542-008

Illustration 127

g00942687

The sampling port for the engine oil is located on the left side of the engine block.

i01878955

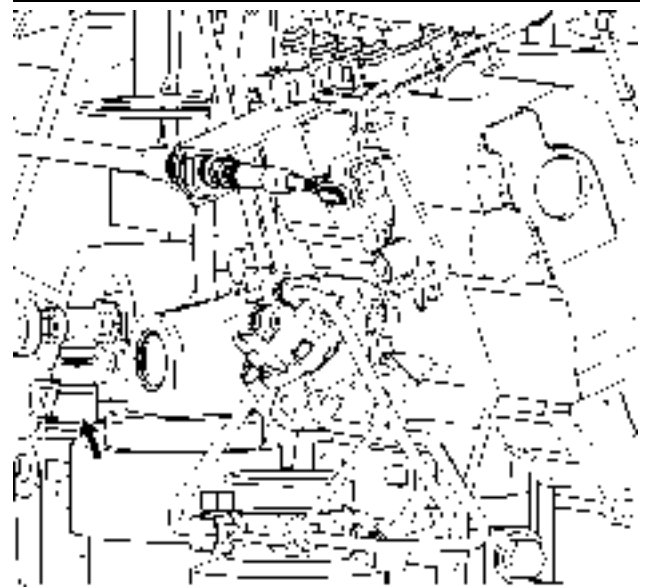
Engine Oil and Filter - Change

SMCS Code: 1308-510; 1348-044

The normal oil change interval for the machine is Every 500 Service Hours or every year when the following conditions are met:

- Caterpillar oil or API Specification CG-4 multigrade oil is used.
- Caterpillar filters are used.
- The altitude does not exceed 2300 m (7545 ft).
- Sulfur content in the fuel is between 0.05% and 0.50%.

An oil change interval of Every 250 Service Hours or every month is required when the following conditions occur:

- Caterpillar oil or API Specification CG-4 multigrade oil is not used.

- The altitude exceeds 2300 m (7545 ft).
- Sulfur content in the fuel is between 0.50% and 1.00%.

An oil change interval of Every 125 Service Hours is required when the following condition occurs:

- Sulfur content in the fuel is above 1.00%.

Refer to the results of the S-O-S oil analysis in order to determine if the oil change interval should be decreased. Consult your Caterpillar Dealer for detailed information regarding the optimum oil change interval.

1. Open the engine access door. Refer to Operation and Maintenance Manual, "Access Doors and Covers".
2. Tilt the radiator upward. Refer to Operation and Maintenance Manual, "Radiator Tilting".

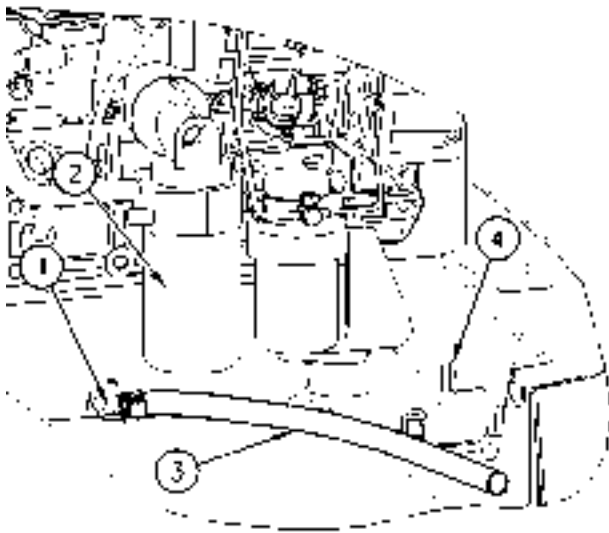

Illustration 128

g00895469

Note: The crankcase drain is located on the left side of the oil pan.

3. Pull the drain hose for the crankcase (3) through the opening in the rear of the machine (4) and remove the plug in the end of the drain hose.
4. Open the crankcase drain valve (1) and drain the oil into a suitable container. Close the crankcase drain valve. Install the plug in the drain hose.
5. Remove the filter element (2) with a strap type wrench. Refer to Operation and Maintenance Manual, "Oil Filter - Inspect" in order to inspect the used filter for debris.

6. Apply a thin film of clean engine oil to the sealing surface of the new filter element.
7. Install the new filter element by hand. When the gasket contacts the filter base, tighten the filter for an additional 3/4 turn.

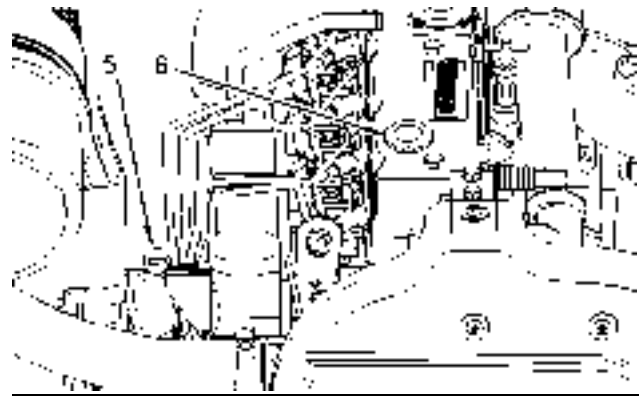

Illustration 129

g00956263

8. Remove the oil filler plug (6). Fill the crankcase with new oil. See Operation and Maintenance Manual, "Lubricant Viscosities" and Operation and Maintenance Manual, "Refill Capacities". Clean the oil filler plug and install the oil filler plug.
9. Start the engine and allow the oil to warm. Check for leaks.



Illustration 130

g00849728

10. Stop the engine and allow the oil to drain back into the oil pan. Fill the crankcase to the "FULL" mark on the dipstick (5). **Do not exceed the "FULL" mark on the dipstick.** Add oil or drain oil if it is necessary.
11. Tilt the radiator downward.
12. Close the engine access door.

i01752164

Engine Starting with Jump Start Cables

SMCS Code: 1000; 7000

WARNING

Batteries give off flammable fumes that can explode resulting in personal injury.

Prevent sparks near the batteries. They could cause vapors to explode. Do not allow the jump start cable ends to contact each other or the machine.

Do not smoke when checking battery electrolyte levels.

Electrolyte is an acid and can cause personal injury if it contacts skin or eyes.

Always wear eye protection when starting a machine with jump start cables.

Improper jump start procedures can cause an explosion resulting in personal injury.

Always connect the positive (+) to positive (+) and the negative (-) to negative (-).

Jump start only with an energy source with the same voltage as the stalled machine.

Turn off all lights and accessories on the stalled machine. Otherwise, they will operate when the energy source is connected.

NOTICE

To prevent damage to engine bearings and to electrical circuits when you jump start a machine, do not allow the stalled machine to touch the machine that is used as the electrical source.

Severely discharged maintenance free batteries do not fully recharge from the alternator after jump starting. The batteries must be charged to proper voltage with a battery charger. Many batteries thought to be unusable are still rechargeable.

Use only equal voltage for starting. Check the battery and starter voltage rating of your machine. Use only the same voltage for jump starting. Use of a welder or higher voltage damages the electrical system. This machine has a 12 volt starting system. Use only the same voltage for jump starting.

Refer to Special Instruction, SEHS7633, "Battery Test Procedure" available from your Caterpillar dealer, for complete testing and charging information.

1. Determine the reason that the engine will not crank. The Caterpillar Electronic Technician (ET) can be used to aid in troubleshooting if the machine is equipped with the auxiliary hydraulic control module.
2. Engage the parking brake. Lower the work tools to the ground. Refer to Operation and Maintenance Manual, "Equipment Lowering with Engine Stopped". Move all control levers to the HOLD or NEUTRAL position.
3. Turn the engine start switch to the OFF position and turn all accessory switches to the OFF position.
4. Move the machine that is being used as an electrical source near the stalled machine so that the jump start cables reach the stalled machine.
Do not allow the machines to contact each other.
5. Stop the engine of the machine that is being used as an electrical source. If you are using an auxiliary power source, turn off the charging system.
6. Ensure that battery caps on both machines are tight and correctly placed. Ensure that batteries in the stalled machine are not frozen.
7. Connect the positive jump start cable to the positive cable terminal of the discharged battery.

Do not allow the positive cable clamps to contact any metal except for the battery terminals.

8. Connect the other positive end of the jump start cable to the positive cable terminal of the electrical source.
9. Connect one negative end of the jump start cable to the negative cable terminal of the electrical source.
10. Connect the other negative end of the jump start cable to the engine block or to the frame of the stalled machine. **Do not connect the jump start cable to the battery post. Do not allow the jump start cables to contact the battery cables, the fuel lines, the hydraulic lines, or any moving parts.**
11. Start the engine of the machine that is being used as an electrical source or energize the charging system on the auxiliary power source.
12. Wait at least two minutes before you attempt to start the stalled machine. This will allow the battery in the stalled machine to partially charge.
13. Attempt to start the stalled engine. See Operation and Maintenance Manual, "Starting the Engine" for the correct starting procedure.
14. After the stalled engine starts, disconnect the negative jump start cable from the stalled machine.
15. Disconnect the negative jump start cable from the negative terminal of the electrical source.
16. Disconnect the positive jump start cable from the positive terminal of the electrical source.
17. Disconnect the positive jump start cable from the positive terminal of the stalled machine.
18. Conclude the failure analysis on the starting system of the stalled machine and/or on the charging system of the stalled machine. Check the machine while the engine is running and the charging system is in operation.

i01020861

Engine Valve Lash - Check

SMCS Code: 1105-025

Refer to the Service Manual for the complete adjustment procedure for the engine valve lash.

A qualified mechanic should adjust the engine valve lash and the fuel injector timing because special tools and training are required.

i00916186

Fuel Injection Timing - Check

SMCS Code: 1251-531

Note: The correct fuel timing specification is found on the Engine Information Plate. Fuel timing specifications may vary for different engine applications and/or for different power ratings.

A qualified mechanic should adjust the fuel injection timing because special tools and training are required.

Refer to the Service Manual for the complete adjustment procedure for the fuel injection timing. Refer to your Caterpillar dealer for the complete adjustment procedure for the fuel injection timing.

i01819808

Fuel System Filter - Replace

SMCS Code: 1261-510

NOTICE

Do not fill fuel filters with fuel before installing them. Contaminated fuel will cause accelerated wear to fuel system parts.

The fuel filter is located on the left side of the engine compartment.

1. Open the engine access door. Refer to Operation and Maintenance Manual, "Access Doors and Covers".

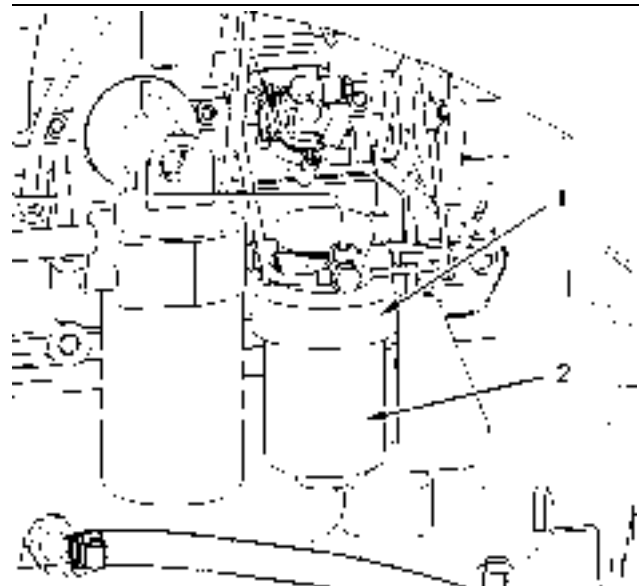

Illustration 131

Fuel Filter (Type 1)

g00943528

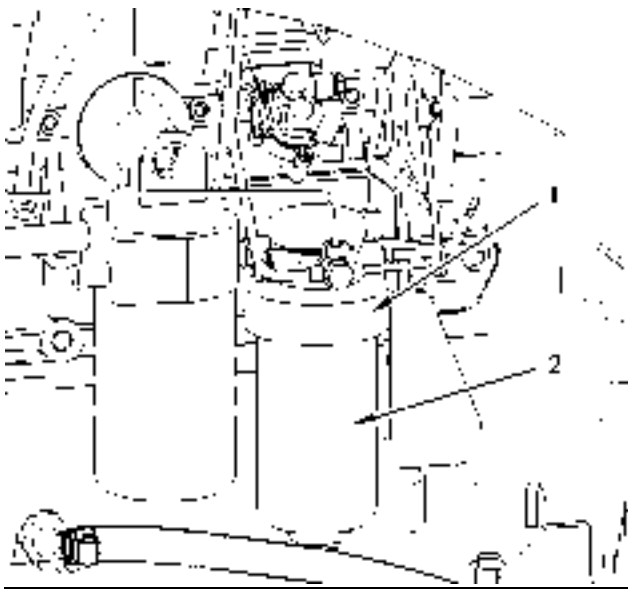

Illustration 132

g00954458

Fuel Filter/Water Separator (Type 2)

2. Support the filter element (2) and rotate the locking ring (1) counterclockwise. Remove the locking ring.
3. Remove the filter element. Inspect the fuel filter for debris by cutting the filter open. Discard the filter properly.
4. Clean the mounting base of the fuel filter. Remove any part of the old seal that remains on the mounting base of the fuel filter.
5. Coat the seal of the new fuel filter with clean diesel fuel.
6. Install the new fuel filter by hand. Rotate the locking ring clockwise. When the seal contacts the base, tighten the locking ring for an additional three quarters of a turn.
7. Prime the fuel system. Refer to Operation and Maintenance Manual, "Fuel System Priming Pump - Operate".
8. Close the engine access door.

i02099555

Fuel System Primary Filter (Water Separator) - Drain

SMCS Code: 1263-543

The fuel system water separator is located in the left side of the engine compartment.

1. Open the engine access door. Refer to Operation and Maintenance Manual, "Access Doors and Covers".

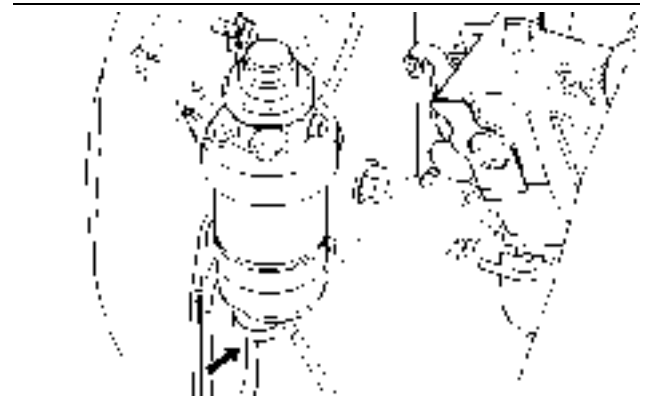

Illustration 133

g00954468

Water Separator Element



Illustration 134

g00954471

Fuel Filter/Water Separator

2. Loosen the drain valve on the bottom of the water separator. Allow the water and the sediment to drain into a suitable container.
3. Tighten the drain valve.
4. Close the engine access door.

i02099563

i01819495

Fuel System Primary Filter (Water Separator) Element - Replace

SMCS Code: 1260-510-FQ; 1263-510-FQ

S/N: CNC1-1199

S/N: CML1-Up

S/N: CMM1-Up

S/N: CMP1-699

The fuel filter/water separator for the fuel system is located in the engine compartment.

1. Open the engine access door. Refer to Operation and Maintenance Manual, "Access Doors and Covers".

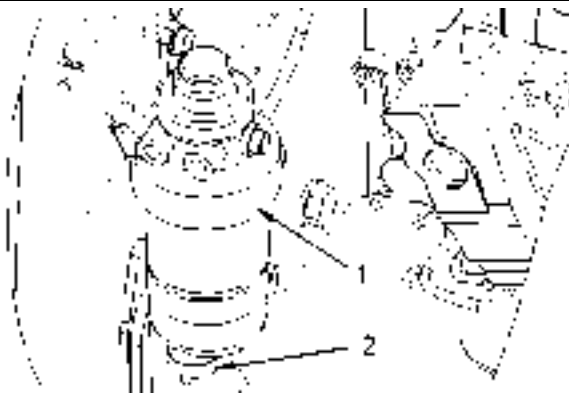

Illustration 135

g00954486

2. Open the drain on the fuel filter/water separator (2). Allow the water and fuel to drain into a suitable container.
3. Support the fuel filter/water separator and rotate the locking ring (1) counterclockwise. Remove the fuel filter/water separator.
4. Clean the mounting base for the fuel filter/water separator.
5. Install the new fuel filter/water separator. Rotate the locking ring clockwise in order to fasten the fuel filter/water separator to the mounting base.
6. Prime the fuel system in order to fill the fuel filter/water separator with fuel. Refer to Operation and Maintenance Manual, "Fuel System Priming Pump - Operate".
7. Close the engine access door.

Fuel System Priming Pump - Operate

SMCS Code: 1258-548

The fuel priming pump is located on the left side of the engine.



Illustration 136

g00943571

Fuel Priming Pump (Type 1)



Illustration 137

g00954466

Fuel Priming Pump (Type 2)

1. Open the engine access door. Refer to Operation and Maintenance Manual, "Access Doors and Covers".

Note: On type 1 systems, when the cam for the fuel pump is in the maximum lift position, the priming lever will not function. In this situation, the crankshaft must be turned one revolution.

2. Push down on the top of the fuel priming pump plunger and release the fuel priming pump plunger in order to operate the fuel priming pump. Operate the fuel priming pump plunger in order to fill the new filter element with fuel. Continue to pump until increased resistance is felt. This resistance will indicate that the filter element is full of fuel.

3. Start the engine. If the engine does not start, further priming is necessary. If the engine starts but the engine continues to misfire, further priming is necessary. If the engine starts but the engine continues to emit smoke, further priming is necessary.
4. If the engine starts but the engine runs rough, continue to run the engine at low idle. Continue to run the engine at low idle until the engine runs smoothly.
5. Close the engine access door.

i01819309

Fuel Tank Cap - Clean

SMCS Code: 1273-070-Z2

1. Remove the fuel cap.

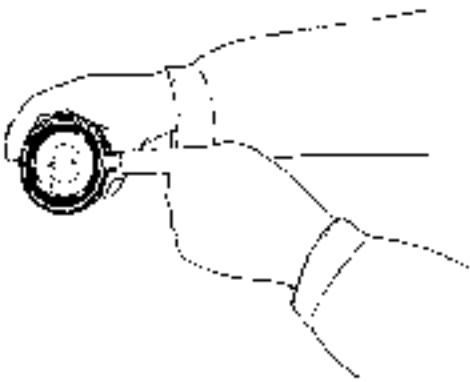

Illustration 138

g00104238

2. Inspect the cap. Replace the cap if the cap is damaged.
3. Wash the fuel cap in a clean, nonflammable solvent and dry the fuel cap.
4. Put a light coating of fuel on the cap gasket.
5. Install the fuel cap.

i01817381

Fuel Tank Water and Sediment - Drain

SMCS Code: 1273-543-M&S

Note: Drain the water and the sediment from the fuel tank when the tank is almost empty.

1. Slowly remove the fuel tank cap in order to relieve the tank pressure.

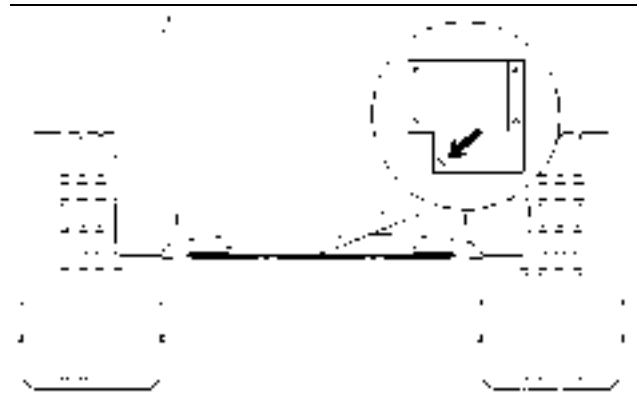

Illustration 139

g00928088

location of the drain plug for the 267, 277 and 287

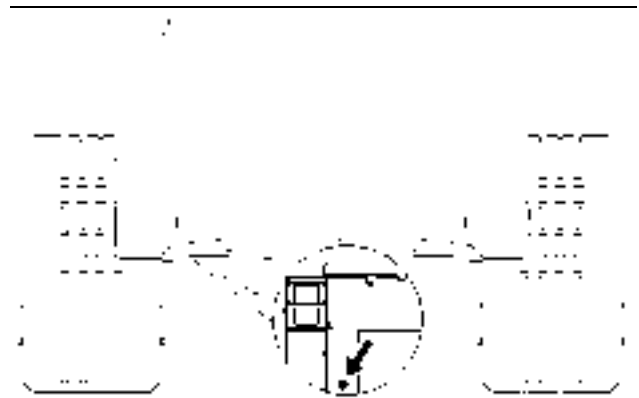

Illustration 140

g00928025

location of the drain plug for the 247 and the 257

2. The fuel tank drain plug for the 267, 277 and 287 machines is located on the side of the tank. Remove the access panel in the bottom of the machine in order to access the drain plug. Loosen the drain plug. The fuel tank drain plug for the 247 and 257 machines is located underneath the machine at the left rear corner. Loosen the plug.
 3. Allow the water and the sediment to drain into a suitable container.
 4. Install the fuel tank drain plug.
- Note:** Apply 5P-3413 Pipe Sealant to the threads on the drain plug.
5. Install the fuel tank cap.

i01850570

Hydraulic Oil Sample - Obtain

SMCS Code: 5050-008; 7542-008

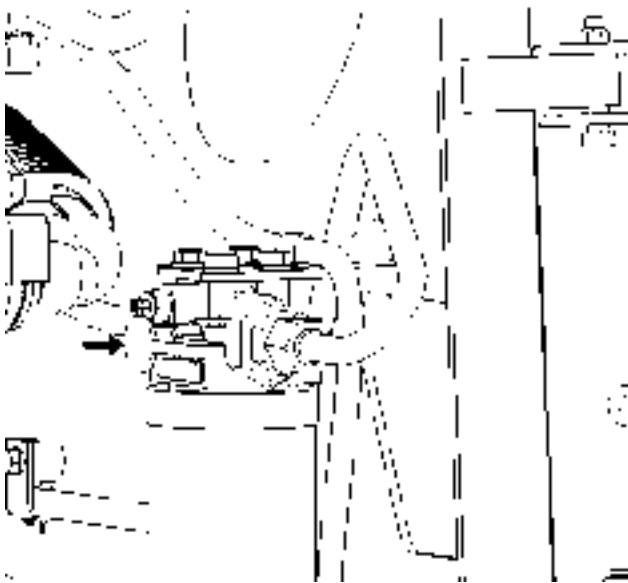

Illustration 141

g00942655

The sampling port for the hydraulic fluid is located on the hydraulic oil filter base.

i01817182

Hydraulic System Oil - Change

SMCS Code: 5095-044

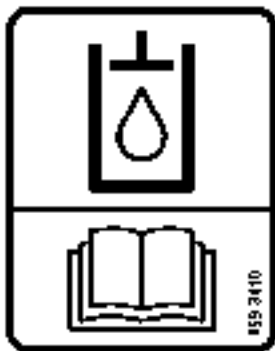

Illustration 142

g00956818

Note: This film is located near the hydraulic filler cap on machines that are filled with synthetic oil.

Operate the machine for a few minutes in order to warm the hydraulic system oil.

WARNING

Personal injury or death can result without releasing all of the hydraulic pressure.

Release all the pressure from the hydraulic system before any lines are disconnected.

The machine should be on level ground. Lower the bucket to the ground and apply slight downward pressure. Engage the parking brake and stop the engine. Keep the armrest lowered. Turn the engine start switch key to the ON position. Push the parking brake switch. Move all of the hydraulic control levers while you press several times on each side of the auxiliary hydraulic control (if equipped) in order to relieve hydraulic pressure. Move the engine start switch key to the OFF position.



Illustration 143

g00926534

1. Remove the hydraulic tank filler cap.

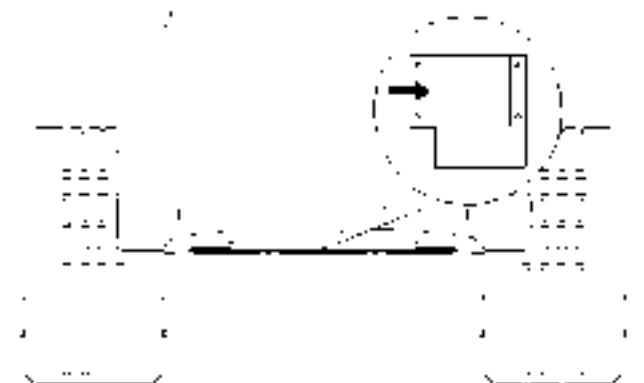

Illustration 144

g00954934

2. Remove the access panel in the belly guard underneath the machine.

i01786743

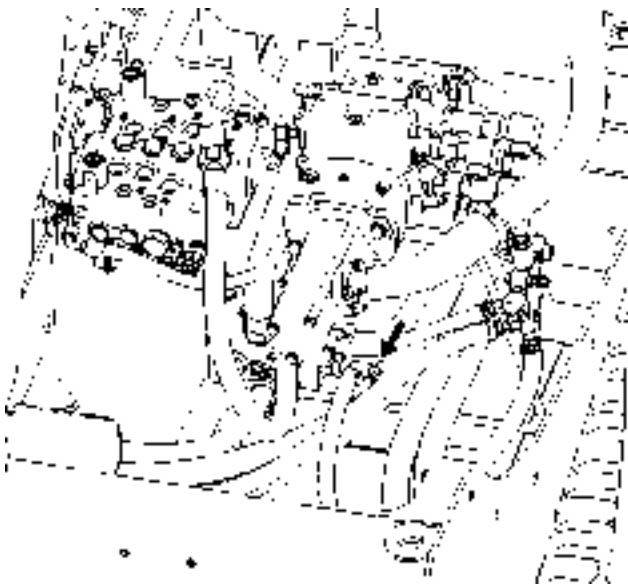

Illustration 145

g00927954

3. Remove the plug from the end of the drain hose. Pull the drain hose through the access panel in the belly guard. Open the drain valve and drain the oil into a suitable container.
4. Close the drain valve and pull the drain hose back into the machine. Install the drain plug into the drain hose.
5. Change the hydraulic system filter. Refer to Operation and Maintenance Manual, "Hydraulic System Oil Filter - Change".
6. Fill the hydraulic system oil tank. Refer to Operation and Maintenance Manual, "Lubricant Viscosities" and Operation and Maintenance Manual, "Capacities (Refill)".
7. Maintain the hydraulic oil level approximately in the middle of the sight gauge.

Check the oil level with the loader arms in the fully lowered position.

Note: The oil must be free of bubbles. If bubbles are present in the oil, air is entering the hydraulic system. Inspect the suction hoses and hose clamps.

8. Install the hydraulic tank filler cap.

Hydraulic System Oil Filter - Replace

SMCS Code: 5068-510

The hydraulic oil filter is located in the engine compartment.

1. Open the engine access door. Refer to Operation and Maintenance Manual, "Access Doors and Covers".



Illustration 146

g00926534

2. Remove the hydraulic tank filler cap.

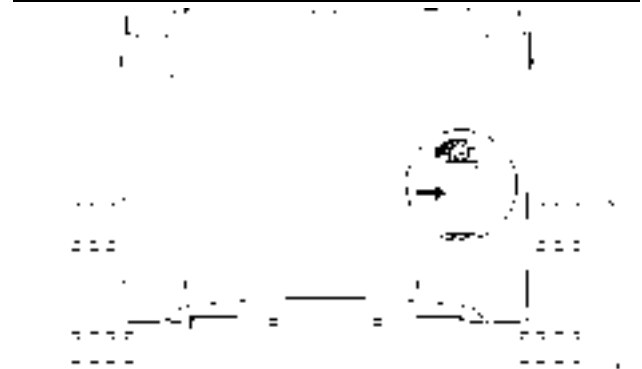

Illustration 147

g00926537

3. Remove the filter with a strap type wrench.

Note: Place a suitable nonconductive container under the hydraulic oil filter. Use this container in order to catch any oil that may spill from the filter or the filter element mounting base.

4. Clean the filter element mounting base. Remove any part of the filter element gasket that remains on the filter element mounting base.
5. Apply a light coat of oil to the gasket of the new filter element gasket.

6. Install the new filter element by hand. When the gasket contacts the filter element mounting base, tighten the filter element for an additional three quarters of a turn.
7. Maintain the hydraulic oil level to the middle of the sight gauge. Refer to Operation and Maintenance Manual, "Hydraulic System Oil Level - Check". **Do not overfill the hydraulic tank.**
8. Inspect the gasket on the hydraulic tank filler cap for damage. Replace the hydraulic tank filler cap, if necessary. Install the hydraulic tank filler cap.
9. Close the engine access door.

i01786416

Hydraulic System Oil Level - Check

SMCS Code: 5095-535-FLV

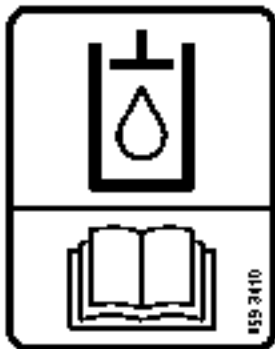

Illustration 148

g00956818

Note: This film is located near the hydraulic filler cap on machines that are filled with synthetic oil.



Illustration 149

g00926168

sight gauge (type 1)

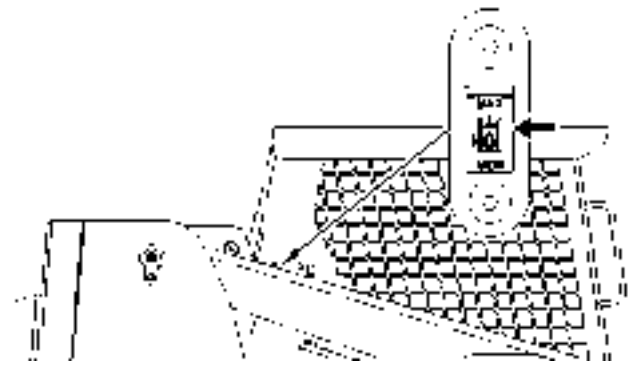

Illustration 150

g00926177

sight gauge (type 2)

1. Park the machine on level ground.
2. Lower the work tool to the ground. Turn off the engine.
3. Wait for about five minutes before checking the level of the hydraulic oil.
4. Maintain the oil level to the middle of the sight gauge. **Do not overfill the hydraulic tank.**

i01871469

Lift Arm and Cylinder Linkage - Lubricate

SMCS Code: 5102-086-BD; 6107-086-BD

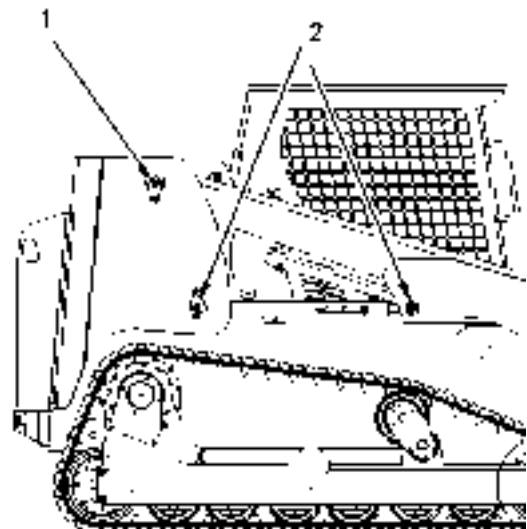

Illustration 151

g00953049

247, 267 and 277 machines

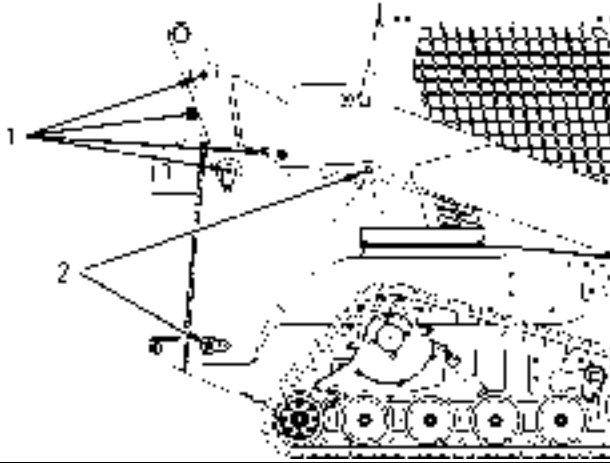

Illustration 152
257 and 287 machines

g00953053

Apply lubricant to the grease fittings (1) for the lift arm linkage.

Apply lubricant to the grease fittings (2) for the lift cylinder bearings.

Repeat the process for the opposite side of the machine.

i01877982

Lower Machine Frame - Clean

SMCS Code: 7050-070

1. Tilt the cab upward. Refer to Operation and Maintenance Manual, "Cab Tilting".

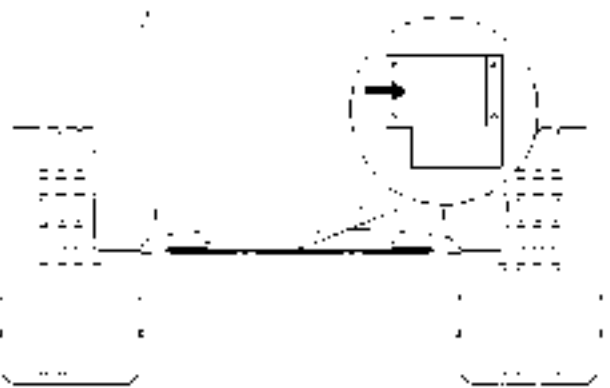

Illustration 153

g00954934

2. Remove the access panel in the frame that is located underneath the machine.

3. Remove any debris or dirt from the inside of the frame.
4. Reinstall the access panel and tilt the cab downward.

i02106227

Oil Filter - Inspect

SMCS Code: 1308-507; 3067-507; 5068-507

Inspect a Used Filter for Debris

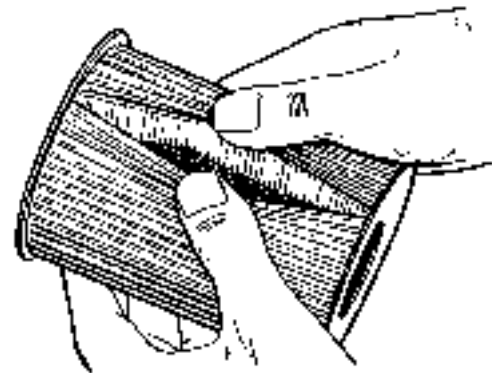

Illustration 154

g00100013

The element is shown with debris.

Use a filter cutter to cut the filter element open. Spread apart the pleats and inspect the element for metal and for other debris. An excessive amount of debris in the filter element can indicate a possible failure.

If metals are found in the filter element, a magnet can be used to differentiate between ferrous metals and nonferrous metals.

Ferrous metals can indicate wear on steel parts and on cast iron parts.

Nonferrous metals can indicate wear on the aluminum parts of the engine such as main bearings, rod bearings, or turbocharger bearings.

Small amounts of debris may be found in the filter element. This could be caused by friction and by normal wear. Consult your Caterpillar dealer in order to arrange for further analysis if an excessive amount of debris is found.

Using an oil filter element that is not recommended by Caterpillar can result in severe engine damage to engine bearings, to the crankshaft, and to other parts. This can result in larger particles in unfiltered oil. The particles could enter the lubricating system and the particles could cause damage.

i01734746

i01488851

Quick Coupler - Inspect

SMCS Code: 6129-040

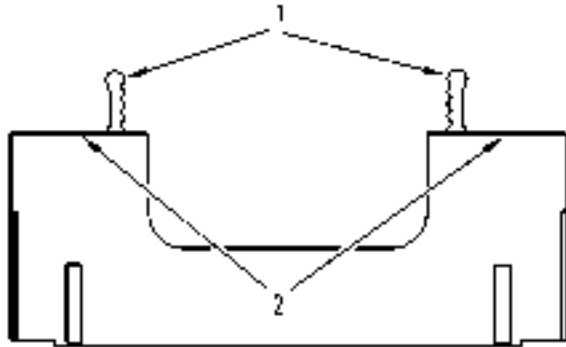

Illustration 155

g00889446

1. Move the quick coupler levers (1) to the disengaged position. Ensure that the levers are not bent or broken.
2. Check the top edges of the quick coupler assembly (2) for wear or for damage.

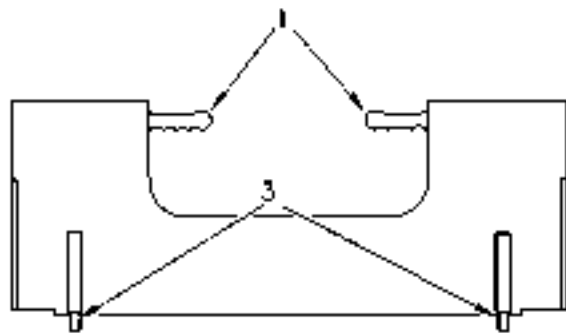

Illustration 156

g00889412

3. Move the quick coupler levers (1) to the engaged position. Ensure that the levers move freely without restriction.
4. Make sure that the coupler pins (3) extend through the bottom of the quick coupler assembly. Check the pins for wear and check the pins for damage.
5. Move the quick coupler levers to the disengaged position.

If any wear is suspected or damage is suspected, consult your Caterpillar dealer before you use a work tool.

Radiator Core - Clean

SMCS Code: 1353-070-KO

The radiator is located at the rear of the machine above the engine compartment.

1. Open the engine access door. Refer to Operation and Maintenance Manual, "Access Doors and Covers".
2. Tilt the radiator guard upward. Refer to Operation and Maintenance Manual, "Radiator Tilting".

NOTICE

When you are using compressed air or high pressure water to clean the radiator fins, ensure that the air or water is directed parallel to the fins. If the compressed air or high pressure water is not directed parallel to the radiator fins, the radiator fins could be bent or damaged.

Note: You can use compressed air, high pressure water, or steam to remove dust and other debris from the radiator fins. However, the use of compressed air is preferred.

3. Clean the radiator core.

NOTICE

Do not clean a running fan with high pressure water. Fan blade failure can result.

4. Remove any dirt or debris from the fan, the fan hub, the oil cooler, the radiator guard and the fan guard.

Note: Dirt or debris on the cooling fan can cause an imbalance.

5. Tilt the radiator guard downward.
6. Close the engine access door.

i01968724

i01968864

Refrigerant Dryer - Replace (If Equipped)

SMCS Code: 7322-510

WARNING

Personal injury can result from contact with refrigerant.

Contact with refrigerant can cause frost bite. Keep face and hands away to help prevent injury.

Protective goggles must always be worn when refrigerant lines are opened, even if the gauges indicate the system is empty of refrigerant.

Always use precaution when a fitting is removed. Slowly loosen the fitting. If the system is still under pressure, release it slowly in a well ventilated area.

Personal injury or death can result from inhaling refrigerant through a lit cigarette.

Inhaling air conditioner refrigerant gas through a lit cigarette or other smoking method or inhaling fumes released from a flame contacting air conditioner refrigerant gas, can cause bodily harm or death.

Do not smoke when servicing air conditioners or wherever refrigerant gas may be present.

Use a certified recovery and recycling cart to properly remove the refrigerant from the air conditioning system.

NOTICE

If the refrigerant system has been open to the outside air (without being plugged) for more than 30 minutes, the receiver-dryer must be replaced. Moisture will enter an open refrigerant system and cause corrosion which will lead to component failure.

Refer to Service Manual, SENR5664, "Air Conditioning and Heating R-134a For All Caterpillar Machines" for the proper procedure to change the receiver-dryer assembly and for the procedure to reclaim the refrigerant gas.

Note: The receiver-dryer must also be replaced when the air conditioning system is evacuated.

Rollover Protective Structure (ROPS) and Falling Object Protective Structure (FOPS) - Inspect

SMCS Code: 7323-040; 7325-040

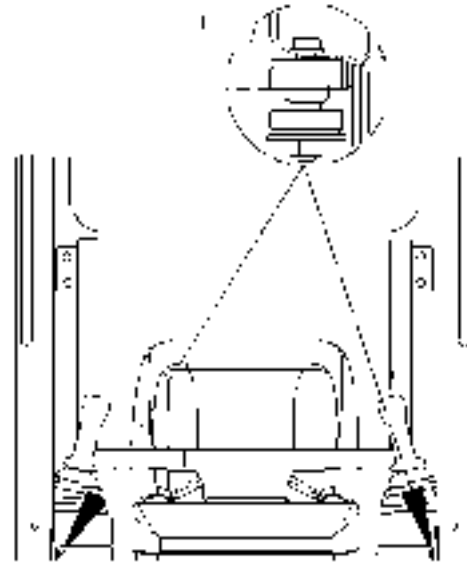

Illustration 157

g01022156

(1) Front ROPS retaining bolt (one bolt per side)

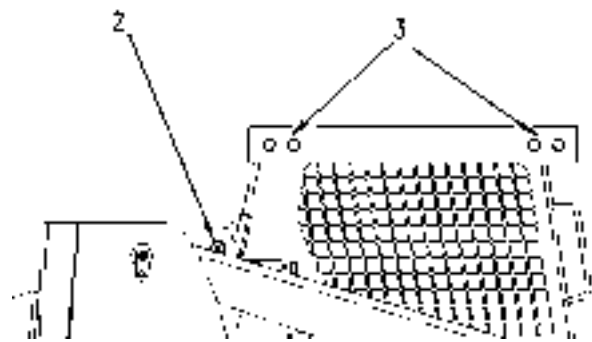

Illustration 158

g00925477

(2) Rear ROPS retaining bolt (one bolt per side)

(3) Retaining bolts for the FOPS 2

Note: There is a total of four retaining bolts for the ROPS. There is a total of eight retaining bolts for the FOPS 2.

1. Inspect the ROPS and the FOPS for loose bolts. Tighten the bolts (1) to the following torque 125 ± 10 N·m (92 ± 7 lb ft). Tighten the bolts (2) to the following torque 55 ± 5 N·m (41 ± 4 lb ft). Tighten the bolts (3) to the following torque 240 ± 40 N·m (177 ± 30 lb ft). ROPS and the FOPS for damaged bolts or missing bolts. Replace any damaged bolts or missing bolts with original equipment parts only.
2. Operate the machine on a rough surface. Replace the ROPS mounting supports if the ROPS emits a noise. Replace the ROPS mounting supports if the ROPS rattles.

Do not straighten the ROPS or the FOPS. Do not repair the ROPS or the FOPS by welding reinforcement plates to the ROPS or the FOPS.

Consult your Caterpillar dealer for repair of any cracks in the ROPS or the FOPS.

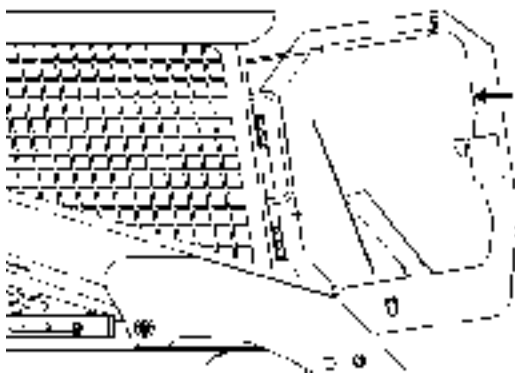

Illustration 159

g01022169

Inspect the Flying Object Guard (if equipped) for damage.

Consult your Caterpillar dealer for repair of any cracks in the Flying Object Guard.

i02429589

Seat Belt - Inspect

SMCS Code: 7327-040

Always check the condition of the seat belt and the condition of the seat belt mounting hardware before you operate the machine. Replace any parts that are damaged or worn before you operate the machine.

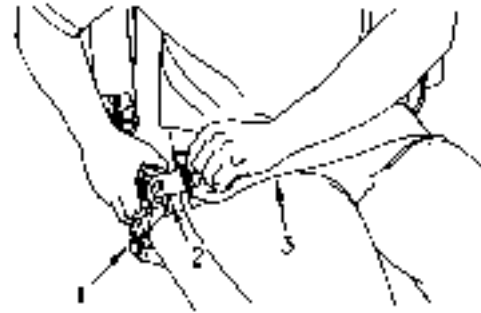

Illustration 160

g00932801

Typical example

Check the seat belt mounting hardware (1) for wear or for damage. Replace any mounting hardware that is worn or damaged. Make sure that the mounting bolts are tight.

Check buckle (2) for wear or for damage. If the buckle is worn or damaged, replace the seat belt.

Inspect the seat belt (3) for webbing that is worn or frayed. Replace the seat belt if the seat belt is worn or frayed.

Consult your Caterpillar dealer for the replacement of the seat belt and the mounting hardware.

Note: Within three years of the date of installation or within five years of the date of manufacture, replace the seat belt. Replace the seat belt at the date which occurs first. A date label for determining the age of the seat belt is attached to the seat belt, the seat belt buckle, and the seat belt retractor.

If your machine is equipped with a seat belt extension, also perform this inspection procedure for the seat belt extension.

i02429594

Seat Belt - Replace

SMCS Code: 7327-510

Within three years of the date of installation or within five years of the date of manufacture, replace the seat belt. Replace the seat belt at the date which occurs first. A date label for determining the age of the seat belt is attached to the seat belt, the seat belt buckle, and the seat belt retractor.

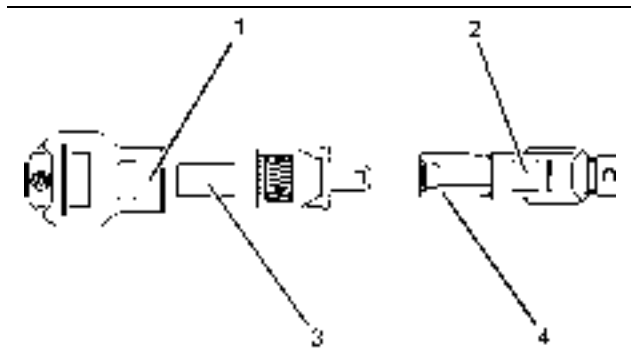

Illustration 161 g01152685

- (1) Date of installation (retractor)
- (2) Date of installation (buckle)
- (3) Date of manufacture (tag) (fully extended web)
- (4) Date of manufacture (underside) (buckle)

Consult your Caterpillar dealer for the replacement of the seat belt and the mounting hardware.

If your machine is equipped with a seat belt extension, also perform this replacement procedure for the seat belt extension.

i02110179

Sprocket - Inspect

SMCS Code: 4164-040

Note: Operating the machine in conditions that are extremely muddy or sandy will cause accelerated wear on the drive sprocket and other undercarriage components. It is important to clean the undercarriage of the machine daily in order to maximize component life.

In order to service the drive sprocket, the tracks must be removed. Refer to Operation and Maintenance Manual, "Track (Rubber) - Remove/Install".

Sleeves

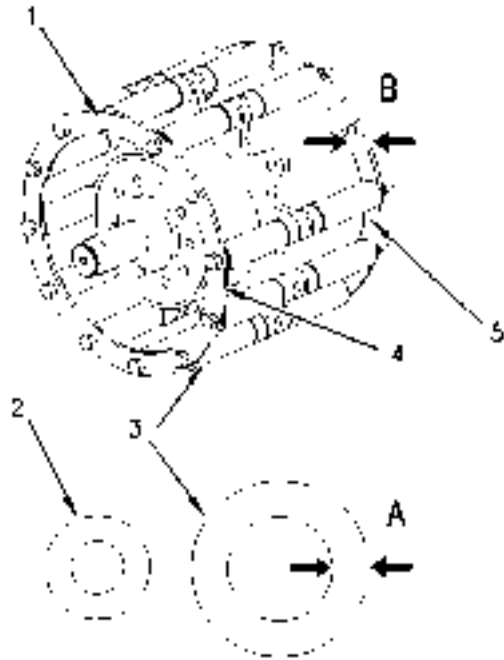

Illustration 162 g00801623

The drive sprocket is equipped with two types of sleeves. The inner sleeves (2) are held in position by the rings of the sprocket (4) and (5). The outer sleeves (3) are free to rotate on the inner sleeves.

Measure thickness (A) for the outer sleeves. If the thickness of the outer sleeves measures less than the minimum thickness that is listed in the following table replace the sleeves.

Note: When you replace the outer sleeves, rotate the inner sleeves for 180°. If the inner sleeves have already been rotated, replace the inner sleeves.

Table 21

247, 257, 267, 277, and 287	
Component	Minimum Thickness
Outer Sleeve	3 mm (0.12 inch)

Rings

The inner rings (5) and the outer rings (4) of the drive sprocket will wear from the rotation of the outer sleeves. Measure the thickness (B) of the inner rings and outer rings. If the thickness of the inner ring or outer ring measures less than the minimum thickness that is listed in the following table replace the ring.

Table 22

247, 257, 267, 277, and 287	
Component	Minimum Thickness
Sprocket Rings	4.75 mm (0.19 inch)

i01992415

Sprocket Bearings - Lubricate

SMCS Code: 4164-086-BD; 7551-086-JK

NOTICE

The service interval for the lubrication of the sprocket bearings should be reduced to every 500 service hours if the machine is operated in wet and muddy conditions.

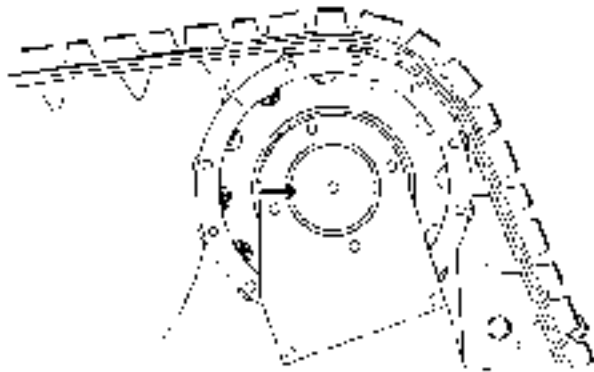

Illustration 163
typical example

g01025225

1. Use a mallet in order to pound the housing plug inward until the plug falls out of the housing. If the plug was damaged during removal, replace the plug.
2. Wipe the old grease out of the housing.
3. Pull out the bearing seal. Replace the seal if the seal is damaged.
4. Pack the bearing with clean grease and push the seal into position. Place clean grease on the outside of the seal in order to protect the seal.
5. If the old housing plug is reinstalled, reverse the housing plug and pound the plug into the housing.

i02125302

Sprocket Retaining Nuts - Check

SMCS Code: 4164-535-NT

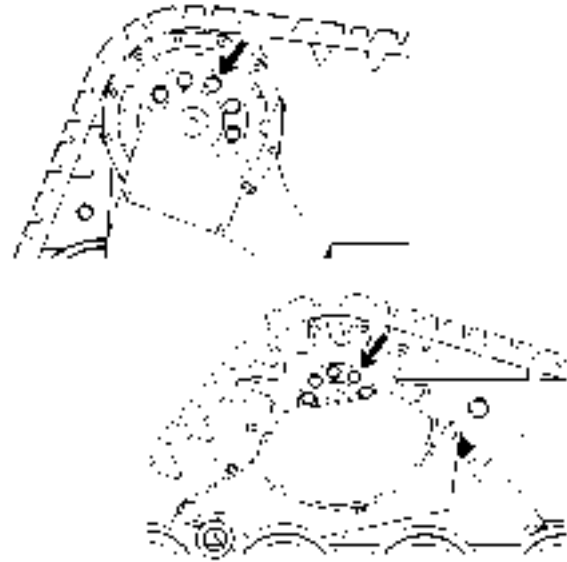

Illustration 164

g00953040

Check the torque on the nuts for new sprockets or for sprockets that have been reinstalled after every ten service hours until the specified torque is maintained.

Check the nuts on both sprockets. Use a star pattern when you tighten the nuts.

Tighten the nuts for the 247 and 257 to the following torque 175 ± 30 N·m (129 ± 22 lb ft).

Tighten the nuts for the 267, 277 and 287 to the following torque 270 ± 40 N·m (199 ± 30 lb ft).

i01878236

Tilt Cylinder Bearings and Bucket Linkage Bearings - Lubricate

SMCS Code: 5104-086-BD; 6107-086-BD

Wipe all of the grease fittings before you apply lubricant.

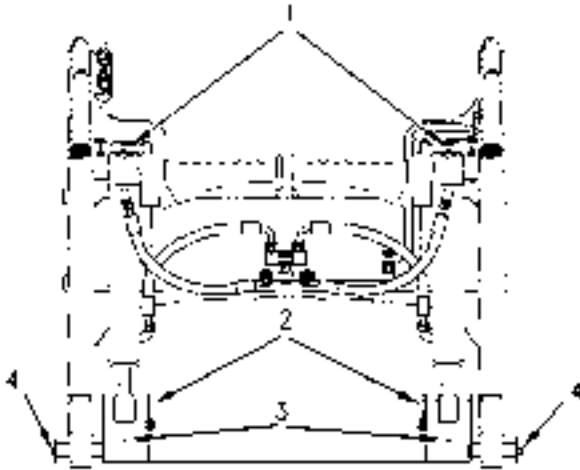

Illustration 165

g00955895

Note: Lubricate the fittings with the loader lift arms in the fully lowered position.

Apply lubricant to the grease fittings (1) for the upper bearings for the tilt cylinders.

Apply lubricant to the grease fittings (2) for the lower bearings for the tilt cylinders.

Apply lubricant to the grease fittings (3) for the coupler engagement pins.

Apply lubricant to the grease fitting (4) for the pivot pin of the quick coupler assembly.

There are a total of 8 grease fittings.

i02303875

Track (Rubber) - Inspect/Adjust

SMCS Code: 4197; 4198-025; 4198-040

Periodic adjustment of the track tension is necessary in order to avoid damage to the tracks. If a track is too loose, the track will be more likely to come off of the machine.

Track guides are recommended if the machine will be operated in very rough terrain. Track guides are recommended for the 267 and 277 if the machine will be frequently operated on side slopes or very rough terrain.

NOTICE

Do not overtighten the tracks. Tracks that are too tight can cause premature failure of the tracks. Tracks that are too tight can cause power loss and bearing failures.

Track Adjustment for the 247 and 257

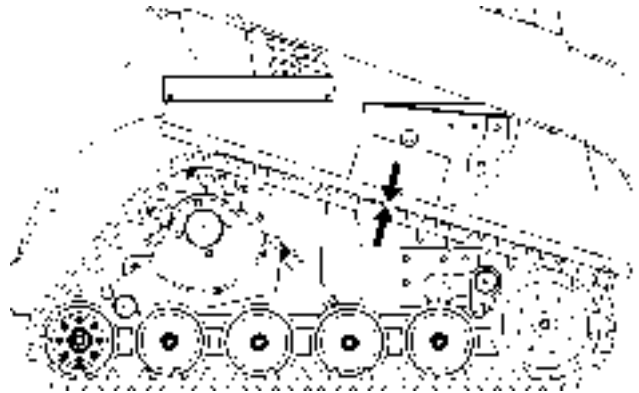

Illustration 166

g00903060

1. Place a 45 kg (100 lb) weight between the drive sprocket and the idlers. Place a straight edge across the drive sprocket and idlers. Measure the track sag between the bottom of the straight edge and the top of the track. **The track sag should be set at 12 mm (0.5 inch).** If the track needs adjustment proceed with the following steps.

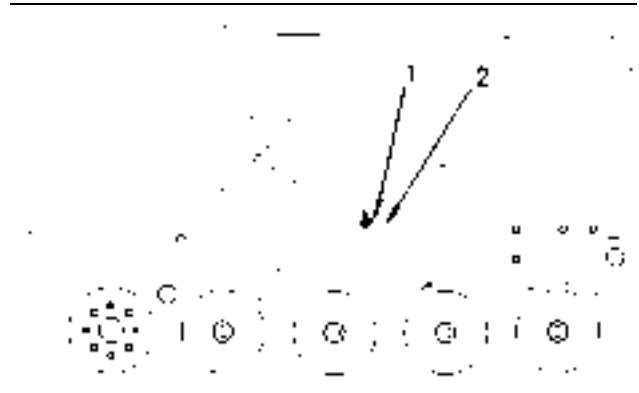

Illustration 167

g00899237

2. Loosen the jam nut (1).
3. Turn the adjuster (2) in order to raise or lower the drive sprocket.

Note: In order to detension the track for removal, fully lower the drive sprocket.

4. Tighten the jam nut to the following torque
270 ± 40 N·m (199 ± 30 lb ft).

5. Recheck the track tension.

Track Adjustment for the 267 and 277

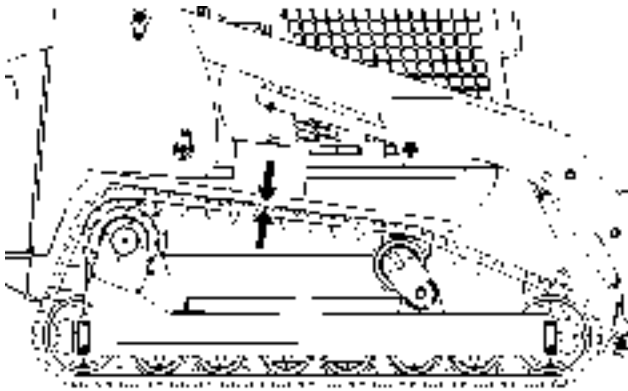

Illustration 168

g00900571

1. Place a 45 kg (100 lb) weight between the drive sprocket and the idlers. Place a straight edge across the drive sprocket and idlers. Measure the track sag between the bottom of the straight edge and the top of the track. **The track sag should be set at 12 mm (0.5 inch).** If the track needs adjustment proceed with the following steps.

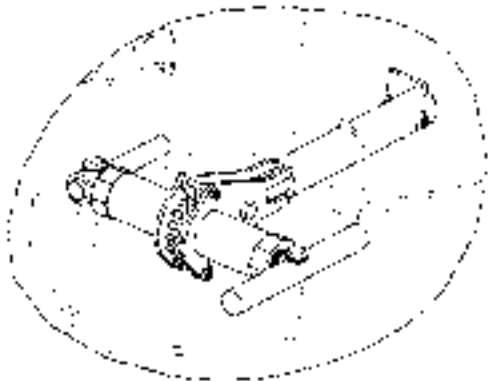

Illustration 169

g00899624

2. Remove the tool that is provided for tensioning the track. The tool is stored on the left side of the engine compartment.

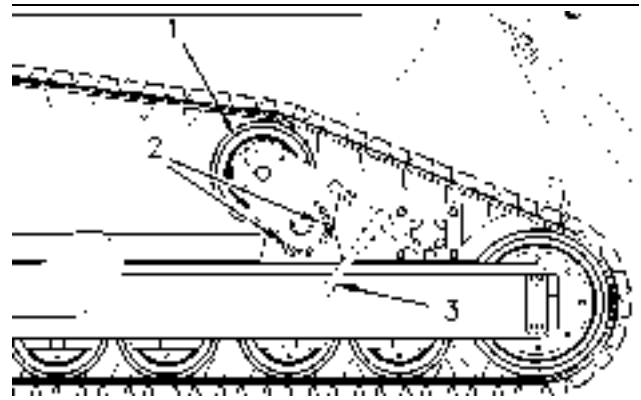

Illustration 170

g00899250

3. Install the tool (3). Ratchet the tool in order to remove any pressure that is being placed on the bolts (2). Remove the two bolts, lockwashers and locknuts (2). Ratchet the tool in order to pivot the idlers (1).
4. Pivot the idlers forward until you are able to reinstall the two bolts in the next available holes. Reinstall the two bolts, lockwashers and locknuts. Tighten the two bolts to the following torque 120 N·m (89 lb ft). Remove the tool.

Note: In order to detension the track for removal, pivot the idlers backward.

Note: If the idler is already in a vertical position it may be necessary to relocate the mounting bolts for the drive frame into the second set of holes that is provided in order to achieve the proper track tension. Refer to Operation and Maintenance Manual, "Adjustment of the Drive Frame for the 267 and 277" for the correct procedure.

5. Recheck the tension of the track.

Adjustment of the Drive Frame for the 267 and 277

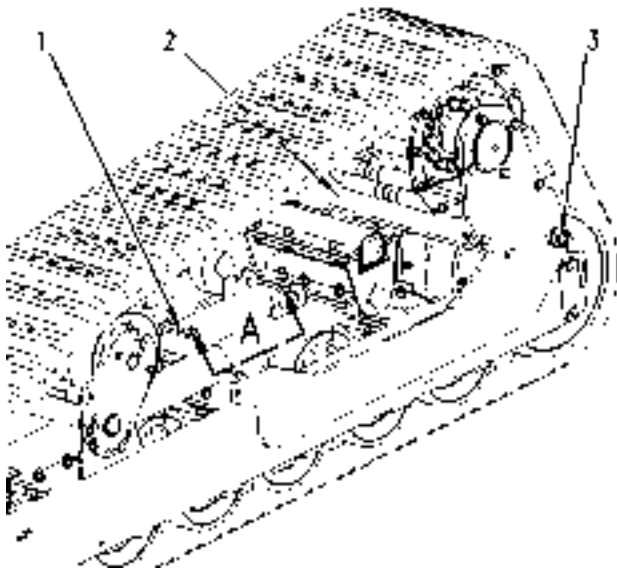

Illustration 171

g00900564

1. Fully lower the wheels that tension the track so that all tension is removed from the track. Remove the bolts (1), (2) and (3) that secure the drive frame.

Note: The bolt (2) is located on the opposite side of the drive frame from bolt (3). It will be necessary to raise the body of the machine in order to gain access to this bolt.

2. Install the tool into the brackets (A). Position the tool so that the fixed end of the tool is positioned inside the hooks. Slide the pin that is located on the other end of the tool through the holes in the undercarriage in order to secure the tool. Ratchet the tool in order to move the drive frame backward. Continue to move the drive frame until the second set of mounting holes are visible and the three bolts can be reinstalled. Tighten the bolts. Adjust the track tension.

Note: A pry bar may be needed in order to lift the drive frame upward when you move the drive frame rearward.

Note: Ensure that the drive lugs of the track do not contact the front axle.

Track Adjustment for the 287

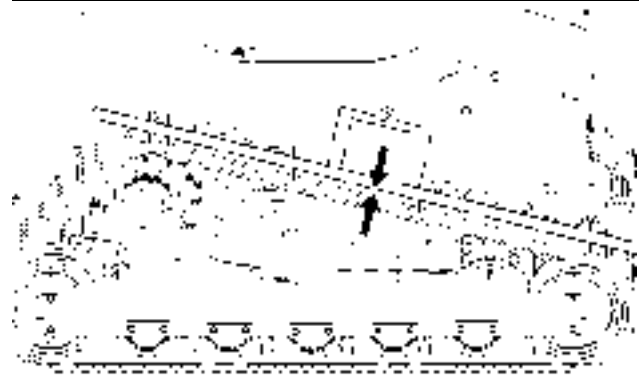

Illustration 172

g00954633

1. Place a 45 kg (100 lb) weight between the drive sprocket and the idlers. Place a straight edge across the drive sprocket and idlers. Measure the track sag between the bottom of the straight edge and the top of the track. **The track sag should be set at 12 mm (0.5 inch).** If the track needs adjustment proceed with the following steps.

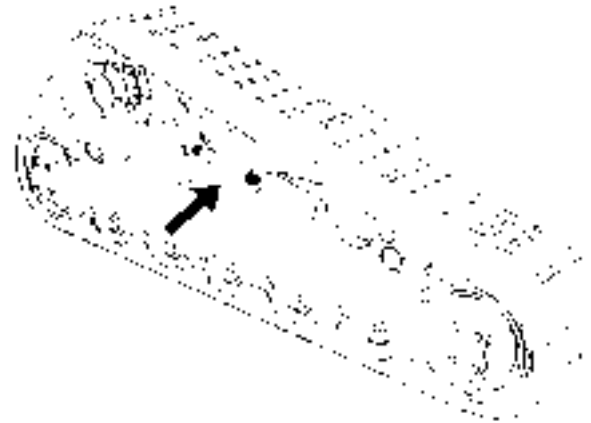

Illustration 173

g01011089

2. Install the track tensioner. The square portion of the bracket assembly for the track tensioner fits into the square cutouts on top of the undercarriage.

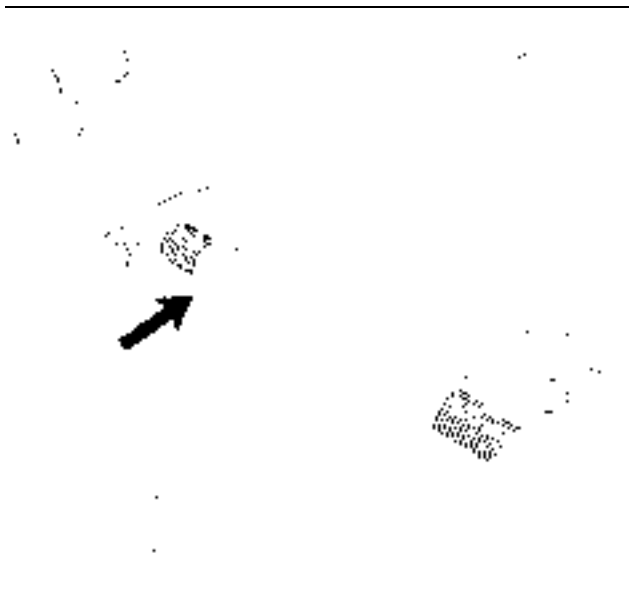

Illustration 174

g01011091

3. Loosen the jam nut and turn the adjuster in order to align the bore of the track tensioner with the holes in the mounting brackets on the drive frame.
4. Install the retaining pin through the holes and install the lock pin in order to secure the retaining pin.
5. Keep the jam nut loosened and turn the adjuster in order to tighten the turnbuckle. The track tensioner should be tight enough to hold the weight of the drive frame.

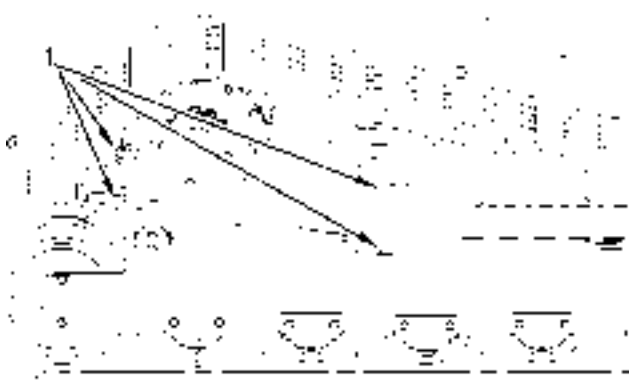

Illustration 175

g00954340

6. Remove the four retaining bolts (1).
7. Turn the adjuster in order to move the drive frame rearward. Turn the adjuster until the four bolts can be loosely installed into the next set of mounting holes.
8. Recheck the tension per Step 1.

If the sag that is measured is 12 mm (0.5 inch), install the four retaining bolts (1). Tighten the bolts to a torque of 215 ± 40 N·m (159 ± 30 lb ft).

If the sag that is measured is NOT 12 mm (0.5 inch), repeat Step 5 through Step 8.

9. Turn the adjuster slightly in order to relieve tension.

Note: Maintain a tension that is sufficient for retaining the track tensioner in the stored position on the undercarriage.

10. Tighten the jam nut to a torque of 270 ± 40 N·m (199 ± 30 lb ft).

Additional Adjustment for the 287

In certain situations, the tracks for the machine are in usable condition but the normal adjustment procedure will not tension the track to the recommended specification. By reversing the position of the 234-0789 Brackets, additional track tension can be achieved. This is possible because the slot for the brackets is offset. Reversing the brackets will increase the distance between the idler wheels, which results in additional tension on the track. See Illustration 176.

Note: In order to access the brackets, refer to the procedure for removing the idler wheels in the Operation and Maintenance Manual, "Bogie and Idler - Inspect/Replace".

Reversing the four 234-0789 Brackets will increase the distance between the idler wheels by 12 mm (0.47 inch). After you reverse the brackets and after you reassemble the components for the undercarriage frame, check for proper track tension. Refer to the procedure "Track Adjustment for the 287".

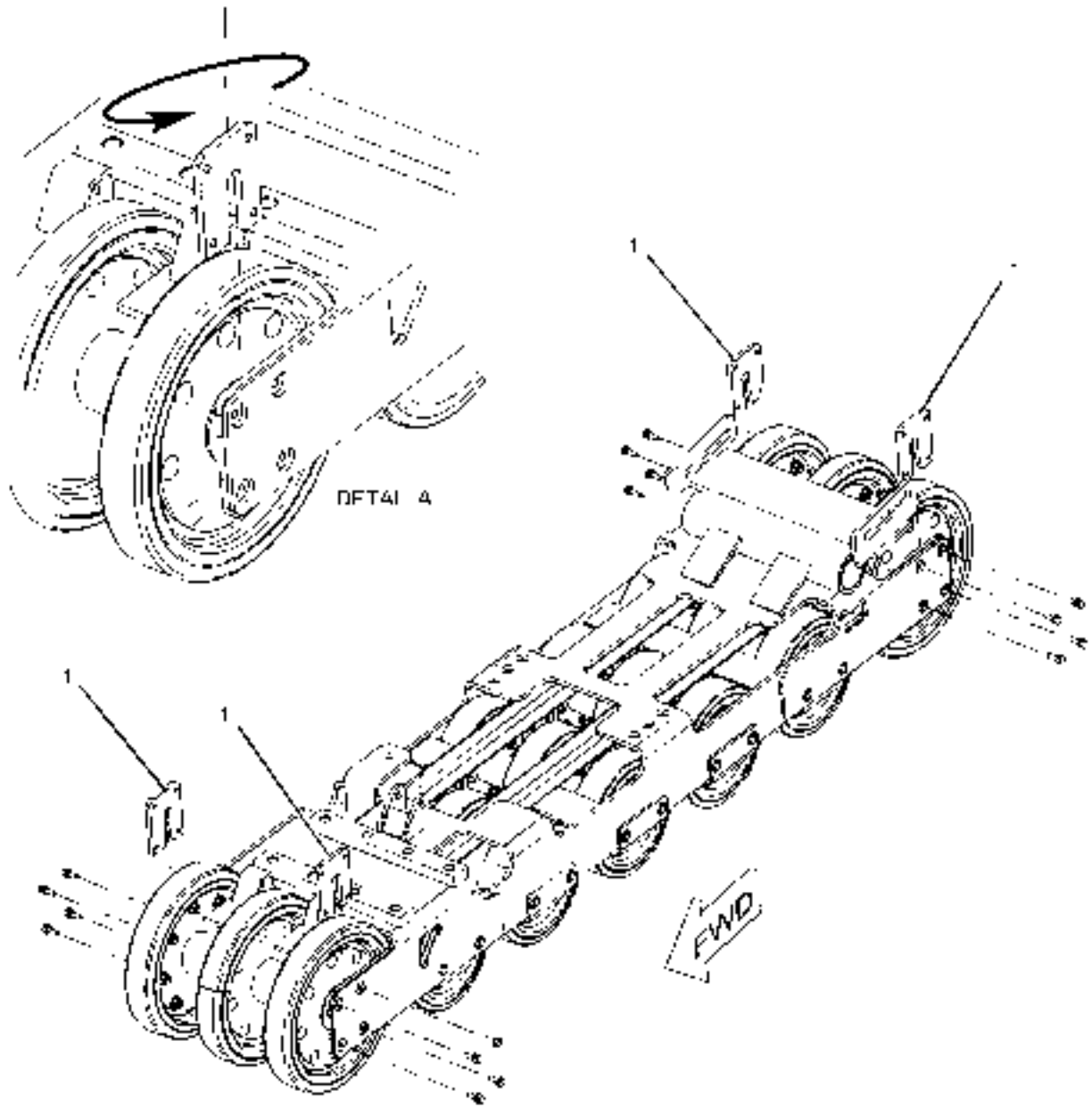

Illustration 176
Reverse the four brackets (1) by rotating each bracket by 180°. See Detail A.

i01947524

Track (Rubber) - Remove/Replace

SMCS Code: 4197; 4198-011; 4198-510

Removing the Track 247 and 257

Note: Refer to the table for the tooling that is needed in order to remove the tracks and install the tracks on the 247 and 257 machines.

Table 23

Required Tools	
Part Number	Part Description
224-9417	Cap
224-9416	Installation Tool (Wheel)
224-9415	Kit ⁽¹⁾

⁽¹⁾ The Kit includes the Cap and the Installation Tool.

1. Position the machine on firm, level ground.
2. Remove any work tool that is attached to the quick coupler.
3. Raise the loader arms and install the brace for the loader lift arm. Refer to Operation and Maintenance Manual, "Loader Lift Arm Brace Operation".
4. Use an appropriate floor jack in order to lift the machine off the ground. Use appropriate jack stands in order to block up the machine.
5. Detension the track. Refer to Operation and Maintenance Manual, "Track (Rubber) - Inspect/Adjust".

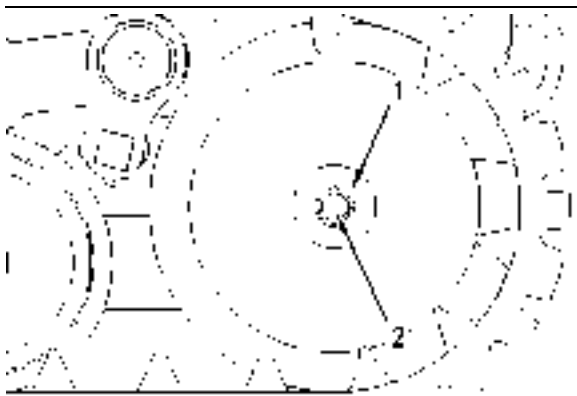

Illustration 177

g00953660

6. Remove the snap ring (1) and the dust cover (2).

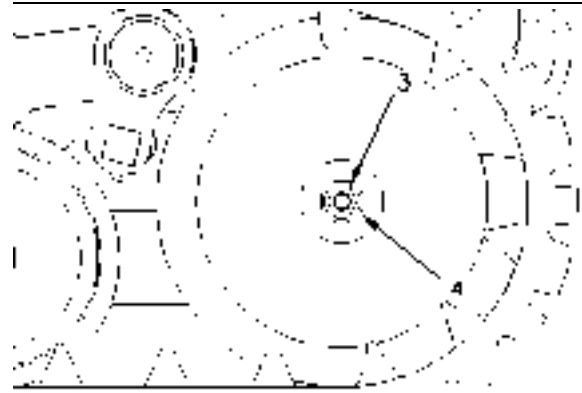

Illustration 178

g00953716

7. Remove the nut (3) and the washer (4).

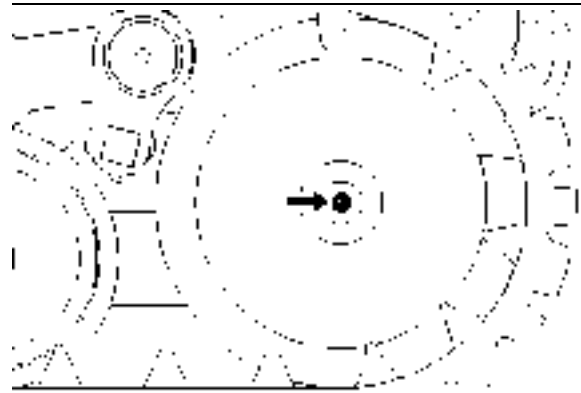

Illustration 179

g00953721

8. Thread the cap onto the end of the axle shaft.

Note: If the cap is not installed, the seal on the wheel will be damaged.

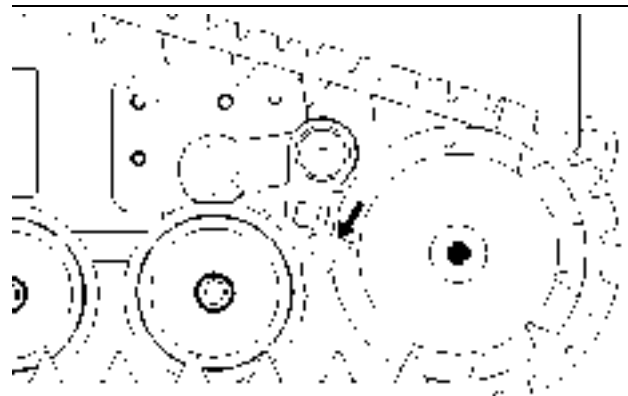

Illustration 180

g00953723

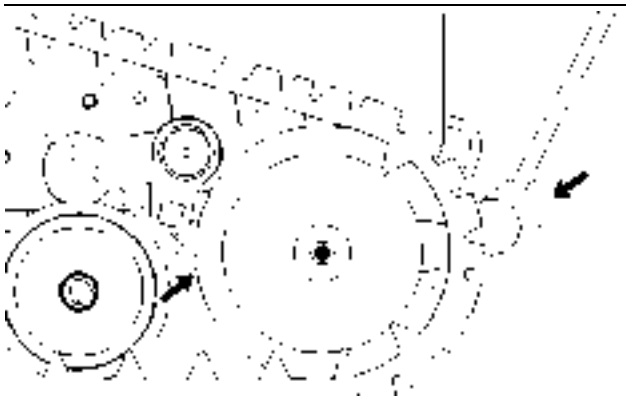

Illustration 181

g00953730

9. Use a large mallet in order to strike the inside of the track. This will cause the wheel bearing to pop out of the wheel. The bearing must come out of the wheel in order for the wheel to be removed. A pry bar may be needed in order to remove the wheel completely.

10. Remove the track.

Installing the Track 247 and 257

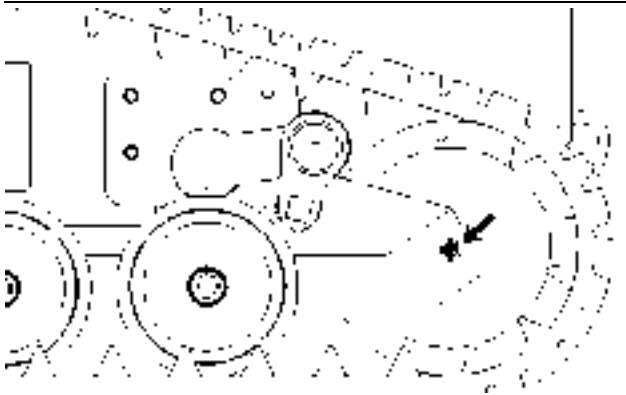

Illustration 182

g00953812

1. Install the cap.

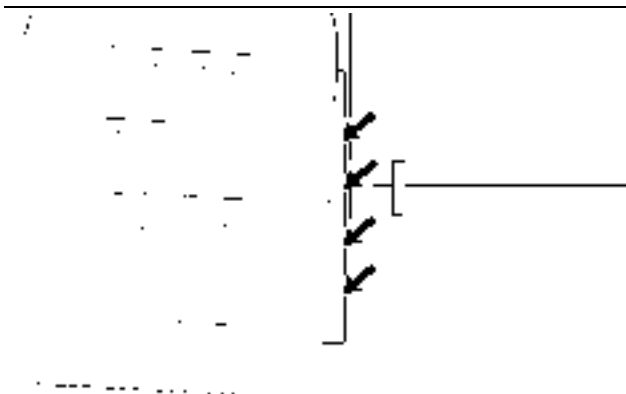

Illustration 183

g00953873

2. Lubricate the wheel and the inside of the track in order to ease the installation of the track. Pull the track onto the wheels.



Illustration 184

g00953919

3. Inspect the seal on the wheel. Replace the seal if the seal is damaged.

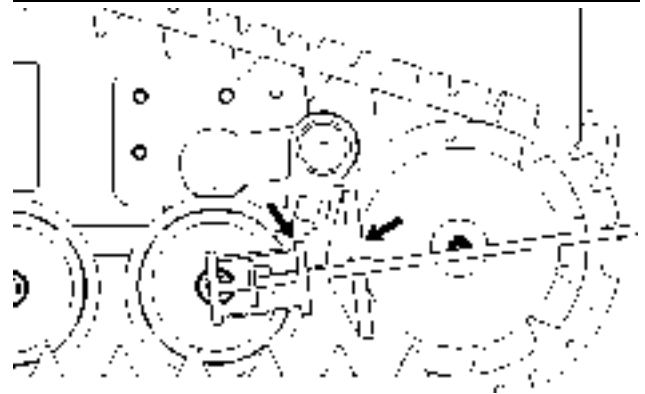

Illustration 185

g00953942

4. Use the installation tool for the track in order to install the wheel onto the shaft. Remove the cap.

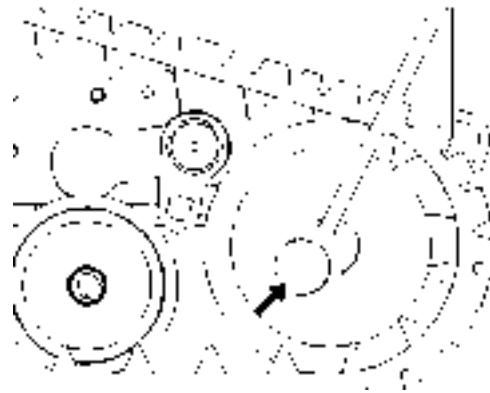

Illustration 186

g00954078

5. Use a mallet in order to seat the wheel on the shaft.

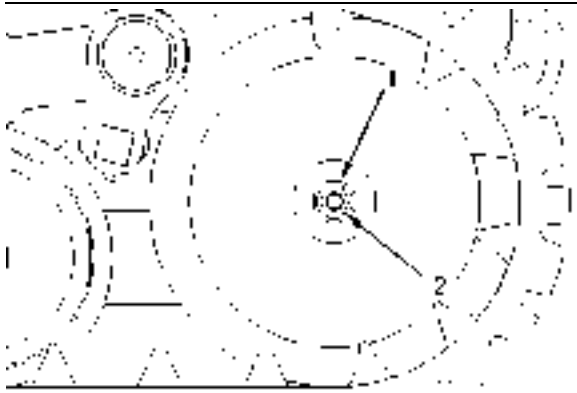

Illustration 187

g00954079

6. Install the washer (1) and the nut (2). Torque the nut to the following torque 168 ± 30 N·m (124 ± 22 lb ft).

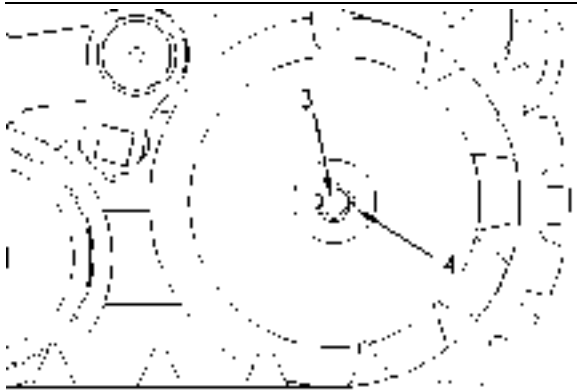

Illustration 188

g00954083

7. Install the dust cap (3) and the snap ring (4).
8. Tension the track. Refer to Operation and Maintenance Manual, "Track (Rubber) - Inspect/Adjust".

Removing the Track 267 and 277

1. Position the machine on firm, level ground.
2. Remove any work tool that is attached to the quick coupler. The quick coupler is mounted to the front of the loader arms.
3. Raise the loader arms and install the brace for the loader lift arm. Refer to Operation and Maintenance Manual, "Loader Lift Arm Brace Operation".
4. Detension the track. Refer to Operation and Maintenance Manual, "Track (Rubber) - Inspect/Adjust".

5. Use an appropriate floor jack to lift the machine so that the track is nearly off of the ground. Use appropriate jack stands in order to block up the machine.

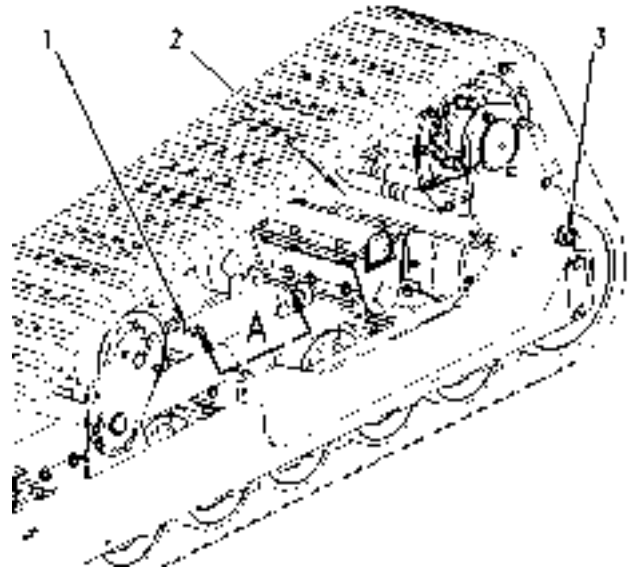

Illustration 189

g00954089

6. Remove the three bolts (1),(2) and (3) that secure the drive frame.

Note: The bolt (2) is located on the opposite side of the drive frame from bolt (3). It will be necessary to raise the body of the machine in order to gain access to this bolt.

Note: When you reinstall the three bolts, tighten bolts (2) and (3) to the following torque 120 ± 20 N·m (89 ± 15 lb ft). When you reinstall the bolt (1) tighten the bolt to the following torque 430 ± 60 N·m (317 ± 44 lb ft).

7. Install the track adjusting tool into the brackets (A). Ratchet the tool in order to slide the drive frame forward.

Note: When you reinstall the track you must slide the drive frame rearward into the original position. A pry bar may be needed in order to pry the drive frame upward when you slide the drive frame rearward.

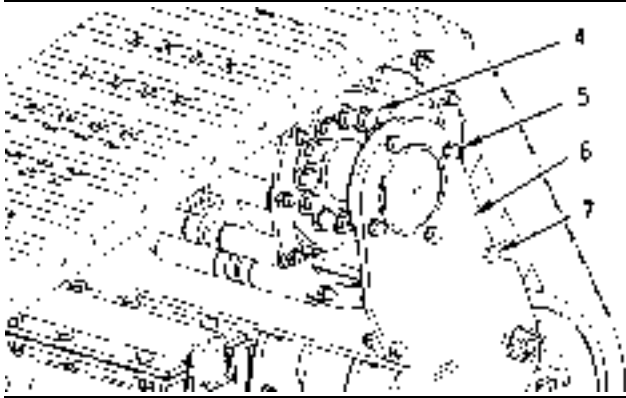

Illustration 190

g00954090

8. Remove the two bolts and the locknuts (7). Remove the four bolts and lockwashers (5). Remove the support plate for the drive sprocket (6).

Note: When you reinstall the bolts (6) tighten the bolts to the following torque 120 ± 20 N·m (89 ± 15 lb ft). When you reinstall the bolts (7) tighten the bolts to the following torque 105 ± 20 N·m (77 ± 15 lb ft).

9. Remove the twelve bolts (4) that retain the drive sprocket to the drive motor.

Note: When you reinstall the bolts (4) tighten the bolts to the following torque 270 ± 40 N·m (199 ± 30 lb ft).

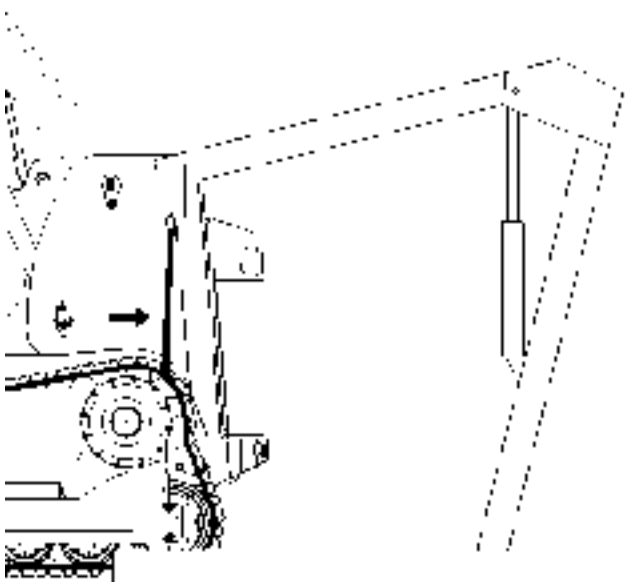

Illustration 191

g00954096

10. Use a lifting device that is suitable in order to lift the track. Lift the track in order to remove the drive sprocket. It may be necessary to insert a chock in front of the rear idler in order to prevent the track from spinning as you lift the track.

11. Remove the drive sprocket.
12. Remove the lifting device from the track. The lifting device is not required for removing the track from the machine.
13. Grasp the track on top of the drive sprocket. Pull the top of the track upward and pull the track to the outside. Slide the track past the bogies. Lift the track off the front idlers.

Installing the Track 267 and 277

1. Follow the steps in reverse order in order to replace the track.
2. Tighten the track to the proper tension. Refer to Operation and Maintenance Manual, "Track (Rubber) - Inspect/Adjust".

Removing the Track 287

1. Position the machine on firm, level ground.
2. Remove any work tool that is attached to the quick coupler.
3. Raise the loader arms and install the brace for the loader lift arm. Refer to Operation and Maintenance Manual, "Loader Lift Arm Brace Operation".
4. Use an appropriate floor jack in order to lift the machine off the ground. Use appropriate jack stands in order to block up the machine.
5. Detension the track. Refer to Operation and Maintenance Manual, "Track (Rubber) - Inspect/Adjust".

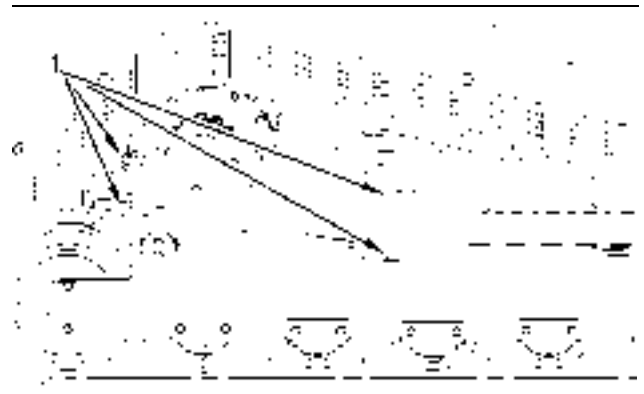

Illustration 192

g00954340

6. Remove the four bolts (1) that secure the drive frame. The two rear bolts are secured with nuts.

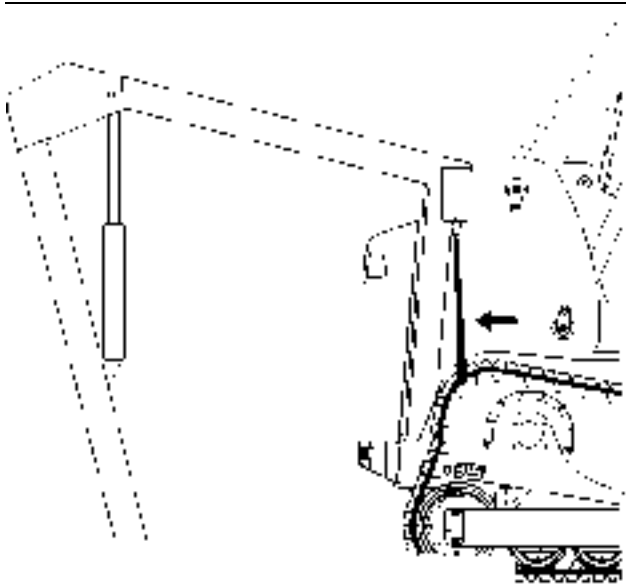

Illustration 193

g00954398

7. Use a lifting device that is suitable in order to lift the track. Lift the track in order to remove the drive sprocket. It may be necessary to insert a chock in front of the rear idler in order to prevent the track from spinning as you lift the track.

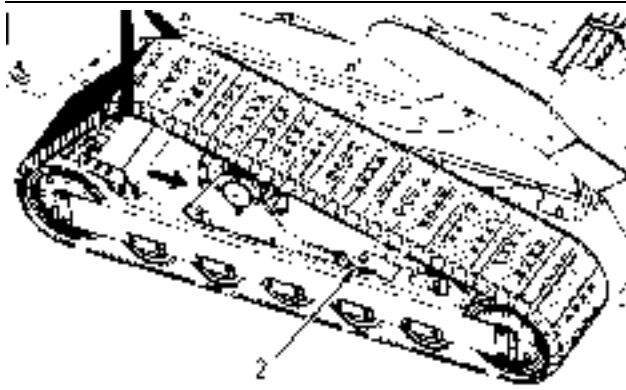

Illustration 194

g00954428

8. Use the track tensioner and slide the drive frame forward into the bracket. Fully insert one of the bolts for the drive frame through the bracket and the drive frame (2).
9. Remove the track tensioner.

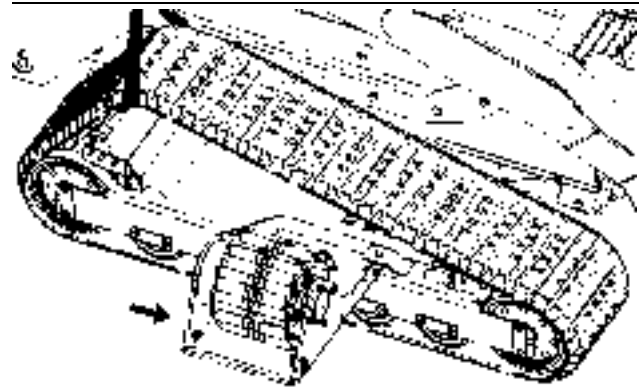

Illustration 195

g00954780

10. Swing the drive frame outward. This will provide clearance in order to remove the track.
11. Remove the lifting device.
12. Remove the track. Start by removing the track at the front of the machine. Slide the drive lugs of the track past the front idlers and continue toward the rear of the machine.

Installing the Track 287

1. Follow the steps in reverse order in order to replace the track.
2. Tighten the track to the proper tension. Refer to Operation and Maintenance Manual, "Track (Rubber) - Inspect/Adjust".

i01810053

Window Washer Reservoir - Fill (If Equipped)

SMCS Code: 7306-544-KE

NOTICE

When operating in freezing temperatures, use Caterpillar nonfreezing window washer solvent or equivalent. System damage can result from freezing.

i02107645



Illustration 196

g00925106

Fill the reservoir with window washer solvent.

i01085034

Window Wiper - Inspect/Replace (If Equipped)

SMCS Code: 7305-040; 7305-510

Inspect the condition of the windshield wiper blade. Replace the windshield wiper blade if the windshield wiper blade is worn or damaged. If the window wiper blade streaks the window, replace the window wiper blade.

i01037044

Windows - Clean (If Equipped)

SMCS Code: 7310-070

Use commercially available window cleaning solutions in order to clean the windows. Clean the outside of the windows from the ground unless handholds are available.

Work Tool - Lubricate

SMCS Code: 6700-086

Multipurpose Bucket

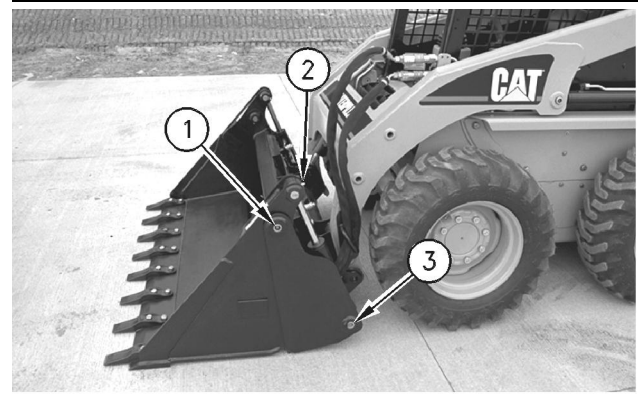

Illustration 197

g00534457

Apply lubricant to the grease fitting (1) for the pivot pin of the apron.

Apply lubricant to the grease fitting (2) for the rod end of the multipurpose bucket cylinder.

Apply lubricant to the grease fitting (3) for the head end of the multipurpose bucket cylinder.

Repeat for the other side of the bucket.

There are six grease fittings.

Utility Grapple Bucket and Utility Grapple Fork

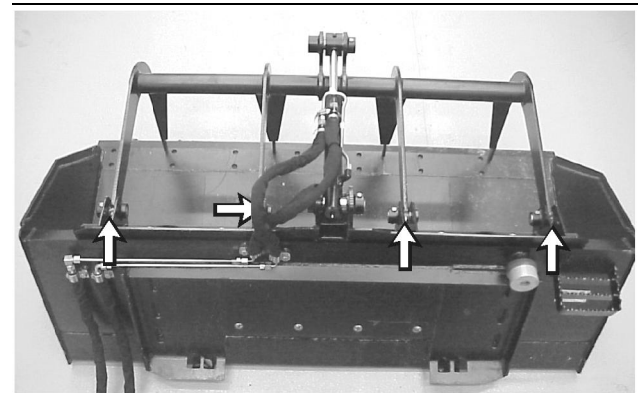

Illustration 198

g00647980

Apply lubricant to the four grease fittings for the grapples.

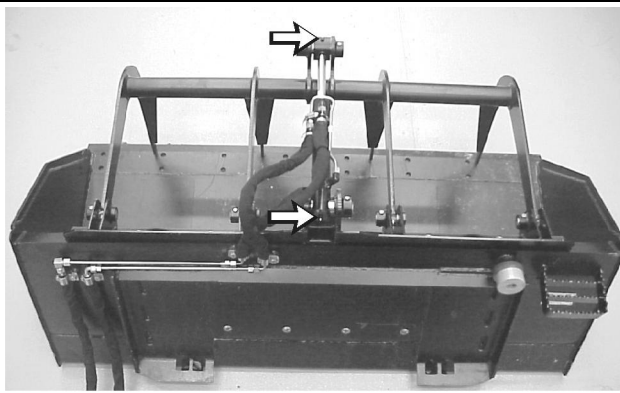

Illustration 199

g00647988

Apply lubricant to the two fittings for the grapple cylinder.

There are six grease fittings.

Industrial Grapple Bucket and Industrial Grapple Fork

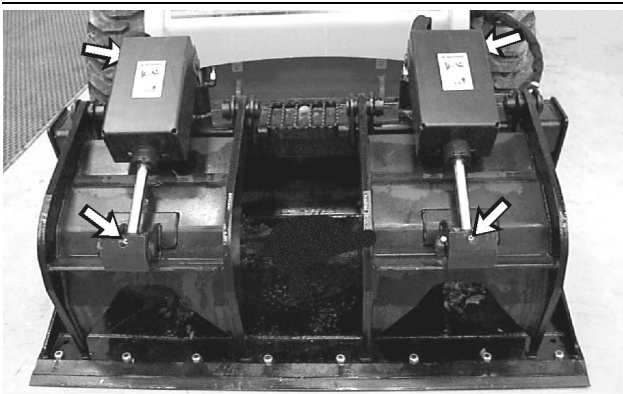

Illustration 200

g00645995

Apply lubricant to the four grease fittings for the fork cylinders.

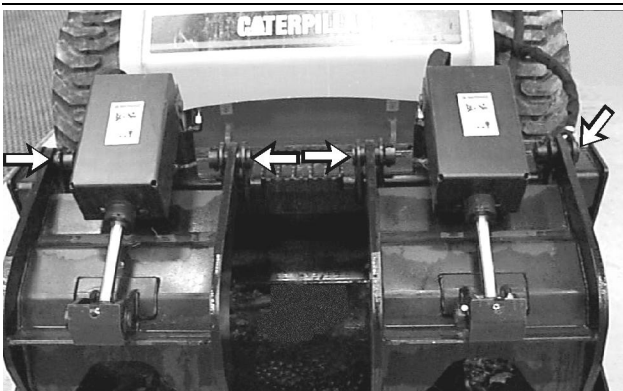

Illustration 201

g00646004

Apply lubricant to the four grease fittings for the two forks.

There are eight grease fittings.

Angle Blade

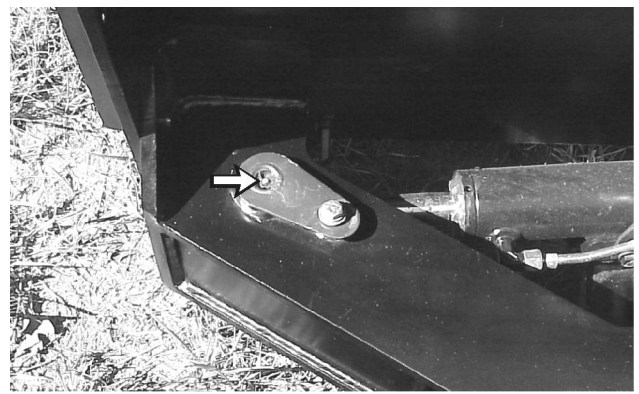

Illustration 202

g00648033

Apply lubricant to the grease fitting on the rod end of the angle cylinder.

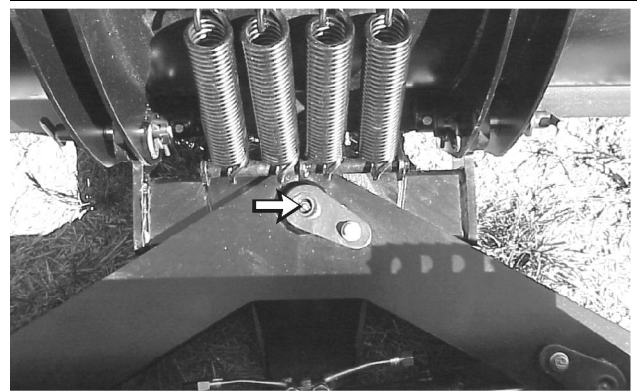

Illustration 203

g00648037

Apply lubricant to the grease fitting on the horizontal pivot point of the blade.

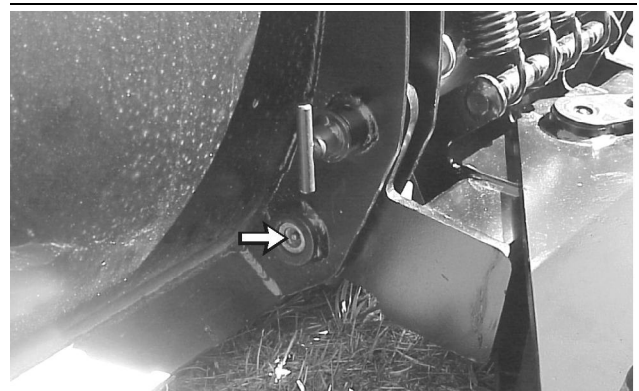

Illustration 204

g00648038

Apply lubricant to the grease fitting on the vertical pivot point of the blade. Repeat for opposite side of the blade.



Illustration 205

g00677570

This is a bottom view of the angle blade.

Apply lubricant to the grease fitting on the pivot point of the cylinder.

There are five grease fittings.

Dozer Blade

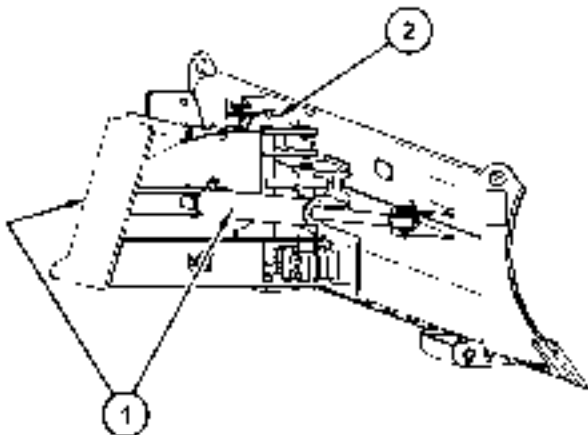

Illustration 206

g01073259

Apply lubricant to the grease fitting on both ends of the right hand angle cylinder (1). Repeat for opposite side of the blade.

Apply lubricant to the grease fitting on the pivot points on each end of the tilt cylinder (2).

There are six grease fittings.

i01809997

Work Tool Mounting Bracket - Inspect

SMCS Code: 6700-040-BK

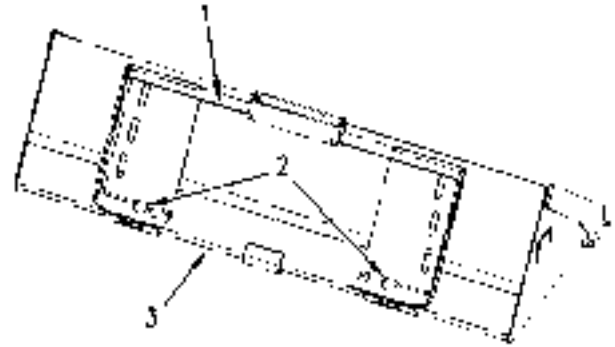

Illustration 207

g00925058

Inspect upper angled plate (1) and ensure that the plate is not bent or otherwise damaged. Inspect holes (2) for wear and for damage. Inspect lower angled plate (3) and ensure that the plate is not bent or otherwise damaged. If any wear is suspected or any damage is suspected, consult your Caterpillar dealer before you use the work tool.

Reference Information Section

Reference Materials

i02096537

Reference Material

SMCS Code: 1000; 7000

Cooling System

Special Publication, PEEP5027, "Label - ELC Radiator Label"

Special Publication, PEHP4036, "Product Data Sheet for Caterpillar ELC"

Special Publication, SEBD0518, "Know Your Cooling System"

Special Publication, SEBD0970, "Coolant and Your Engine"

Grease

Special Publication, NEDG6022, "Product Data Sheet for Multipurpose Lithium Complex Grease with Molybdenum (MPGM)"

Special Publication, NEHP5621, "How To Select The Right Grease For Any Job". This publication lists the typical characteristics for eleven of Caterpillar's greases.

Special Publication, PEHP0003, "Product Data Sheet for Multipurpose Lithium Complex Grease (MPG)"

Special Publication, PEHP0017, "Product Data Sheet for Special Purpose Grease (SPG) Bearing Lubricant"

Hydraulic Oil

Special Publication, PEHP0005, "Product Data Sheet for Caterpillar Hydraulic Oil (HYDO)"

Special Publication, PEHP6047, "Product Data Sheet for Caterpillar Biodegradable Hydraulic Oil (HEES)"

Miscellaneous Publications

Special Publication, PECP6026, "One Safe Source" English language for use in NACD

Special Publication, PECP6027, "One Safe Source" English language for use in COSA

Special Publication, PECP6028, "One Safe Source" English language for use outside NACD and COSA

Special Publication, PEHP8035, "Product Data Sheet for TDTO Transmission Multi-Season (TMS)"

Special Publication, REHS1199, "Installation Procedure for the Multi Terrain Loader Track Guide"

Special Publication, SEBD0717, "Diesel Fuels and Your Engine"

Special Publication, SEBU6250, "Caterpillar Machine Lubricant Recommendations"

Special Publication, SEBU5898, "Cold Weather Recommendations"

Special Publication, SENR5664, "Air Conditioning and Heater R-134a for All Caterpillar Machines"

Special Publication, SMBU6981, "Emissions Control Warranty Information"

Oil

Special Publication, LEDQ7315, "CG-4 Oil The Preferred Oil for Caterpillar Engines"

Special Publication, PEHP3050, "Product Data Sheet for Caterpillar Multipurpose Tractor Oil (MTO)"

Special Publication, PEHP6001, "How to Take a Good Oil Sample"

Special Publication, PEHP7041, "Product Data Sheet for Caterpillar Diesel Engine Oils (DEO)" CG-4 engine oils (International markets)

Special Publication, PEHP7508, "Product Data Sheet for Caterpillar Gear Oil (GO)"

Special Publication, PEHP8038, "Product Data Sheet for Caterpillar Diesel Engine Oils (DEO)", CH-4 engine oils (North America and Australia)

Special Publication, SEBD0640, "Oil and Your Engine"

Operation and Maintenance Manuals

Operation and Maintenance Manual, SEBU5898, "Cold Weather Recommendations"

Operation and Maintenance Manual, SMBU6981, "Emissions Control Warranty Information"

Parts Manuals

Parts Manual, SEBP3272 267 CMP1-UP and 277 CNC1-UP

Parts Manual, SEBP3457 247 CML1-UP and 257 CMM1-UP

Parts Manual, SEBP3888 287 CNY1-UP

Power train Disassembly and Assembly Manuals

Power train Disassembly and Assembly Manual, RENR4815CMP1-UP, CNC1-UP and CNY1-UP

Power train Disassembly and Assembly Manual, RENR4859CML1-UP and CMM1-UP

ROPS/FOPS Structure

Special Publication, SEBD1587, "What ROPS/FOPS Certification Means"

Special Publication, SEHS6929, "Inspection, Maintenance and Repair of ROPS and Attachment Installation Guidelines"

Safety Manuals

Safety Manual, SEBU5614

Service Manuals

Service Manual, RENR4820 CMP1-UP, CNC1-UP and CNY1-UP

Service Manual, RENR4850 CML1-UP and CMM1-UP

S-O-S Information

Special Publication, PEHP7057, "S-O-S Coolant Analysis"

Special Publication, TEJB1015, "Understanding the S-O-S Report"

Specifications Manuals

Specifications Manual, SENR3130, "Torque Specifications"

Additional Reference Material

ASTM D2896, "TBN Measurements" This can normally be obtained from your local technological society, from your local library, or from your local college.

SAE J183, "Classification" This can normally be found in the SAE handbook.

SAE J313, "Diesel Fuels" This can be found in the SAE handbook. Also, this publication can be obtained from your local technological society, from your local library, or from your local college.

SAE J754, "Nomenclature" This can normally be found in the SAE handbook.

Engine Manufacturers Association Lubricating Oils Data Book

Engine Manufacturers Association
Two North LaSalle Street, Suite 2200
Chicago, Illinois USA 60602
E-mail: ema@enginemanufacturers.org
Facsimile: (312) 827-8737
Phone: (312) 644-6610

i02115066

Caterpillar Approved Work Tools

SMCS Code: 6700

Only use Caterpillar approved work tools on this machine.

Note: Do not use a Caterpillar work tool on a machine that is not approved by Caterpillar.

Caterpillar approves the following work tools for use on this machine:

Table 24

Caterpillar Approved Work Tools for Multi Terrain Loaders					
Work Tool	247	257	267	277	287
General Purpose Bucket 1524 mm (60 inch)	(2)	(2)	(1)	(1)	(1)
General Purpose Bucket 1676 mm (66 inch)	(3)	(3)	(1)	(1)	(1)
General Purpose Bucket 1829 mm (72 inch)	(3)	(3)	(2)	(2)	(2)
General Purpose Bucket 1981 mm (78 inch)	(2)	(2)	(3)	(3)	(3)
Dirt Bucket 1372 mm (54 inch)	(1)	(1)	(1)	(1)	(1)
Dirt Bucket 1524 mm (60 inch)	(2)	(2)	(1)	(1)	(1)
Dirt Bucket 1676 mm (66 inch)	(3)	(3)	(1)	(1)	(1)
Dirt Bucket 1829 mm (72 inch)	(3)	(3)	(2)	(2)	(2)
Utility Bucket 1524 mm (60 inch)	(2)	(2)	(1)	(1)	(1)
Utility Bucket 1676 mm (66 inch)	(3)	(3)	(1)	(1)	(1)
Utility Bucket 1829 mm (72 inch)	(3)	(3)	(3)	(3)	(3)
Light Material Bucket 1829 mm (72 inch)	(3)	(3)	(2)	(2)	(2)
Light Material Bucket 1981 mm (78 inch)	(2)	(2)	(3)	(3)	(3)
Light Material Bucket 2134 mm (84 inch)	(2)	(2)	(3)	(3)	(3)
Multipurpose Bucket 1524 mm (60 inch)	(2)	(2)	(1)	(1)	(1)
Multipurpose Bucket 1676 mm (66 inch)	(3)	(3)	(1)	(1)	(1)
Multipurpose Bucket 1829 mm (72 inch)	(3)	(3)	(2)	(2)	(2)
Multipurpose Bucket 1981 mm (78 inch)	(2)	(2)	(3)	(3)	(3)
Pallet Forks 910 mm (36 inch) fork tine	(3)	(3)	(3)	(3)	(3)
Pallet Forks 1070 mm (42 inch) fork tine	(3)	(3)	(3)	(3)	(3)
Pallet Forks 1220 mm (48 inch) fork tine	(3)	(3)	(3)	(3)	(3)
Utility Fork 1676 mm (66 inch)	(4)	(4)	(4)	(4)	(4)
Utility Fork 1829 mm (72 inch)	(4)	(4)	(4)	(4)	(4)
Material Handling Arm	(3)	(3)	(3)	(3)	(3)

(continued)

(Table 24, contd)

Caterpillar Approved Work Tools for Multi Terrain Loaders					
Work Tool	247	257	267	277	287
Industrial Grapple Bucket 1524 mm (60 inch)	(2)	(2)	(1)	(1)	(1)
Industrial Grapple Bucket 1676 mm (66 inch)	(3)	(3)	(1)	(1)	(1)
Industrial Grapple Bucket 1829 mm (72 inch)	(3)	(3)	(2)	(2)	(2)
Industrial Grapple Bucket 1981 mm (78 inch)	(3)	(3)	(2)	(2)	(2)
Industrial Grapple Fork 1676 mm (66 inch)	(4)	(4)	(4)	(4)	(4)
Industrial Grapple Fork 1829 mm (72 inch)	(4)	(4)	(4)	(4)	(4)
Utility Grapple Bucket 1676 mm (66 inch)	(3)	(3)	(1)	(1)	(1)
Utility Grapple Bucket 1829 mm (72 inch)	(3)	(3)	(2)	(2)	(2)
Utility Grapple Fork 1676 mm (66 inch)	(4)	(4)	(4)	(4)	(4)
Utility Grapple Fork 1829 mm (72 inch)	(4)	(4)	(4)	(4)	(4)
Angle Blade 1829 mm (72 inch)	(2)	(2)	(1)	(1)	(1)
Angle Blade 2134 mm (84 inch)	(3)	(3)	(2)	(2)	(2)
Dozer Blade 2006 mm (79 inch)	(3)	(3)	(2)	(2)	(2)
Dozer Blade 2336 mm (92 inch)	(2)	(2)	(3)	(3)	(3)
A13 Auger	(3)	(3)	(3)	(3)	(3)
A19 Auger	(2)	(2)	(3)	(3)	(3)
A26 Auger	(4)	(4)	(4)	(4)	(4)
LT13 Landscape Tiller	(3)	(3)	(1)	(1)	(1)
LT18 Landscape Tiller	(3)	(3)	(3)	(3)	(3)
LR15 Landscape Rake	(3) (5)	(3) (5)	(1)	(1)	(1)
LR18 Landscape Rake	(3) (5)	(3) (5)	(3) (5)	(3) (5)	(3) (5)
Glenmack Harley Power Box Rake	(3)	(3)	(3)	(3)	(3)
PC3 Cold Planer	(3)	(3)	(3)	(3)	(3)
PC4 Cold Planer	(3)	(3)	(3)	(3)	(3)
PC6 Cold Planer	(4)	(4)	(4)	(4)	(4)
PC9 Cold Planer	(4)	(4)	(4)	(4)	(4)
PC203 Cold Planer	(3)	(3)	(3)	(3)	(3)
PC204 Cold Planer	(2)	(2)	(3)	(3)	(3)

(continued)

(Table 24, contd)

Caterpillar Approved Work Tools for Multi Terrain Loaders					
Work Tool	247	257	267	277	287
PC205 Cold Planer	(4)	(4)	(4)	(4)	(4)
PC206 Cold Planer	(4)	(4)	(4)	(4)	(4)
PC210 Cold Planer	(4)	(4)	(4)	(4)	(4)
H50 Hammer	(3)	(3)	(4)	(4)	(4)
H50S Hammer	(3)	(3)	(4)	(4)	(4)
H63 Hammer	(2)	(2)	(3)	(3)	(3)
H63S Hammer	(2)	(2)	(3)	(3)	(3)
SG16 Stump Grinder	(3)	(3)	(3)	(3)	(3)
SG18 Stump Grinder	(4)	(4)	(4)	(4)	(4)
CV16 Vibratory Compactor	(3)	(3)	(1)	(1)	(1)
CV18 Vibratory Compactor	(3)	(3)	(3)	(3)	(3)
BP15 Pickup Broom	(3)	(3)	(1)	(1)	(1)
BP18 Pickup Broom	(3)	(3)	(3)	(3)	(3)
BA18 Angle Broom	(3)	(3)	(3)	(3)	(3)
T9 Trencher	(4)	(4)	(4)	(4)	(4)
T15 Trencher	(4)	(4)	(4)	(4)	(4)
S305 Demolition and Scrap Shear	(1)	(3)	(3)	(3)	(3)
SR17 Snowblower	(2)	(2)	(1)	(1)	(1)
SR18 Snowblower	(3)	(3)	(1)	(1)	(1)
SR21 Snowblower	(2)	(2)	(3)	(3)	(3)
BH27 Backhoe	(3)	(3)	(4)	(4)	(4)
BH30 Backhoe	(3)	(3)	(4)	(4)	(4)
BH30 w Backhoe	(4)	(4)	(3)	(3)	(3)

- (1) This work tool is not recommended for use with this machine.
- (2) The machine performance is acceptable with this work tool.
- (3) The machine performance is optimum with this work tool.
- (4) This work tool is not approved for use on this machine.
- (5) This work tool has a lift restriction on this machine. Do not raise the lower pivot pin higher than 1 m (3 ft) above the ground.

If one is provided, refer to the Operation and Maintenance Manual of the work tool for the proper use of the work tool.

Note: Do not use any unapproved work tools on this machine.

Contact your Caterpillar dealer concerning specific work tools that are approved by Caterpillar for this machine. This list was complete at the time of publication. There may be additional work tools that have been approved since that time. Consult your Caterpillar dealer for an updated list of approved work tools.

i00852444

Decommissioning and Disposal

SMCS Code: 1000; 7000

Decommissioning and disposal will vary with local regulations. Consult the nearest Caterpillar dealer for additional information.

Index

A

Access Doors and Covers	88
Engine Access Door	88
Alert Indicators.....	64
Alternate Exit	54
Axle Bearings - Lubricate	100

B

Backup Alarm - Test	100
Battery - Recycle	100
Battery or Battery Cable - Inspect/Replace	100
Before Operation	28, 48
Before Starting Engine	27
Belts - Inspect/Adjust/Replace.....	101
Bogie and Idler - Inspect/Replace	102
Replacement for the 247B and 257B.....	103
Replacement for the 267B and 277B.....	104
Replacement for the 287B	105
Bogie and Idler Oil Level - Check.....	105
Bucket Cutting Edges - Inspect/Replace	106
Bucket Tips - Inspect/Replace	106
Burn Prevention.....	24
Batteries.....	25
Coolant.....	24
Oils.....	25

C

Cab Air Filter - Clean/Replace (If Equipped)	107
Fresh Air Filter	107
Recirculation Filter	107
Cab Tilting	88
Application Guide for Gas Struts.....	89
Tilting the Cab Downward.....	89
Tilting the Cab Upward	88
Capacities (Refill)	96
Caterpillar Approved Work Tools.....	147
Circuit Breakers and Fuses - Reset/Replace	107
Cooling System Coolant (ELC) - Change.....	108
Cooling System Coolant Extender (ELC) - Add....	110
Cooling System Level - Check	111
Cooling System Water Temperature Regulator - Replace.....	111
Crushing Prevention and Cutting Prevention	24

D

Daily Inspection	48
247 Service Interval Chart	50
257 and 287 Service Interval Chart	51
267 and 277 Service Interval Chart	52
Service Intervals	52
Decommissioning and Disposal	150

E

Electrical Storm Injury Prevention	27
Emissions Certification Film	46
Engine Air Filter Primary Element - Clean/Replace	112
Engine Air Filter Secondary Element - Replace ...	113
Engine Air Filter Service Indicator - Inspect	114
Engine Compartment - Clean	115
Air Conditioning Condenser	115
Engine Crankcase Breather - Clean.....	116
Engine Crankcase Breather (Closed Circuit) - Replace.....	115
Engine Oil and Filter - Change	117
Engine Oil Level - Check.....	117
Engine Oil Sample - Obtain	117
Engine Starting	27, 65
Engine Starting (Alternate Methods)	86
Engine Starting with Jump Start Cables.....	86, 119
Engine Valve Lash - Check	120
Equipment Lowering with Engine Stopped.....	29, 79
Lowering the Equipment with the Accumulator Charged	80
Lowering the Equipment with the Accumulator Discharged	80

F

Fire Extinguisher Location	27
Fire Prevention and Explosion Prevention	25
Ether	26
Fire Extinguisher	26
Lines, Tubes and Hoses	26
Foreword	5
California Proposition 65 Warning	4
Caterpillar Product Identification Number	5
Certified Engine Maintenance.....	4
Literature Information.....	4
Machine Capacity	5
Maintenance	4
Operation	4
Safety.....	4
Fuel Injection Timing - Check	120
Fuel System Filter - Replace	120
Fuel System Primary Filter (Water Separator) - Drain	121
Fuel System Primary Filter (Water Separator) Element - Replace	122
Fuel System Priming Pump - Operate.....	122
Fuel Tank Cap - Clean.....	123
Fuel Tank Water and Sediment - Drain	123

G

General Hazard Information 22
 Asbestos Information 23
 Containing Fluid Spillage 23
 Dispose of Waste Properly 24
 Fluid Penetration 23
 Pressurized Air and Water 22
 Trapped Pressure 23
 General Information 32
 Guards (Operator Protection) 30
 Other Guards (If Equipped) 30
 Rollover Protective Structure (ROPS), Falling
 Object Protective Structure (FOPS) or Tip Over
 Protection Structure (TOPS) 30

H

Hydraulic Oil Sample - Obtain 124
 Hydraulic System Oil - Change 124
 Hydraulic System Oil Filter - Replace 125
 Hydraulic System Oil Level - Check 126

I

Identification Information 46
 Important Safety Information 2

L

Lift Arm and Cylinder Linkage - Lubricate 126
 Lifting and Tying Down the Machine 83
 Lifting the Machine 83
 Tying Down the Machine 84
 Loader Lift Arm Brace Operation 90
 Disengage the Lift Arm Brace (Extended Lift) 92
 Disengage the Lift Arm Brace (Radial Lift) 91
 Engage the Lift Arm Brace (Extended Lift) 91
 Engage the Lift Arm Brace (Radial Lift) 90
 Lower Machine Frame - Clean 127
 Lubricant Viscosities 94
 Lubricant Viscosities and Refill Capacities 94

M

Machine Operation 54
 Machine Storage Procedure 80
 Maintenance Access 88
 Maintenance Interval Schedule 98
 Maintenance Section 88
 Maintenance Support 97
 Material Handling Arm Operation 72
 One Person Operation 74
 Two Person Operation 73
 Mounting and Dismounting 48
 Alternate Exit 48

O

Oil Filter - Inspect 127
 Inspect a Used Filter for Debris 127
 Operation 28, 66
 Operation Information 66
 General Information 66
 Operating on a Slope 67
 Operating on a Transition 68
 Track Guides 68
 Operation Section 48
 Operator Controls 56
 Accelerator Control (7) 58
 Air Conditioner Control (32) 63
 Automatic Level Control (26) 62
 Auxiliary Electrical Control (24) 61
 Auxiliary Hydraulic Control (23) 61
 Basic Operation 63
 Beacon Switch (17) 60
 Cab Dome Light (18) 60
 Continuous Flow and Interlock Override (27) 62
 Engine Start Switch (3) 58
 Fan Speed Control (31) 63
 Front Work Lights (15) 60
 Fuel Level Gauge (20) 61
 Glow Plug Starting Aid (4) 58
 Governor Control (6) 58
 Hazard Flashers (13) 60
 Horn (11) 60
 Hydraulic Shutoff Control (22) 61
 Interlock Control (1) 58
 Machine Security System (If Equipped) 63
 Parking Brake Control (5) 58
 Plugged (25) 62
 Rear Auxiliary Hydraulic Control or Fourth Function
 Control (28) 62
 Rear Work Lights (16) 60
 Rooding Lights (14) 60
 Seat Adjustment (2) 58
 Security Management 63
 Service Hour Meter (19) 61
 Speed and Direction Control (8) 59
 Suspension Seat (30) 63
 Temperature Control (29) 63
 Turn Signals (12) 60
 Window Wiper and Window Washer (21) 61
 Work Tool Control (9) 59
 Work Tool Coupler Control (10) 60

P

Pallet Forks Operation 75
 Parking 29, 79
 Plate Locations and Film Locations 46
 Product Information Section 32

Q

Quick Coupler - Inspect 128

R

Radiator Core - Clean.....	128
Radiator Tilting	92
Tilting the Radiator Guard.....	92
Rated Load	32
Bucket Rated Load	32
Rated Load with a Material Handling Arm	42
Rated Loads for Forks	39
Reference Information Section.....	146
Reference Material	146
Additional Reference Material.....	147
Cooling System.....	146
Grease	146
Hydraulic Oil.....	146
Miscellaneous Publications.....	146
Oil.....	146
Operation and Maintenance Manuals	146
Parts Manuals.....	147
Power train Disassembly and Assembly Manuals.....	147
ROPS/FOPS Structure	147
S-O-S Information	147
Safety Manuals	147
Service Manuals	147
Specifications Manuals	147
Reference Materials	146
Refrigerant Dryer - Replace (If Equipped).....	129
Roading the Machine.....	83
Rollover Protective Structure (ROPS) and Falling Object Protective Structure (FOPS) - Inspect....	129

S

S-O-S Information	96
Safety Messages.....	6
Safety Section	6
Seat Belt.....	54
Extension of the Seat Belt	56
Seat Belt Adjustment for Non-Retractable Seat Belts	54
Seat Belt Adjustment for Retractable Seat Belts	55
Seat Belt - Inspect	130
Seat Belt - Replace.....	130
Shipping the Machine	82
Loading the Machine.....	82
Unloading the Machine	83
Sound Information and Vibration Information.....	29
Machine Vibration Levels.....	30
Sound Performance for Machines that are Offered in European Union Countries and in Countries that Adopt the EU Directives	29
Specifications	44
Sprocket - Inspect.....	131
Rings.....	131
Sleeves	131
Sprocket Bearings - Lubricate	132
Sprocket Retaining Nuts - Check	132
Stopping the Engine	79

Stopping the Engine if an Electrical Malfunction

Occurs	79
--------------	----

T

Table of Contents.....	3
Tilt Cylinder Bearings and Bucket Linkage Bearings - Lubricate	132
Towing Information	85
Towing the Machine.....	85
Retrieval of Machine	85
Track (Rubber) - Inspect/Adjust.....	133
Adjustment of the Drive Frame for the 267 and 277	135
Track Adjustment for the 247 and 257	133
Track Adjustment for the 267 and 277	134
Track Adjustment for the 287	135
Track (Rubber) - Remove/Replace.....	138
Installing the Track 247 and 257	139
Installing the Track 267 and 277	141
Installing the Track 287	142
Removing the Track 247 and 257	138
Removing the Track 267 and 277	140
Removing the Track 287	141
Transportation Information	82

W

Welding on Machines and Engines with Electronic Controls	97
Window Washer Reservoir - Fill (If Equipped)....	142
Window Wiper - Inspect/Replace (If Equipped)...	143
Windows - Clean (If Equipped).....	143
Work Tool - Lubricate.....	143
Angle Blade.....	144
Dozer Blade	145
Industrial Grapple Bucket and Industrial Grapple Fork.....	144
Multipurpose Bucket	143
Utility Grapple Bucket and Utility Grapple Fork.....	143
Work Tool Coupler Operation	69
Attaching the Work Tool	69
Releasing the Hydraulic System Pressure.....	72
Removing the Work Tool.....	71
Work Tool Mounting Bracket - Inspect.....	145
Work Tool Operation.....	76
Work Tools.....	28

Product and Dealer Information

Note: For product identification plate locations, see the section "Product Identification Information" in the Operation and Maintenance Manual.

Delivery Date: _____

Product Information

Model: 277 _____

Product Identification Number: _____

Engine Serial Number: _____

Transmission Serial Number: _____

Generator Serial Number: _____

Attachment Serial Numbers: _____

Attachment Information: _____

Customer Equipment Number: _____

Dealer Equipment Number: _____

Dealer Information

Name: _____ Branch: _____

Address: _____

Dealer Contact

Phone Number

Hours

Sales: _____

Parts: _____

Service: _____

