OPERATING MANUAL

FENDT

916 Vario

920 Vario

924 Vario

926 Vario

930 Vario



Vehicle type

Chassis No. **After-Sales Service**

Vehicle delivery

Vehicle pre-delivery inspection by the Service Workshop

For information, technical data etc. refer to Service Schedule.

- Check oil level, top up if necessary.**
Engine, transmission, axle drives, front axle differential, hub drives, front PTO, lift shaft lubrication. Fill the hydraulic system with additional oil for external consumers as per customer order.
- Check fluid level, and top up if necessary.**
Cooling system, clutch operation, brake actuation, air conditioning if installed.
- Grease vehicle as per Lubrication Chart, lubricate all joints.**
- Check steering and toe-in. Check tyre pressures. Check that wheel nuts are firmly attached.**
- Test electrical system. Check fault memory. Check battery charge status. Check the function and settings of the lighting and signalling system.**
- Fill up with diesel, use pre-filter if necessary.**
- Check that brakes are working effectively.**

Information to be given on vehicle delivery

- Draw attention to safety instructions within the Operating Manual and on the vehicle itself.**
- Information on keeping to country-specific regulations regarding vehicle speed and trailer braking systems.**
- Explain the following features in detail - see index - and show how they are operated. See also separate vehicle delivery test log.**
Operating controls, transmission, multiple display, initial start-up, starting, and switching off, fault display, code table, clearing the warning and fault messages.
- Explain "Important Information on Service and Maintenance". See inside back cover.**
- Hand over tool box accessories.**
- Fill in warranty and delivery card and forward immediately to the factory.**
- For 50 km/h version, draw attention to the required regular vehicle inspections (country-specific).**

Vehicle delivered on

Signature of mechanic

OPERATING MANUAL

FENDT 916 Vario

From chassis number 916 .. 7001

FENDT 920 Vario

From chassis number 920 .. 7001

FENDT 924 Vario

From chassis number 924 .. 7001

FENDT 926 Vario

From chassis number 926 .. 7001

FENDT 930 Vario

From chassis number 930 .. 2001

AGCO GmbH

Maschinen und Schlepperfabrik D-87616 Marktoberdorf / Bavaria / Germany
Telephone +49 8342 77-0 Facsimile +49 8342 77-222

Dear Customer,

Please note the following:

- Before using the tractor, carefully read through this Manual to familiarize yourself with all operating controls and their functions before you begin work. This also applies to the operating instructions of the implement manufacturer.
- Follow all the operating and maintenance instructions. If you do so, your tractor will give you many years of economic and trouble-free operation. You will find an overview of all maintenance operations in the Service Schedule in this Manual.
- Maintenance and repair work should be carried only at your service workshop. see also the "Important service and maintenance information".

Authorised use

This tractor is designed only for normal agricultural operations or similar purposes, for example in municipal applications.

Any other type of use is considered unauthorised. The manufacturer will not be liable for any damage resulting from such uses, which will be entirely at the owner's risk.

Authorised use also means fulfilling the operating, service and maintenance conditions set out by the manufacturer.

Operation, maintenance and repair of the tractor is restricted to persons who are familiar with this kind of work and aware of the inherent dangers.

All relevant accident prevention regulations and all generally accepted health & safety standards and road traffic regulations must be observed. The manufacturer does not accept liability for damage resulting from unauthorised modifications.

Marking of places that affect your safety

Make sure that any other users have read all the safety instructions as well.

The various levels of safety instructions can be distinguished as follows:

 **DANGER:**
Risk of serious accident.

 **WARNING:**
Risk of injury.

 **CAUTION:**
Possible risk of injury.

The Operating Manual is an integral part of the vehicle package and must be passed on to any subsequent owner in the event of resale. The attention of the new owner should be drawn to this information.

If this Manual is lost or damaged and you need a new one, please contact your Fendt dealer. There you will be able to purchase a replacement.

Vehicle Identification Number

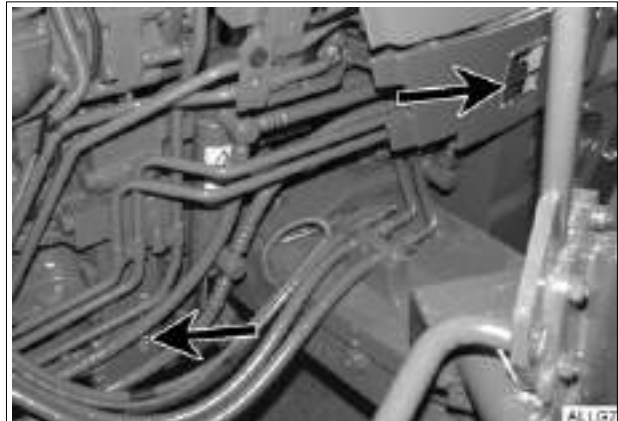

The Vehicle Identification Number is on the right frame and also stamped on the rating plate.

All specifications in the Manual are subject to the usual tolerances. We reserve the right to make design changes as part of technical further development, without making alterations to this Manual. The drawings and illustrations in the manual are used for function description, some of the items shown are not necessarily included in the vehicle delivery contents.

SAFETY INSTRUCTIONS.....9

OPERATION..... 14

1.	Driver seat	14			
1.1	Super deluxe seat	14	7.8	Cruise control	44
2.	Display instruments and operating controls.....	15	7.9	Load limit control	46
2.1	Front controls	15	7.10	Storing engine speeds	47
2.2	Glow and starter switch.....	16	7.11	Towing instructions	48
2.3	Combination switch	16	8.	Fuel consumption measurement.....	48
2.4	Steering wheel adjustment.....	16	8.1	Activating fuel consumption measurement.....	48
2.5	Quick reverse	16	9.	Tractor Management System (TMS).....	49
2.6	Dashboard	17	9.1	Engine management system	50
2.7	Indication of fluid levels.....	18	9.2	Accelerator mode	50
2.8	Operating status display	18	9.3	Setting engine speed range	51
2.9	Multiple display	19	10.	PTO.....	53
2.10	Operating controls, right.....	19	10.1	Rear PTO.....	53
2.11	Multi-function armrest	20	10.2	Engaging and disengaging rear PTO.....	54
2.12	Operating console, right side	21	10.3	Front PTO	55
2.13	Vario terminal.....	22	10.4	Engaging and disengaging front PTO.....	56
2.14	Camera function.....	26	10.5	Calibrating rear and front PTO coupling	56
2.15	Quick Jump	26	11.	Four wheel drive (4-WD).....	58
2.16	Cab top section, front.....	28	12.	Differential lock	58
2.17	Cab top right side.....	28	13.	Front axle suspension	59
2.18	Power outlets	29	14.	Power lift and PTO automatic mode	60
2.19	Reset function	31	14.1	Power lift automatic mode.....	60
3.	Heating and ventilation	31	14.2	PTO automatic mode	61
3.1	Heater with 3-speed blower	31	14.3	PTO automatic mode with power lift	62
3.2	Auxiliary ventilation in cab roof	32	15.	Brakes	63
3.3	Air conditioning	32	15.1	Foot brake	63
4.	Rearview mirror.....	33	15.2	Hand brake	63
5.	Start-up	33	15.3	Trailer brake	64
5.1	Daily check.....	33	15.4	Engine brake.....	64
5.2	Cold weather operation.....	34	16.	Steering.....	65
5.3	Tool box	34	16.1	Steering wheel adjustment.....	65
6.	Starting and stopping the engine.....	34	17.	Hydraulics.....	65
6.1	Memory function	34	17.1	General notes on hydraulic operations	65
6.2	Starting the engine	35	17.2	Valve locking.....	66
6.3	Jump starting	36	17.3	Valve equipment	67
6.4	Tow-starting	37	17.4	Operating the valves	67
6.5	Stopping the engine	37	17.5	Priority function	69
6.6	Stopping and immobilising the tractor.....	37	17.6	Setting the valves.....	70
7.	Vario transmission.....	37	17.7	External valve actuation.....	73
7.1	Joystick	37	17.8	Hydraulic connectors	74
7.2	Neutral position	37	18.	Electronic lifting gear control, rear	75
7.3	Selecting acceleration rates.....	38	18.1	Controls.....	75
7.4	Driving mode selector	39	18.2	EPC safety lock.....	76
7.5	Driving the tractor.....	40	18.3	Control panel functions	77
7.6	Changing direction of travel	42	18.4	Working with the EPC	79
7.7	Programmed changes of travel direction	43	18.5	Electronic slip control	81
			18.6	Electro-hydraulic external control.....	83

9.	Front PTO	149
10.	Transmission and axle drives.....	149
10.1	Changing the transmission oil.....	149
10.2	Checking the transmission oil level.....	150
10.3	Changing the oil in the axle drives	151
11.	Four-wheel drive axle	151
11.1	Changing the oil in the front axle differential gear	151
11.2	Replacing the oil in front axle hub drives	152
11.3	Front axle suspension.....	152
12.	Power lift.....	153
13.	Hydraulic system	153
13.1	Checking oil level in hydraulic system	153
13.2	Changing the hydraulic oil.....	154
13.3	Hydraulic oil filter.....	154
14.	Steering.....	156
15.	Front wheels.....	156
15.1	Checking toe-in	156
16.	Heating and ventilation	157
16.1	Removing the heater fan filter.....	157
16.2	Replacing the roof fan filter	157
16.3	Replacing the recirculating air filter.....	158
17.	Air conditioning	158
17.1	Condenser	158
17.2	Compressor V-belt	159
18.	Windshield washer system	159
19.	Cleaning the tractor	159
19.1	Clean the cab's air spring bellows.....	159
20.	Electrical and electronic systems	160
20.1	Battery.....	160
20.2	Alternator	160
20.3	Electrowelding.....	160
20.4	Adjusting the headlights.....	160
20.5	Adjusting the auxiliary headlampss.....	161
20.6	Auxiliary lights, Xenon headlights	161
20.7	Additional installation of electrical and electronic equipment.....	162
21.	Fuses.....	163
21.1	Fuse holder X050.....	164
21.2	Fuse holder X051.....	165
21.3	Fuse holder F060 - F067	166
21.4	Fuse holder (A013)	167
22.	Wiring diagrams.....	168
22.1	Legend for circuit diagrams.....	168
22.2	Colour coding for electric wires.....	171
22.3	Wiring diagrams	171

IMPLEMENTS	204
-------------------------	------------

1.	Reversing device	204
----	------------------------	-----

FAULTS AND REMEDIAL ACTIONS.....	205
---	------------

1.	Warning and fault messages	205
----	----------------------------------	-----

1.1	Warning messages	205
-----	------------------------	-----

1.2	Fault messages.....	211
-----	---------------------	-----

1.3	Clearing a warning or fault message	215
-----	---	-----

1.4	General faults.....	216
-----	---------------------	-----

2.	Variotronic Ti fault messages.....	223
----	------------------------------------	-----

3.	Warning and information messages for implement settings	227
----	---	-----

4.	Flame starting system faults	228
----	------------------------------------	-----

5.	Fault code tables.....	229
----	------------------------	-----

6.	Emergency operation	245
----	---------------------------	-----

TECHNICAL DATA.....	247
----------------------------	------------

1.	Technical data	247
----	----------------------	-----

2.	Tyre pressures	251
----	----------------------	-----

3.	Tyre combinations	252
----	-------------------------	-----

4.	Fuel and lubricants Vario 916 - 930.....	253
----	--	-----

4.1	Bio-diesel	254
-----	------------------	-----

4.2	Bio hydraulic oil.....	254
-----	------------------------	-----

5.	Lubrication chart.....	255
----	------------------------	-----

5.1	Filling points	255
-----	----------------------	-----

5.2	Lubrication points.....	256
-----	-------------------------	-----

Safety and accident prevention regulations

**WARNING:**

Before every operation, check the tractor for road worthiness and operational safety. Carefully read the Manual and observe all safety instructions.

Safety signs on the machine must be replaced if damaged or lost.

General safety and accident prevention regulations

1. Follow the general safety and accident prevention regulations, as well as the safety information in this manual.
2. When driving on public roads, follow the usual traffic regulations!
3. Before starting work, familiarise yourself with all operating controls and their functions. Don't wait until after you have started working!
4. Start the engine from the driver seat only. Do not attempt to start by shorting across the starter terminals, as this can cause the tractor to move immediately!
5. Before starting up, check the area is clear (e.g. children). Ensure that nothing obstructs vision.
6. Never leave the engine running in a confined space!
7. The driver should wear close-fitting clothing. Avoid wearing loose-fitting garments!
8. Take extra care when handling fuel - serious fire hazard. Never re-fuel in the presence of sparks or naked flames. Do not smoke when re-fuelling.
9. Before re-fuelling, turn off the engine and remove the ignition key. Do not re-fuel in confined spaces. Clean up spillages immediately!
10. To avoid fire hazard, keep the tractor clean.
11. Beware of leaking brake fluid and battery acid (these are toxic and corrosive).

Carrying passengers

1. Passenger should be carried only if the tractor is fitted with an appropriate passenger seat.
2. Do not carry passengers in any other other circumstances.

Driving the tractor

1. Driving speed must always be adapted to the current situation. Avoid sudden cornering when driving uphill or downhill, or across gradients. Disengage the differential lock when cornering. Never disengage the clutch to shift gears when travelling downhill!
2. Make sure all trailers and implements are properly hitched. Driving characteristics, steering and braking are affected by mounted implements, trailers and ballast weight. Therefore, always ensure that there is adequate steering and braking capacity.
3. Observe the maximum permissible gross vehicle weight, axle loads and tyre load capacity, especially if heavy implements are attached.
4. When negotiating bends with implements connected or hitched up, always allow for the overhang and oscillating weight of the implement.

Front loader operation

1. Never allow anyone to stand in the hazard area, or within the working range of the front loader. Keep the area clear of bystanders at all times. Do not operate the front loader unless there is a clear view of the entire working area - illuminate the area if necessary.
2. It is not permitted to use the standard loader (as supplied) as a working platform. If using the loader with a special working platform, additional safety measures are required.
3. Do not handle round bales, pallets etc. unless the loader is suitably equipped for this purpose. If loading objects that cannot be secured and may fall off, do not use the front loader unless the driving seat is protected by a robust canopy.

SAFETY INSTRUCTIONS

4. When the front loader is raised, the risk of the tractor tipping over is greater, and the braking effect at the rear axle may also be reduced. Adapt your driving style and ensure adequate ballasting at the rear. For additional loading, we recommend attaching the Fendt 870 kg additional weight at the three-point link - fit wheel weights and fill the tyres if necessary.
5. Keep a safe distance from high-voltage cables.
6. When on public roads, bring the front loader into the transport position and secure it. Keep a maximum distance of 3.5 m between the implement and the centre of the steering wheel. If the forward projection exceeds 3.5 m, appropriate measures must be taken to guarantee safe traffic conditions (e.g. use people on foot acting as guides or mirrors at road junctions). Transporting equipment or materials with a front loader working implement, e.g. a scoop, is not permitted when travelling on public roads.
7. Danger from unintended lowering of the front loader. Always secure hydraulic lever at the end of operation. Before leaving the tractor, completely lower the front loader to the ground.
8. For safety reasons the front loader should be mounted and removed by one person only, the driver himself.
9. Always keep hands away from the crushing and cutting areas while parts may still be moving.
10. Detach the front loader with the attached implement (bucket, fork) only on firm and level ground. Always use the supports provided.
11. The front loader must be parked and secured in such a way as to prevent unauthorised persons or children from causing it to tip over.
12. When mounting the front loader, connect all hydraulic connections including the auxiliary return, if equipped in this way. Always connect hydraulic hose for cylinder load pressure to +. Take great care not to confuse connections since this may cause accidents through reversed functions, e.g. lifting instead of lowering. Before fitting the multiple coupler, remove the load from hydraulic hoses and unplug rear hydraulic connections, lower the power lift and operate only via EPC. Hydraulic fluid interflow can create danger from unintentional equipment motion.

Leaving the tractor

1. Make sure the tractor is properly secured against running off (parking brake, wheel chocks). Switch off the engine and apply the hand brake!
2. Remove the ignition key and lock the cab if necessary.
3. Never leave the tractor unattended while the engine is running.
4. Never leave the cab while the tractor is in motion.
5. Completely lower the mounted implement before leaving the tractor.

Mounted and trailing equipment

1. Only attach implements and trailers using the prescribed devices.
2. Use only trailers which comply with the country-specific regulations. Do not exceed maximum vertical bearing load. Ensure that the tractor-trailer brake system is functioning correctly.
3. Take special care when hitching trailers or implements!
4. Secure trailers and implements to prevent them rolling. Make sure that detached implements and components are safely parked.
5. Be sure all protection devices are correctly attached and in the safety position before operating the tractor.
6. When using the power lift, always remain well outside the travel range of the three-point link attachment!

PTO operation

1. Always switch off the engine, before fitting or removing the drive shaft. The PTO shaft must be in 0-position.
2. During PTO operations, allow no-one in the vicinity of the rotating PTO or drive shaft.
3. Make sure drive shaft and PTO are equipped with protective guards and sleeves.
4. After switching off the PTO, the attached implement may continue running due to the flywheel mass. In this case, do not go near the implement. Approach it only when it has come to a complete standstill.
5. When the drive shaft is removed, cover the PTO shaft with its protective cap.

Maintenance

1. Before maintenance and repair work, switch off the engine and remove the ignition key. Relieve pressure from implement lines, e.g. to the front loader.
2. Any person should keep clear of a lifted, unsecured load (e.g. tilted cab and similar).
3. Never open or remove any protection devices while the engine is running.
4. Never grasp leaking pressure lines. Pressurised fluids (diesel or hydr. oil) escaping under high pressure can penetrate the skin and cause severe injuries. If this has occurred, seek medical advice at once to avoid the risk of serious infection.
5. Keep at a safe distance from hot areas.
6. Hydraulic accumulator and connected pipes are highly pressurised. Only remove and repair in accordance with instructions provided in Technical Manual.
7. To avoid eye injury, do not look directly at the surface of the activated radar sensor.
8. Dispose of oil, fuels and filters properly!
9. For fitting tires, specialist knowledge and special mounting tools are required.
10. Run the tractor for a short time, then retighten all wheel nuts and bolts; check them regularly. For correct torque values refer to TECHNICAL DATA.
11. Before working on the electrical system, always remove the ground strap from the battery. Observe the following, when carrying out electric welding. When carrying out electric welding on tractor or mounted implements, make sure that both battery terminals are disconnected. Attach the ground terminal as close as possible to the welding point.
12. Spare parts must at least meet the technical requirements stated by the manufacturer. You can ensure that this is the case by using genuine spare parts!

Advice for front loader maintenance:

1. Before undertaking maintenance work, lower the front loader to the ground, switch off the engine and remove the ignition key.
2. If the pipe fracture protection has engaged, support the load before starting repairs, and slowly retract the cylinder.
3. Hydraulic hoses deteriorate with age. Check the condition of hydraulic hoses at regular intervals, and replace them in good time.
4. After attachment and repair operations, drive the tractor for a short time then retighten all mounting screws and nuts and check them regularly.
5. Retighten eccentric bolt for front loader attachment, if necessary.

SAFETY INSTRUCTIONS

Location of safety signs

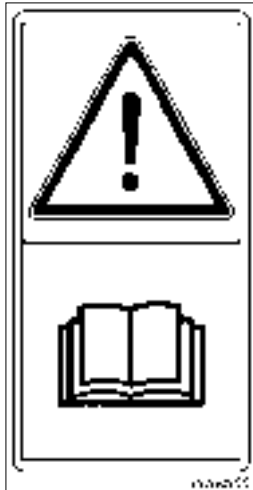

Fig.1

Inside the cab on the right.

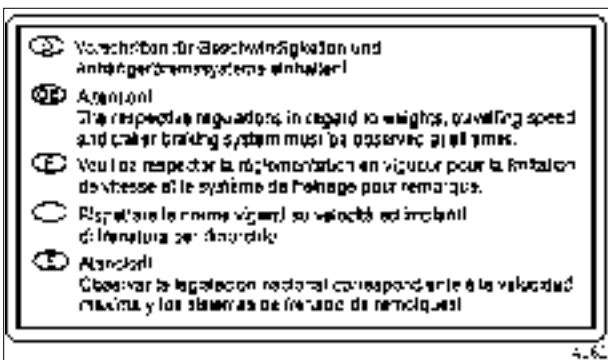

Fig.2

Inside the cab on the right.

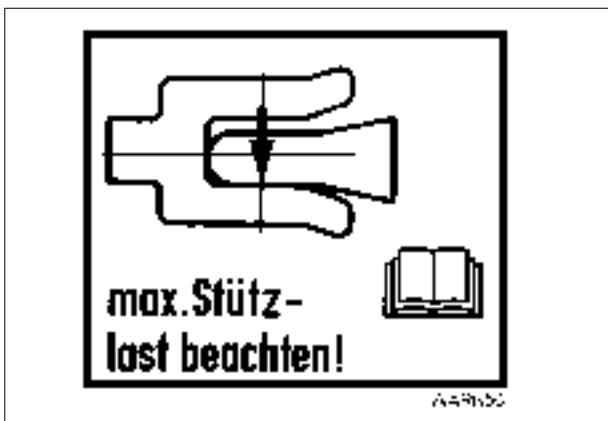

Fig.3

On the right rear mudguard.

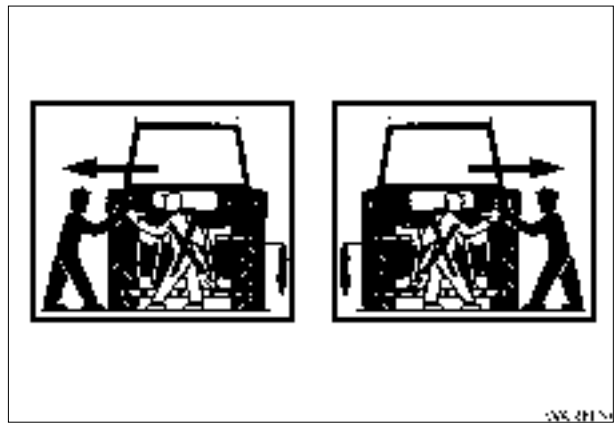

Fig.4

On the left and right rear mudguards beside the lifting gear control.



Fig.5

At left front of hydraulic cylinder of front axle suspension.



Fig.6

On pressure reservoir of front axle suspension.

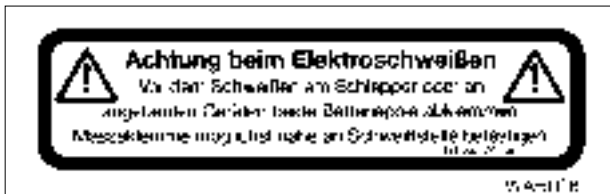

Fig.7

Inside the cab on left.

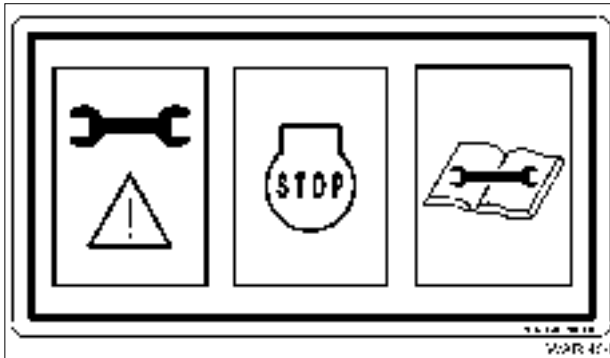

Fig.8

Inside the cab, on the cover of the emergency operation controls.

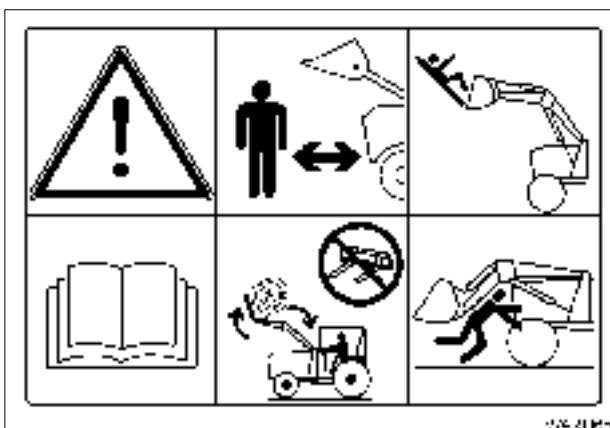

Fig.9

On the front loader forks, left and right.



Fig.10

Inside the cab, on the left, on the transverse beam of the front windscreen.

1. Driver seat



WARNING:

Never adjust the seat while the tractor is moving (risk of accident).
If a seat belt is available, always attach it.

1.1 Super deluxe seat



Fig.1

- A = Automatic weight and height adjustment.
- B = Swivel mechanism.
- C = Longitudinal adjustment.
- D = Backrest adjustment.
- E = Lumbar support (curvature), pneumatic operation.
- F = Seat bolster (depth adjustment).
- G = Seat bolster (tilt adjustment).
- H = Horizontal springing (on/off).
- I = Vertical springing (adjustable from soft to hard in four levels).
- J = Backrest extension.
- K = Behind the moulding:
Seat belt fixing point.
- L = Seat heating.

2. Display instruments and operating controls

2.1 Front controls

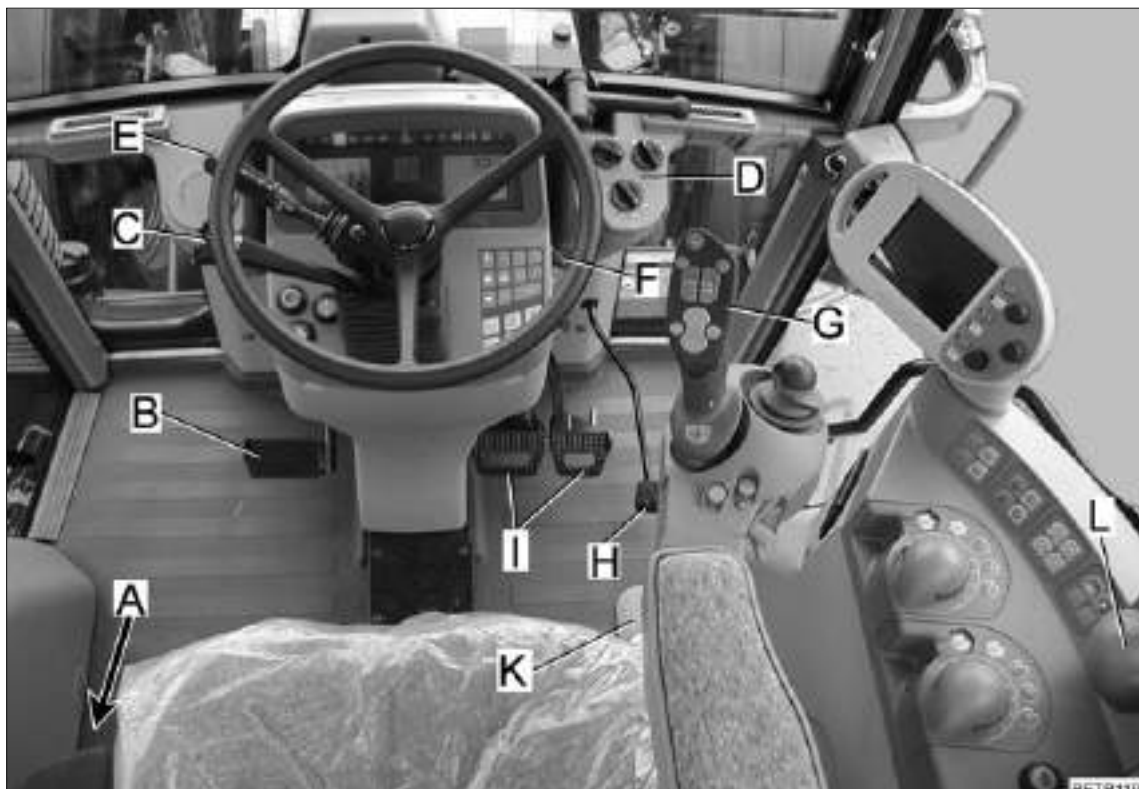

Fig.2

- A = Hand brake
- B = Clutch pedal
- C = Steering wheel adjustment and quick reverse.
- D = Heater and fan controls (see also OPERATION Section 3).
- E = Combination switch
- F = Heater starter switch
- G = Multi-function armrest
- H = Accelerator pedal
- I = Brake pedals
- K = Emergency operation controls (under the cover).
- L = Hand throttle

OPERATION

2.2 Glow and starter switch

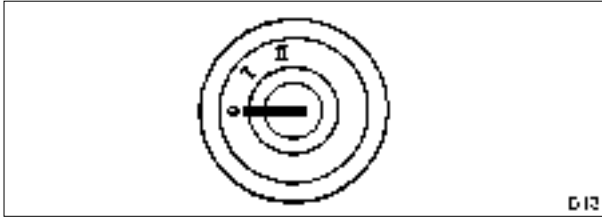

Fig.3

- 0 = Ignition off, key can be removed.
- I = General ignition, key cannot be removed + preheating (automatic).
- II = Starting + ignition.

2.3 Combination switch

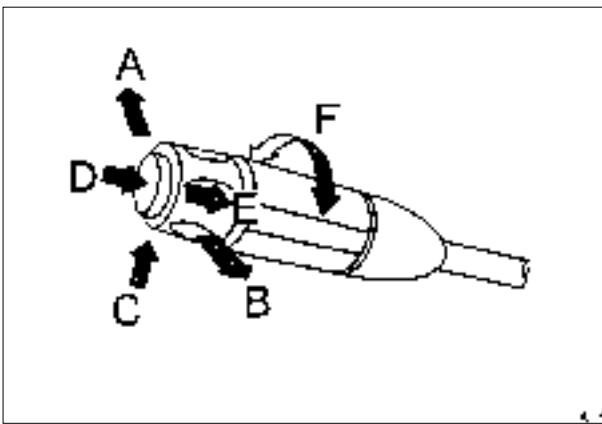

Fig.4

- A = Right indicator.
- B = Left indicator.
- C = 1. With lights switched on: toggle low beam, high beam.
2. With lights switched off headlight flasher.
- D = Horn
- E = Windshield washer system (wipers run automatically).
- F = Windshield wipers with intermittent and continuous operation.

2.4 Steering wheel adjustment

WARNING:
Never adjust the steering wheel while the tractor is moving!

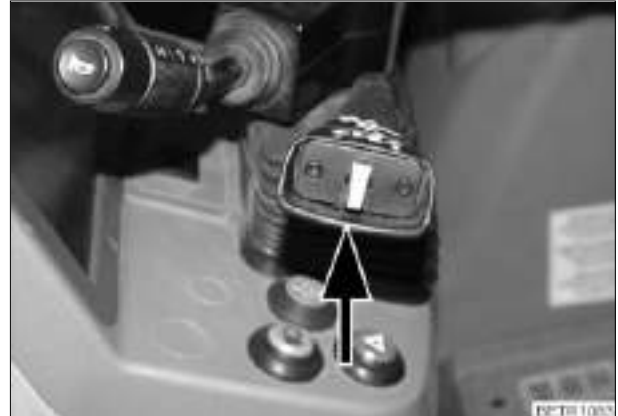

Fig.5

- Pull up lever and adjust steering wheel to the desired position (see also OPERATION Section 16).

2.5 Quick reverse

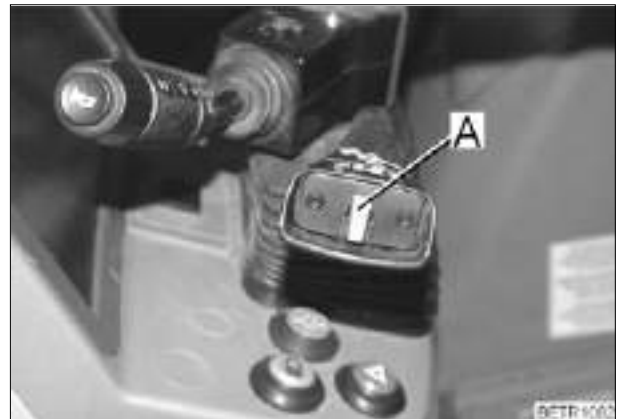

Fig.6

- Press button (A).

The tractor slows to a standstill, then accelerates in the opposite direction up to previous transmission ratio (see also OPERATION Section 7.6).

2.6 Dashboard

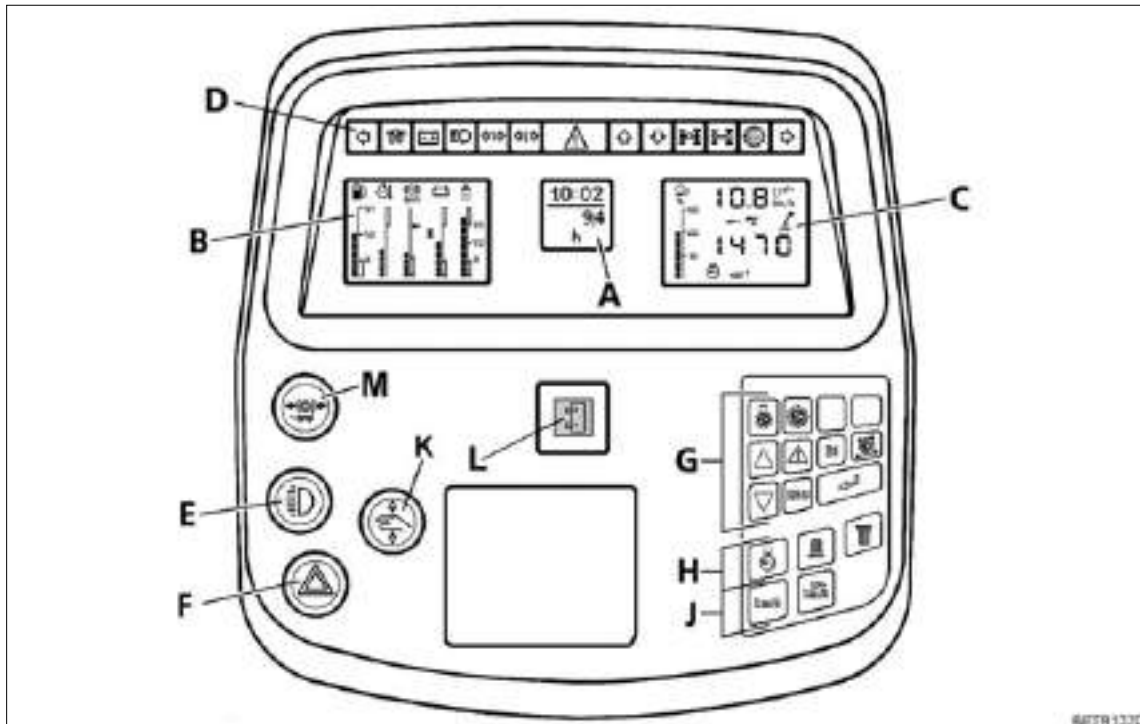

Fig.7

- | | |
|--|--|
| A = Multiple display | H = Key pad for rpm indicators (also see OPERATION Section 2.8). |
| B = Indication of fluid levels | J = Key pad for speed display (also see OPERATION Section 2.8). |
| C = Operating status display | K = Emergency mode (also see FAULTS AND REMEDIAL ACTIONS Section 6). |
| D = Indicator lamps | L = Alternator 1 not charging, red. |
| E = Lights including side lights | M = Hydraulic trailer brake (optional), (see also OPERATION Section 15.3). |
| F = Hazard warning flasher switch | |
| G = Key pad for on-board computer (also see OPERATION Section 26). | |

Left turn signal indicator, green.

Preheater indicator lamp, red.

Alternator 2 not charging, red.

High beam, blue.

1st trailer light indicator, green.

2nd trailer light indicator, green.

Hazard light, red.

Forward direction of travel, green.

Reverse direction of travel, green.

4-WD engaged, green.

Differential lock engaged, red.

Cruise control on.

Right turn signal indicator, green.

If one of the indicator lamps for forward/reverse fails, back-up indicators can be activated on the multiple display (A) activation (see see OPERATION Section 26.5).

Automatic dimmer

for forward/reverse indicator lamps, 4-WD, differential lock and related buttons.

At dusk or in the dark, the dimmer can be adjusted manually.

Brightness is increased or decreased by pressing one of the two buttons.



OPERATION

2.7 Indication of fluid levels

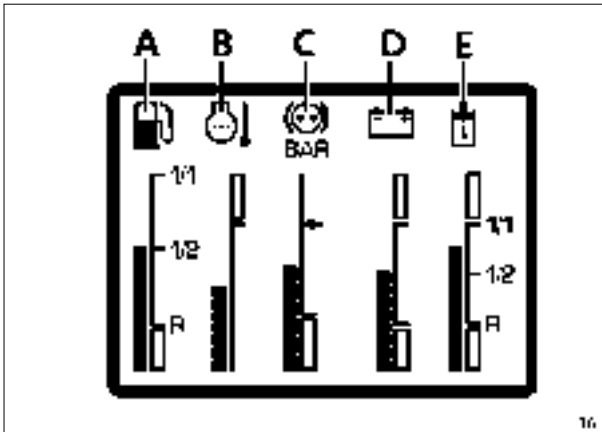

Fig.8

- A = Fuel supply
- B = Engine temperature
When the bar indicators reach the red zone, relieve the engine of load immediately and allow to cool down for about 2 minutes at 1000 rpm, then turn the engine off.
- C = Compressed air supply
- D = On-board electrical system voltage
- E = Hydraulic oil supply

2.8 Operating status display

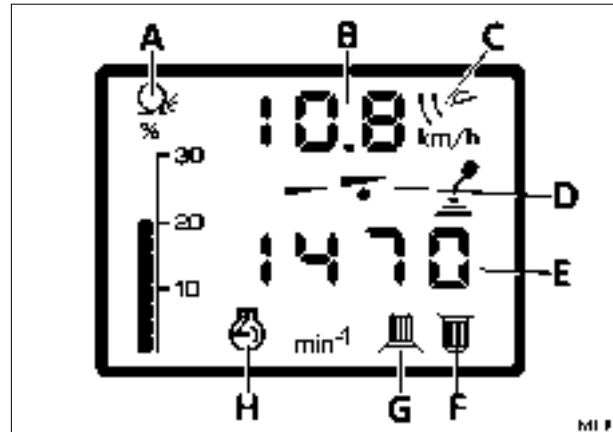



Fig.9

- A = Wheel slip in %;
(only if optional radar sensor is equipped).
- B = Tractor speed in km/h.

On tractors with the optional radar sensor, use these keys to change to:

 theoretical speed measurement calculated from transmission speed.

 actual speed based on signal from radar sensor, symbol (C) is lit.

Theoretical speed calculation is activated automatically when tractor speed is over 15 km/h, the wheel slip indicator (A) and symbol (C) then go out.

NOTE:

For a precise reading, adjust the speed indicator under operating conditions (see also OPERATION Section 26.2).

- D = Driving mode indicator
the selected driving mode is indicated by a spot (D).

- E = Rpm indicator
can be changed with the buttons to:

 engine speed symbol (H) is displayed.

 rear PTO speed symbol (F) is displayed.

 front PTO speed symbol (G) is displayed.

2.9 Multiple display

For warnings, fault messages and on-board computer functions.

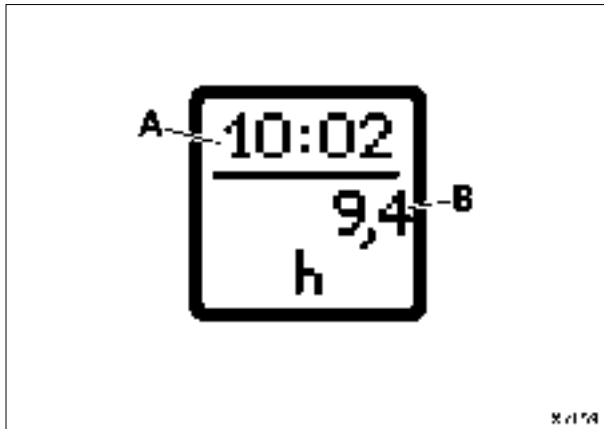

Fig.10

In the basic display, the clock (A) and operating hours (B) are indicated. This is interrupted for warnings, fault messages and on-board computer functions.

2.10 Operating controls, right

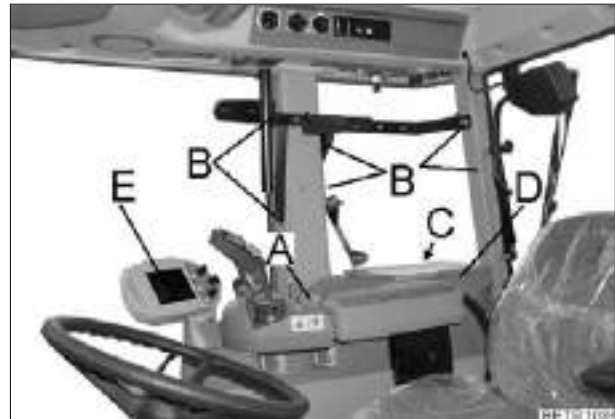

Fig.11

- A = Hand throttle
- B = Behind the moulding, M10 threaded holes for fixing additional equipment, e.g. radio or telephone, (see also CARE AND MAINTENANCE Section 20.7).
- C = Fuses
- D = Document box
- E = Control terminal

OPERATION

2.11 Multi-function armrest

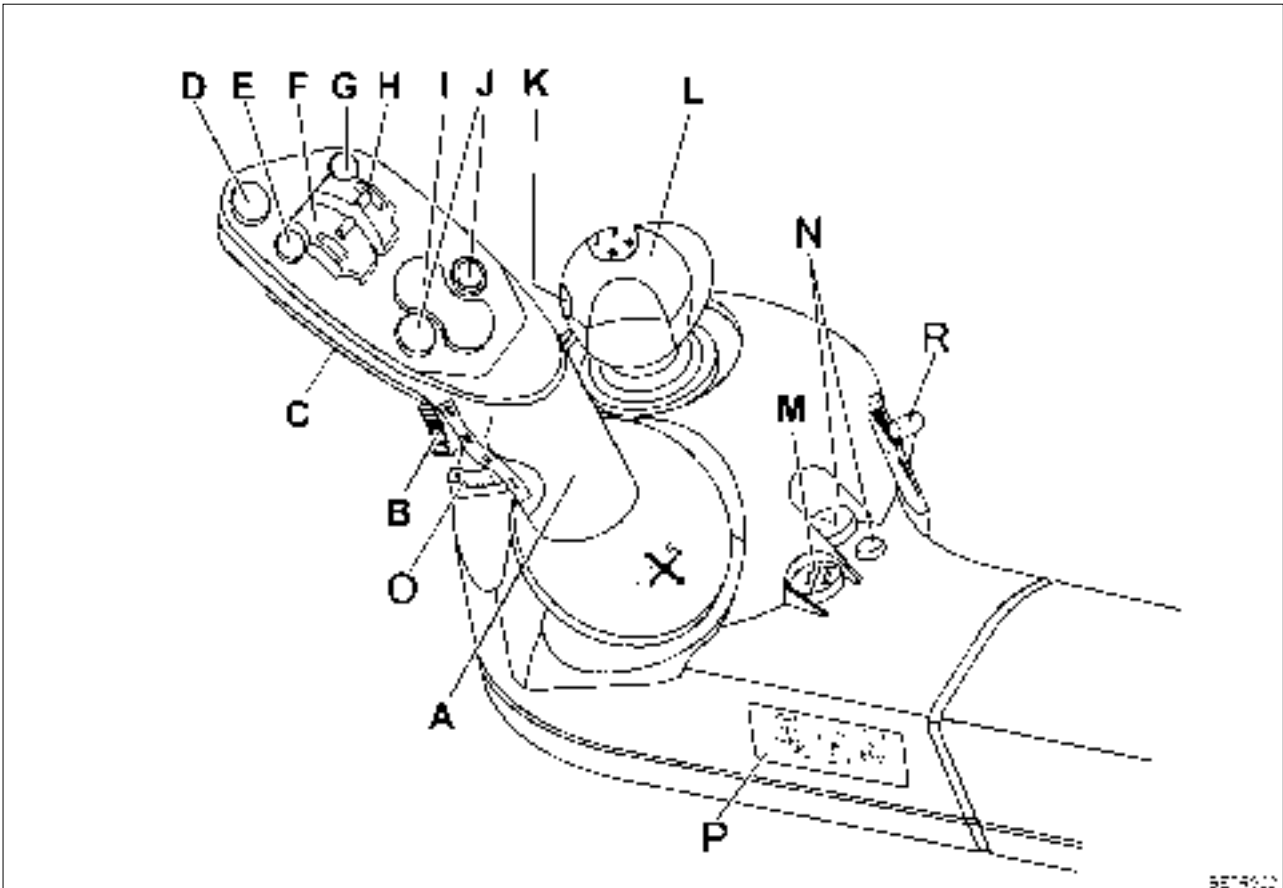

Fig.12

- A = Joystick (see also OPERATION Section 7.1).
- B = Acceleration rate selection (see also OPERATION Section 7.3).
- C = Activating button on the back of the joystick.
- D = EPC PTO automatic mode stop button (see also OPERATION Section 14.2).
- E = Floating position of hydraulic valve, green or blue (see also OPERATION Section 17.3).
- F = Lifting/lowering hydraulic valve, green or blue (see also OPERATION Section 17.3).
- G = Floating position of hydraulic valve red or yellow (see also OPERATION Section 17.3).
- H = Lifting/lowering of hydraulic valve red or yellow (see also OPERATION Section 17.3).
- I = Rear power lift/ PTO automatic mode (see also OPERATION Section 14.2).
- J = Front power lift/ PTO automatic mode (see also OPERATION Section 14.2).
- K = 3rd hydraulic circuit on front loader.
- L = Crossgate lever, lifting/lowering and floating position of hydraulic valves, yellow/blue or red/green (see also OPERATION Section 17.3).
- M = Driving mode selector (see also OPERATION Section 7.4).
- N = Neutral button with neutral selected LED (see also OPERATION Section 7.2).
- O = Accelerator pedal function (see also OPERATION Section 9.2).
- P = Electronic engine control (also refer to OPERATION Section 9).
- R = Accelerator pedal release (see also OPERATION Section 9.2).

2.12 Operating console, right side

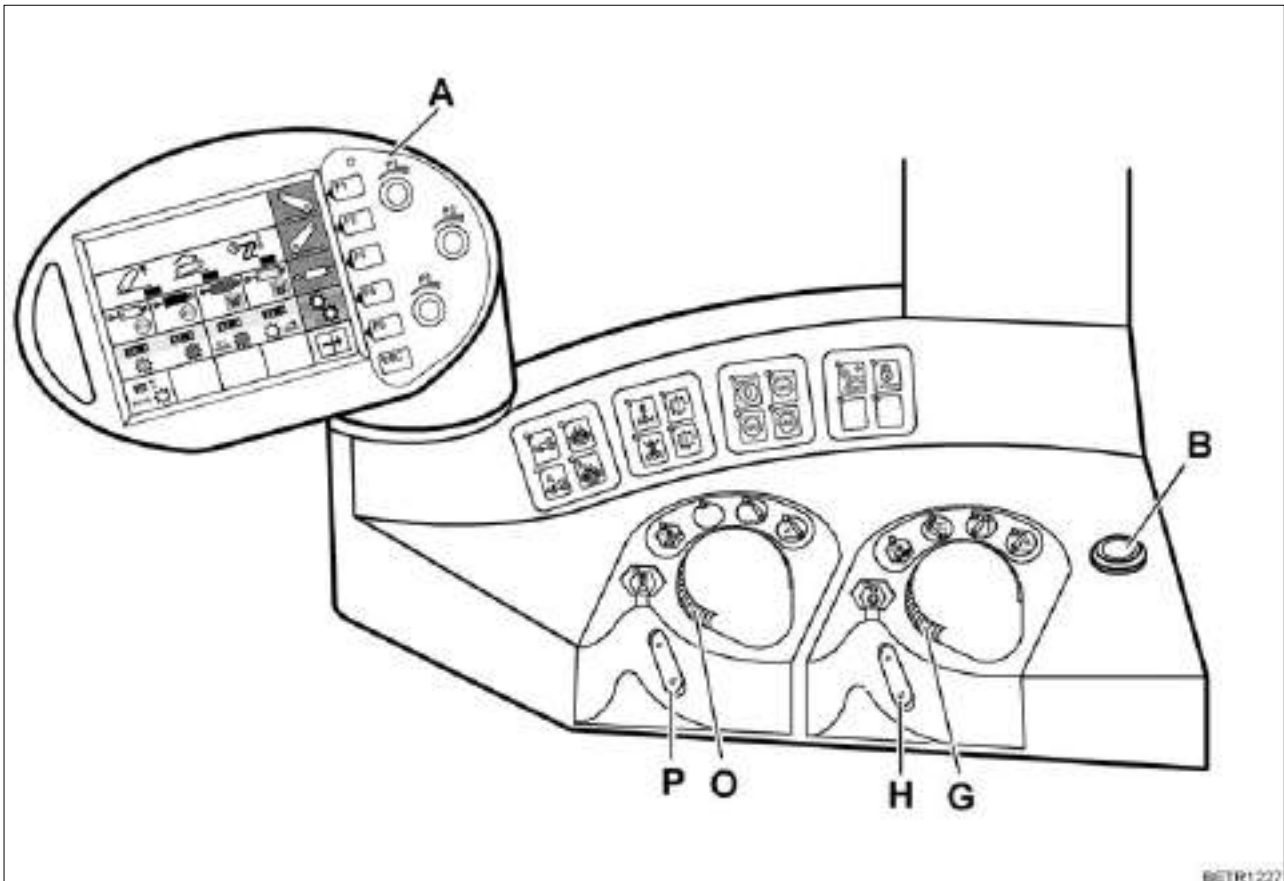











Fig.13

- A = Vario terminal (see also OPERATION Section 2.13).
- B = Additional headlamps (on front of roof; can be switched on only when the headlamps are on - these then go off).
- G = Depth regulation rear power lift.
- H = Quick lift rear power lift.
- O = Comfort front power lift depth control.
- P = Quick Lift, comfort front power lift.

Front PTO and front power lift operation (see also OPERATION Section 10.3, OPERATION Section 20.3).

-  PTO ON/OFF
-  PTO automatic mode
-  Floating position
-  EPC automatic mode

Rear PTO and rear power lift controls (see also OPERATION Section 10.1, OPERATION Section 18).

-  PTO ON/OFF
-  PTO automatic mode
-  Quick insert
-  Hitch-lift
-  EPC automatic mode

OPERATION

4-WD (see also OPERATION Section 11).

4-WD 100%; ON/OFF



4-WD automatic mode ON/OFF



Differential lock (see also OPERATION Section 12).

Differential lock 100 % ON/OFF



Differential lock automatic mode ON/OFF



Front axle suspension (also see OPERATION Section 13).

Suspension locked



Suspension ON



Tempomat cruise control (see also OPERATION Section 7.8).

Memory 1



Memorised speed 2



Hydraulic valves (see also OPERATION Section 17.3).

Hydraulic valve control

The operating functions of the crossgate lever and the controls on the joystick are interchanged.



Locking the hydraulic valves



Speed preselection for rear PTO (see also OPERATION Section 10.1).

PTO neutral



PTO 540



Economy PTO (750)



PTO 1000



2.13 Vario terminal

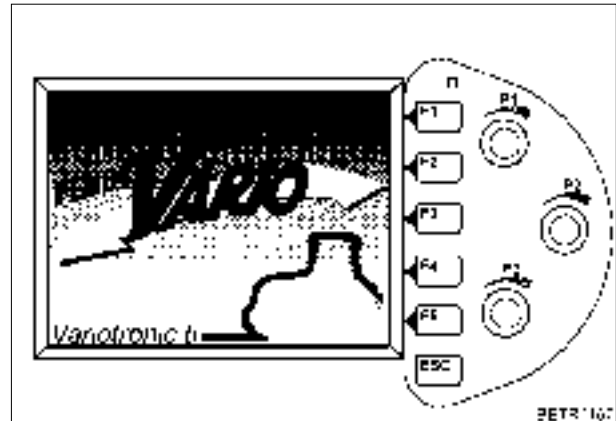

Fig.14

NOTE:

At low temperatures, a red-orange discolouration along with a decrease in contrast and delayed display may occur for up to 20 minutes.

At high temperatures there may be a loss of contrast.

After the start-up display, the following first main menu is displayed.

First main menu

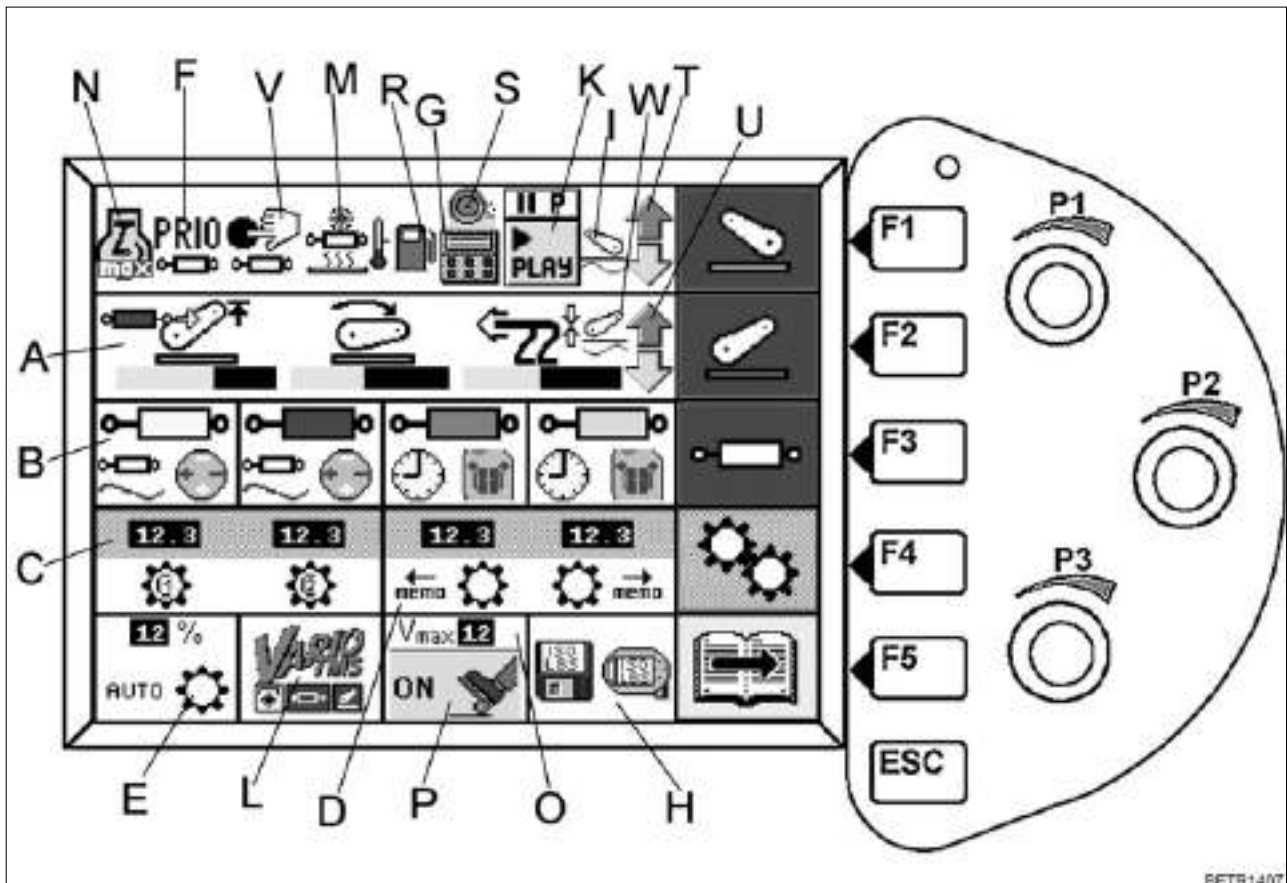

Fig.15

Pressing keys (F1 - F5) gives access to the following functions.

- F1 = Comfort front power lift
- F2 = Rear EPC
- F3 = Electric valves
- F4 = Transmission settings
- F5 = Switch to 2nd main menu level

Display of prevailing operating status of:

- A = Rear EPC
- B = Electric valves
- C = Cruise control
- D = Programmed changes in direction of travel
- E = Load limit control
- F = Prioritised valve
- G = Active on-board computer
- H = LBS-ISO function (optional)
- I = Front power lift - floating position
- K = Variotronic Ti - function display
- L = Tractor Management System
- M = Hydraulic valve heating
- N = Stored engine speed activated
- O = Accelerator range
- P = Accelerator pedal drive active
- R = Measuring fuel consumption
- S = Slip control active (optional)
- T = Front EPC active
- U = Rear EPC active
- V = External valve actuation
- W = Rear power lift - floating position

OPERATION

Second main menu

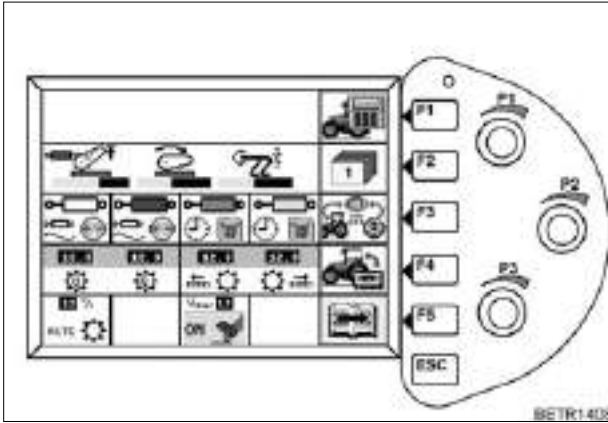

Fig.16

Pressing keys (F1 - F5) gives access to the following functions.

- F1 = On-board computer
- F2 = Store terminal settings
- F3 = Implement control
- F4 = Variotronic Ti
- F5 = Switch to third menu

Press the ESC key

- Display returns to first main menu.

Third main menu

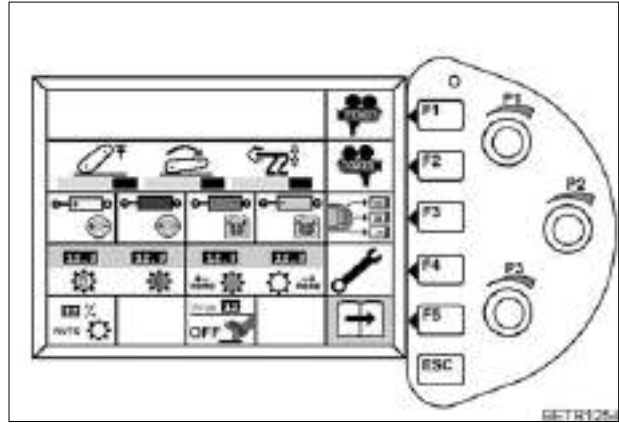

Fig.17

Pressing keys (F1 - F5) gives access to the following functions.

- F1 = Camera image (optional).
- F2 = Camera image mirrored (optional).
- F3 = Quick Jump
- F4 = Terminal settings
- F5 = Switch to first main menu

Settings can be made with the 3 rotary controls (P1, P2, P3) or a preset menu page (Quick Jump) can be selected.



The right rotary control for the settings is displayed in the Vario terminal.

Press the ESC key

- Display returns to first main menu.

Adjusting screen brightness and contrast

The brightness of the Vario terminal is automatically adjusted.

Dimming can be adjusted steplessly if necessary.

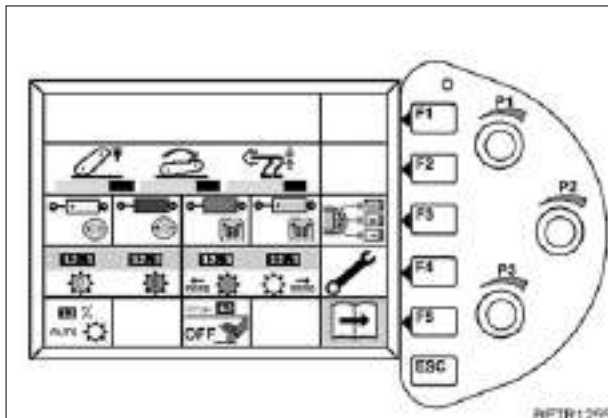

Fig.18

It is set in the third main menu

- Press key F4.

Following sub-menu for terminal settings appears.

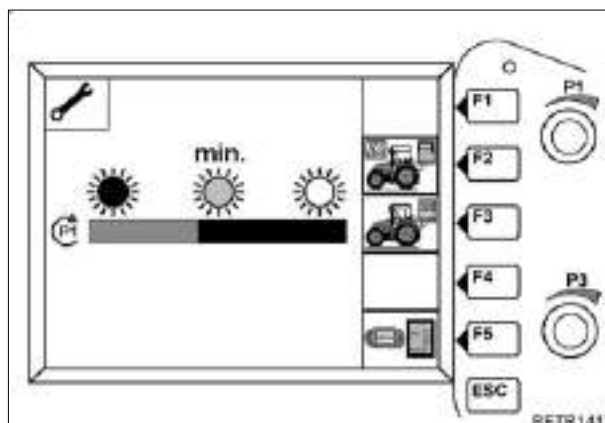

Fig.19

- Rotary control (P1) for setting degree of dimming.

Bar indicators:

right = no dimming.
left = max. dimming.

Any setting between the two positions is possible.

Pressing keys (F1 - F5) gives access to the following functions.

- F1 = No function.
- F2 = Service function (LBS-ISO) for the workshop.
- F3 = Service function for the workshop.
- F4 = No function.
- F5 = LBS-ISO (optional).

Press ESC key

- Display returns to first main menu.

OPERATION

2.14 Camera function

(optional).

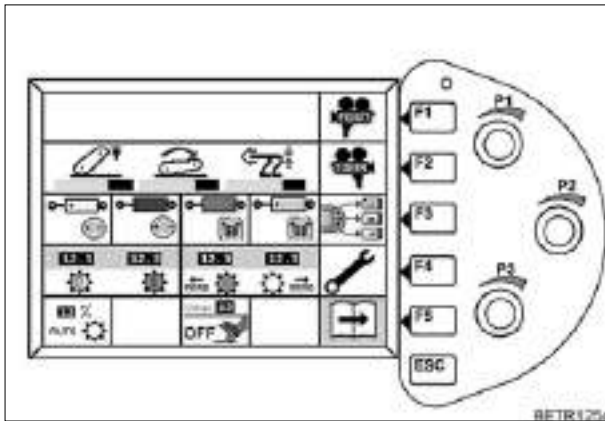

Fig.20

- Press the F1 or F2 key.

Following sub-menu for terminal settings appears.

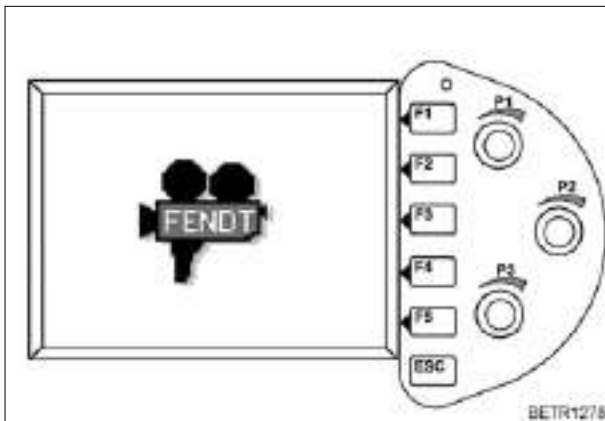

Fig.21

Press the ESC key twice.

- Toggles between main, implement and camera menus.

Setting brightness and contrast.

- Brightness can be set with the rotary control (P1).
- Contrast can be set with the rotary control (P2).

2.15 Quick Jump

This function allows a preset menu page to be selected directly from the first menu level. Turning the rotary control (P1 - P3) slightly, selects the preset menu page.

Press ESC key

- Display returns to first main menu.

Selecting menu pages

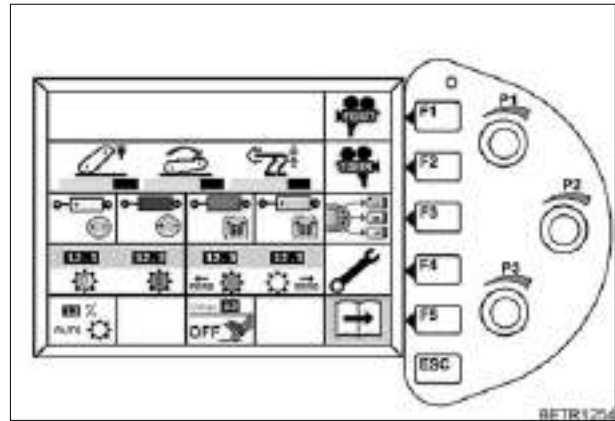

Fig.22

- Press F3 key.

Following sub-menu for terminal settings appears.

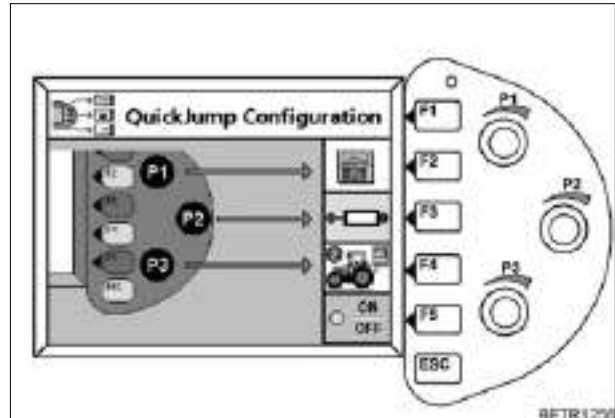

Fig.23

- Choose the desired menu page with the F2 - F4 keys.

Press key repeatedly until the desired menu page appears.

- Switch function on and off with the F5 key.
- LED lights up green - function is on.

Selection of the jump menu items

The jump menu items that can be selected, depend on the tractor equipment, e.g. if no front power lift is fitted, this jump menu item is not shown in the selection list.



Front power lift



Rear power lift



Rear power lift settings



Rear power lift settings, slip control



Overview of electrical valves

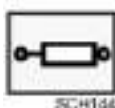

Electrical valves 1-4



Cruise control, load limit control



Quick reverse



Engine speed min. - max.



Fuel consumption indicator



On-board computer overview



On-board computer 1- 4



Load implement settings

Only possible if Teach In and the automatic modes for the power lift and PTO are not active.



Save implement settings

Only possible if Teach In and the automatic modes for the power lift and PTO are not active.



Implement control

Only possible if implement being installed.



Teach-in



Camera



Camera image mirrored



Terminal settings



Implement control diagnostics



Tractor diagnostics 1



Tractor diagnostics 2



TMS settings



Page with speeds

OPERATION

2.16 Cab top section, front

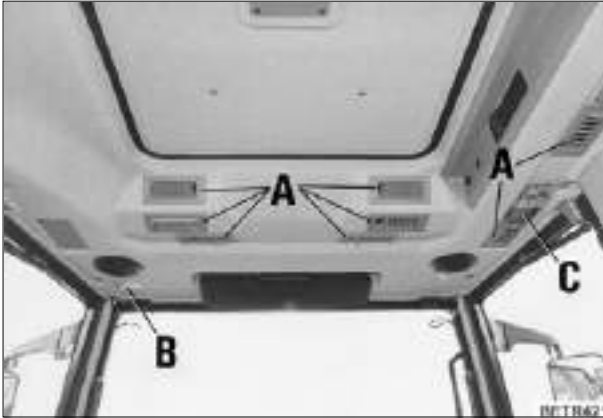

Fig.24

- A = Adjustable air nozzles
- B = Cab lighting
- C = Right-hand console lights

2.17 Cab top right side

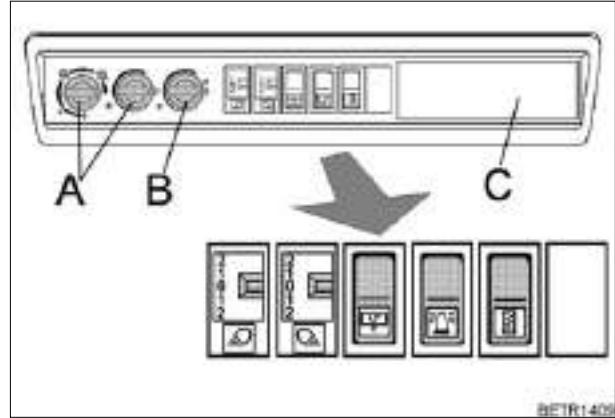

Fig.25

- A = Auxiliary ventilation (see also OPERATION Section 3.2).
- B = Air conditioning ON/OFF and temperature control switch (see also OPERATION Section 3.3).
- C = Space for radio installation, blanking panel. Connectors behind the panel are fitted as standard.



Work lamps at the front and at mirror brackets:

- 2 = front and at mirror bracket.
- 1 = front.
- 0 = off.
- 1 = on rear view mirror bracket.
- 2 = front and at mirror bracket.



Working lights at the rear and on mudguard:

- 2 = at rear and on mudguard.
- 1 = rear.
- 0 = off.
- 1 = on mudguard.
- 2 = at rear and on mudguard.



Rear window wiper and washing system.



Warning beacon.



Heated rear windshield.

2.18 Power outlets

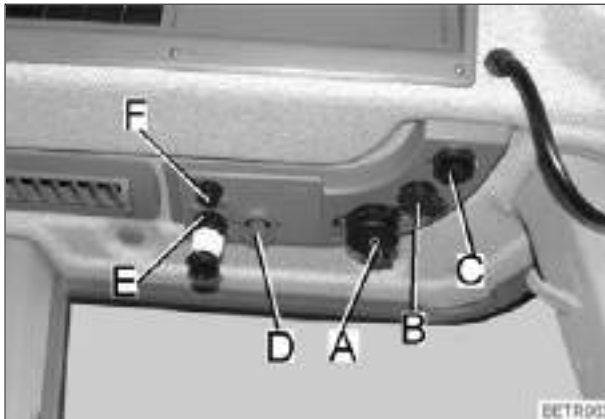

Fig.26

- A = 25 A constant current socket.
- B = 10 A socket.
- C = Implement socket.
- D = Socket (blue) for external pulse counter.
- E = LBS-ISO socket (optional) short circuit plug must remain in place due to feedback.
- F = Camera socket (optional).

Pin - attribution LBS-ISO implement socket cabin

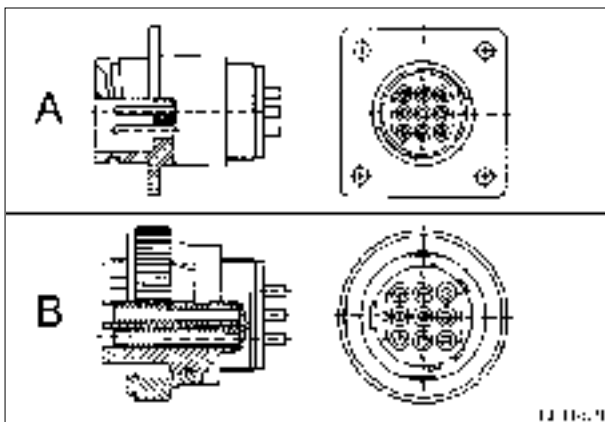

Fig.27

- A = Connector within cabin.
- B = Connector for LBS-ISO Terminal.
- Pin 1 = not used.
- Pin 2 = CAN Low input.
- Pin 3 = CAN Low output.
- Pin 4 = CAN High input.
- Pin 5 = CAN High output.
- Pin 6 = CAN-EN.
- Pin 7 = Power supply for connected implement (maximum load 5A).
- Pin 8 = CAN GND.
- Pin 9 = Ground connection for connected implement.

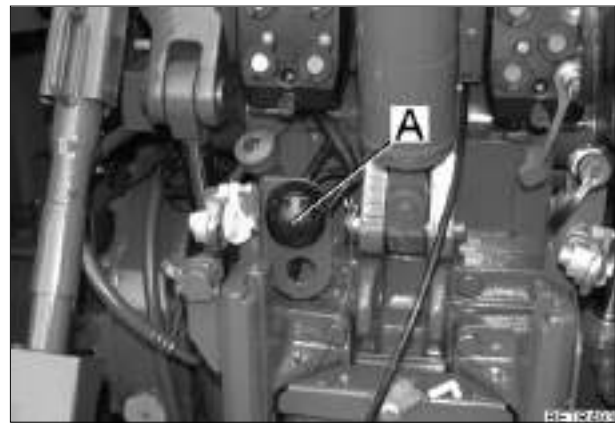

Fig.28

- A = Trailer socket.



Fig.29

- A = Electro-hydraulic external control: Socket for external sensor.

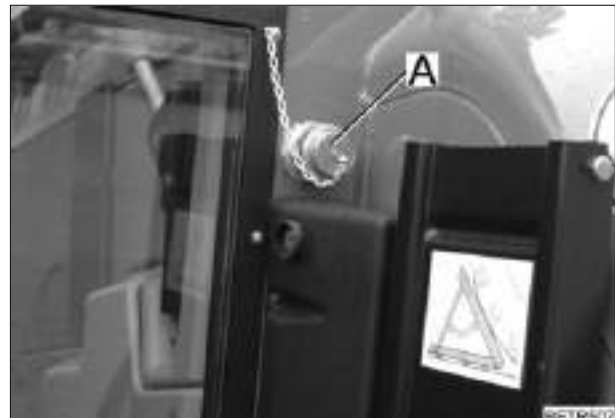

Fig.30

- LBS-ISO socket (A) rear (optional).

OPERATION

Pin - attribution LBS-ISO implement socket rear and front

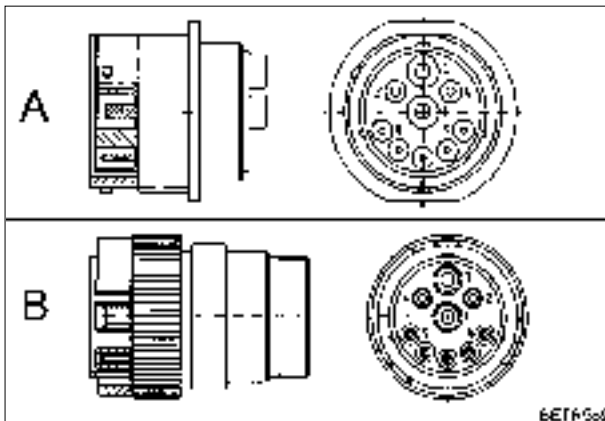

Fig.31

A = LBS-ISO socket for the mounted implement.
 B = LBS-ISO connector for the mounted implement.

Pin 1 = Earth 60A.

Pin 2 = Earth 25A.

Pin 3 = 60A power supply.

Pin 4 = 25A power supply for implement electronics.

Pin 5 = Control signal for switching the end system, bridged with pin 4 in the connector.

Pin 6 = CAN-EN.

Pin 7 = CAN GND.

Pin 8 = CAN High.

Pin 9 = CAN Low.

ABS socket (A)

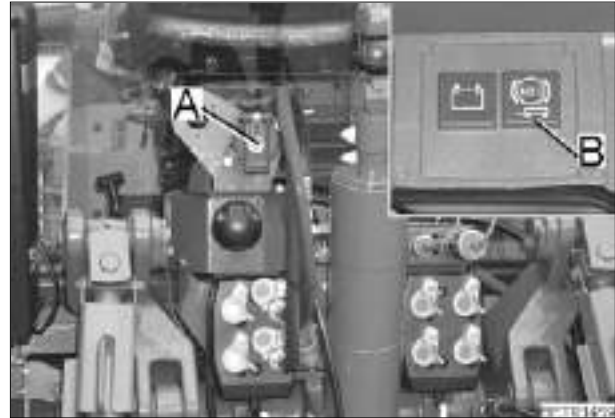

Fig.32

1 = + UB 30

2 = + UB 15

3 = Earth electronics

4 = Earth tractor body

5 = Indicator lamp

IMPORTANT:

When turning the ignition ON or OFF, the indicator lamp (B) in the instrument panel must light up briefly for monitoring purposes.



Fig.33

Socket (A) at front (with front power lift only).

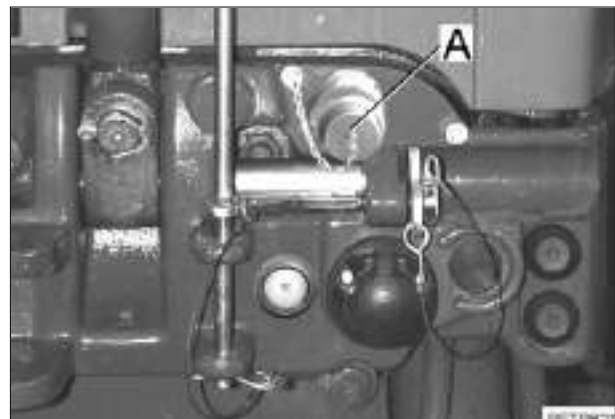

Fig.34

LBS-ISO socket (A) front (optional).

2.19 Reset function

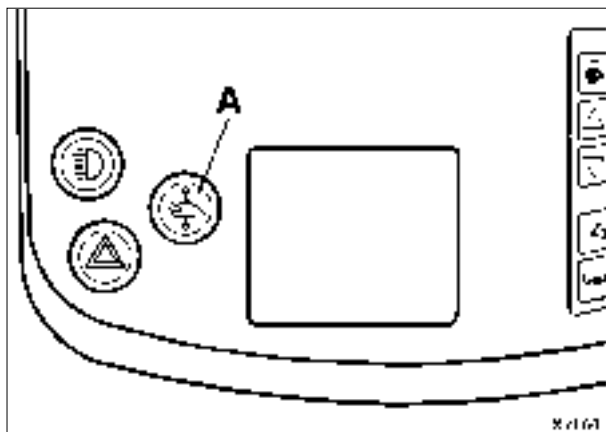

Fig.35

Reset - initiate function.

- Press clutch pedal.
- Press push button (A).

To end Reset function.

- Stop the tractor.
- Switch ignition OFF/ON.

When a reset is made, the following are restored to their basic settings.

- **Cruise control** (Memory 1 - final speed, Memory 2 - 10 km/h).
- **Load limit control** (14% reduction to rated speed).
- **Valves** (valid for all valves - lift 30 l, lower 30 l, time 10 seconds, floating position active).
- **Rear lifting gear** (upper limit 100% up, Traction/Position control 100% Position, lowering speed 50%).
- **Comfort front power lift** (upper limit of travel 100% up, lifting speed 30 l, lowering speed 5 l).

3. Heating and ventilation

3.1 Heater with 3-speed blower

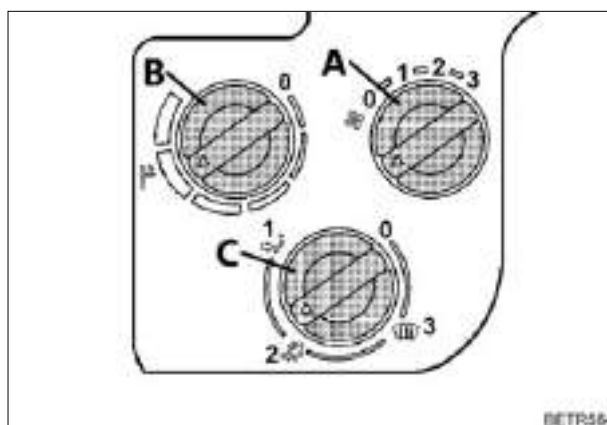





Fig.36

The heating depends on the water temperature.

Switch on fan (control knob A).

- 0** Fan off.
- 1** Fan speed 1.
- 2** Blower speed 2.
- 3** Blower speed 3.

Directing the air stream (control knob C).

- 0** Air outlet nozzles closed.
-  through air vents in the footwell.
-  through air vents in the footwell and in front of the windscreen.
-  through air outlet nozzles in front of windshield, recirculated air mode on at the same time.

Switching on the heater (control knob B).

The control knob is used to switch the cab heating on/off, and for stepless adjustment to the desired temperature.

NOTE:

If operating the air conditioning, set all control knobs to '0'.

OPERATION

3.2 Auxiliary ventilation in cab roof

CAUTION: When using the tractor for spraying operations (e.g. weed or pest control), fit filter cartridge (aerosols). Use only fan speed 1. After each spraying operation, replace the filter cartridge with a normal cartridge. Follow the instructions given with the filter. Cab and filter do not guarantee 100% protection against harmful chemicals. Follow the manufacturer's instructions!

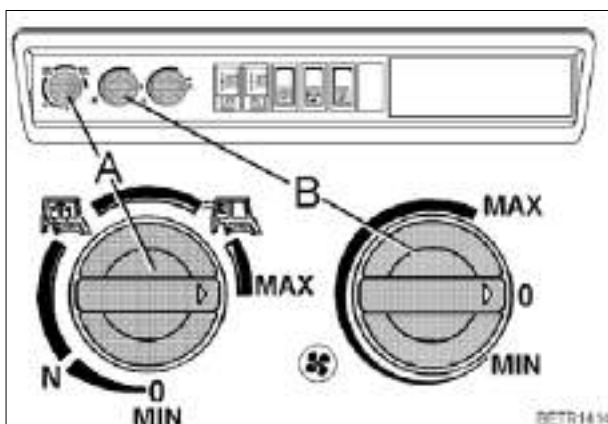

Fig.37

Recirculated air/fresh air (A)

MIN = 100% recirculated air - 0% fresh air.
MAX = 0% recirculated air - 100% fresh air.
N = Normal setting approx. 80% recirculated air - 20% fresh air.
0 = No fresh air.

The control knob position determines the mix between recirculated and fresh air.

Blower (B)

MIN = Minimum blower output.
MAX = Maximum blower output.
0 = Fan off.

Depending on the selector position, the blower output can be increased steplessly.

3.3 Air conditioning

WARNING: All repair and maintenance work must be carried out by qualified personnel only. Avoid all contact with liquid coolant. If accidentally splashed in the eyes, seek medical advice immediately. No welding should be carried out on or near any parts of the air conditioning systems! Risk of poisoning! Maximum ambient temperature for coolant 80 °C. Check the V-belt only while the engine is stopped. Attach the protective grille again.

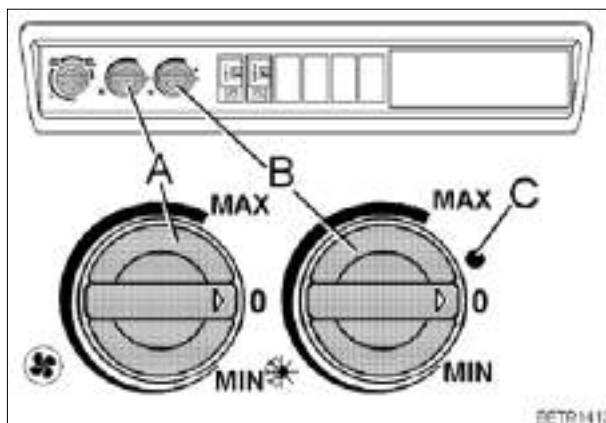

Fig.38

- Start engine tractor (air conditioning only works with the engine running).
- Switch on blower with selector (A).
- Switch on air conditioning with selector (B). Indicator lamp (C) shows that the system is working.

The air flow is controlled by and directed through nozzles (in cab roof cladding).

MIN = Minimum blower output, cooling power.
MAX = Maximum blower output, cooling power.
0 = Blower / air conditioning OFF.

Depending on the selector position, the blower output and cooling power can be increased steplessly.

NOTE:

For health reasons it is advisable not to allow the air inside the cab to drop by more than approx. 5 - 8 °C below the outside temperature. Do not expose yourself directly to cold draughts - danger of catching cold! For energy economy and greater efficiency, we recommend using the recirculated air mode.

4. Rearview mirror



CAUTION:
Before driving the tractor and starting work, adjust the mirror to guarantee a clear view of the road and of the working area to the rear.

Pull-out rearview mirror



Fig.39

- Adjust to tractor and/or trailer width using screw (arrowed).

5. Start-up

5.1 Daily check

Tractor must be in proper working condition.

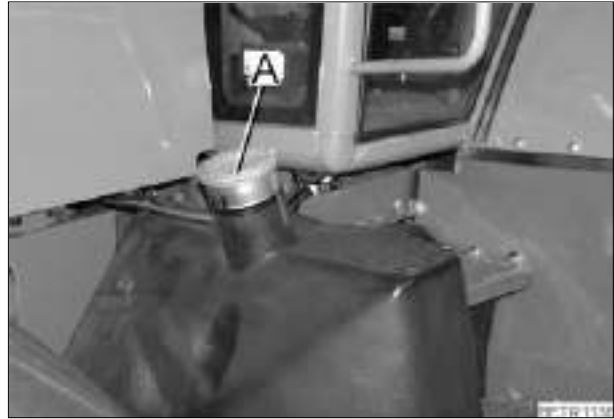

Fig.40

- Check fuel level. If necessary, top up through filler neck (A).

Top up with fuel after the day's operation to avoid build-up of condensation. If it has run dry, bleed the system.

- Check engine oil level (see also CARE AND MAINTENANCE Section 3.4).
- Check transmission oil level (see also CARE AND MAINTENANCE Section 10.2).
- Drain the water from compressed air bottle (see also OPERATION Section 22.1).

OPERATION

5.2 Cold weather operation

Keep battery well charged; fill with winter fuel. At temperatures below -12 °C, add flow improver or up to 30% petroleum.

Top up engine oil with HD-SAE 10W; Antifreeze in coolant 35 - 50 vol.-%.

Engine warmer

(optional).



Fig.41

- Connect engine warmer to mains supply (220 V) using the cable supplied.

Warming time at least 3 hours, depending on outside temperature. Preheating is only necessary in extreme cases.

Compressed air system

- Open the antifreeze pump (see also OPERATION Section 22.1).

5.3 Tool box



Fig.42

Removable tool box (A).

6. Starting and stopping the engine



DANGER:

Start the engine from the driver seat only. Never short circuit the battery. Never leave the engine running in a confined space!

Do not use priming fuel (e.g. Startpilot)!

6.1 Memory function

- Start tractor.
- The following image appears.

Tractor in neutral position (stationary)

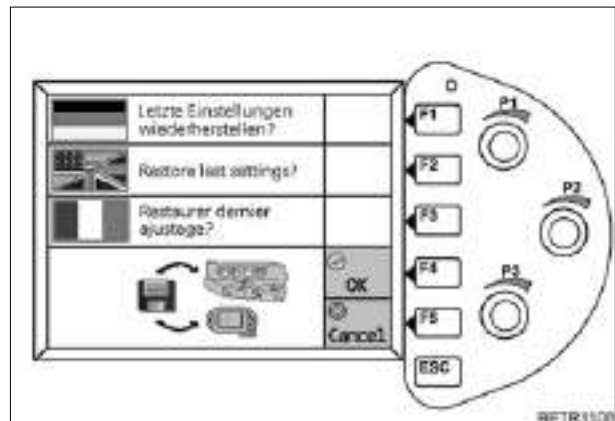

Fig.43

Key F4 = Activate selected settings (see OPERATION Section 28.1).

Key F5 = Activate the base settings.

If no key is activated, after about 10 seconds the tractor's base settings are activated.

Tractor in driving mode

If the tractor moves off immediately after it is started, the following picture appears.

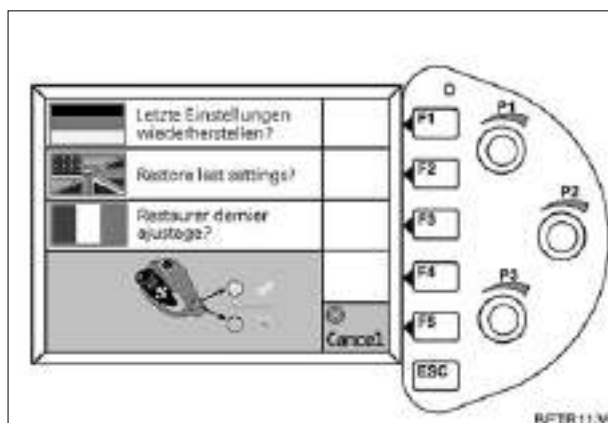

Fig.44

The selected settings (see OPERATION Section 28.1) can **not** be activated.

Key F5 = Main menu appears.

The main menu appears automatically after about 10 seconds.

or

The selected settings (see OPERATION Section 28.1) should be activated.

Bring tractor to a standstill and press the neutral button, further operation (see OPERATION Fig. 43).

6.2 Starting the engine

IMPORTANT:

Do not start or operate the tractor without a battery. This could destroy the alternator. Pay attention to warnings and fault messages. If necessary, switch off the engine immediately.

- Apply the hand brake.
- Depress clutch pedal (starting inhibit is deactivated).
- Switch off PTOs and other drives.
- Electrical operating Switch off all consumers if possible.

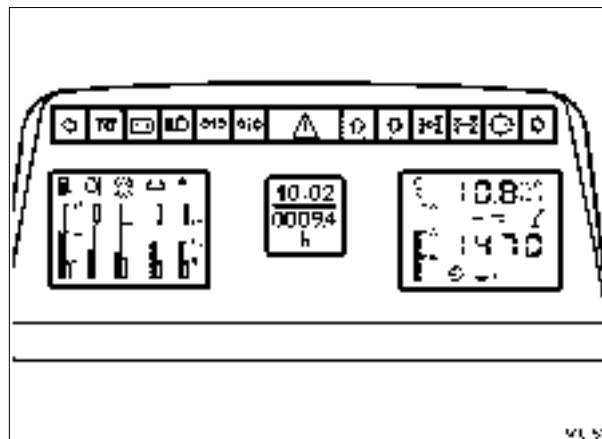



Fig.45

- Turn ignition key to position I, following symbols are illuminated:
- The LED neutral switch on the multi-function joystick.

 Charge indicator lamps.

 Driving direction indicators.

 Wait until preheat indicator flashes.

Steady light indicates preheating time.

- Turn ignition key to II and once the engine has started, move it back to I.
- Battery charge indicator lamps must go out.

NOTE:

If at very low temperatures the engine does not start within about 20 seconds, abort the starting procedure, allow the starter to cool down and wait for about 1 minute before trying again.

Switch off ignition before attempting to start again.

Allow starter to cool down. Do not operate the starter while the engine is still turning. In the event of repeatedly unsuccessful starting attempts, refer to 'FAULTS AND REMEDIAL ACTION'.

To avoid unnecessary white smoke, operate the tractor at 1,000 rpm maximum for up to 5 minutes (depending on temperature). (Can be driven with no load).

OPERATION

NOTE:

The flame start control unit detects faults in the flame starting system; these faults are indicated through various flash codes displayed on the preheating indicator (see **FAULTS AND REMEDIAL ACTIONS** Section 4.1).

6.3 Jump starting



WARNING:

A 24 Volt current destroys electronic components.

Do not allow contact between the non-insulated parts of the battery clamps. The jump lead connected to the positive terminal should not come into contact with any electrically conductive parts of the vehicle - danger of shorting!
To avoid sparks, always attach the jump lead clamps in the correct order.

Use jump leads to connect positive terminal to positive terminal and negative terminal to negative terminal of the assisting battery.

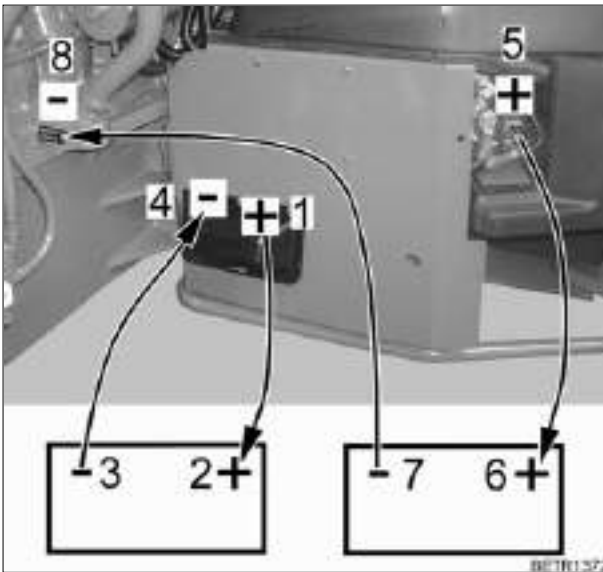

Fig.46

When battery partially discharged, jump starting from another tractor.

- Connect jump leads to the discharging tractor's battery in sequence (1-4).
- Start the engine of the second tractor.
- Start engine after ca. 15 minutes.
- Once the engine is running, disconnect the cables in reverse order.

Jump starting a partially discharged battery with another battery.

- Connect jump leads to the assisting battery in sequence (1-4).
- Start engine immediately.
- Once the engine is running, disconnect the cables in reverse order.

If the attempt is unsuccessful.

- Connect jump leads to two assisting batteries in sequence (1-8).
- Start engine immediately.
- Once the engine is running, disconnect the cables in reverse order.

NOTE:

Assisting batteries must have a voltage of 12 volts and around the same capacity (Ah) as the discharged batteries.

When jump starting, the engine must be started immediately after connecting, otherwise the assisting battery will become discharged as well.

Do not reverse the terminal polarity.

Use only jump leads with sufficient cross-section, and with insulated clamps.

Do not disconnect a discharged battery from the on-board electrical system.

If the tractor is left unused for an extended period, the battery can be recharged with a battery charger (12V).

6.4 Tow-starting

! WARNING:
Tow-starting is not possible!

6.5 Stopping the engine

- Turn ignition key to position 0.

NOTE:

After operating at full load, do not stop the engine immediately but allow it to cool down for about 2 minutes at about 1000 rpm.

6.6 Stopping and immobilising the tractor

! WARNING:
Before leaving the tractor, apply the hand brake, stop the engine, lower hydraulic implements to the ground and remove the ignition key. Make sure the tractor is secured to prevent it rolling. On slopes, chock the wheels. If the tractor is left on a public road, switch on the hazard warning lights and place the hazard warning triangle.

Hazard warning triangle



Fig.47

The hazard warning triangle (A) is attached behind the driver seat (hazard warning triangle not included as standard).

We would recommend ordering the warning triangle from:

GEKA GmbH Germany 73054 Eislingen / Fils
Schloßstraße 97

Tel. 0049 7161/99903-0

Fax 0049 7161/99903-99

7. Vario transmission

7.1 Joystick

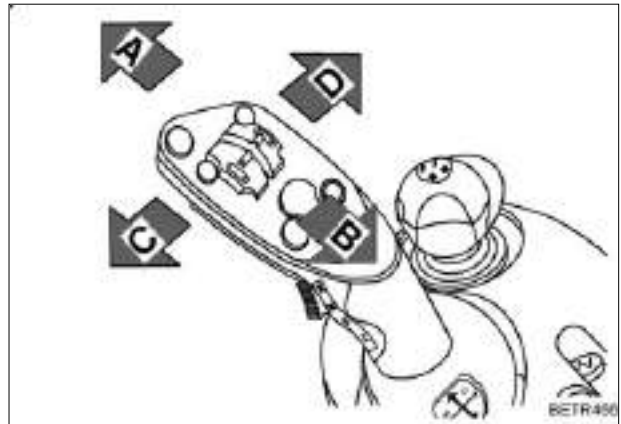

Fig.48

- A = Setting forward transmission ratio.
- B = Setting reverse transmission ratio.
- C = Change of direction of travel (forward/reverse using the joystick).
- D = Tempomat cruise control ON.

7.2 Neutral position

! WARNING:
Before leaving the tractor, make sure the transmission is set in neutral and engage parking brake.

If the engine is started or hand brake is applied, the transmission shifts to Neutral position.

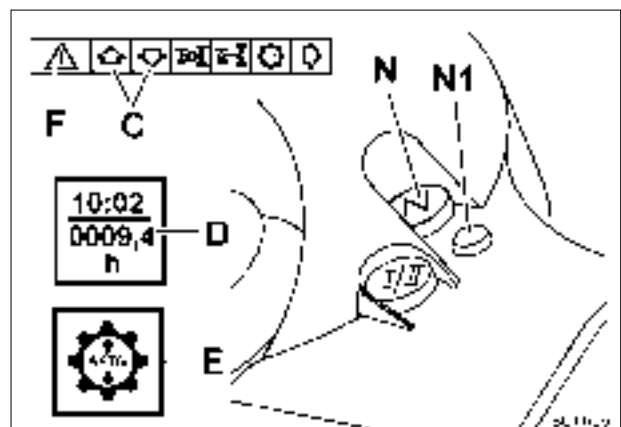

Fig.49

- The transmission is neutralised or activated with the neutral button (N).

Indicators with Neutral position selected.

1. LED (N1) lights up.
2. Travel direction indicator lamps (C) flash.
3. Clock and operating hours (D) indicators on the multiple display.

OPERATION

Indicators when Neutral position is disengaged.

1. LED (N1) is not lit.
2. Direction of travel indicator (C) are lit.
3. ACTIVE symbol indicator (E) on the multiple display.
4. Warning light (F) flashes.

7.3 Selecting acceleration rates

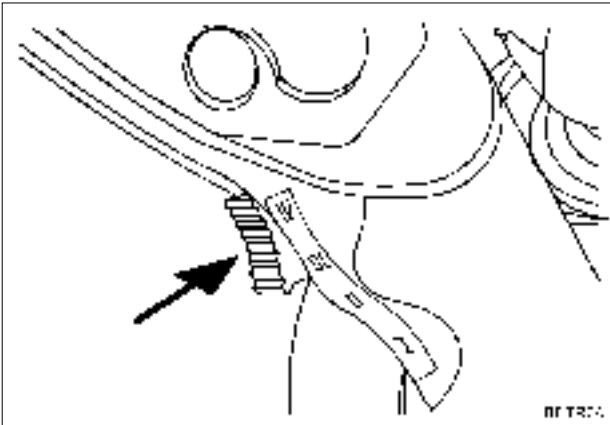

Fig.50

- Using the switch (arrowed), four different acceleration rates can be selected, even while moving.

With steady actuating of the joystick in one direction and at steady engine speed, driving speed increases slowest in Rate I and fastest in Rate IV.

In Rate I, the rate of change of speed can be set at between 0.02 km/h and 0.5 km/h using the keypad on the dashboard (at rated engine speed).

The following table shows the change of speed if the joystick is pressed once, and the time to reach maximum speed if the joystick is pressed steadily, for the 4 acceleration rates.

Rate	One push	0 to 50 km/h
I	0.02 - 0.5 km/h	250-45.5 secs
II	0.5 km/h	45.5 secs
III	1 km/h	23.8 secs
IV	2 km/h	10 secs

Values at engine rated speed.

NOTE:

When the cruise control is on, the time to reach the stored speed depends on the acceleration rate selected. Position I is not programmable.

Setting acceleration rate I

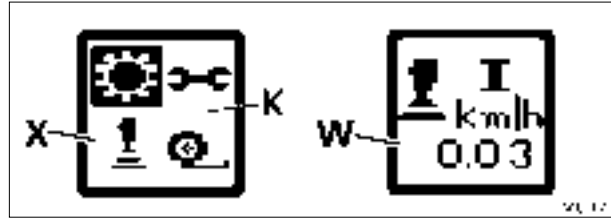

Fig.51

Procedure:

- Press key, graphic (K) is displayed.
- Press one of the keys repeatedly until symbol (X) flashes.
-
- Press key, graphic (W) is displayed, speed is indicated in km/h.
- Press one of keys repeatedly until the desired value is displayed.
- The indicated value is immediately effective, press ESC to store the value.
- Press key repeatedly until clock and operating hours are shown on the multiple display.

NOTE:

The acceleration rate cannot be set when neutral position is switched off.

Recommended use

- Rate I** = Use for specialist operations, e.g. road-milling machine.
- Rate II** = Use in field work, heavy traction work.
- Rate III** = Use in field work, heavy traction work.
- Rate IV** = Use for transport operations.

7.4 Driving mode selector



WARNING:
When selecting driving mode, tractive power is interrupted. Do not use on slopes (uphill or downhill).

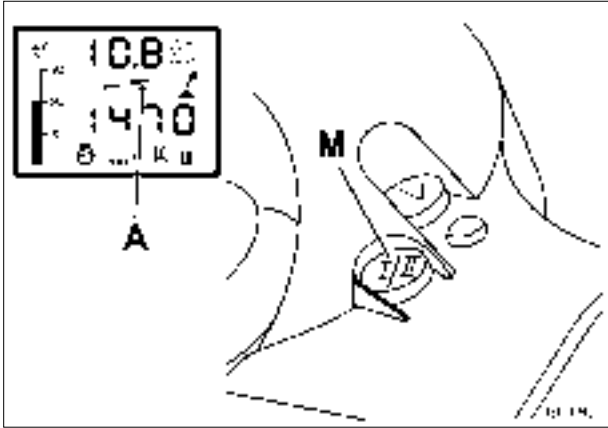

Fig.52

The currently selected mode is indicated by a spot (A). The selected mode is indicated by a flashing spot.

- The driver can use button (M) to switch from range I to range II.

NOTE:

The last range selected is always set, even after turning the ignition on or off.

RANGE I (field)

For heavy field use at a speed of:

0.02 - 32 km/h forward.

0.02 - 20 km/h in reverse.

RANGE II (road)

For fast transport at speeds of:

0.02 - 50 km/h forward.

0.02 - 38 km/h in reverse.

Switching when tractor stationary

- Select Neutral position or
- operate clutch pedal.
- Select the desired mode.

Selecting driving mode I or II while travelling

Driving mode selection is not possible if:

- Neutral position is engaged.
- Transmission oil temperature below 10°C.
- Engine brake actuated.

Switching from operating range II to I when travelling

Driving mode selection is not possible if:

- Ground speed over 20 km/h.
- Neutral position is engaged.
- Engine speed over 2300 rpm.
- Transmission oil temperature below 10°C.
- Engine brake actuated.

NOTE:

In unfavourable conditions, e.g. cold weather, selecting a driving mode may simply cause the neutral position to be selected. Interruption of tractive power, repeat driving mode selection with button (M/ OPERATION Fig. 52).

Cruise control and Quick Reverse function deactivated.

OPERATION

7.5 Driving the tractor



WARNING:

Always engage the gears when travelling downhill. Do not select neutral.

At engine speeds over 2600 rpm, the transmission ratio is no longer reduced; to reduce speed, apply the brake.

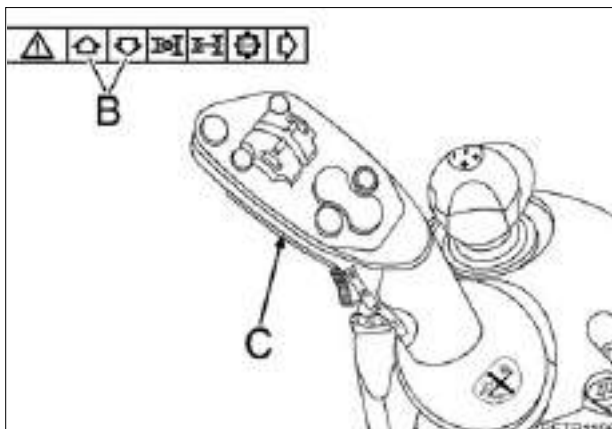

Fig.53

Starting off forward from a standstill:

- Press and hold the activating button (C, on back of joystick).
- If the joystick is moved forward, the tractor moves off and accelerates forward.
- If the joystick is released, it automatically returns to center position and speed remains constant.
- If the joystick is pulled back, the tractor slows down and braking is applied until it comes to an actuated standstill.

Reversing from a standstill:

- Press and hold the activating button (C, on back of joystick).
- If the joystick is pulled back, the tractor will move off in reverse and accelerate.
- If the joystick is released, it automatically returns to center position and speed remains constant.
- If the joystick is moved forward while reversing, the tractor slows down and is positively braked until it comes to a standstill.

NOTE:

It is also possible to operate the joystick first, then press the activating button afterwards.

NOTE:

Optionally, a warning beep sounds when driving in reverse.

Turboclutch

The transmission control includes a turboclutch function. This allows the tractor to be stopped with the accelerator pedal.

This means:

1. No engine stalling under difficult conditions.
2. No wheel spinning.
3. Full power transmission from approx. 1,250 rpm engine speed.

Deactivating turboclutch function

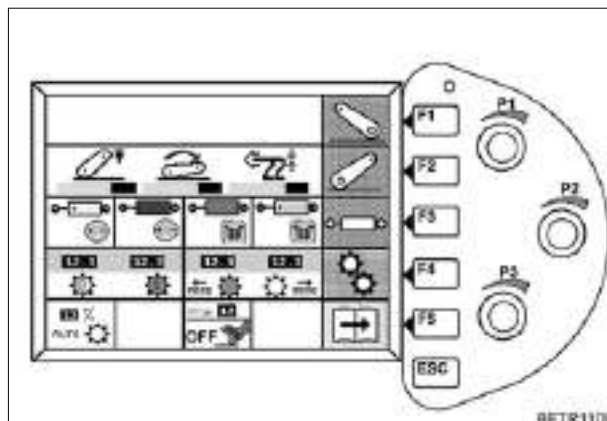

Fig.54

- Press key (F4). The following sub-menu appears.

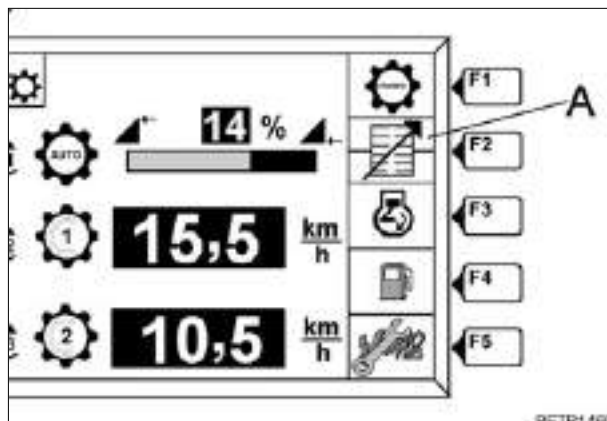

Fig.55

Required conditions:

1. Engine is running.
2. No current fault messages.
3. Transmission in neutral.
4. System not in emergency operation.

- Pressing key (F2) switches turboclutch function on and off.

When the function is on, symbol (A) appears as shown, when the function is off, the symbol is shown with a red cross superimposed.

After every cold start, the turboclutch function is automatically activated again.

Driving off using the turboclutch function

- Setting the engine idle speed.
- Apply the brake.
- Press activating button and use the joystick to select the desired direction of travel.
- Release the brake and start off by accelerating slightly.
- Use the joystick to obtain the desired ground speed.

NOTE:

Avoid stopping for long periods (>1 min.) with the turboclutch on.

When operating with sustained load, do not allow the engine speed to drop below 1,250 rpm.

Do not operate the clutch pedal for long periods.

Stopping and starting on slopes

- Move joystick against the actual travel direction.

The tractor slows down until it comes to a standstill. 'Active' symbol flashes.

NOTE:

Below an engine speed of 1,250 rpm, depending on load, turbo clutch function will allow transmission slip.

Clutch pedal

For connecting implements, the tractor can be controlled for gradual movements with the clutch pedal.

In sudden emergencies, the tractor can be stopped by pressing the clutch and brake pedals.

Final speed control

Final speed is a cruise control function which compensates for variations in engine speed.

T	E	A
about 33 km/h	32.5 km/h	31 km/h
about 44 km/h	43.5 km/h	42 km/h
about 51 km/h	50.5 km/h	49 km/h

T = Theoretical final speed

E = Switch-on speed

A = Cut-out speed

The speed control is terminated by operating any of the following:

1. Joystick
2. Brake pedals (including independent wheel brake)
3. Engine brake pedal
4. Clutch pedal

OPERATION

7.6 Changing direction of travel

The tractor slows to a standstill, then accelerates in the desired direction until the previous transmission ratio is reached.

The change of direction may be activated by:

- with the button on the steering wheel adjustment.
- with the joystick.

Direction changing is cancelled when the following are operated:

1. Joystick.
2. Neutral button.

The following factors will block the function, but not terminate it:

1. Load limit control.
2. Final speed limit.
3. Engine speed above 2,600 rpm.
4. Turboclutch function.

IMPORTANT:

An incomplete Quick Reverse operation is indicated by flashing direction of travel indicators. The selected change of direction is activated as soon as the problem is solved.

NOTE:

According to the selected acceleration rate, the reverse will be executed more or less rapidly.

Change of direction of travel using button on the steering wheel lever

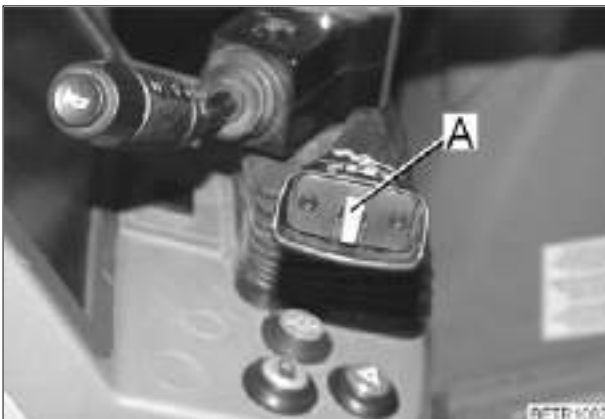

Fig.56

- Move the button (A) forwards or backwards.

The tractor slows down to a standstill and accelerates in the opposite direction until it reaches the previous transmission ratio.

- Keep the button (A) pressed forwards or backwards.

The tractor slows to a standstill. When the button (A) is released, the tractor continues in the previous travel direction and with the previous transmission ratio.

Changing the direction of travel using the joystick

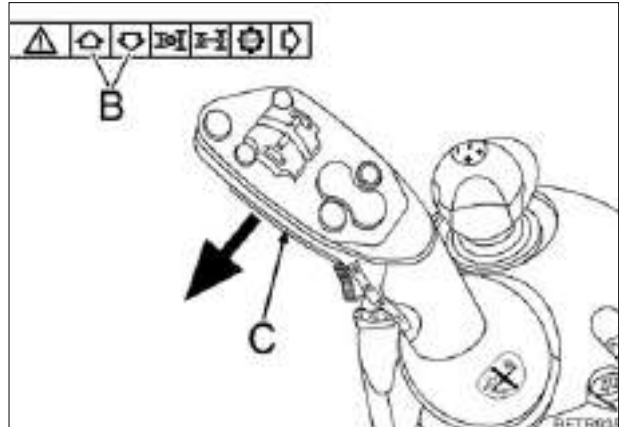

Fig.57

- Press and hold the activating button (C, on back of joystick). While the tractor is moving, push the joystick to the left.

If no change of travel direction has been programmed (see also OPERATION Section 7.7), the tractor slows to a stop and accelerates in the other direction of travel until it reaches the transmission ratio that was active in the initial direction.

While the tractor is slowing, the preselected direction of travel is shown by flashing of the corresponding indicator (B), and the current travel direction by a steady light.

NOTE:

Optionally, a warning beep sounds when driving in reverse.

7.7 Programmed changes of travel direction

NOTE:

The set values are only reached at an engine speed of 1800 rpm.

Using the control terminal, a forward speed and a reverse speed can be pre-programmed.

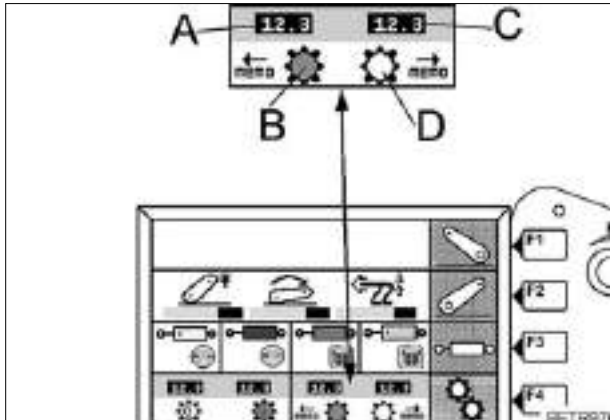

Fig.58

Set values are shown on the display (A / C).

Function display (B / D).

Indicator **red**, speed programmed for change in direction of travel.

Indicator **white**, speed not programmed for change in direction of travel.

- Press key (F4). The following sub-menu appears.

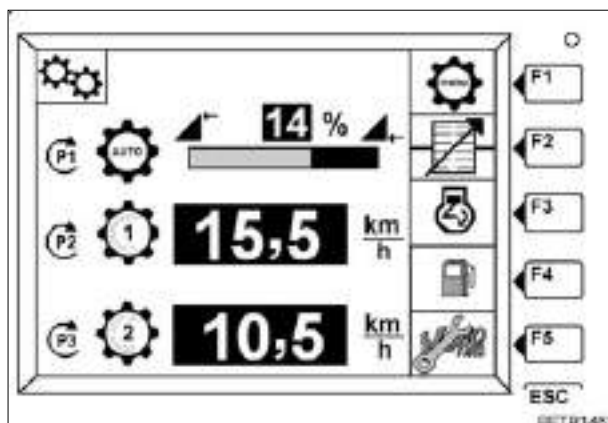

Fig.59

- Press key (F1). The following submenu appears.

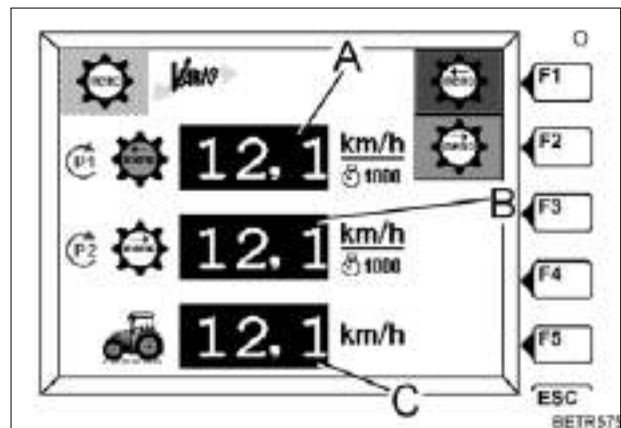

Fig.60

The set speeds are indicated by the indicators (A and B).

(C) shows actual speed; below 0.5 km/h, the values change from **km/h** to **m/h**.

Indicator from 100 m/h to 500 m/h.

Setting speeds

- Select forward speed with rotary switch (P1).
- Select reverse speed with rotary switch (P2).

Activating the selected speed

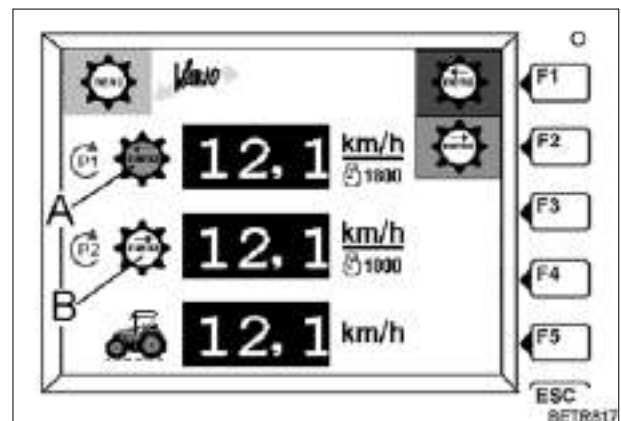

Fig.61

Activating stored forward speed

- Press key (F1).
- Display (A) changes from **white** to **red**.

Activating stored reverse speed

- Press key (F2).
- Indicator (B) changes from **white** to **red**.

Function indicator also appears on the first main menu (see OPERATION Fig. 58).

OPERATION

Actuating the stored speed

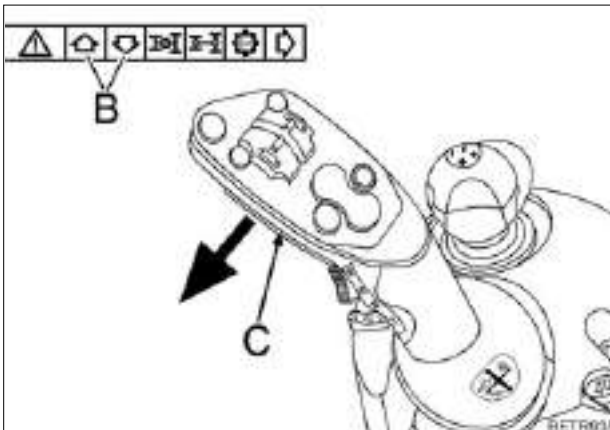

Fig.62

NOTE:

The set values are only reached at an engine speed of 1800 rpm.

- With the vehicle moving, push the activating button (C) and move joystick to the left (towards the driver seat).

NOTE:

If a direction change has been programmed, the tractor slows to a stop and accelerates in the opposite direction until it reaches the programmed transmission ratio.

NOTE:

Optionally, a warning beep sounds when driving in reverse.

7.8 Cruise control

NOTE:

Tempomat cruise control only possible at an engine speed above 1,300 rpm.

With cruise control, current speed is maintained without storing.

In addition, two speeds can be stored to allow the tractor system to be configured for two different situations, such as field work and road travel.

Once stored, the cruise control actuates one of the stored speeds.

The stored speed is reached within a time that depends on the acceleration rate selected (see also OPERATION Section 7.3).

Maintaining current speed

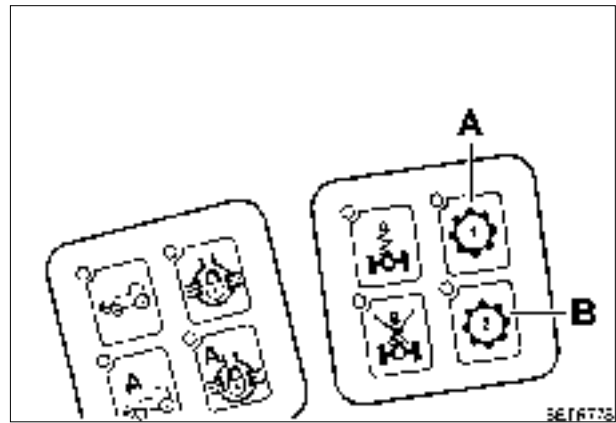

Fig.63

NOTE:

No speed must be stored via one of the keys (A or B).

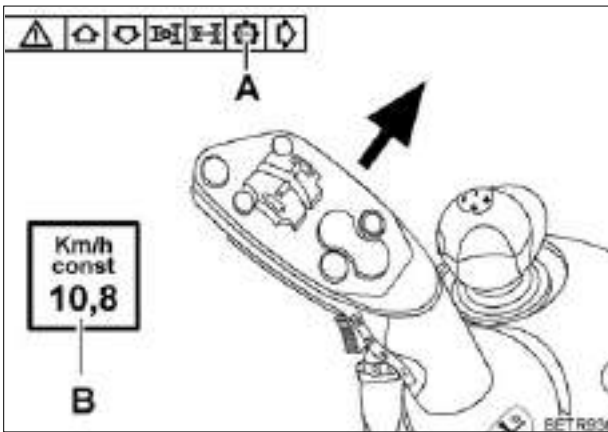

Fig.64

- Accelerate to the desired speed.
- Move the joystick briefly to the right (away from driver seat).

Indicator lamp (A) is lit, speed is displayed for 3 seconds on the multiple display (B).

Current speed now remains constant, irrespective of engine speed.

Storing speeds

The stored speeds are maintained even after the ignition is switched off.

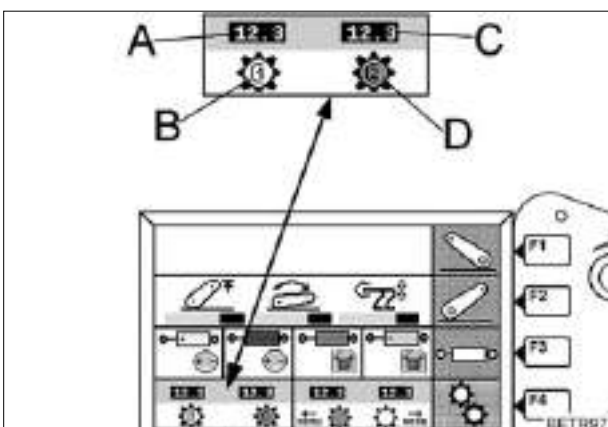

Fig.65

Set values are shown on the display (A / C).

Function display (B / D).

Indicator **violet**, speed programmed for cruise control.

Indicator **white**, speed not programmed for cruise control.

- Press key (F4). The following sub-menu appears.

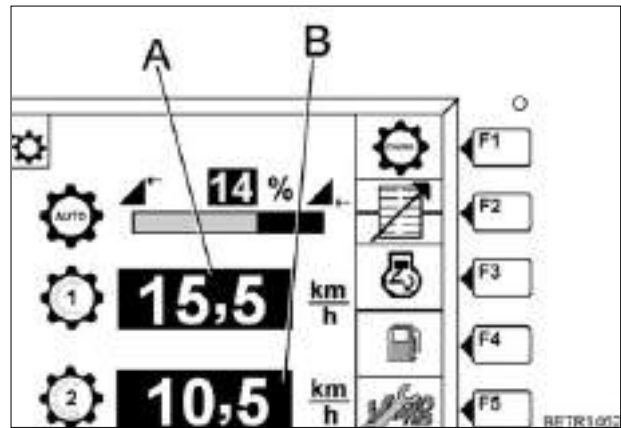

Fig.66

Stored speeds are shown on the displays (A and B).

- Turn rotary switch (P2) to set speed in memory 1 (indicator A).
- Turn rotary switch (P3) to set speed in memory 2 (indicator B).

Selecting speeds

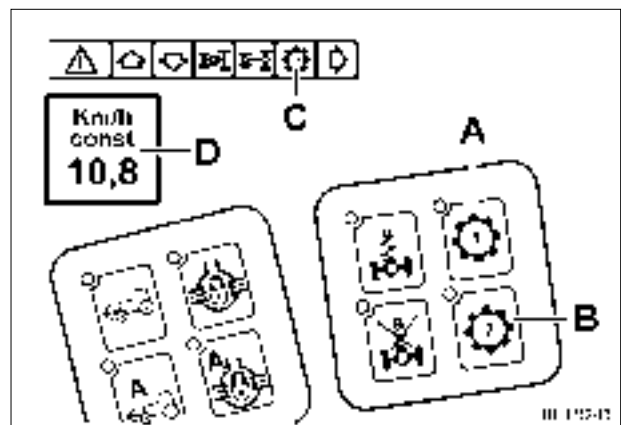

Fig.67

Pre-selecting when Tempomat cruise control is not activated.

- Briefly press key (A) (Memory 1) or key (B) (Memory 2).

The corresponding LED next to the key lights up.

Depending on preselection, indicator 1 or 2 is lit violet (see OPERATION Fig. 66).

Depending on preselection, indicator B or D is lit violet (see OPERATION Fig. 65).

A pre-selected speed can be cancelled by re-activating the respective key.

OPERATION

Actuating the preselected speed

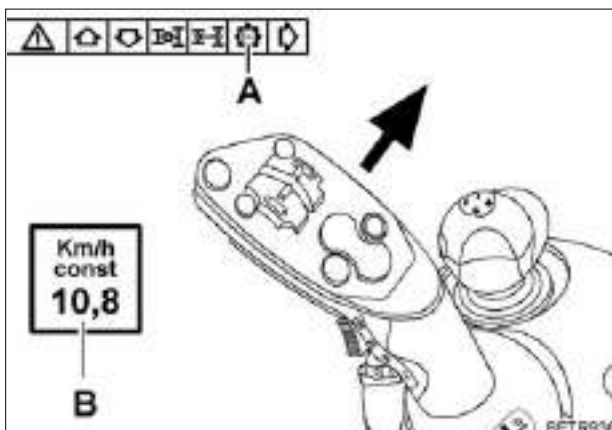

Fig.68

- While the tractor is moving, move the joystick briefly to the right (away from driver seat).

Depending on preselection, indicator 1 or 2 is lit green (see OPERATION Fig. 66).

Depending on preselection, indicator B or D is lit green (see OPERATION Fig. 65).

Memorised selected speed is activated and remains constant independent of the engine speed.

By adjusting the stored speed with the appropriate rotary control, Tempomat cruise control speed can be adjusted to operating conditions.

When operating the other memory button (OPERATION Fig. 67/A,B), the cruise control adjusts to the new target speed.

Indicator lamp (A / see OPERATION Fig. 68) is lit, speed is indicated on the multiple display (B / see OPERATION Fig. 68) for 3 seconds.

NOTE:

Memorised speeds can only be activated while the tractor is moving.

The stored speed can be actuated in both driving modes and both directions of travel. If the selected speed is not reached, check the setting for the load limit control.

Cruise control function remains active until one of the following occurs:

1. clutch pedal is depressed.
2. brake pedal is depressed (also individual wheel brake).
3. joystick is activated.
4. neutral key is activated.
5. engine brake is activated.
6. engine speed falls below 1,300 rpm.
7. a driving mode is selected.

7.9 Load limit control

The load limit control is activated automatically if engine speed drops under load. To do this, the tractor automatically uses the transmission control to reduce the vehicle speed so that engine speed does not drop any further.

Setting load limit control

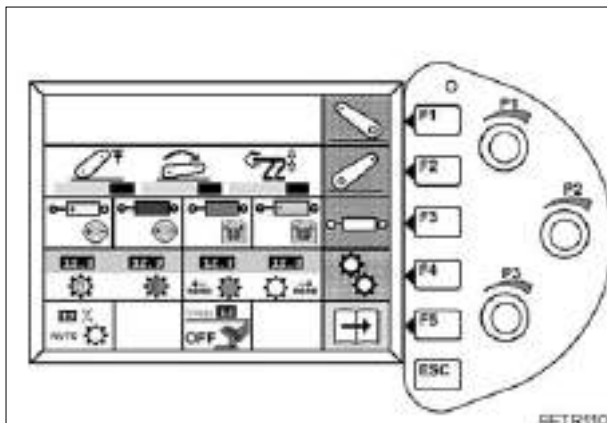

Fig.69

- Press key (F4). The following sub-menu appears.

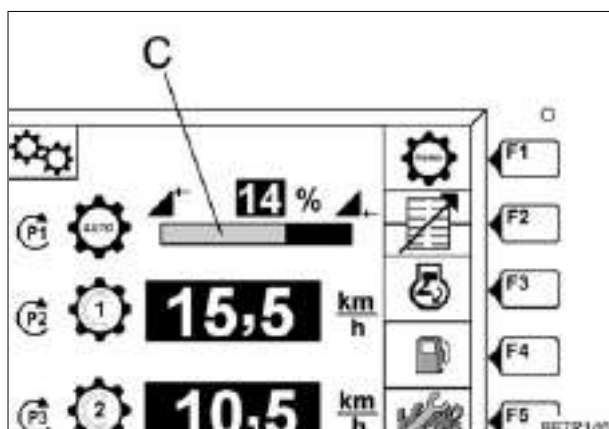

Fig.70

The set engine load limit is displayed by the bar indicator (C), e.g. 14 %.

- The rotary control (P1) can be used to set engine load between 0 % - 30 %.

The setting is effective immediately. In this way, the tractor can be adapted to the current situation during operation.

The load limit control only changes the transmission ratio to slower. Re-accelerating, once the engine speed rises again, can either be done manually using the joystick or automatically with the cruise control function.

7.10 Storing engine speeds

Two engine speeds can be stored using rotary controls (P1/P2) on the Vario terminal.

e.g. **Speed 1** working speed - full throttle.

e.g. **Speed 2** standing speed - idle.

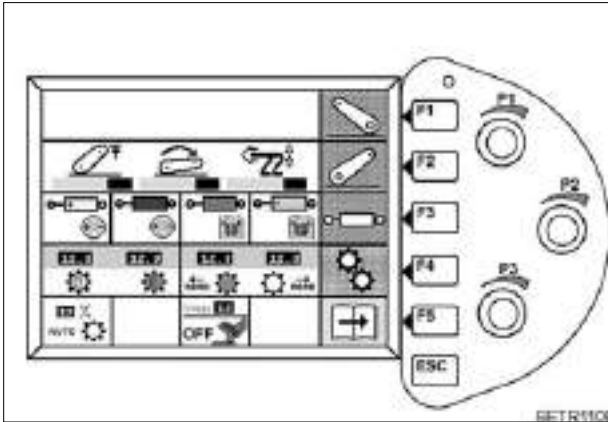

Fig.71

- Press key (F4). The following sub-menu appears.

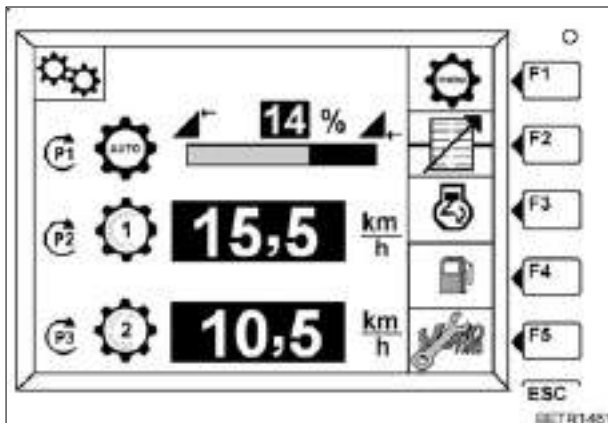

Fig.72

- Press key (F3). The following submenu appears.

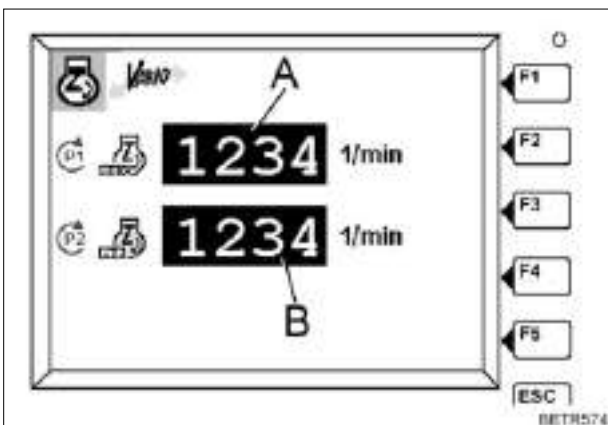

Fig.73

- Set engine speed 1 in Memory 1 (display A) with rotary control (P1).
- Set engine speed in Memory 2 (indicator B) with rotary switch (P2).

Stored engine speeds are indicated on the displays (A and B).

NOTE:

The maximum engine speed that can be set is the engine limit speed.

The minimum engine speed that can be set is the idle speed.

The value set can be exceeded with the accelerator.

Read the stored engine speed

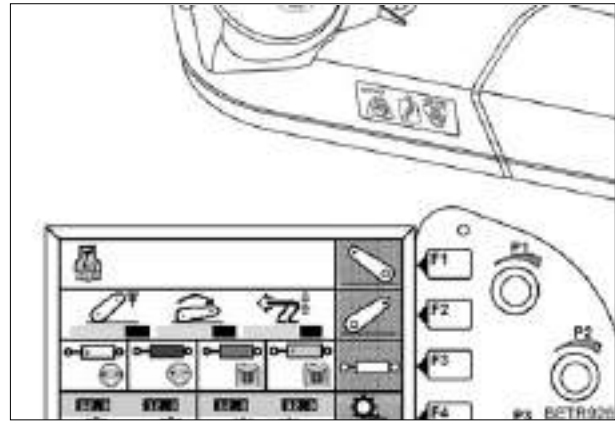

Fig.74

MAX Read the stored higher engine speed (e.g. working speed - full throttle). LED is lit.



ACT Activating engine management (see OPERATION Section 9).



MIN Reading out the lower stored engine speed (e.g. headland speed - idle). LED is lit.



OPERATION

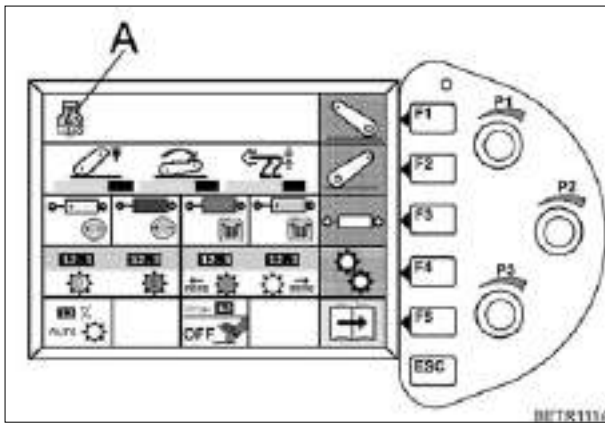

Fig.75

- Indicator (A) appears on the Vario terminal, indicating active stored engine speed.

Engine speed storing is terminated if one of following conditions is present.

1. Speed over 18 km/h and foot brake is operated.
2. Speed over 18 km/h and engine brake is operated.
3. Call-up buttons are activated again.
4. Hand throttle is operated.

7.11 Towing instructions



Fig.76

- Open cover from the cab floor and remove.
- Attach auxiliary device to range control switch (C).
- Put transmission into neutral position (centre position).

NOTE:

**Do not exceed a towing speed of 10 km/h.
Maximum towing distance 8 km.**

8. Fuel consumption measurement

(also refer to OPERATION Section 27.4).

8.1 Activating fuel consumption measurement

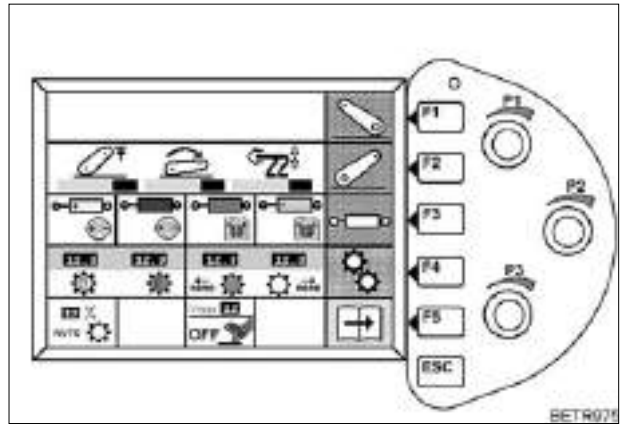

Fig.77

- Press key (F4). The following sub-menu appears.

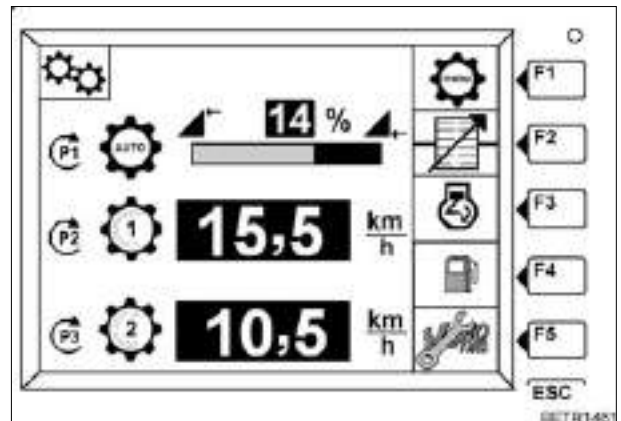

Fig.78

- Press key (F4). The following sub-menu appears.

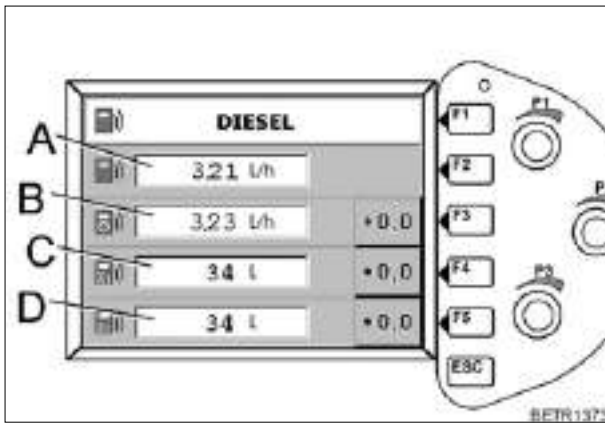

Fig.79

- A = Current fuel consumption.
 B = Average fuel consumption.
 Measurement at tractor START or Press button (F3). Display is reset to '0'.
 C = 1. Unit counter (e.g. for comparing the same operation when different driving styles are used).
 Measurement at tractor START or Press key (F4). Display is reset to '0'.
 D = 2nd sum counter (e.g. comparisons of the same work done with different driving methods).
 Measurement at tractor START or Press key (F5). Display is reset to '0'.

NOTE:

Maximum value for the sum counter is 30000 litres, then measuring starts at 0 again.

9. Tractor Management System (TMS)

MODE 1**Joystick - engine management system off**

The transmission ratio is set with the joystick, the engine speed is set with the accelerator.

MODE 2**Joystick - engine management system on**

Driving speed is set with the joystick; the engine speed and transmission ratio are set automatically.

NOTE:

If the TMS is active and change of direction is programmed, the speed is taken up independent of the engine speed.

MODE 3**Accelerator - engine management system off**

The transmission ratio and the engine speed are set with the accelerator.

MODE 4**Accelerator - engine management system on**

Driving speed is set with the accelerator; the engine speed and transmission ratio are set automatically.

NOTE:

If TMS is active and there is a programmed change of travel direction, only the current speed is obtained.

OPERATION

9.1 Engine management system



CAUTION:

If engine management is active, the engine speed can increase to maximum engine speed.

NOTE:

Engine speeds settings made with the hand throttle potentiometer can be exceeded, but speed will not go below the set speed.

NOTE:

If the TMS is active, the Tempomat cruise control function has no engine speed limit (e.g. the Tempomat cruise control can even be activated at idling speed).

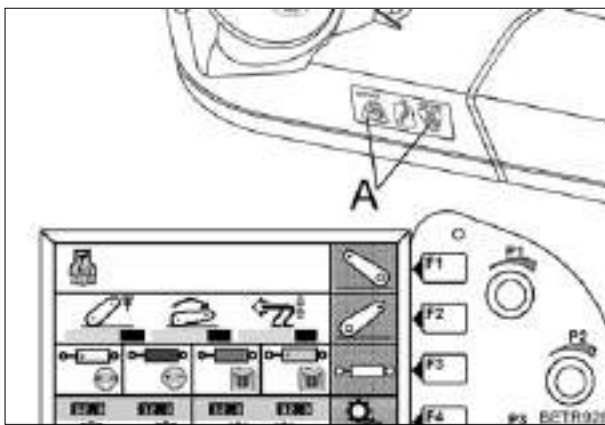

Fig.80

NOTE:

If stored engine speeds are activated using the memory keys (A), the speed will not exceed or fall below the set speeds, even with the engine management system engaged (e.g. when working with the PTO).

Switching on the engine management system

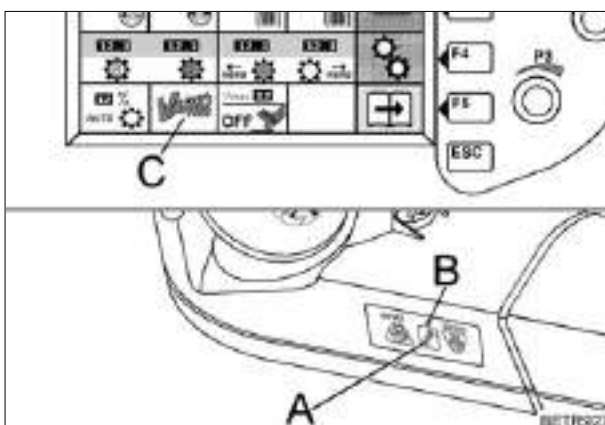

Fig.81

- Press button (A).
- LED (B) is lit.
- Indicator (C) appears.

When the desired ground speed is reached, engine speed is reduced as far as possible.

9.2 Accelerator mode

Activating the accelerator pedal function

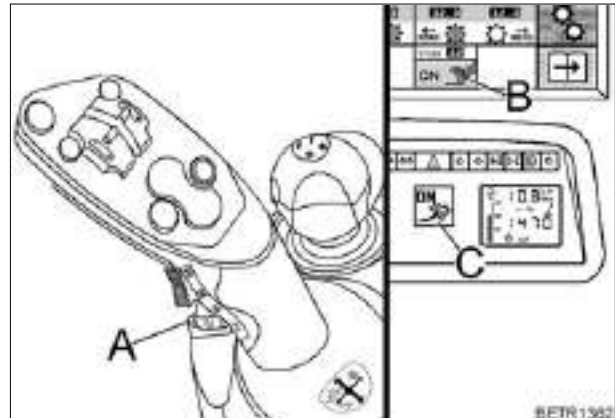

Fig.82

- Press button (A) forward.

B = Indicator appears on the Vario terminal.
C = Indicator appears on the multiple display.

NOTE:

When the accelerator function is engaged, the Tractor Management System (TMS) is switched on in the basic setting.

Switching off the accelerator function

- Press key (A) backwards.

Function displays

On the multiple display.



FEHL77

Appears for about 2 seconds when accelerator pedal mode is active or as long as no direction of travel is selected.



FEHL76

Appears for about 2 seconds when accelerator pedal mode is switched off.



FEHL75

Appears when the joystick is moved in the current direction of travel in accelerator mode. At the same time a warning beep sounds.

Accelerating with the joystick is not possible.

Selecting direction of travel

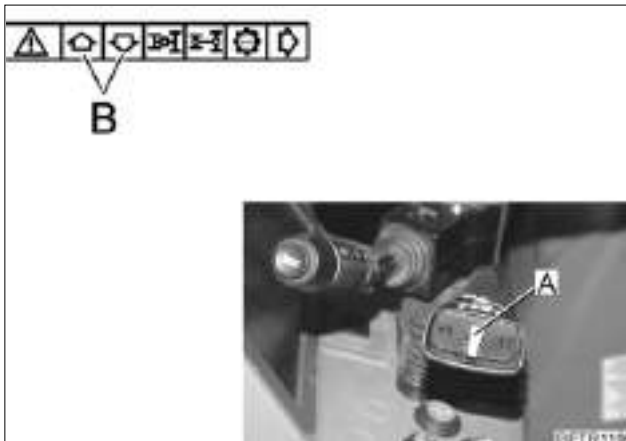

Fig.83

- Select direction of travel with switch (A).
- Selected direction indicator (B) flashes.
- Start off with the accelerator pedal.
- Selected travel direction indicator (B) is lit.

NOTE:

Once the direction of travel has been activated, the direction of travel can also be changed by moving the joystick to the left with the activating button pressed.

On the driver seat is a start-off protection. If the driver's seat is unoccupied for more than 3 seconds when the tractor is stationary, the pull-away cutout is activated. The travel direction indicators (B) flash. The direction of travel must be reselected.

Cancelling accelerator

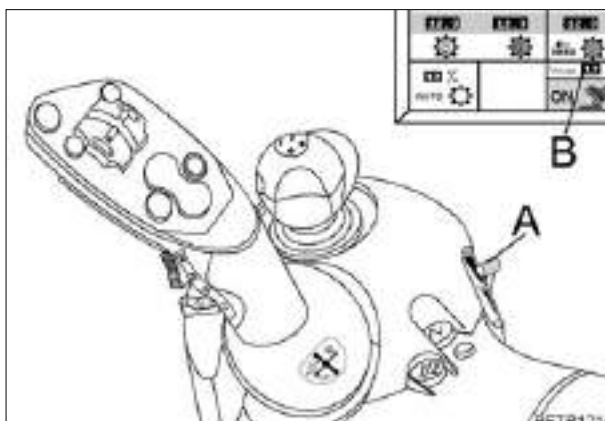

Fig.84

By using lever (A) the 'maximum' speed can be changed.

Display (B) on the Vario terminal shows the speed, which is reached with the accelerator fully depressed.

Decelerating with the joystick

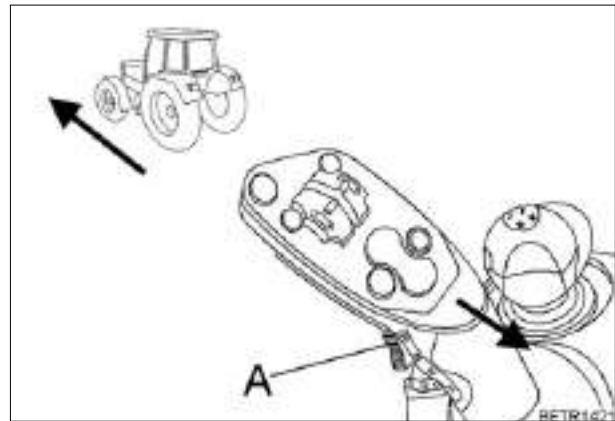

Fig.85

In accelerator pedal mode, the tractor can also be slowed down with the joystick.

Move the joystick in the direction opposite to the current direction of travel.

Deceleration (I slower - IV faster) can be influenced with the acceleration switch (A).

9.3 Setting engine speed range

When working with TMS, it can be advantageous to set the upper and lower limits for the engine speed control range (target speed).

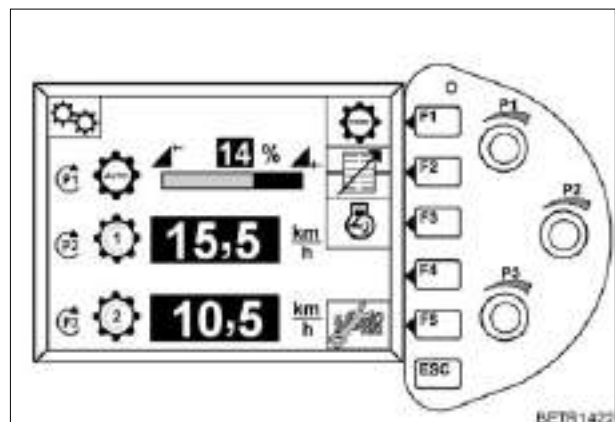

Fig.86

- Press key (F5). The following sub-menu appears.

OPERATION

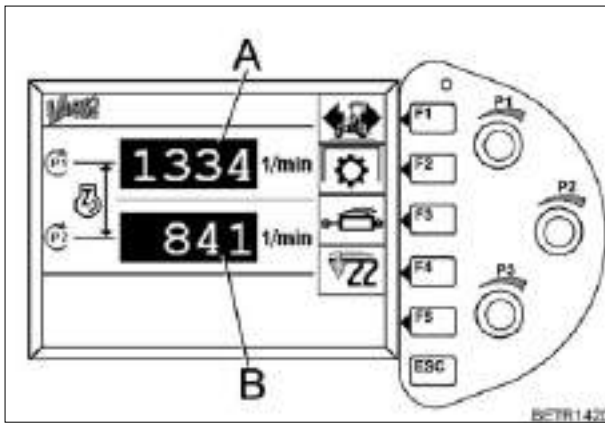

Fig.87

- Set maximum engine speed in Memory 1 (display A) with rotary control (P1).
- Set minimum engine speed in Memory 2 (display B) with rotary control (P2).

NOTE:

The maximum engine speed that can be set is the engine limit speed.
The minimum engine speed that can be set is the idle speed.

Activating engine control range

- F1 = Engine control range active while driving.
- F2 = Engine control range active when front/rear PTO is engaged.
- F3 = Engine control range active when hydraulic valve is actuated.
- F4 = Engine control range active when lowering a front/rear power lift.

Function display

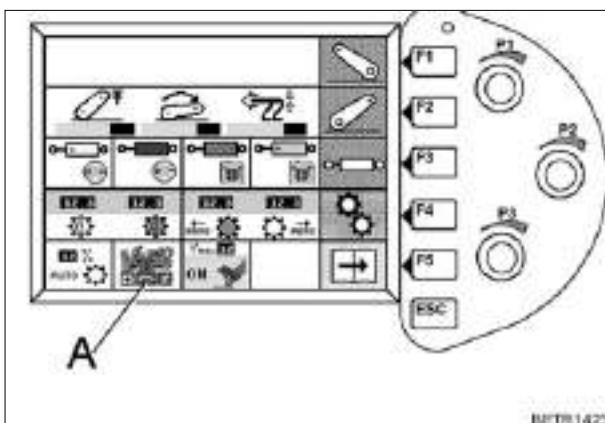

Fig.88

Different function displays appear on the main menu page.

Engine control range active while driving.



SCH180



SCH185



SCH181



SCH182



SCH183



SCH184



SCH185



SCH186



SCH187

NOTE:

Engine control is interrupted if the footbrake or exhaust brake is actuated. After releasing the footbrake, engine control is reactivated. If the tractor is at a standstill and the transmission is in neutral, the engine control for the front/rear PTO or hydraulic valves or front/rear power lift is active. Engine control switches off, if the driver leaves the driver seat for more than 3 seconds while the tractor is driving and/or the transmission is not in neutral.

10. PTO



DANGER:

Switch off the engine before attaching or removing drive shaft, and before cleaning, servicing or repairing PTO-driven implements. Always wait for the implement to come to a complete standstill!

Do not operate the PTO before all safety devices are in place.

Observe the specified pipe overlap requirements for the drive shaft. During PTO operation make sure no-one remains in the hazard zone!

When operating with overrunning implements, use a drive shaft with overrunning clutch.

10.1 Rear PTO



DANGER:

After operating the PTO, set rpm selector to 'O' and cover the PTO stub shaft with the protective sleeve.

IMPORTANT:

If the permissible torque is exceeded due to the nature of the operation, use drive shaft with overload coupling.

Drive shaft attachment

To prevent unsteady running, ensure that the drive shaft is linked correctly.

A = incorrect

B = correct

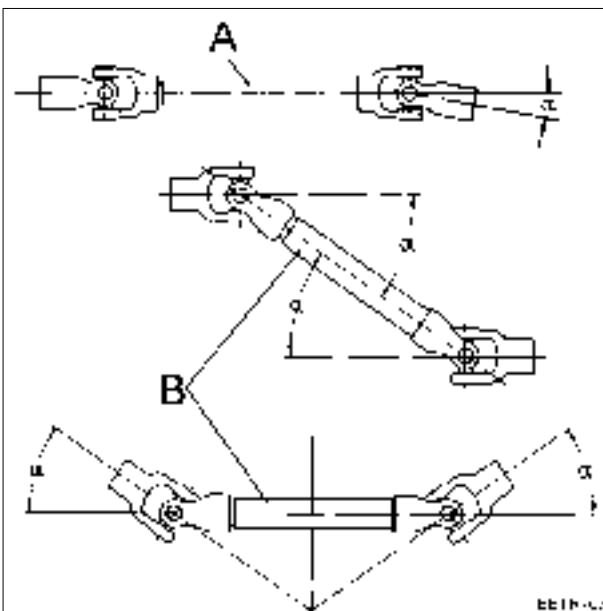

Fig.89

NOTE:

See also propeller shaft manufacturer's Technical Manual.

PTO shaft protection sleeve

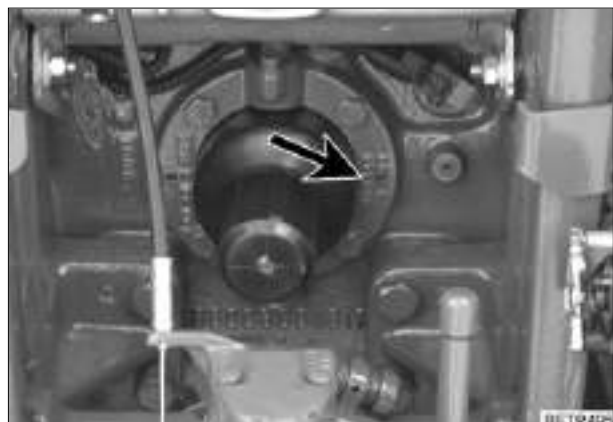

Fig.90

Direction of PTO rotation: see arrow.

PTO protection

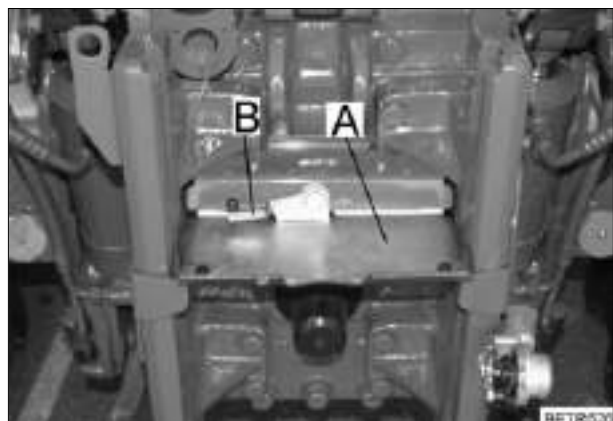

Fig.91

Before operating the rear PTO, attach the PTO protective plate (A) as shown and lock with lever (B).

NOTE:

If the trailer hitch is disconnected at the PTO protection plate point, the PTO protection is not required.

OPERATION

Selecting PTO speed

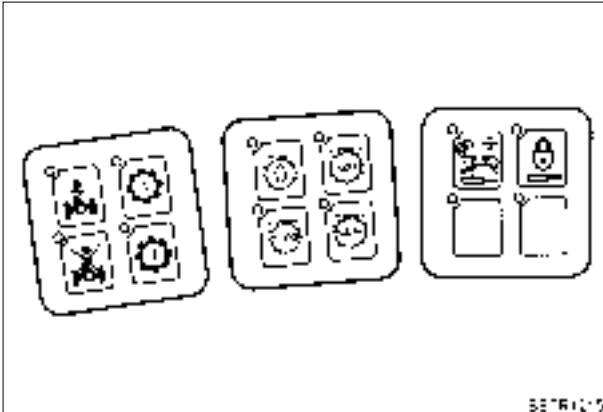

Fig.92

- Select the desired PTO speed with one of the following buttons.



PTO 540



Economy PTO (750)



PTO 1000



PTO neutral

NOTE:

As long as the LED next to the selected key is blinking, the changeover is still taking place or the PTO is still operating. PTO cannot be engaged.

If the LED next to the button pressed is lit, the PTO speed is switched on. The PTO can now be engaged.

NOTE:

At transmission temperatures below $-10\text{ }^{\circ}\text{C}$.
- first switch PTO speed to Neutral, wait for 5 seconds, then select a new PTO speed.
- after selecting PTO speed, wait for 5 seconds, then engage the PTO.

10.2 Engaging and disengaging rear PTO



DANGER:

Before engaging PTO, make sure no-one remains in the implement's hazard zone.

The selected PTO speed must be in accordance the permitted implement speed.

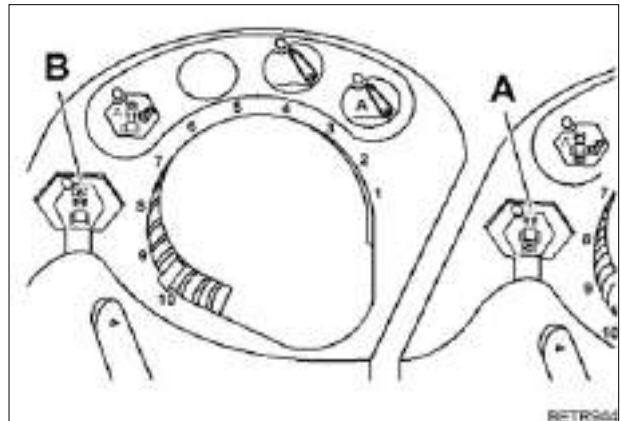

Fig.93



The rear PTO can be engaged/disengaged using the button (A).

When the PTO is engaged, the LED beside the button is lit.

The coupling process depends on the length of time the button is pressed:

Less than 5 sec.

Smooth start, PTO clutch adapts automatically to the requirements of the implement.

More than 5 sec.

Speed and electronic monitoring are bypassed.

NOTE:

If no PTO speed has been selected when engaging the PTO, the PTO disengages after a few seconds and a warning message is displayed on the multiple display (see FAULTS AND REMEDIAL ACTIONS Section 1.1).

When changing PTO speeds, always shift to neutral first, then select the desired PTO speed.

For implements that require high initial power, disengage the rear PTO with pushbutton (A) (see OPERATION Fig. 98).

External operation



Fig.94

- Press button (arrowed) on the right or left of the rear lamp.

Safety lock

The PTO rotates only as long as the button (arrowed) is pressed.

If the button is kept pressed until red light in the button comes on, the PTO shaft remains engaged.

Flange PTO shaft

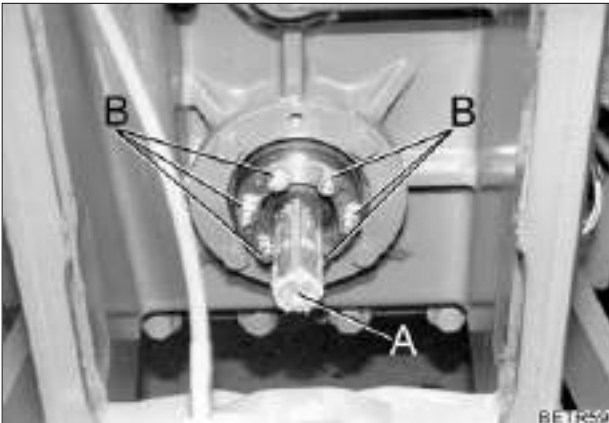

Fig.95

*Flanged shaft 1 3/8 21-part involute spline.

Flange PTO shaft 1 3/4 6-part splined profile.

Flange PTO shaft 1 3/4 20-part involute profile.

*Flange PTO shaft 1 3/8 6-part splined profile.

* Only for implements with a power requirement of 103 kW/140 HP max.

IMPORTANT:

When flanged shaft (A) is changed, tighten hexagon bolts (B) at a torque of 69 Nm.

10.3 Front PTO

(optional).



DANGER:

After operating the front PTO, switch off the season selection and put the protective sleeve back on the PTO stub shaft.

PTO shaft protection sleeve



Fig.96

Season selection

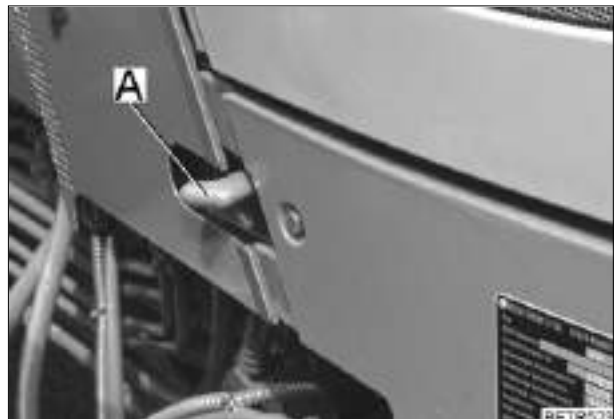

Fig.97

Turn off the engine.

Engage season selector with lever (A).

OPERATION

10.4 Engaging and disengaging front PTO

! DANGER:
Before engaging PTO, make sure no-one remains in the implement's hazard zone.

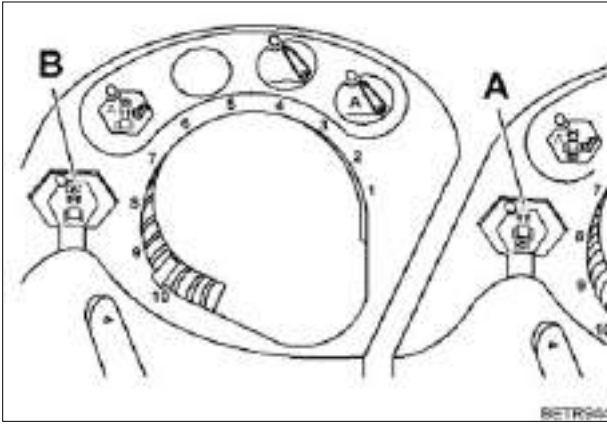

Fig.98

The front PTO shaft rotates clockwise in the direction of travel.



The front PTO can be engaged and disengaged using key (B).

When the PTO is engaged, the LED beside the button is lit.

The coupling process depends on the length of time the button is pressed:

Less than 5 sec.

Smooth start, PTO clutch adapts automatically to the requirements of the implement.

More than 5 sec.

Speed and electronic monitoring are bypassed.

10.5 Calibrating rear and front PTO coupling

! DANGER:
During calibration, PTO may rotate slightly.
Follow all safety procedures.

The PTO clutch is adjusted to adapt the engage process to the implement concerned, e.g. implements that require high initial power to start. The values determined during adjustment are used for the engaging process in the future. The adjustment is to be made only with the implement connected.

Calibrating rear PTO coupling mode

- Start engine.

Any fault messages must be cancelled individually.



Press key and hold.



Then press key. The fault message is now cancelled.

If no fault is indicated:



Press button - the following screen appears.



The wrench symbol flashes.



Press button **twice**, the following screen appears.



The wrench symbol flashes.



Press key. The next image appears.



Input code **6034** for rear PTO.



Press one of the keys until desired digit appears.

400401



Storing with the button. Once the last number has been saved, the following screen appears.

400402



400403

Select any PTO speed and engage rear PTO.

If the adjustment is completed successfully, an **OK** is displayed, and the new settings are stored.

If incorrect values are detected or the conditions are not met, an **ERROR** message is displayed.



Press button.

400407

- The new data are applied by turning the ignition OFF and ON.

Adjusting the front PTO clutch

- Start engine.

Any fault messages must be cancelled individually.



Press key and hold.

400402



Then press key. The fault message is now cancelled.

400406

If no fault is indicated:



Press button - the following screen appears.

400407



400408

The wrench symbol flashes.



Press button **three times**, the following screen appears.

400409



400410

The wrench symbol flashes.



Press key. The next image appears.

400402



400407

Input code **7034** for front PTO.



Press one of the keys until desired digit appears.



400401



Storing with the button. Once the last number has been saved, the following screen appears.

400402



400403

Engage front PTO.

If the adjustment is completed successfully, an **OK** is displayed, and the new settings are stored.

If incorrect values are detected or the conditions are not met, an **ERROR** message is displayed.



Press button.

400407

- The new data are applied by turning the ignition OFF and ON.

OPERATION

11. Four wheel drive (4-WD)

Front-wheel drive can be engaged or disengaged under load.

To avoid unnecessary noise level and excessive tyre wear, do not use front-wheel drive for ordinary road travel. It may however become useful to engage it on difficult road surfaces or in conditions of ice and snow.

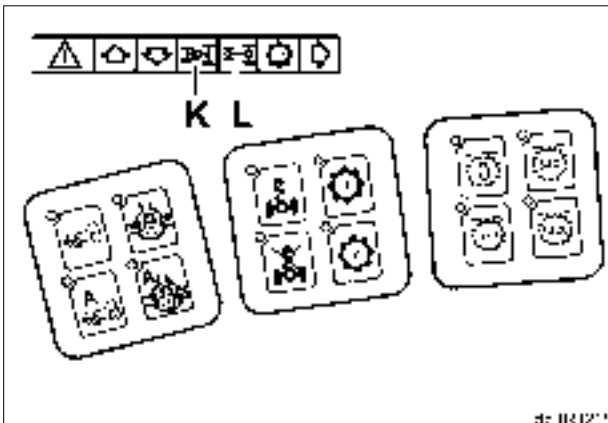

Fig.99

4-WD ON/OFF.

Press the button to engage / disengage the 4-WD.

When 4-WD is engaged, the lamp beside the button and indicator lamp (K) are lit.

4-WD automatic mode ON/OFF.

Press button to switch 4-WD automatic mode on or off.

At speeds greater than 20 km/h the 4WD is automatically disengaged, and reactivated at speeds below 20 km/h.

It is also automatically disengaged when the steering angle is greater than 25°, and reactivated below 25°.

When the automatic 4WD function is engaged, the corresponding LED is illuminated.

Indicator lamp (K) lights up when 4WD is engaged automatically.

12. Differential lock



DANGER:

Do not use on normal roads or when cornering.

Maximum speed 20 km/h.

Do not operate steering clutch brake.

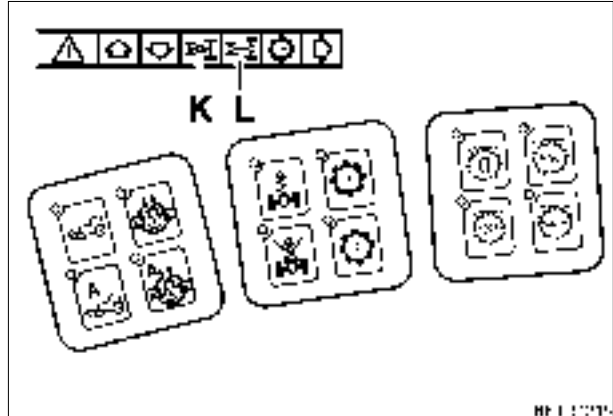

Fig.100

Differential lock ON/OFF.



Press this key to engage and disengage differential lock.

When differential lock is engaged, corresponding LED and indicator lamp (L) are illuminated.

Differential lock (automatic mode) ON/OFF.



Press key to switch the automatic differential lock function on or off.

At speeds greater than 20 km/h differential lock disengages automatically and must be re-selected below 20 km/h.

It is also automatically disengaged if the steering angle is greater than 15°, and engaged again below 15°.

It is also disengaged if the foot brake is operated, and engaged again when the foot brake is released.

When the automatic differential lock function is on, the corresponding LED is illuminated.

Indicator lamp (L) is lit, when differential lock engages automatically.

13. Front axle suspension



DANGER:
When the tractor is stationary, raising or lowering the tractor body is dangerous for people in the vicinity of the front axle.

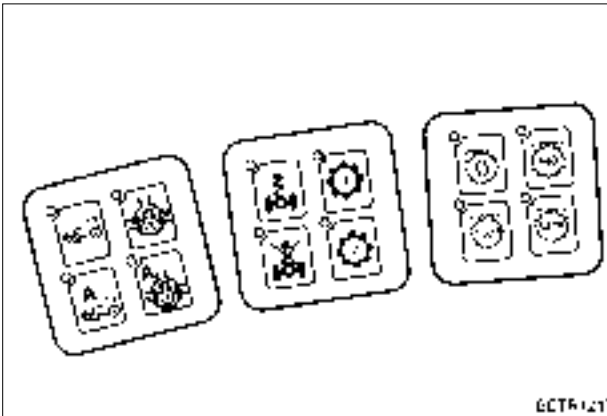

Fig.101

Function can only be selected while the engine is running.

Suspension OFF (locked).



Tractor body is lowered to the stop at the front axle.

Suspension ON (level control).



With the tractor stopped:
If the button is pressed for more than 3 seconds, the body continues to rise through the total suspension range, as long as the button remains pressed. Only when speed exceeds 2 km/h. will the frame adjust automatically to the intermediate position of the suspension range.

At speeds above 2 km/h:

By pressing key, tractor frame is raised and its height maintained in the intermediate position of suspension range.

Levelling control may be temporarily deactivated for one of the following factors:

1. brakes are applied.
2. ground speed is below 2 km/h.
3. front axle load too high.

NOTE:

When the tractor is started, the function selected last is activated.

OPERATION

14. Power lift and PTO automatic mode

14.1 Power lift automatic mode

Automatic mode allows the control of the rear and front power lift to be transferred to the buttons on the joystick.

If the basic settings are not suitable, any setting can be selected with the **Variotronic TI**.

Activating the automatic function

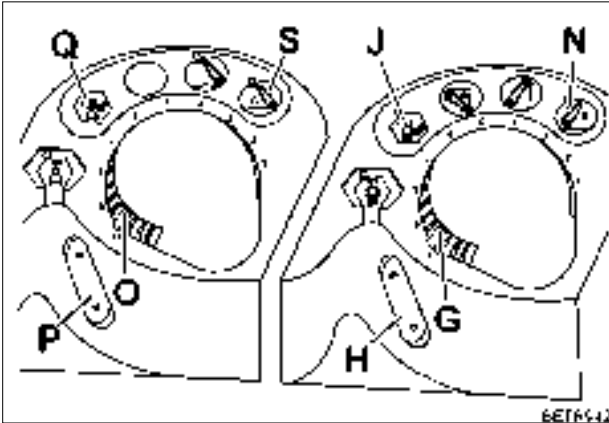

Fig.102

- Unlock power lift (see also OPERATION Section 18.2).
- Depth control (O) front, and (G) rear.



Button (N), automatic rear power lift function ON/OFF.



Button (S), front power lift automatic mode ON/OFF.

The automatic function can be deselected at any time.

NOTE:

The automatic function can be by-passed with the fast lift switches (H) or (P).

Example:

Lifting gear set to automatic function, fast lift switch to Lift, lifting gear raised. The lamps next to automatic mode buttons (N) and (S) remain lit.

Automatic mode only becomes active again when Quick Lift switches (H) or (P) are at centre position.

Using automatic mode

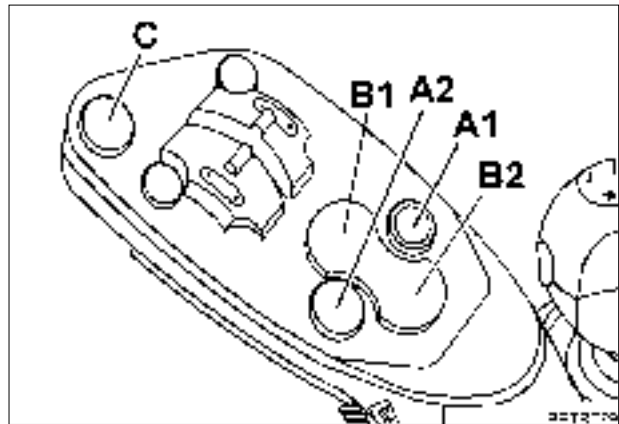

Fig.103

- Button (A1), the front power lift goes into 'Control' mode.
- Toggle switch in direction (B1), the rear power lift goes into 'Control' mode.

Power lift is lowered to the value set using depth control (G or O, see OPERATION Fig. 104).

- Button (A2), front power lift goes into 'Raise' mode.
- Press rocker switch in direction (B2), rear power lift goes into lift mode.

Power lift rises to the set upper limit.

- Stop button (C), power lift (front/rear) remains at the current position.

The power lift can now be moved using the buttons.

NOTE:

The external Raise/Lower buttons on the front and rear of the tractor remain active, and have priority even with the automatic mode active.

If the lifting gear is moved with the external control buttons, the EPC is locked and automatic mode must be switched on again.

14.2 PTO automatic mode

Allows the control of rear and front PTOs to be transferred to the buttons on the joystick.

Activating the automatic function

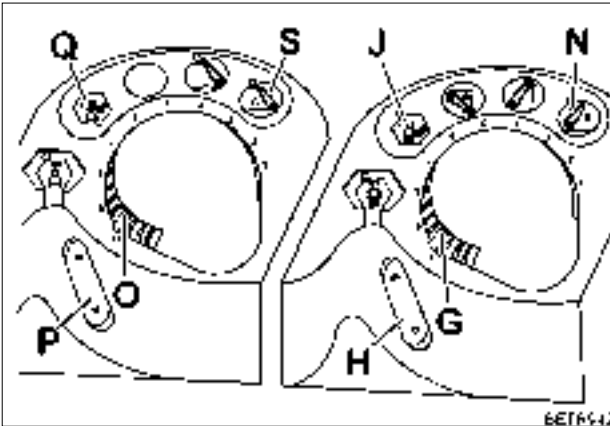

Fig.104

- Selecting PTO speed for rear PTO, (see OPERATION Section 10.1).
- Button (J), rear PTO automatic mode ON/OFF.
- Button (Q), front PTO automatic mode ON/OFF.

NOTE:

The automatic function can be deselected at any time.

Using automatic mode

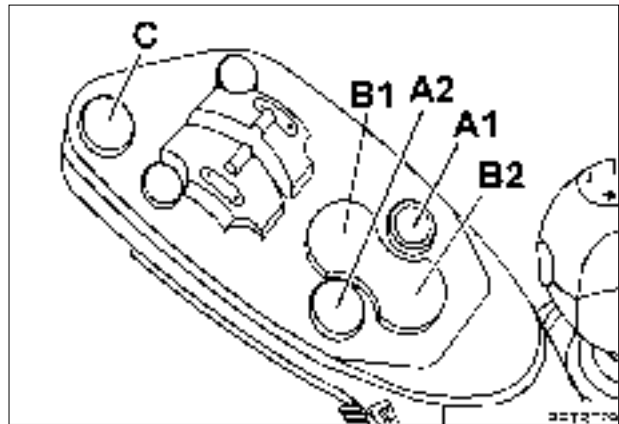

Fig.105

- Button (A1), front PTO ON.
- Button (A2), front PTO OFF.
- Toggle switch to (B1), rear PTO ON.
- Toggle switch to (B2), rear PTO OFF.
- Stop button (C), PTOs (front and rear) are both disengaged.

NOTE:

The PTO automatic mode can be activated with PTOs engaged or disengaged.

OPERATION

14.3 PTO automatic mode with power lift

Allows the control of front and rear PTOs, and the front and rear lifting gear to be transferred to the buttons on the joystick.

The PTOs are engaged and disengaged at the preset position of the power lift.

Activating the automatic function

- Activating power lift automatic mode (see also OPERATION Section 14.1).
- Activate PTO control transfer (see also OPERATION Section 14.2).

Using automatic mode

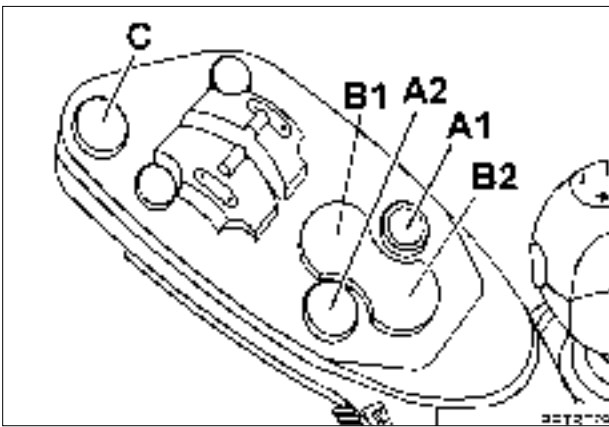

Fig.106

- Button (A1), the front power lift goes into 'Control' mode. The rear PTO engages when the front power lift overruns a preset position.
- Button (A2), front power lift goes into 'Raise' mode. The front PTO disengages when the front power lift overruns a preset position.
- Button (B1), the rear power lift goes into control mode. The rear PTO engages when the rear power lift overruns a preset position.
- Button (B2), rear power lift goes into Raise mode. The rear PTO disengages when the rear power lift overruns a preset position.
- Stop button (C), power lift (front/rear) remains at the current position. If the PTO's were engaged, they will now be disengaged.

NOTE:

In automatic mode, the buttons on the joystick have equal priority with the buttons for normal mode. After operating with the normal mode buttons, the PTOs can be re-engaged with the joystick buttons.

NOTE:

When the travel speed is greater than 25 km/h, the automatic function is switched off.

If the driver seat is unoccupied for more than 3 seconds, automatic mode is stopped.

15. Brakes

! DANGER:
Before each trip, always check the brakes.

15.1 Foot brake

! DANGER:
On normal roads, and when pulling trailers equipped with air brakes, lock the brake pedals together (independent wheel braking is not permitted).



Fig.107



Fig.108

- For independent wheel braking (steering clutch brake), unlock the brake pedals.
- Press the pedal for the inner wheel.

NOTE:

Use the steering clutch brake only at low speeds, and never jerk it; do not use with the differential lock engaged.

15.2 Hand brake

! DANGER:
When parking the tractor, always immobilise with the hand brake; on slopes, also place chocks at the wheels.

Hand brake

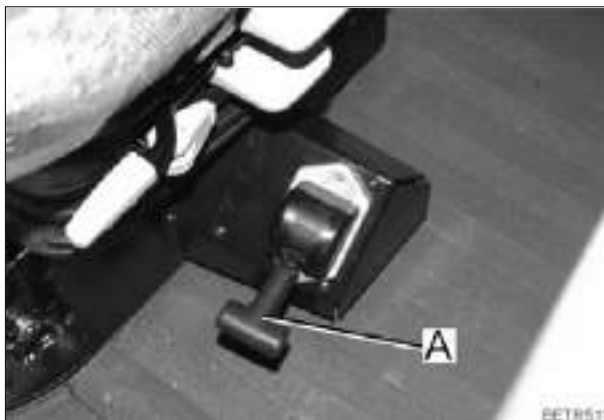

Fig.109

When the hand brake (A) is applied, the transmission is automatically shifted to neutral position, if speed goes under 2 km/h within 2 secs..

Displays when in neutral position

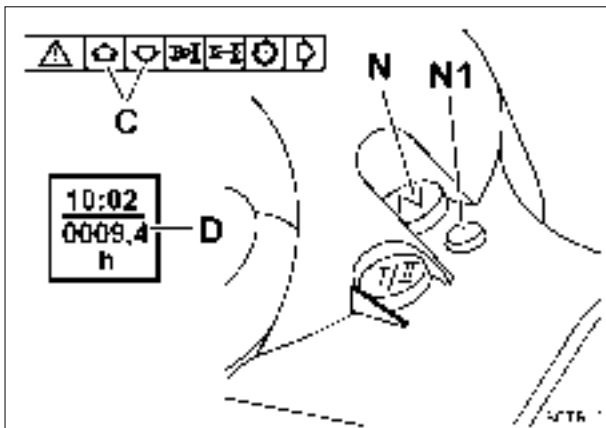

Fig.110

1. LED (N1) lights up.
2. Direction of travel indicator lamps (C) are flashing.
3. Clock and operating hours (D) are shown on the multiple display.

- When the parking brake is activated, the neutral position can be cancelled with the neutral button (N) (Starting assistance).
If the hand brake is not released within 30 seconds, or the speed is not above 2 km/h, the transmission returns to neutral.

OPERATION

Brake release screw



Fig.111

If there is no pressure in the compressed air system, the hand brake can be released with the brake release screw (A).

- Screw in the brake release screw (A) up to the stop; the hand brake after about another 5 turns.

15.3 Trailer brake

For transport operations, please refer to the country-specific regulations for trailer brake systems.

Trailers with hydraulic brakes should not be towed at over 25 km/h. Above 40 km/h, trailers must be retarded by air brakes.

Hydraulic trailer brake

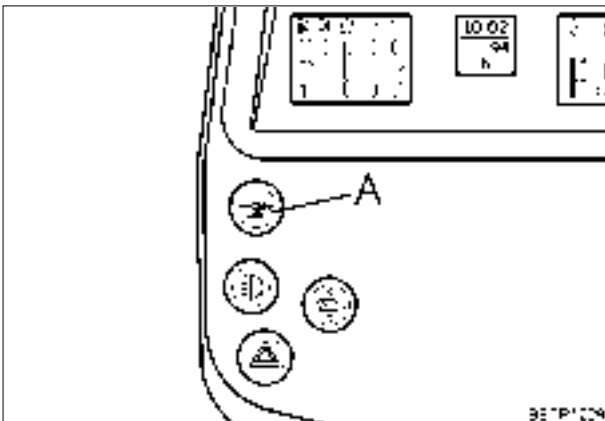

Fig.112

The hydraulic trailer braking systems is active as soon as the foot brake or parking brake is activated with the engine running.

To release pressure in the hydraulic trailer brake while the engine is running and the hand brake is applied:

- Press pushbutton (A).

15.4 Engine brake

(optional).

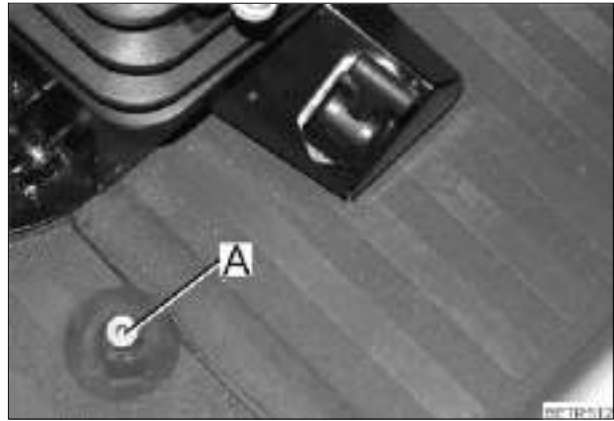

Fig.113

- Press pushbutton (A).

Engine brake only becomes effective at an engine speed above 900 rpm.

Full braking effect at high engine speeds only.

NOTE:

**Maximum permissible engine speed
2,600 rpm.**

16. Steering



DANGER:

In case of complete failure of the hydraulic power for the assisted steering, the tractor remains controllable. However, greater force is required to steer.

Do not exceed 10 km/h!

Stop the tractor immediately if there is a fault with the hydrostatic steering. Have the fault repaired as soon as you can at a FENDT service workshop.

Never adjust the steering wheel while the tractor is moving!

16.1 Steering wheel adjustment

The steering wheel can be height-adjusted by 75 mm and inclined at any angle within 30°.

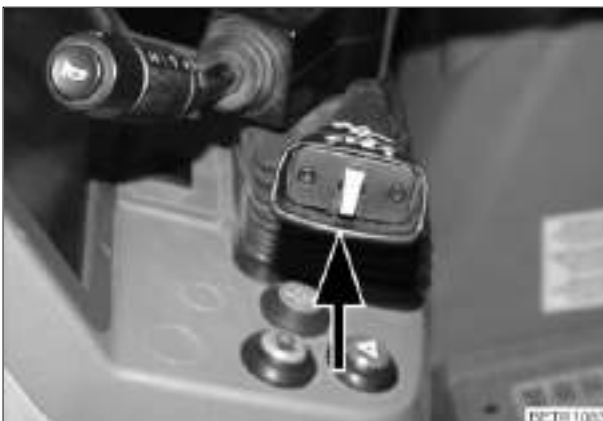

Fig.114

Height adjustment:

- Lift lever half way.

Height and angle adjustment:

- Pull up lever all the way.

17. Hydraulics



DANGER:

When working with hydraulic equipment, make sure no one is standing within the working area. Do not stand beneath a raised load. Always follow the accident prevention regulations! When hydraulic operation is complete, lock all hydraulic valves.

17.1 General notes on hydraulic operations



DANGER:

When hitching implements to the tractor, there is a risk of injury. Never stand between tractor and attachment without having first secured the vehicle to prevent it from rolling away. (Apply parking brake, chock the wheels.)

Only operate three-point linkage externally from a safe position.

For road transport, raise the implement to the necessary height and lock the operating levers. Make sure the EPC is positioned in transport position. When transporting a plough with castor support wheel, lock lateral stabilisers and unhook top link. When cornering, allow for overhang and the oscillating weight of the implement. Before leaving the tractor, fully lower mounted implements. Switch off the engine and remove the ignition key. Make sure detached implements are securely parked.

Three-point implement must have standardised connection dimensions; if necessary, fit suitable ball profile for quick-release coupling to towbar mounting.

Do not operate the hydraulics with cold oil. If necessary, allow the engine to run at medium speed for a few minutes.

Stop tractor immediately in case of overheating of hydraulics.

OPERATION

17.2 Valve locking

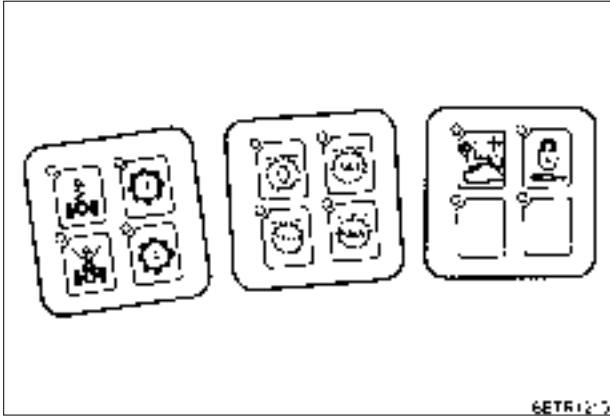

Fig.115

NOTE:

When the engine is started, all the valves are locked (for safety reasons).



The valves can be locked/unlocked with the button.

Unlock only the valves shown on the valves submenu as unlocked.

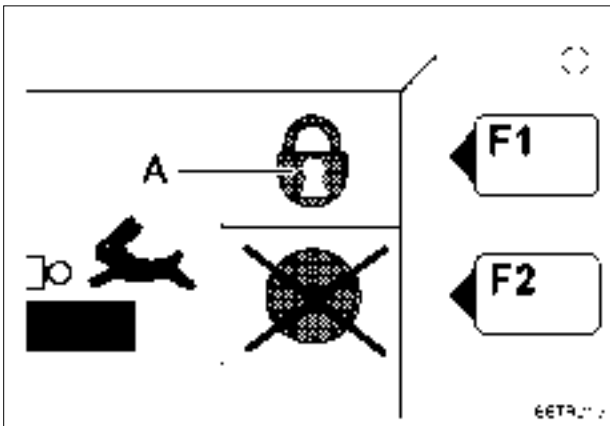

Fig.116

Locking individual valves.

- The key (F1) can be used to activate and deactivate valve locking.

When the valve is locked, symbol (A) is displayed as shown.

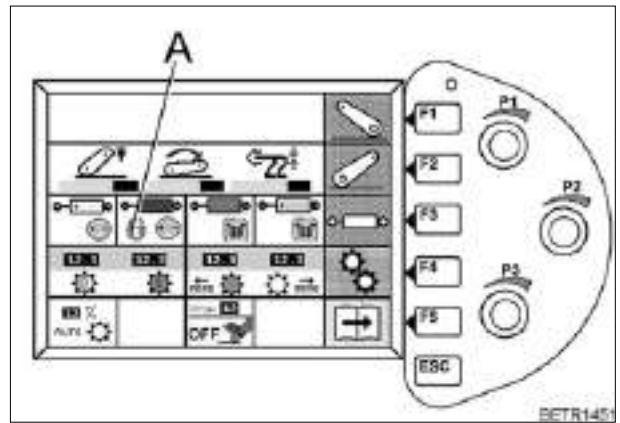

Fig.117

When the valve lock is activated, symbol (A) appears in the main menu.

17.3 Valve equipment

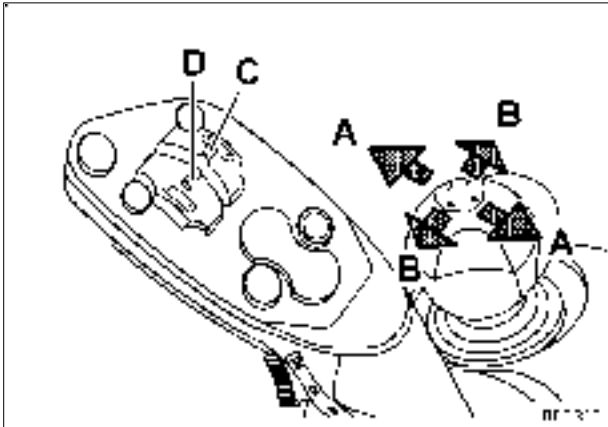

Fig.118

The four available hydraulic valves are identified by the colours yellow, blue, red and green in all the valve sub-menus, on the operating controls and on the caps for front and rear connections.

- Yellow valve (standard) direction of actuation (A).
- Blue valve (standard) direction of actuation (B).
- Red valve (standard) toggle switch (C).
- Green valve (optional) toggle switch (D).

17.4 Operating the valves

NOTE:

After starting the tractor, the spool valves must be unlocked (see OPERATION Section 17.2).

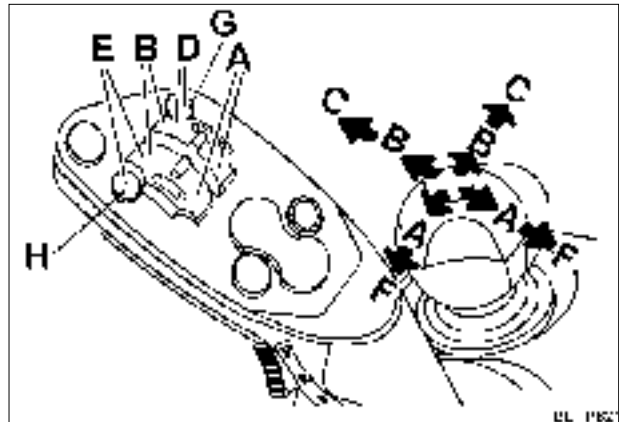

Fig.119

- A = Raise
- B = Lowering/pressure
- C = Floating position yellow and blue valves (red, green).
- D or G = Floating position red valve (yellow).
- E or H = Floating position green valve (blue).
- F = No function.

IMPORTANT:

If the timer function is active, after the valve is operated, it shuts off only after the preset time has expired.

Valve actuation indicator

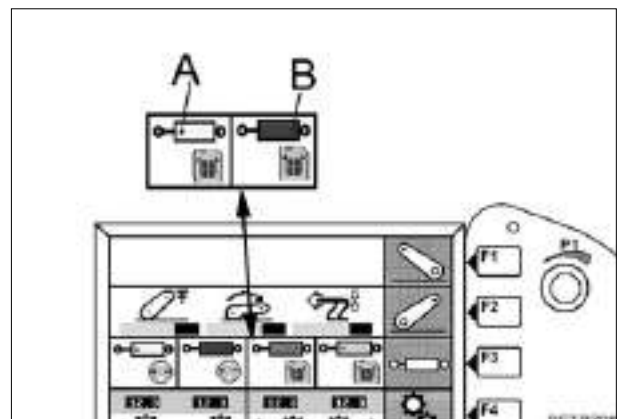

Fig.120

Symbols (A, B) appear whenever a valve is actuated.

OPERATION

Switching the valve controls

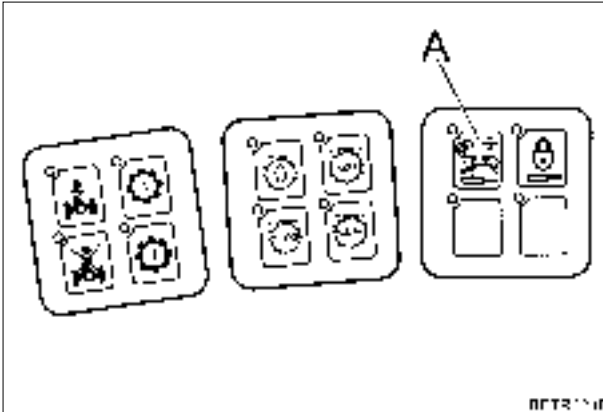

Fig.121

The valves controls can be switched over using button (A).

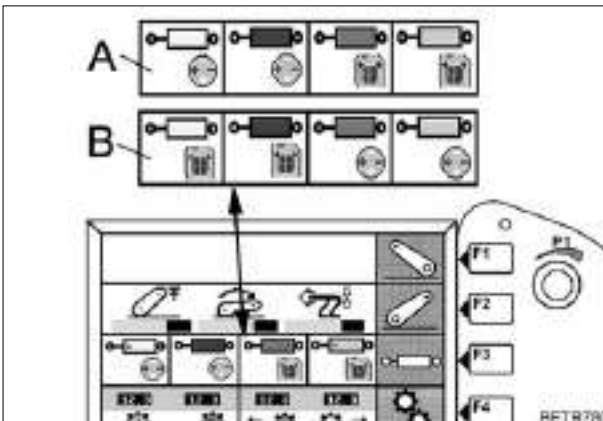

Fig.122

- A = The yellow and blue valves are operated with the crossgate lever, and the red and green valves are operated using the toggle switches on the joystick.
- B = Valves (red, green) are operated from the crossgate lever, valves (yellow, blue) are operated from the toggle switches on the joystick.

NOTE:

The new setting remains effective even when the tractor is restarted.

Do not keep the control valves at the end of travel for long periods (the hydraulic pump delivers against pressure, causing the oil to heat up).

Manual operation

In the event of electronic failure, the individual valves can also be operated manually.

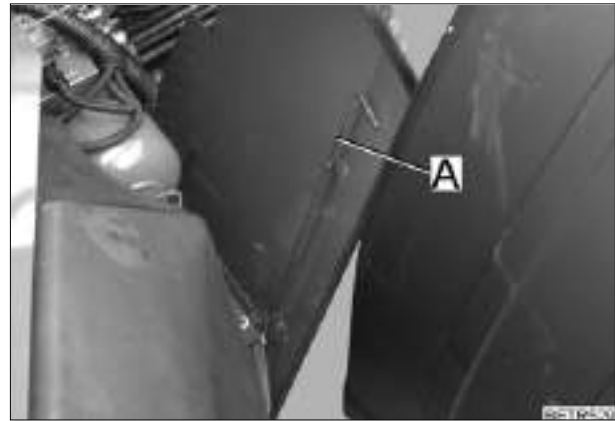

Fig.123

- Levers (A) under cover on right of doorway. Actuate the valves using lever.

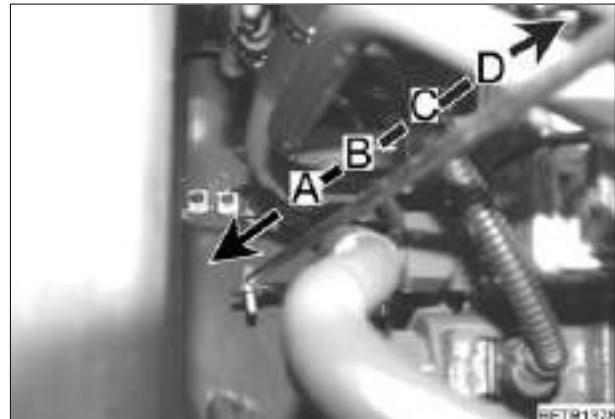

Fig.124

Directions of actuation:

- A = Raise
- B = Neutral
- C = Lowering
- D = Floating position



This screen is displayed as soon as a valve is operated manually, when the engine running.

NOTE:

After manual operation, the valves cannot only be operated again with the crossgate lever or toggle switches after a Reset (engine OFF then ON).

Valve heating

To ensure safe operation of the valves irrespective of ambient temperature, the valves are preheated when the engine is started.

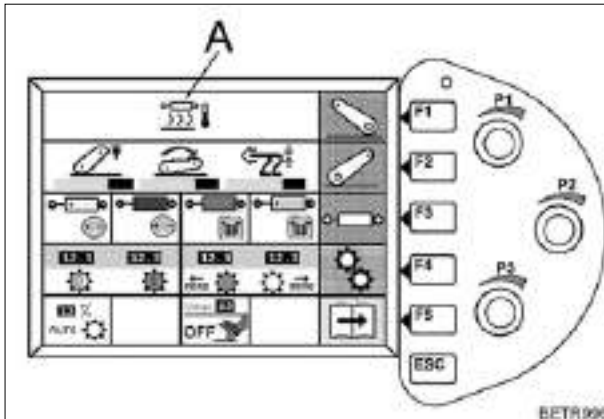

Fig.125

When the heating function is active, the symbol (A) appears.

17.5 Priority function

The priority function divides the available hydraulic oil to the four valves.

If more than one control unit is operated simultaneously and the oil quantity requirement exceeds the maximum oil quantity, the oil quantity of all participating control units is reduced per centually.

Priority valve function.

The proportional distribution can be deactivated for one control unit. The valve always receives oil quantity first displaced. If more oil is available, it is distributed proportionally to all other consumers.

Activating the priority function for one valve

Calling up the sub-menu for setting valves.

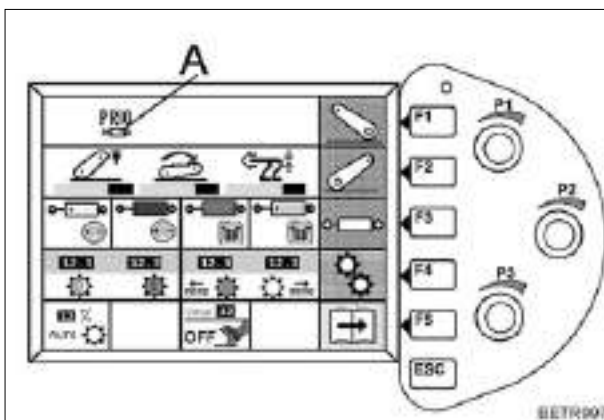

Fig.126

- Press key (F3). The following valve setting sub menu appears.

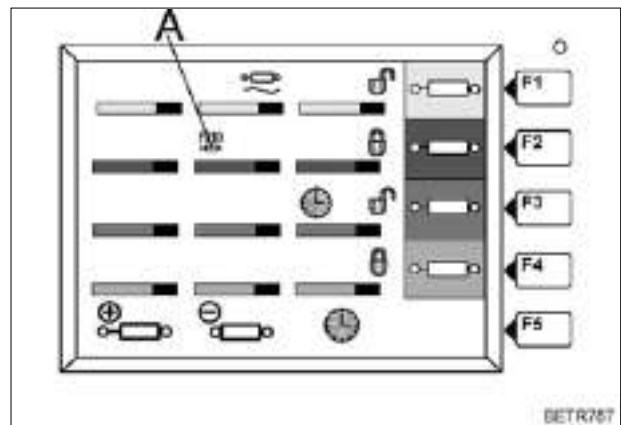

Fig.127

This window gives an overview of the individual valve settings.

Coloured display (A) of prioritised valve (appears if one valve is prioritised).

- Press key (F1 - F4) for the valve that is to be set. The following valve setting sub-menu appears.

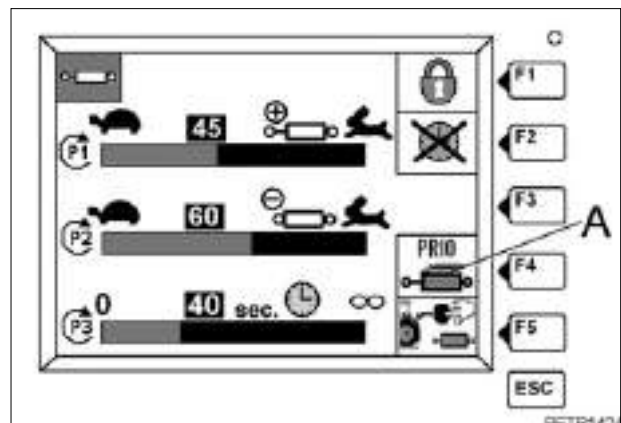

Fig.128

- The valve priority function is activated / deactivated with key F4.

Symbol (A) is displayed as shown if valve priority is active.

Symbol (A) is displayed **CROSSED OUT** if valve priority is not active.

Example application:

When operating a hydraulically driven sowing machine, the engine should be operated at a constant speed.

OPERATION

17.6 Setting the valves

The following settings can be made:

1. Flow rate
2. Timer
3. Floating position
4. Valve locking

Opening the valve setting submenu

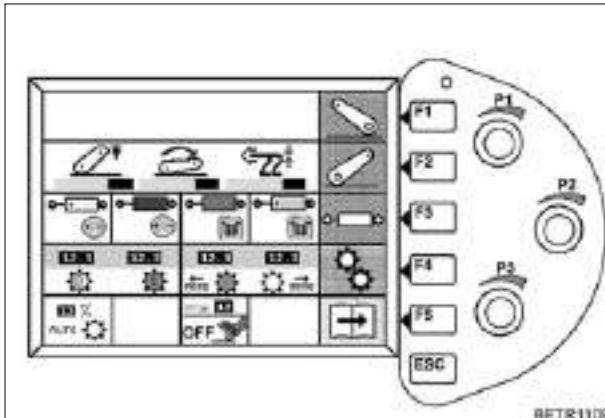

Fig.129

- Press key (F3). The following valve setting submenu appears.

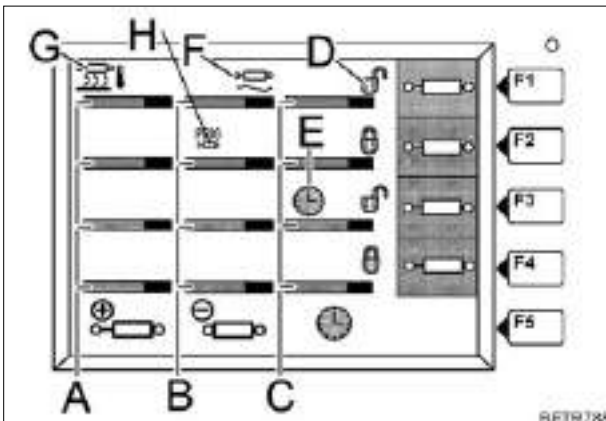

Fig.130

This window gives an overview of the individual valve settings.

- Indicator bars (A), lifting flow rate.
- Indicator bars (B), lowering flow rate.
- Indicator bars (C), activation period.
- Lock symbol (D), valve locking ON/OFF.
- Clock symbol (E), is displayed while the relevant valve is activated by the time function.
- Cylinder symbol (F), is displayed while the relevant valve is activated in the floating position.
- Valve prioritisation (H) appears if a valve is prioritised.
- Keys (F1 - F4), for changing to the sub-menu of individual valves.

Example:

- Press key (F1). The following submenu appears.

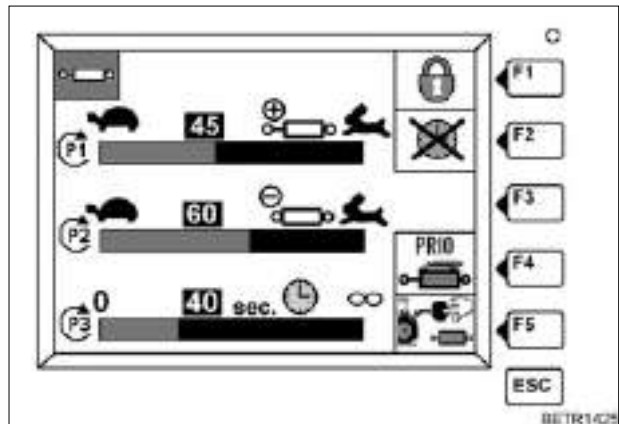

Fig.131

- Use the ESC key to exit this submenu and select a different valve.

Setting the flow rate for lifting/lowering

(Setting range between 1-80 l/min).

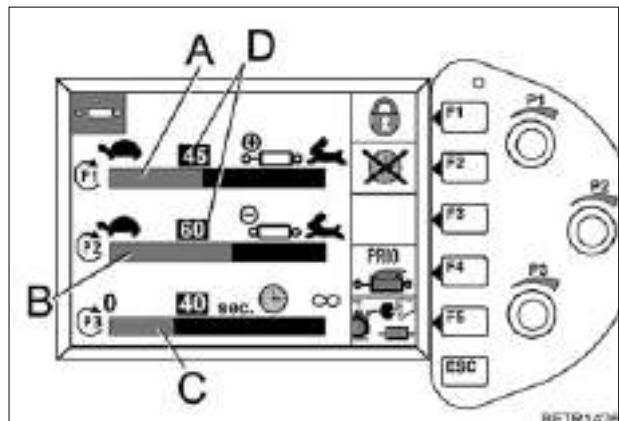

Fig.132

Bar indicator (A), lifting.

Bar indicator (B), lowering.

- Set the flow rate for lifting with rotary switch (P1), and for lowering with rotary switch (P2).

NOTE:

If only the bar indicator (A, B) changes and the indicator (D) remains unchanged, the hydraulics are undersupplied. Increase engine speed.

Timer function

Used to set the operating time for individual valves.

With a setting from 0 to 60 secs, once the valve is actuated, it switches off automatically after the set time.

If set to over 60 secs, the valve remains on continuously once actuated (on continuously for constant consumers).

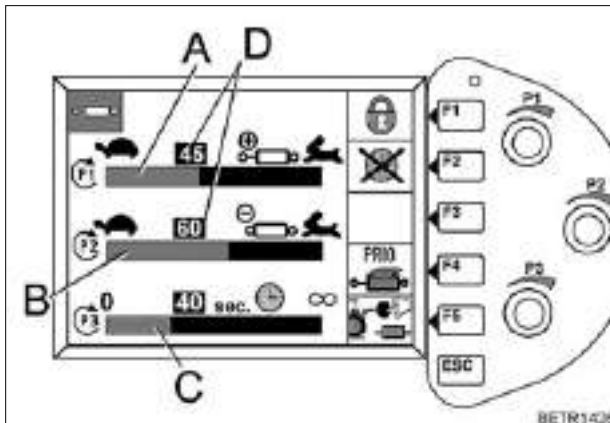

Fig.133

Bar indicator (C), operating time.

The number displayed above the bar shows the selected time in seconds.

- Rotary switch (P3), for setting the operating time.

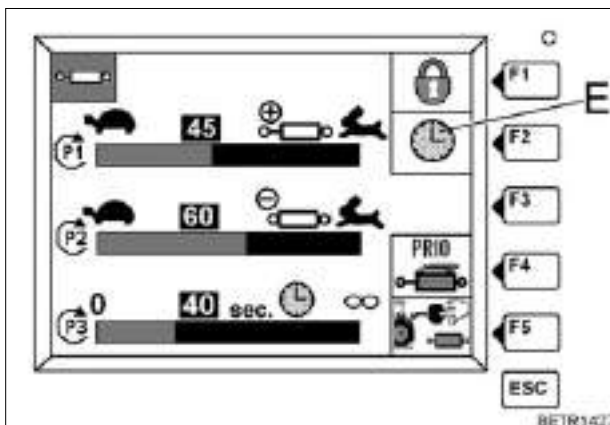

Fig.134

Selecting the timer function:

- Key (F2), timer function ON/OFF.

If time function has been pre-selected, symbol (E) is displayed as shown.

If the time function has not been pre-selected; the (E) symbol is displayed **CROSSED OUT**.

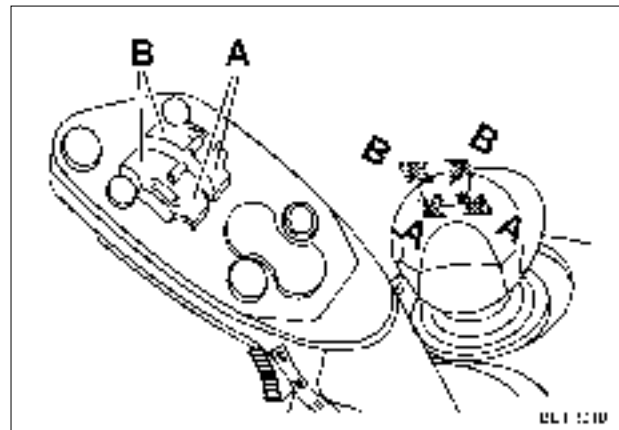

Fig.135

Switching the timer function on/off:

- If the crossgate lever is moved to RAISE (A) or LOWER (B) by more than 80 %, the corresponding valve switches on.
- If the crossgate lever is moved again, the valve cuts out immediately.
- If one of the toggle switches is moved to RAISE (A) or LOWER (B), the corresponding valve cuts in.
- If the toggle switch is moved again, the valve cuts out immediately.

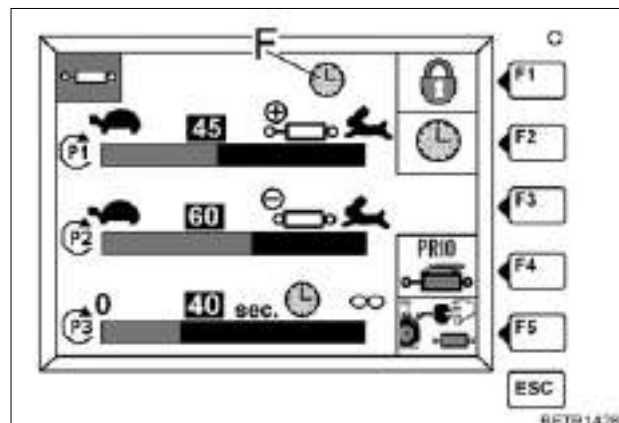

Fig.136

Clock symbol (F) is displayed as long as the corresponding valve is controlled with the timer function.

OPERATION

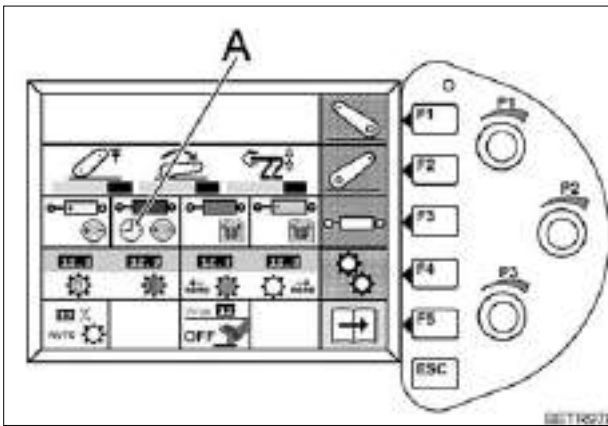

Fig.137

Clock symbol (A), also appears in the first main menu for as long as the appropriate valve is activated via the time function.

Floating position

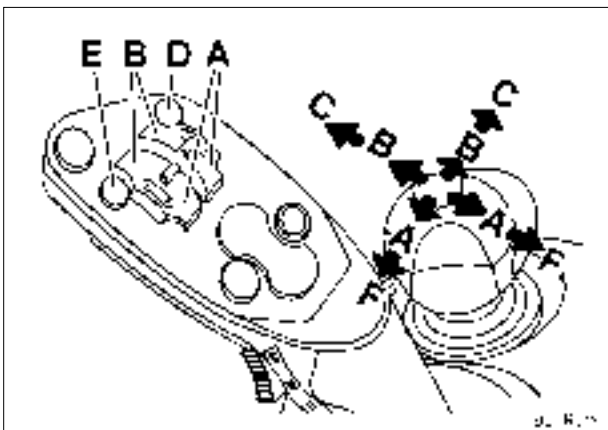

Fig.138

Activating and deactivating the floating position

- If the crossgate lever is briefly pushed briefly past LOWER (B) (position C), the corresponding valve moves to floating position.
- If the crossgate lever is moved in the same direction again, the floating position is immediately deselected.
- If the crossgate lever is moved towards RAISE (A) by more than 80% when the **preselected timer function** is on, floating position is deselected and the valve cuts in (see also timer function).
- If button (D or E) is pressed, the corresponding valve goes into floating position, **or** if one of the toggle is moved to LOWER (B) and the corresponding button (D or E) is pressed at the same time, the appropriate valve goes into floating position.
- If it is pressed again, the floating position is immediately deselected.

- With the **preselected timer function** active, if the toggle switch for the valve in floating position is pushed towards RAISE (A), floating position is deselected and the valve cuts in (see also timer function).

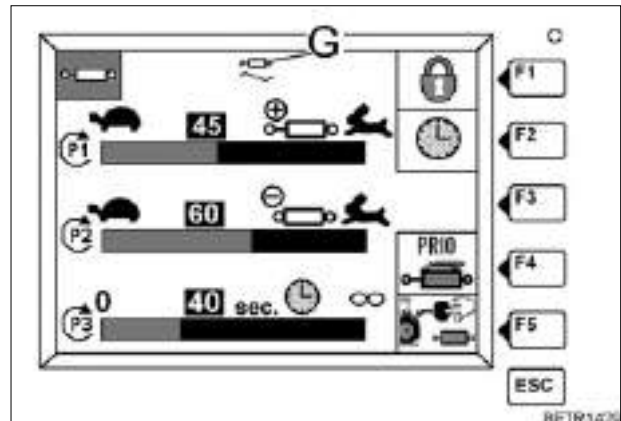

Fig.139

Cylinder symbol (G) is displayed as long as the corresponding valve is in the floating position.

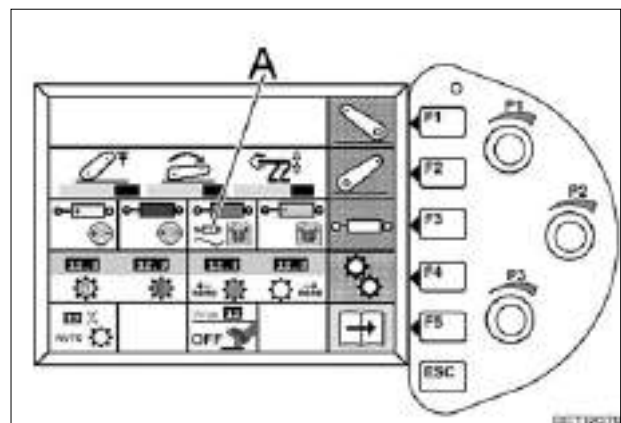

Fig.140

Cylinder symbol (A) also appears on the first main menu for as long as the corresponding valve is in floating position.

17.7 External valve actuation

! DANGER:
No consumers may be coupled at the front hydraulic connection when activating and using external valve actuation.

NOTE:
External actuation can only be activated for the 3rd and 4th valve.

Activating external valve actuation

Calling up the sub-menu for setting valves.

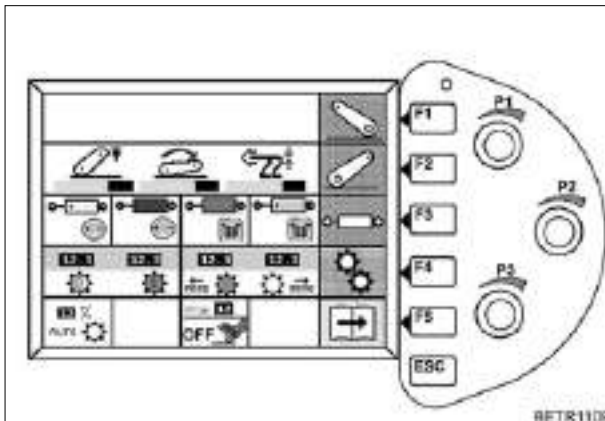

Fig.141

- Press key (F3). The following valve setting sub-menu appears.

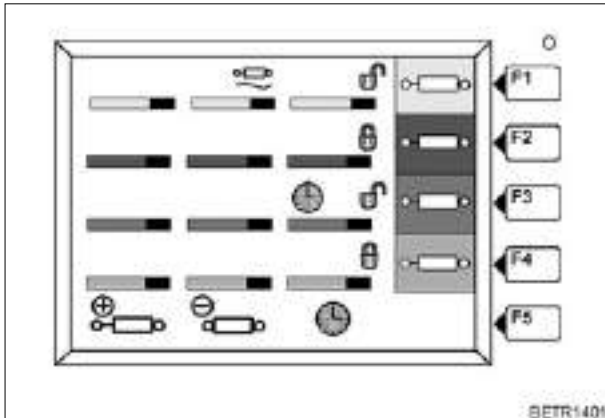

Fig.142

- Press key (F3 - F4) for the valve that is to be set. The following valve setting sub-menu appears.

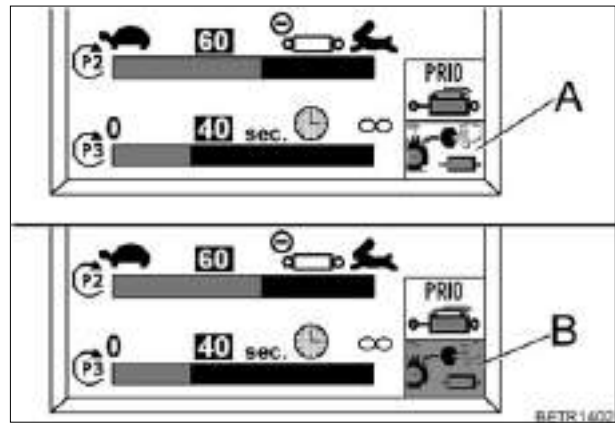

Fig.143

- External valve actuation is activated and deactivated with key (F5).

A = OFF
B = ON

Function display

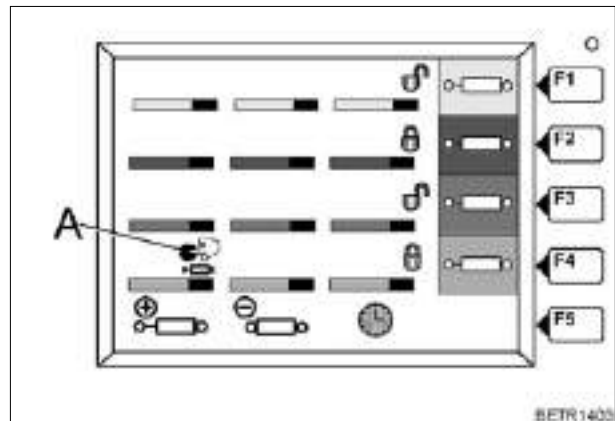

Fig.144

If external valve actuation is activated, symbol (A) appears in the valve setting sub-menu.

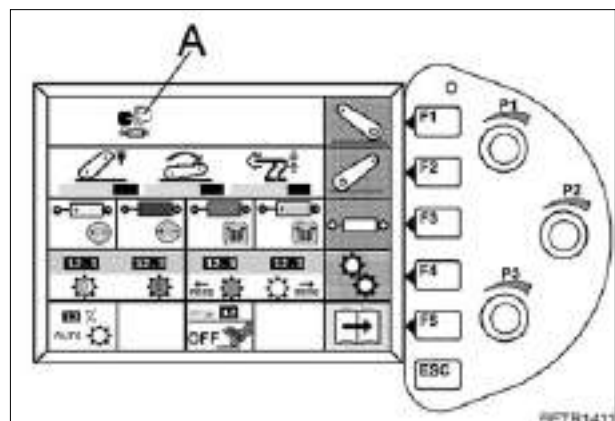

Fig.145

If external valve actuation is activated, symbol (A) appears in the main menu.

OPERATION

Rear external valve actuation

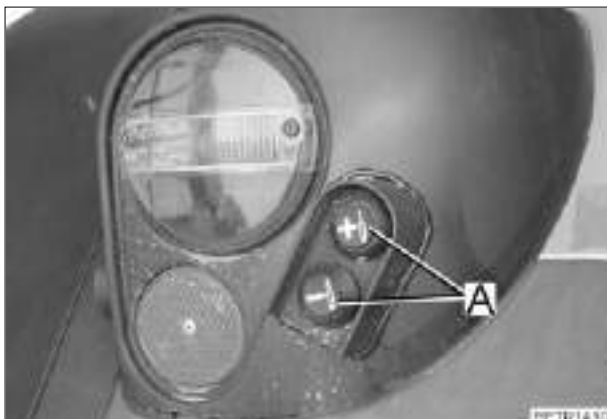

Fig.146

External control (lift/lower) of the selected valve with pushbutton (A).

NOTE:

The valve is operated as long as the pushbutton is pressed.

The rear controls have priority over the selected settings on the control panel/multi-function armrest.

The maximum hydraulic oil flow rate is approx. 30 l/min.

If the stopcock on the standard front power lift is open (see OPERATION Section 20.2), external actuation cannot be selected for that valve.

17.8 Hydraulic connectors



DANGER:

When connecting hydraulic cylinders and motors, make sure that all hydraulic hoses are correctly connected (load pressure side of cylinder to '+')!

Switching connections causes functions to be reversed (e.g. lifting instead of lowering), and may lead to accidents. After working with the hydraulic system, lock all the hydraulic valves!

When connecting external hydraulic consumers (e.g. hay loader), the best results are obtained by controlling them directly from the tractor, rather than through an additional control unit on the implement. The working speed of each consumer can be set individually.

NOTE:

It is easier to disconnect a pressurised connector from the implement by switching the corresponding control unit to floating position.

Hydraulic connections, rear

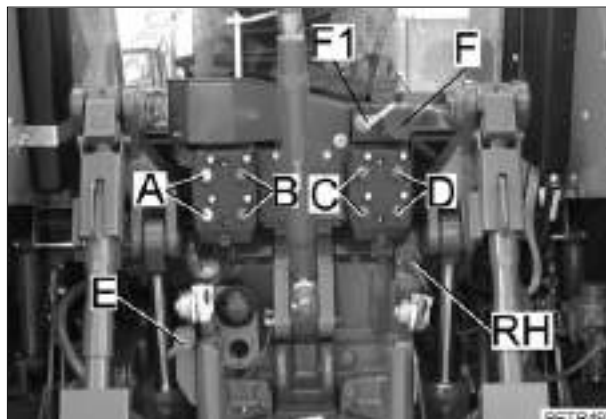

Fig.147

- A = Yellow valve.
- B = Blue valve.
- C = Red valve.
- D = Green valve.
- E = Hydraulic trailer brake (optional).
- RH = Return line at rear, black colour markings.

External hydraulic connection

(optional).

With this connection, an implement such as a harvester can be supplied directly from the hydraulic pump.

F = Pump pressure line.

F1 = LS control line (Load Sensing).

NOTE:

Implement must be equipped with Load Sensing control.

Turn tractor off when coupling and uncoupling.

Increasing external control pressure

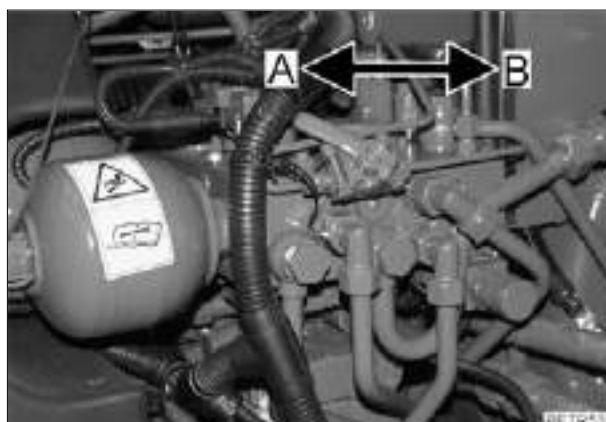

Fig.148

The adjustment lever can be used to select between 28 bar (A) and 20 bar (B).

Basic setting is 20 bar.

Use the 28 bar position for implements with long hoses, for load sensing signal / or external pressure supply (for example with manure vat).

NOTE:

In the 28 bar position, there are higher hydraulic losses, which cause the oil to heat up.

Front hydraulic connections

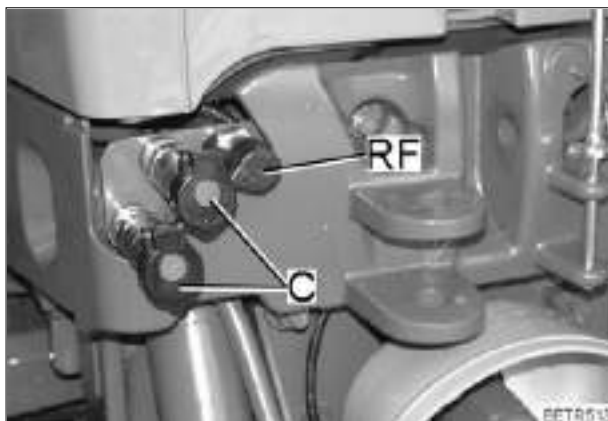

Fig.149

- C = Red valve.
- RF = Front return flow.
(black coding).

18. Electronic lifting gear control, rear

18.1 Controls

Operating console, right side

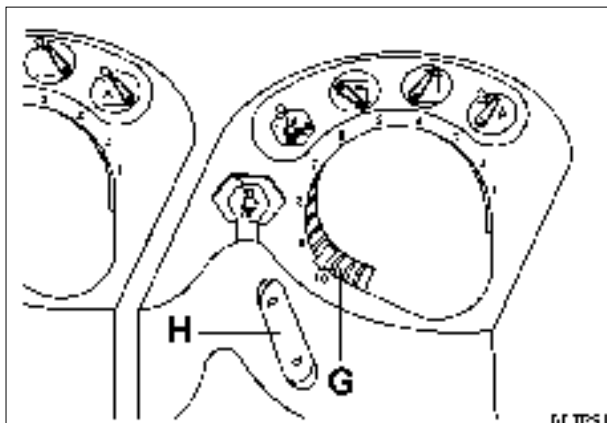





Fig.150

- G = Depth control
- H = Quick Lift key
-  Fast feed-in
-  Hitch-lift
-  EPC automatic mode
(also refer to OPERATION Section 14.1).

Vario terminal

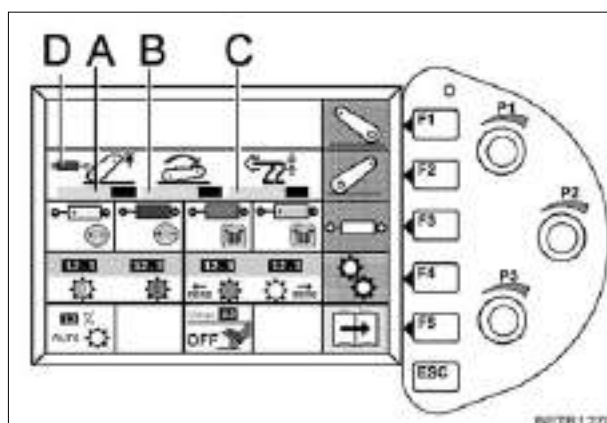

Fig.151

- A = Lift height
- B = Lowering speed
- C = Position/traction mix control
- D = DA function active indicator

OPERATION

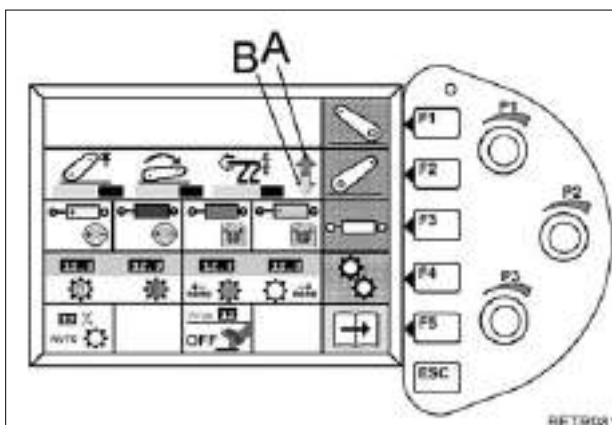

Fig.152

Symbols (A, B) are displayed when the power lift is lifting or lowering.

- By pressing key (F2) sub-menu EPC rear will be displayed.

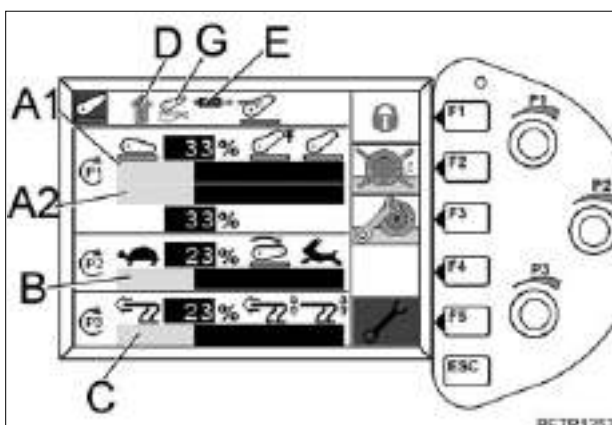

Fig.153

Settings are adjusted by three rotary controls (P1, P2, P3).

- A1 = Lift height limiting
- A2 = Position of the power lift
- P1 = Rotary control lift height limit/position of the power lift
- B = Lowering speed
- P2 = Rotary switch for lowering speed adjustment
- C = Position/traction mix control
- D = Power lift active
- E = Double-acting function active
- P3 = Rotary switch, position-traction mix control
- F1 = Power lift lock ON/OFF
- F2 = Slip control ON/OFF
- F3 = Set slip control
- F4 = No function in this sub-menu
- F5 = Change engaging speed of shock load stabilising
- G = Floating position
- ESC = Return to a higher-level menu

18.2 EPC safety lock



DANGER:

Select 'Stop' to prevent inadvertent movements of the power lift.

When safety lock is active, the power lift does not function.

The safety lock becomes active in any of the following situations:

1. When the ignition is switched on/off.
2. When starting the tractor.
3. During DA operation of the rear power lift.
4. When there is a fault in the electrical circuit.
5. When rear controls have been operated.
6. By connecting or disconnecting an external sensor.

Unlocking the power lift

There are two ways of unlocking the power lift.

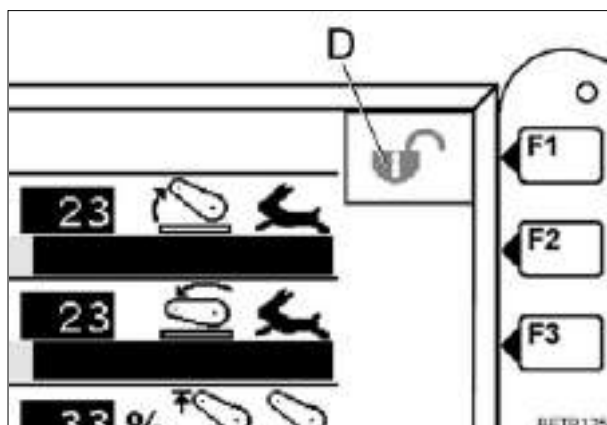

Fig.154

1. With the Vario Terminal.

- By pressing key (F1) the lock can be switched OFF/ON.

Symbol (D) appears.

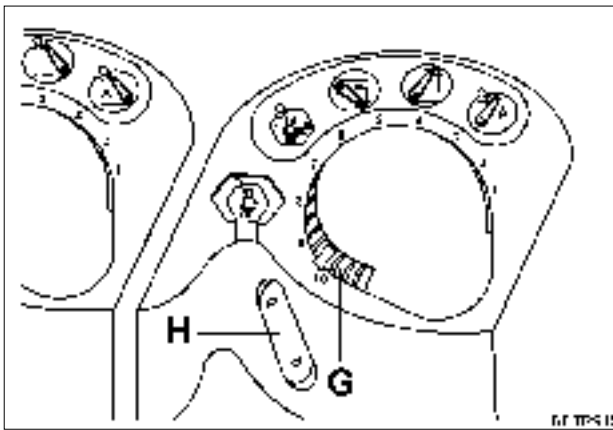

Fig.155

2. Using Quick Lift switch.

- Flick quick lift switch (H) once upwards.

When it is unlocked, the power lift moves to the position selected with the depth control (G).

NOTE:

After unlocking EPC, lifting or lowering speed is reduced until the preset position is attained. Normal speed can be restored immediately by briefly selecting the STOP position.

18.3 Control panel functions

Quick Lift key

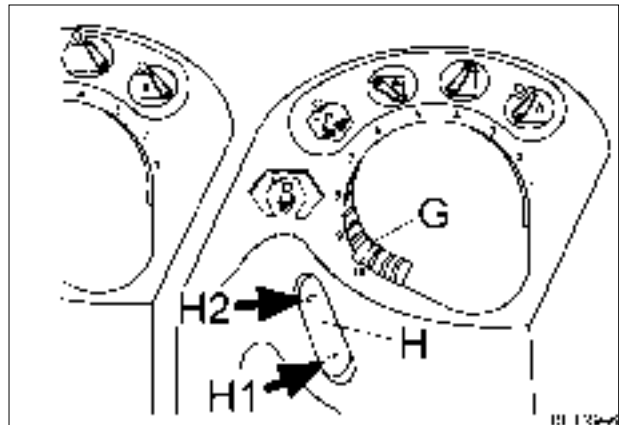

Fig.156

- Stop = Switch (H) in centre position.
LED lights up if the EPC, lift or control are **active**.
Press switch (H) again in the active direction of actuation - the LED goes out.
or at speeds under 0.5 km/h.
Press switch (H) once in the non-active direction of actuation, LED goes out.
- Raise = Controller position (H2) LED lights up.
The working implement is adjusted to the height control value set.
- Control = Controller position (H1) LED lights up.
Implement is set at the value selected with the depth control (G).

Depth control

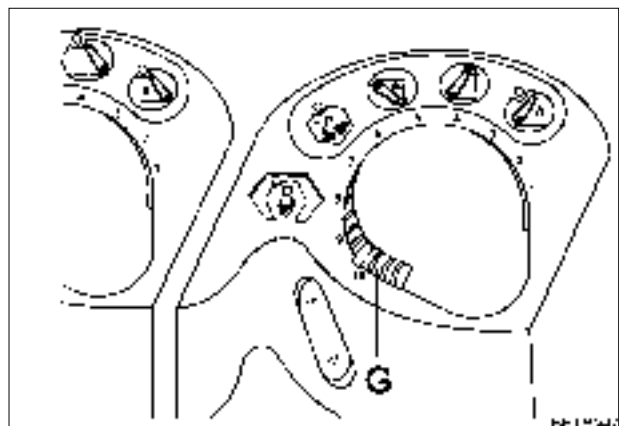

Fig.157

Depth control (G) for setting the working depth.

OPERATION

Direction of rotation for depth control.

- right = Raise
- left = Lowering
- Extreme left = Floating position
- as far as 1 = Neutral

Lift height limiting

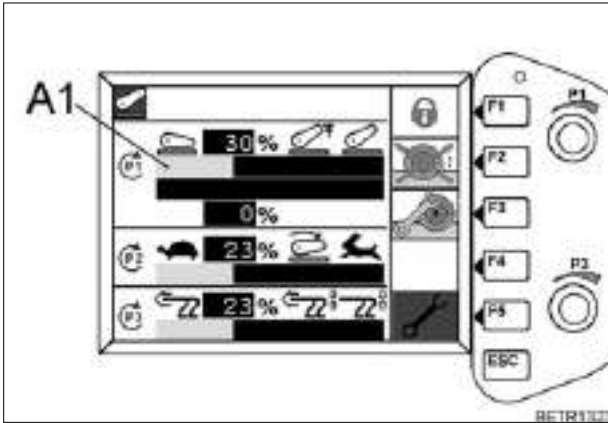

Fig.158

Rotary switch (P1) for selecting maximum lift height.

The lift height can be set steplessly from left to right.

- right = maximum lift.
- left = minimum lift.

Bar indicator (A1) from 30% - 100%.

Position of the power lift

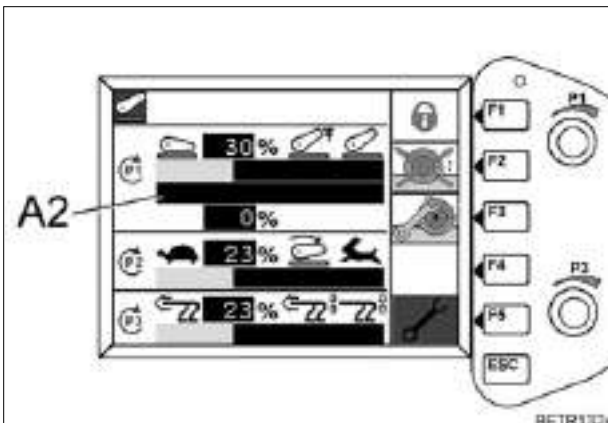

Fig.159

Use rotary switch (P1) to set the position of the power lift.

The position of the power lift can be set steplessly from left to right.

- right = all the way up.
- left = all the way down.

Indicator bar (A2) from 0% - 100%.

Lowering speed

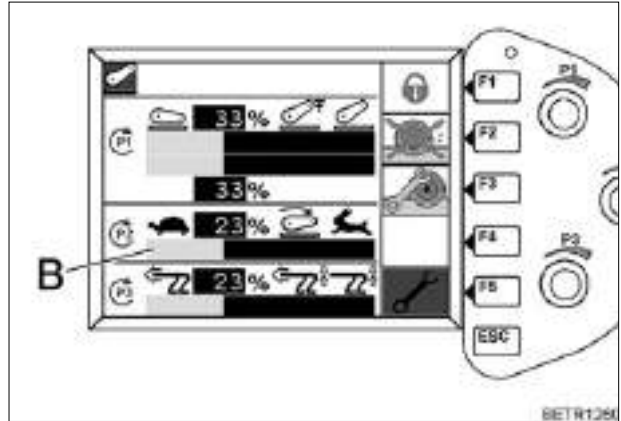

Fig.160

Rotary switch (P2) for selecting the lowering speed.

Positions of bar indicator (B).

- right = Max. lowering speed.
- left = no lowering.

Lowering speed can be adjusted steplessly between the two positions.

Position/traction mix control

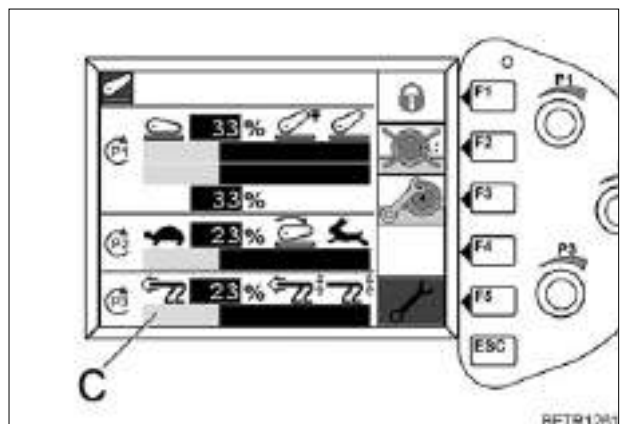

Fig.161

Rotary switch (P3) for setting position and tractive power, or for stepless adjustment of the position/traction ratio.

Positions of bar indicator (C).

- right = Position control (fertiliser spreader).
- left = Traction control (plough).

Mixed control is between position and traction.

Fast feed-in

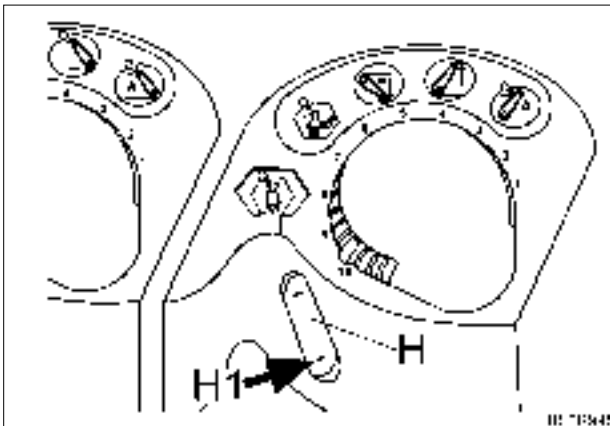

Fig.162

- Quick lift key (H) to 'Control' (H1), LED lights up.



Press key. Implement is lowered to maximum depth (floating position). Release the button, the implement returns to the selected working depth.

External rear controls



Fig.163

Pushbuttons (A) to the left or right of the rear lamp for raising or lowering the lifting gear.

If the safety lock is actuated, External operation is possible at any position of the Quick Lift switch.

18.4 Working with the EPC

Hitching three-point implements

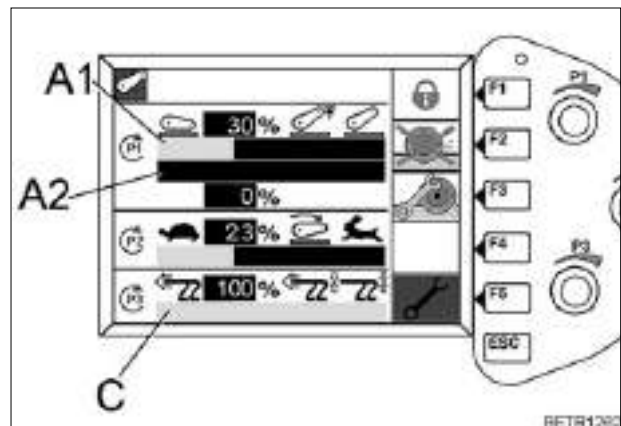

Fig.164

- With rotary switch (P3), set 100% position, bar indicator (C).
- With rotary switch (P1), set 30 % lift height, bar indicator (A1).
- Wait until indicator bar (A2) displays 0%.

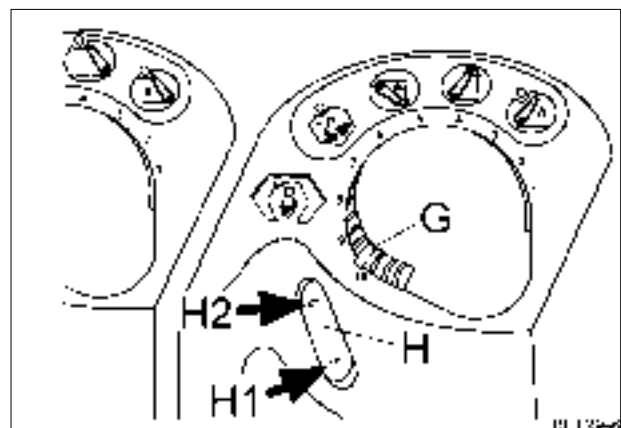

Fig.165

- Quick lift key (H) to 'Control' (H1), LED lights up.
- Lower the lifting arms by turning the depth control (G) to the left. To raise the lifting arms, turn the control to the right.

The upper and lower links are firmly attached to the implement.

- Turn depth control (G) fully to the right or set the quick lift switch (H) to Lift (H2). The implement is raised to the lift height limit (approx. 1/4 of the total lift height).
- By turning Rotary control (P1), the implement can now be raised to the desired lift height.

OPERATION

Unlinking 3-point implements using depth control

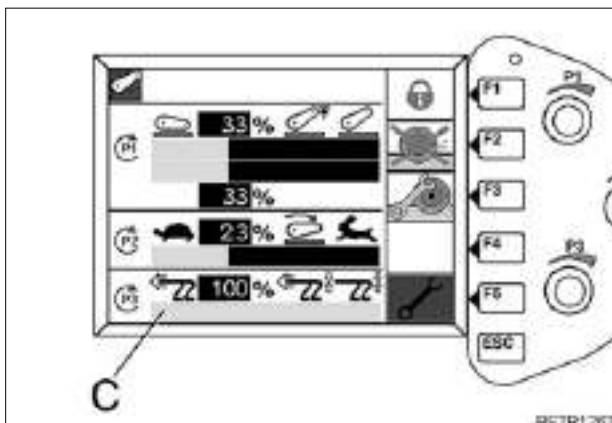

Fig.166

- With rotary switch (P3), set 100% position, bar indicator (C).

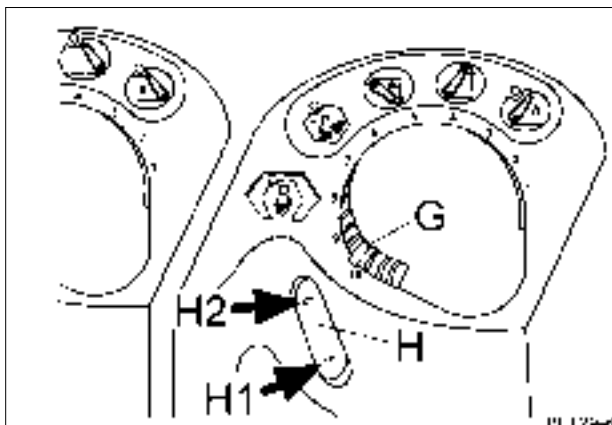

Fig.167

- Turn depth control (G) to completely to the right.
- Quick lift key (H) to 'Control' (H1), LED lights up.
- With depth control (G), lower slowly until there is no load on the top link, then detach, release the catch hooks and fully lower the hydraulics.

Setting the desired transport height

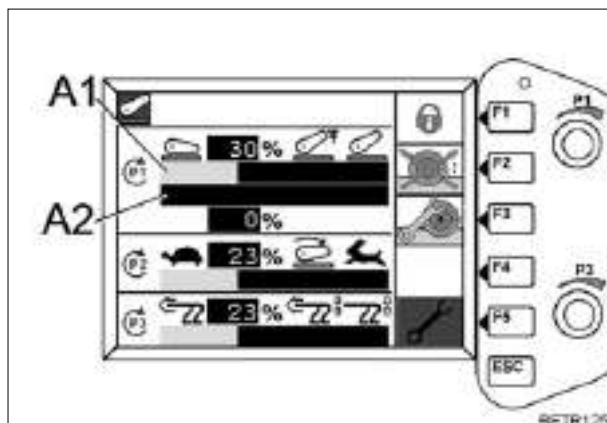

Fig.168

- Lower the implement completely.
- With rotary switch (P1), set 30 % lift height, bar indicator (A1).
- Wait until indicator bar (A2) displays 0%.

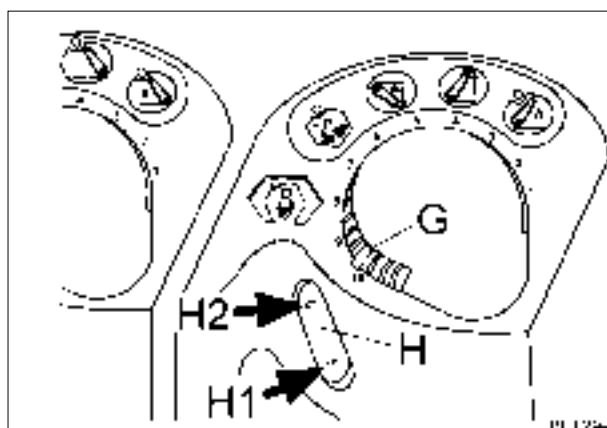

Fig.169

- Quick lift switch (H) to 'Lift' (H2), LED lights up, implement rises approx. 1/4.
- With rotary switch (P1), set the desired transport height.

Road haulage

(Transport lock).

- For road transport, turn depth control (G) fully to the right.

Transport with vibration damping

After raising the implement with the Quick Lift switch, vibrations due to uneven road surfaces are reduced by small movements of the power lift, thus preventing jerking of the tractor. This reduces the mechanical load on tractor and implement, while improving the steerability.

Vibration damping switches on at a speed of about 8 km/h.

The switch-on speed can be changed to any other value.

NOTE:

Vibration damping is only operative if the safety lock is released with the Quick Lift switch in the transport position.

Changing the activation speed of the stabilising system

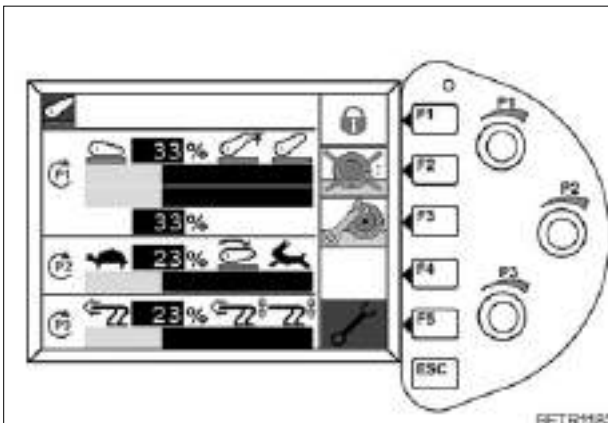

Fig.170

- Press key (F5). The following sub-menu appears.

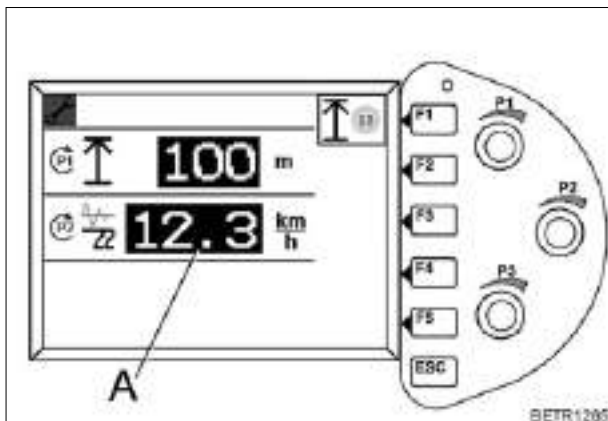

Fig.171

- With rotary switch (P2), set indicator (A) to the desired switch-on speed

Setting range 0 - 30 km/h.

18.5 Electronic slip control

(optional).



CAUTION:

The tractor is equipped with a radar sensor. Do not look directly into the radar sensor. Microwave radiation!

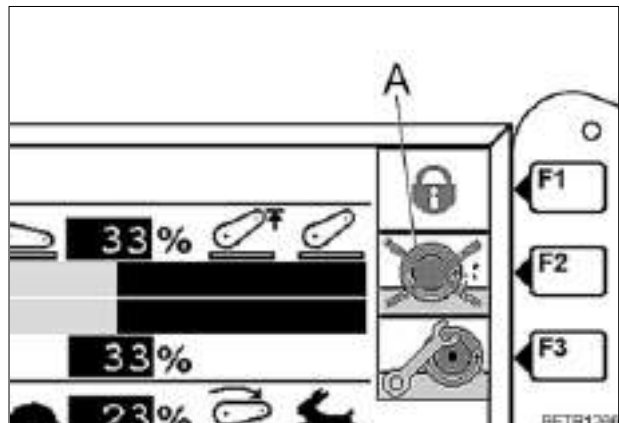

Fig.172

- Turn electronic slip control on and off with the key (F2).

When the slip control is inactive, symbol (A) is shown.

Setting slip control sensitivity

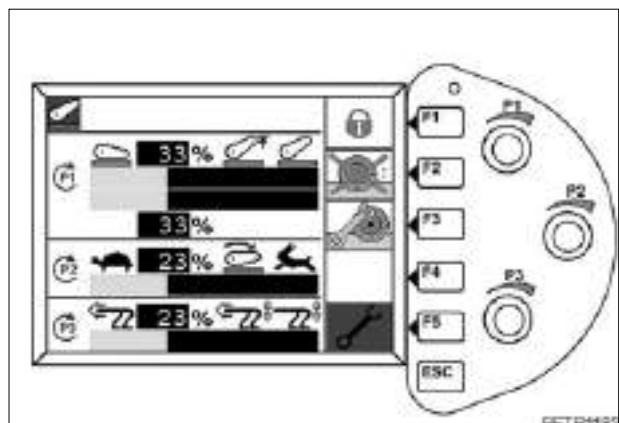

Fig.173

- Set the implement to the desired type of control (position / traction mix control).
- Press key (F3). The following submenu appears.

OPERATION

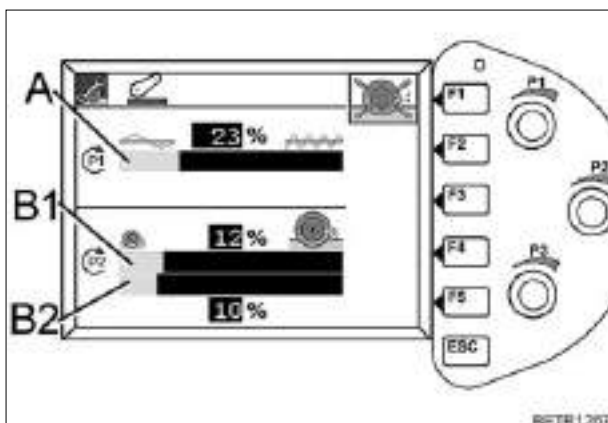

Fig.174

- Turn on slip control with key (F1).
A = Control sensitivity
- B1 = Wheel slip setpoint
Setting range 3% - 60%.
- B2 = Wheel slip actual value
Indication range 0% - 60%.

Setting control sensitivity

- Keep limiting wheel slip with rotary control (P2) until the desired working depth can just be kept.

If an uneven ploughing pattern is formed through too frequent operation of the slip control:

- With the rotary switch (P1), set the control sensitivity.

NOTE:

If the tractor stands still more than 30 seconds, slip control deactivates automatically.

Adjusting the radar sensor

- Measure out and mark an exact distance between 30 m and 100 m on the ground (e.g. 100 m).
- Move the tractor to position the front wheel exactly at the start mark.

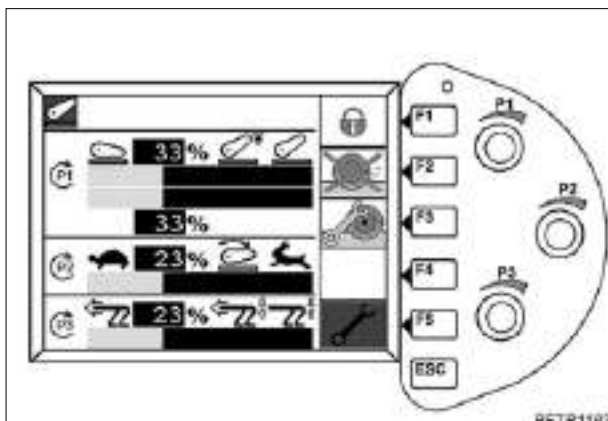

Fig.175

- Press key (F5). The following sub-menu appears.

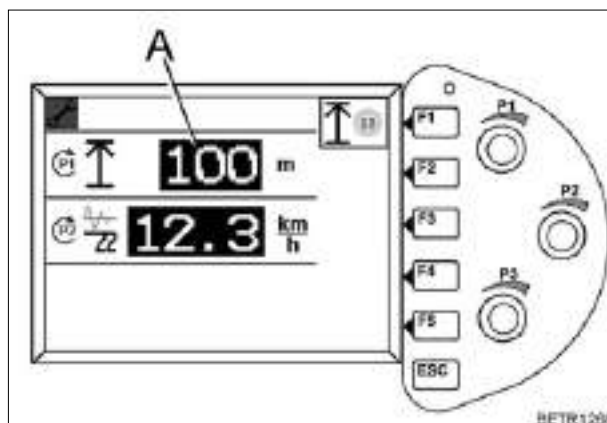

Fig.176

- With rotary control (P1) set on display (A) the measured distance on the ground (e. g. 100 m).
- Press key (F1).

Display changes from 'GO' to 'STOP'.



- Start the tractor off, and stop with the front wheels at the end mark of the measured distance.
- Press key (F1).

If completed successfully, display shows 'GO' again.

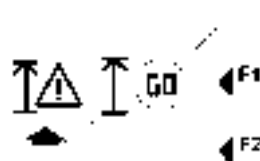
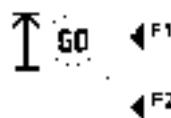

If the warning symbol (arrowed) also appears, the adjustment process must be repeated.

- Check whether the input distance corresponds to the distance marked on the ground.
- Repeat calibration again.

18.6 Electro-hydraulic external control

(optional).

External rear control

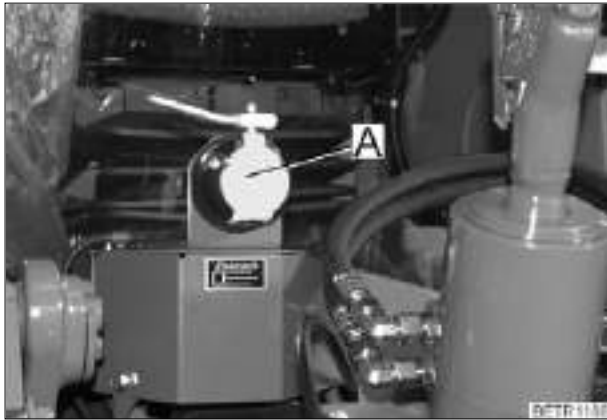

Fig.177

- Connect extension cable from auxiliary transmitter into socket (A).

Setting working depth

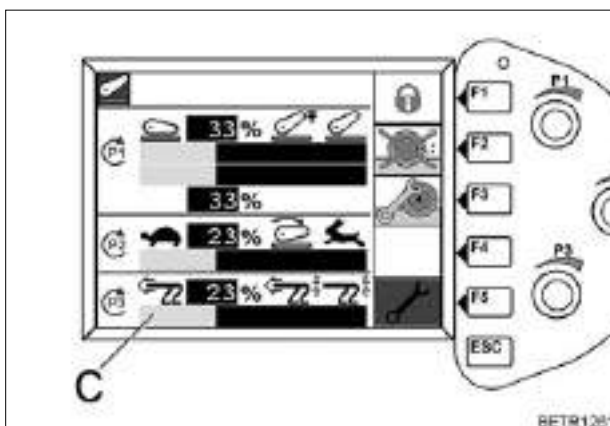

Fig.178

The working depth must be set on level ground.

- With rotary control (P3) set 100% (position control) (indicator bar C).
- Set position sensor on implement in high position with a hand crank.

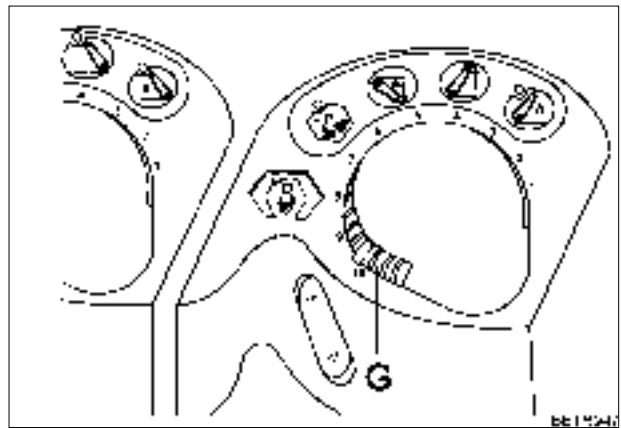

Fig.179

- Start off, and set the working depth with depth control (G).
- Stop the tractor.
- Move the position sensor down until the first lift pulse is set.
- Start working and check the working depth, adjust the sensor so that the depth control (G) reaches the desired working depth at the centre position (position 5).
- If the standard deviations of the implement are too large or too small, adjust the 'traction/position' mix ratio using rotary switch (P3).

OPERATION

18.7 Electronic power lift control / double action operation (EPC/DA)



DANGER:

Lower all implements mounted on front and back.

Before switching to DA operation, disconnect implements on 2nd rear connector (blue) and multi-coupler. Otherwise, undesired movements of the implement, front loader and rear power lift could occur.

When power lift is used for repair work, e.g. changing tyres, the tractor must be propped.

The EPC power lift can be switched to double-acting (DA) mode.

DA mode is then operated directly with the crossgate lever.



Fig.180

Switching from EPC to DA.

- Lower the lifting gear (if an implement is attached).
- Move crossgate lever into floating position (see OPERATION Fig. 183).
- Move the selection lever to **DW** (DA).

Switching back from DA to EPC.

- Lower the lifting gear fully.
- Move crossgate lever to floating position.
- Move the selection lever to **EPC** (EHR).
- Unlocking the EPC (see OPERATION Section 18.2).

Function indicators in DA operation

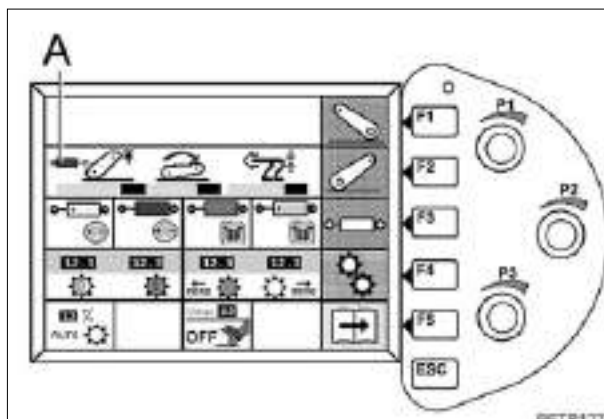

Fig.181

Indicator (A) appears.

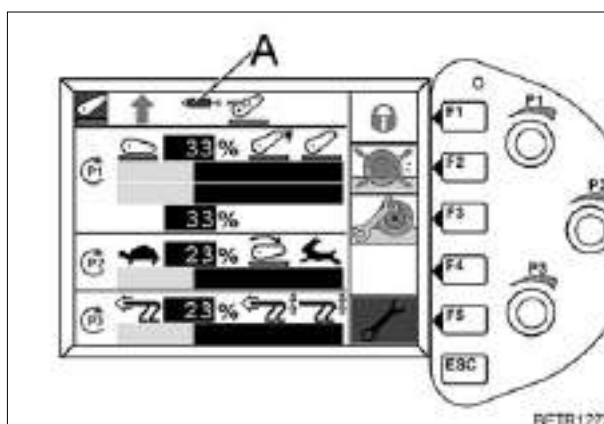

Fig.182

Indicator (A) appears.

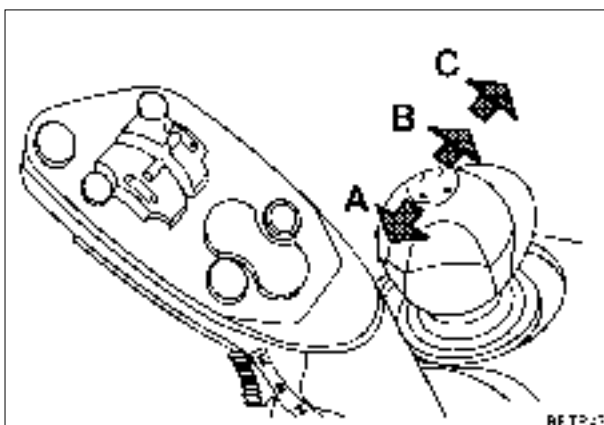

Fig.183

Operating the power lift in DA mode.

- A = Raise
- B = Lowering or exerting pressure
- C = Floating position

NOTE:

Use ground-working implements in 'floating position' only.

18.8 Implement socket

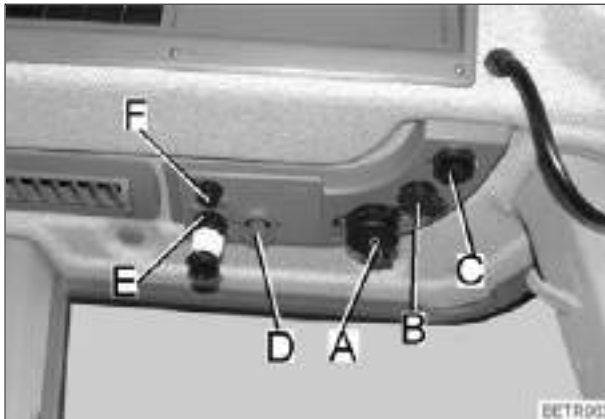

Fig.184

From the implement socket (C) speed signals are passed to the controlling devices, e.g. sprayers, fertiliser spreaders.

Top view of implement socket

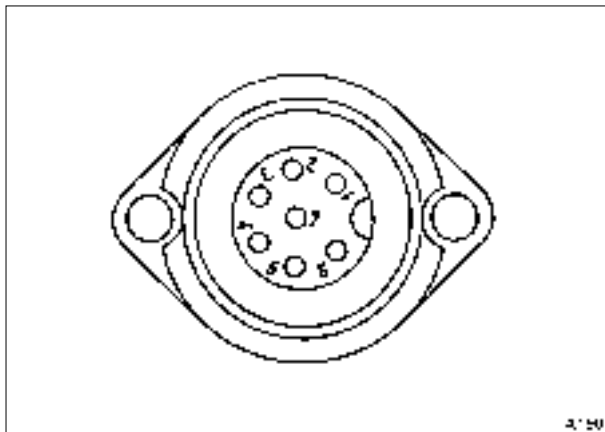

Fig.185

Designations are embossed.

- 1 = Radar signal - if equipped
- 2 = Transmission signal
- 3 = PTO shaft speed
- 4 = Fast lift switch
- 5 = Not in use
- 6 = +Battery voltage (+Ub)
- 7 = Ground

19. Three-point link



DANGER:
Stay clear of the three-point link when in operation - risk of crushing or severing.

19.1 Lower links



DANGER:
For lower link hook locking (see OPERATION Fig. 189) never operate or transport an implement unless both hooks are securely locked.

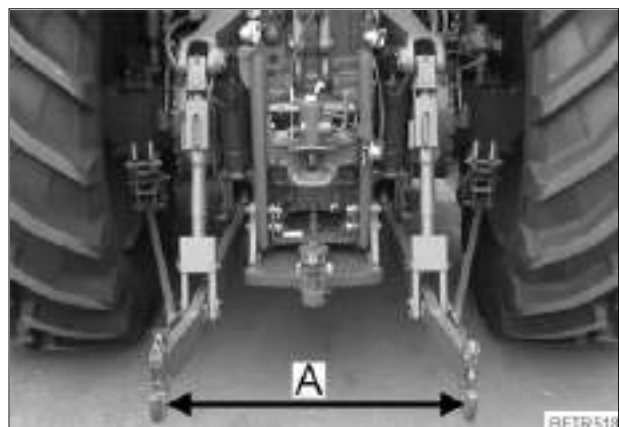

Fig.186

Category II = 825 mm, III = 965 mm distance between the lift support points (A).

NOTE:

Check ball/hook and bolts on the implement side for wear and lubricate well.

Adjusting the lower control link distance

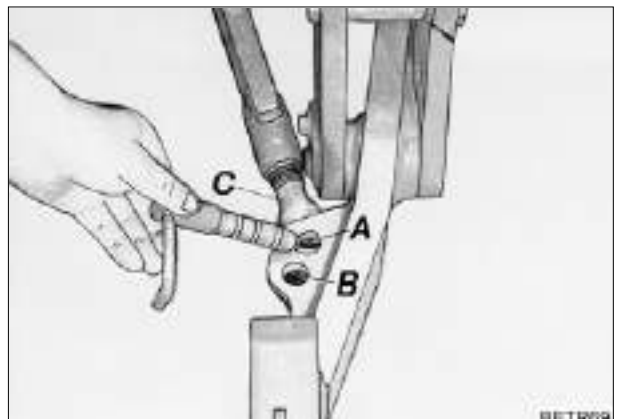

Fig.187

Setting range: Category II - III.

OPERATION

Releasing the side lock.

cat. II. = Put peg into hole (A).

cat. III. = Put peg into hole (B).

Fine adjustments of the lateral stabilisers are obtained by screwing the threaded bolts in or out (C).

Checking:

- Before raising the hitched implement, it must be possible to lock both lateral supports free of play.

IMPORTANT:

Lower links automatically become rigid laterally, when the lifting arm is raised. Too tight a setting will result in clamping in the three-point linkage.

Height-adjustable lower links

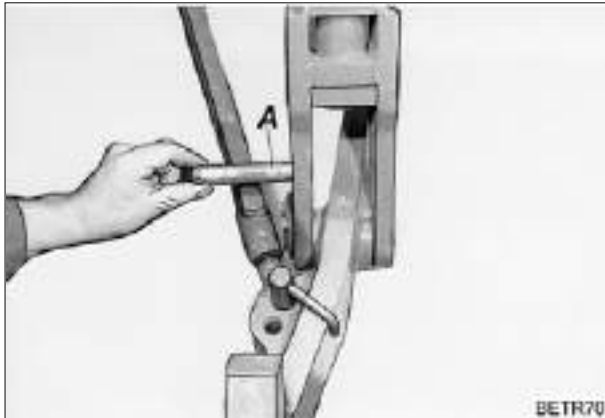

Fig.188

- Insert bolt in lower hole (A).

Required for implements with outrigger wheels and without swing compensation, e.g. for planting machines.

Lower link hook locking

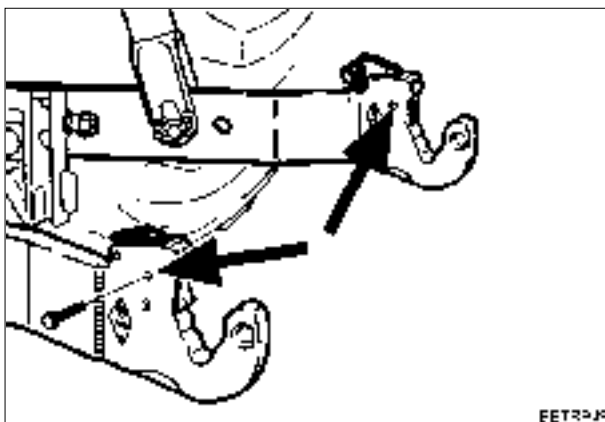

Fig.189

Under particularly heavy operating conditions, secure the lower link hooks against unintentional release (e.g. for logging work).

- Insert bolts (e.g. M 8x50) in the holes (arrowed) and secure with nuts.

19.2 Extendable lifting struts

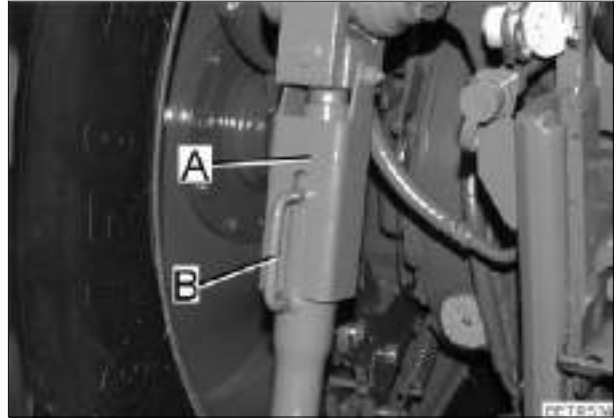

Fig.190

The lifting struts are extendable.

- Fold up the securing clamp (A).
- Adjust the lifting struts by turning handle (B).

NOTE:

It must still be possible for the securing clamp (A) to be folded over button (B).

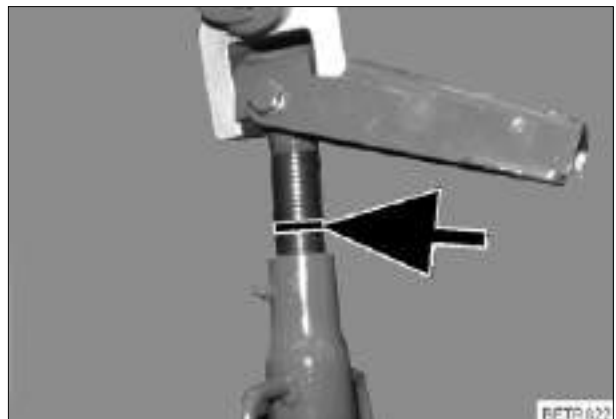

Fig.191

Maximum length is reached when the mark (arrowed) is visible.

19.3 Mechanical side locks

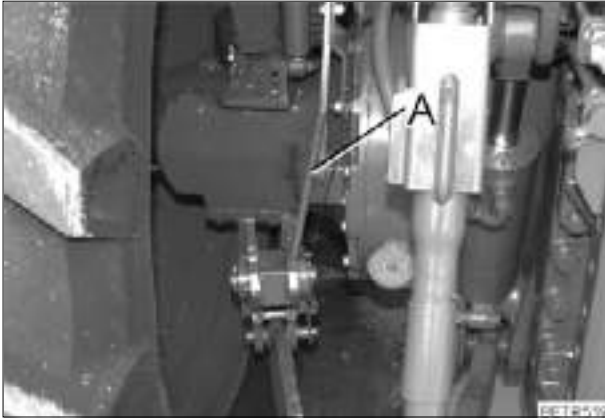

Fig.192

The lower links are locked using the left and right levers (A).

Mounted implement rigid.

- Move lever up.

Mounted implement with lateral movement.

- Move lever down.

19.4 Top link

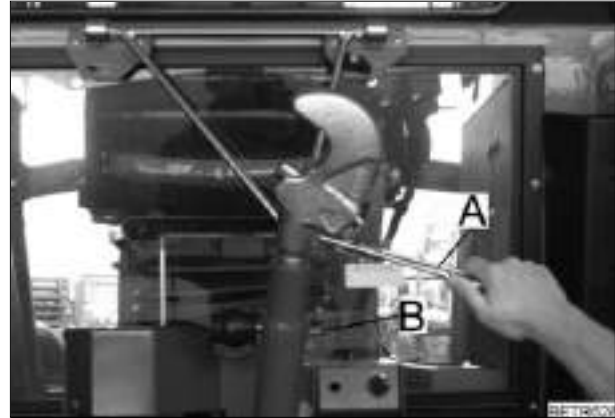

Fig.193

- Adjust length by turning handle (A).

Both threads must be of equal length; securing clamp must clip over peg (B).

Attaching at tractor

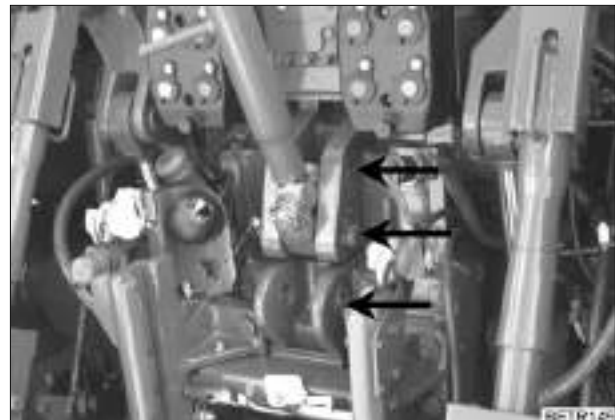

Fig.194

Can be fastened to three bores (for better implement adaptation and for increasing lifting force).

Increased lifting power, reduced lifting height.

- Fit top link into the upper hole.

Reduced lifting power, increased lifting height.

- Fit top link in low position.

20. Front power lift

(optional).



DANGER:

Observe vehicle licencing regulations, for example for permitted axle loads, and the use of counterweights.

For road haulage, observe the maximum distance of 3.5 metres of the implement from the centre of the steering wheel.

When carrying extreme loads e.g. cultivator, only thrust operation is permitted.

If the 3.5 m distance of implement from steering wheel is exceeded, take the appropriate steps to ensure road safety (e.g. at road junctions, use mirrors or an assistant to give hand signals). See the country-specific vehicle licencing regulations.

Distance between lower links:
Category II = 825 mm.

IMPORTANT:

In order to keep the effect of the hydraulic accumulator, do not raise the implement to upper limit. (The load can bounce).

Additional lighting

If the working lamps at the front are hidden by the implement, switch on the additional lights. The front headlamps will then go out.

20.1 Lower links

Swing compensation

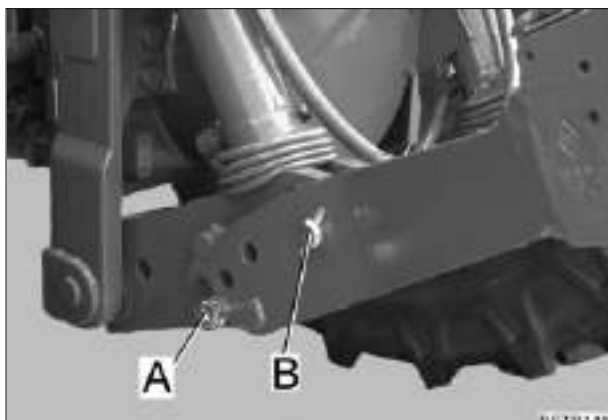

Fig.195

Swing compensation for self-guiding implements.

- Insert bolt (A) in hole as shown, and secure.

Removing the lower links

- Remove bolts (A, B).

NOTE:

If the lower links have been removed, use bolts as the base for the lower links for better assembly. Insert bolt (A) in lower hole.

Lower link, parking position

NOTE:

Always fold up the lower links when not in use.

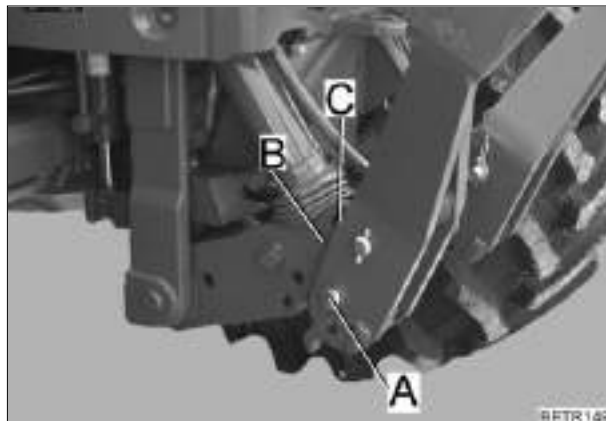

Fig.196

- Insert bolt (A) in hole as shown and secure.

The working range of the front lifting gear can be modified by changing the lower guide point of the lift cylinder.

Lifting cylinder in hole (B)

- larger lifting range of lower link.

Lifting cylinder in hole (C)

- higher lifting power.

20.2 Standard version



DANGER:
 Disconnect rear hydraulic lines
 before opening the shutoff cock!
 Risk of unintentional implement
 movement.
 After finishing front powerlift
 operations, turn stopcock to (see
 OPERATION Fig. 212) OFF.

In the standard version, the front power lift is connected by a fixed pipe to the red or green valve, depending on the the type of equipment. Operating with the control for the corresponding valve (see also OPERATION Section 17.3).

Shutoff cock



Fig.197

OPEN

- Turn lever (A) to the left.

CLOSE

- Turn lever (A) to the right.

DA/SA operation

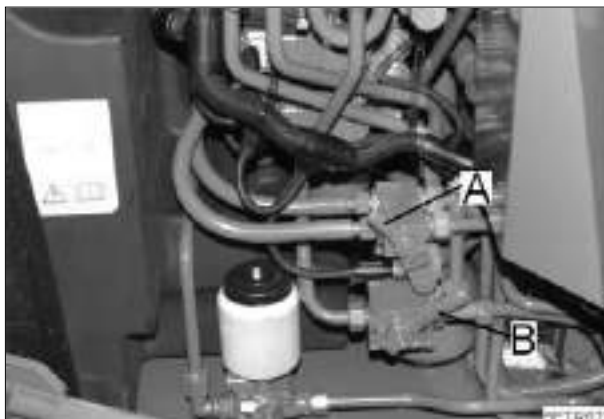

Fig.198

- Turn lever (B) - see sticker.

NOTE:

Only use light implements (e.g. mowers) which are loaded without pushing, in the SA position.

External operation



Fig.199

- The lifting gear can be raised or lowered using buttons (A).

Max. oil quantity 15 l/min.

NOTE:

The external controls only work when the shutoff cock is open.

OPERATION

20.3 Comfort version



DANGER:
Select 'Stop' to prevent undesired movements of the power lift.

Operating console, right side

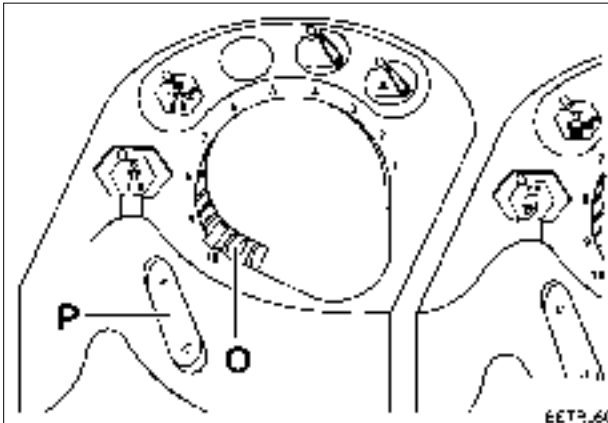

Fig.200

O = Depth control

P = Quick lift key

Floating position



EPC automatic
(also refer to OPERATION
Section 14.1).

Vario terminal

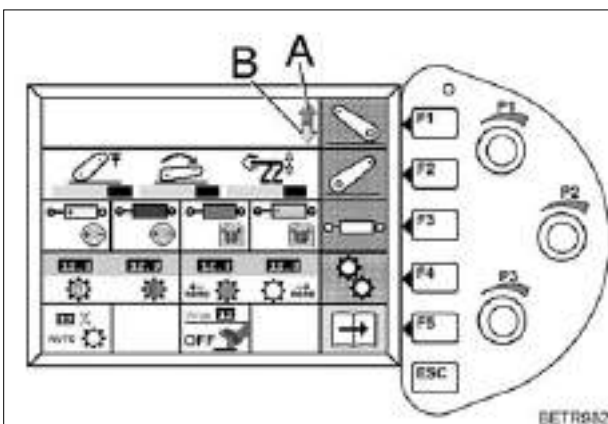

Fig.201

Symbols (A, B) appear when the power lift is lifting or lowering.

- When key (F1) is pressed, the following EPC front sub-menu appears.

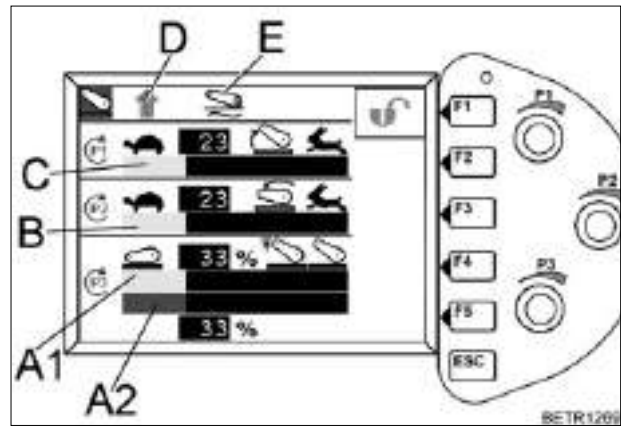

Fig.202

Settings are adjusted by three rotary controls (P1, P2, P3).

A 1 = Lift height limiter

A 2 = Position of the power lift

P3 = Rotary control lift height limit/position of the power lift

B = Lowering speed

P2 = Rotary control for lowering speed

C = Lift speed

D = Power lift active

P3 = Rotary switch for lift speed

E = Power lift in floating position

F1 = Power lift lock ON/OFF

F2 = No function in this sub-menu

F3 = No function in this sub-menu

F4 = No function in this sub-menu

F5 = No function in this sub-menu

ESC = Return to higher-level menu

EPC safety lock

When safety lock is active, the power lift does not function.

The safety lock becomes active in any of the following situations:

1. When ignition is switched OFF/ON.
2. When starting the tractor.
3. When there is a fault in the electrical circuit.
4. After operating the front controls.

Unlocking the front power lift

There are two ways of unlocking the front power lift.

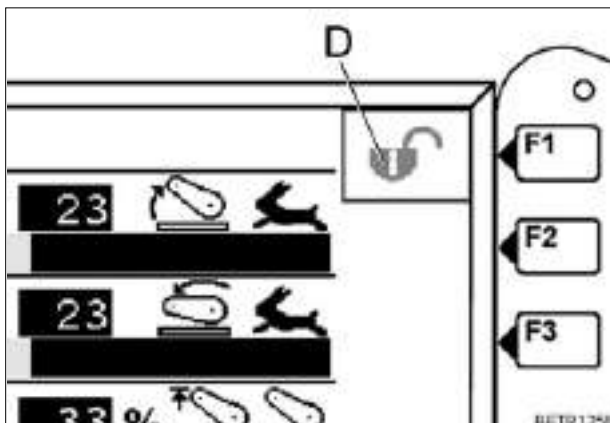

Fig.203

1. With the Vario Terminal.

- By pressing key (F1) the lock can be switched OFF/ON.

Symbol (D) appears.

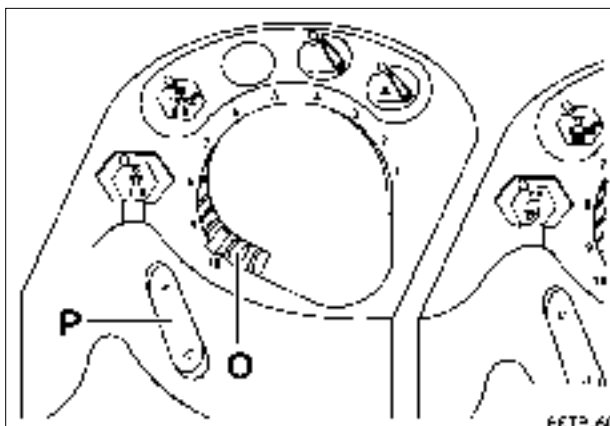

Fig.204

2. Using Quick Lift switch.

- Switch quick lift key (P) once upwards.

As soon as the power lift is unlocked, it moves to the position selected with the depth control (O).

Quick Lift key

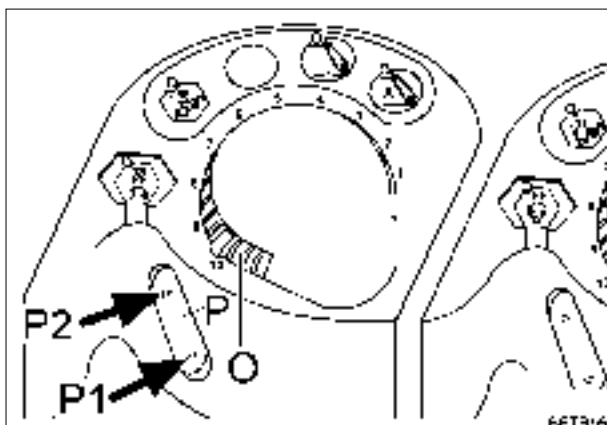

Fig.205

STOP = Switch (P) in centre position.
LED lights up if the EPC, lift or control are **active**.

Press switch (P) again in the active direction of actuation - the LED goes out.

or at speeds under 0.5 km/h.

Press switch (P) once in the non-active direction of actuation - the LED goes out.

Raise = Switch position (P2) LED is lit.

The working implement is adjusted to the height control value set.

Control = Control position (P1) LED lights up.
Implement is set at the value selected with the depth control (G).

NOTE:

In the 'STOP' position, all lifting and lowering movements are stopped at the current positions, except if operated with external front controls. Electronics do not function (no adjustment facility).

OPERATION

Depth control

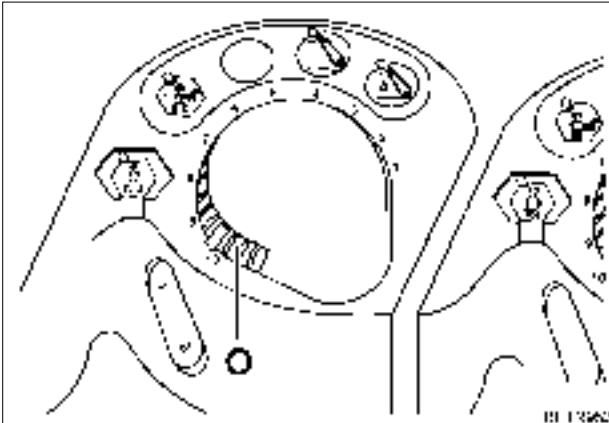

Fig.206

Depth control (O) for setting the working depth.

Direction of rotation for depth control.

right = Raise
left = Lowering

Lift height limiting

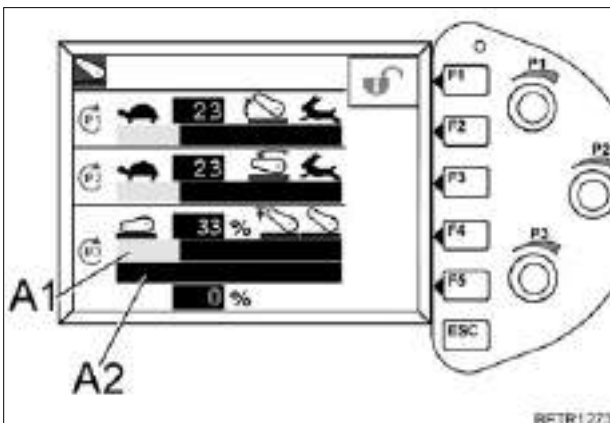

Fig.207

Rotary control (P3) for setting the lift height limit. The lift height limit can be set steplessly from left to right.

right = Maximum lift
left = min. lift

Bar indicator (A1) from 30% - 100%.

Position of the power lift

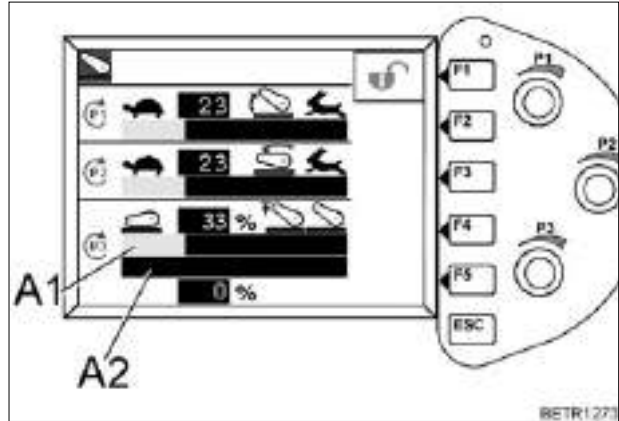

Fig.208

Use rotary control (P3) to set the position of the power lift.

The position of the power lift can be readjusted steplessly from left to right.

right = all the way up.
left = all the way down.

Indicator bar (A2) from 0% - 100%.

Lowering speed

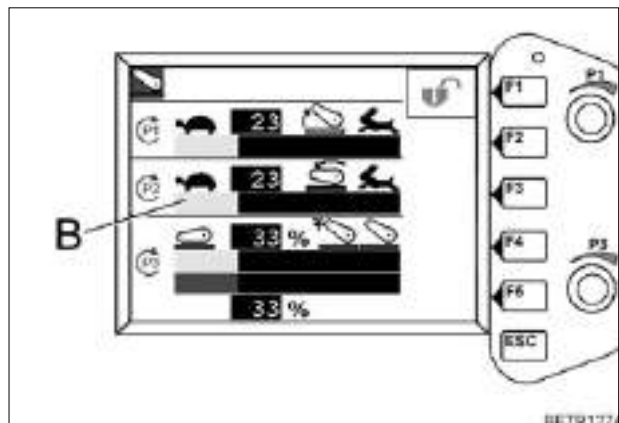

Fig.209

Rotary switch (P2) for selecting the lowering speed.

Positions of bar indicator (B).

right = Max. lowering speed.
left = no lowering.

Lowering speed can be adjusted steplessly between the two positions.

Lift speed

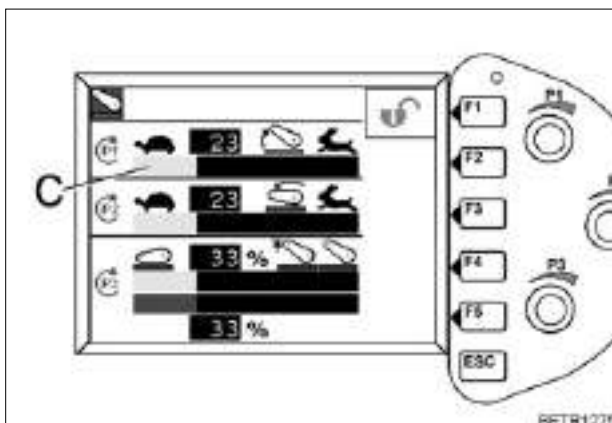

Fig.210

Rotary switch (P1) for setting the lift speed.

Lift speed is controlled electronically and can be adjusted steplessly.

Positions of bar indicator (C).

right = Max. lift speed.
left = No lifting.

Lifting speed can be adjusted steplessly between the two positions.

Front external controls



Fig.211

- The lifting gear can be raised or lowered using buttons (A).

NOTE:

The maximum hydraulic oil flow rate is approx. 30 l/min.

If the safety lock is actuated, External operation is possible at any position of the Quick Lift switch.

DA/SA operation

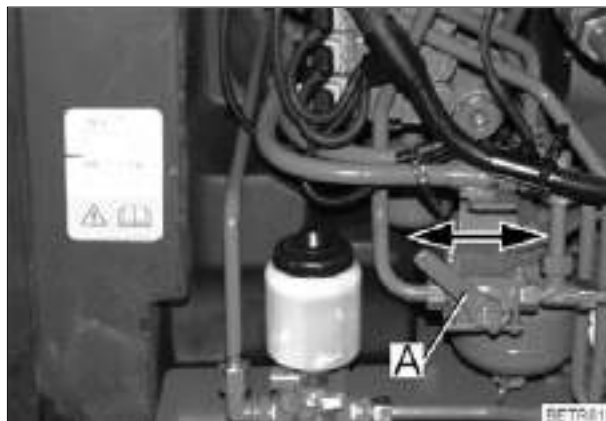

Fig.212

- Turn lever (A) - see label.

NOTE:

Only use light implements (e.g. mowers) which are loaded without pushing, in the SA position.

OPERATION

Floating position

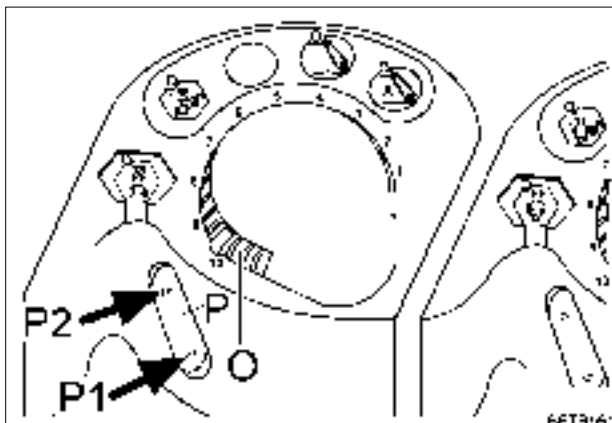

Fig.213

- Quick Lift switch (P) at 'Control' (P1), LED is lit.
- Move implement with depth control (O) to the desired switch-on position.
- Quick Lift switch (P) at 'Raise' (P2), LED is lit.

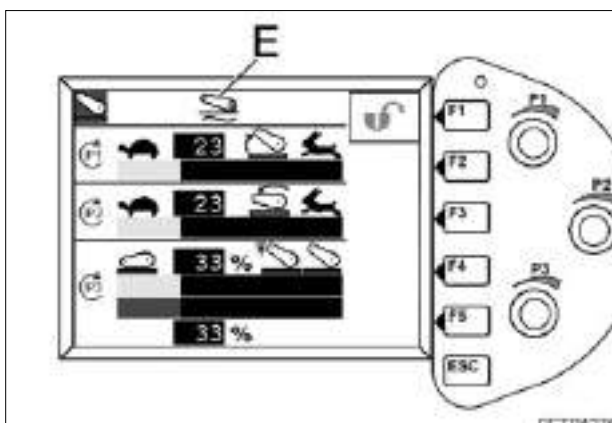

Fig.214



Press button.

- Quick Lift switch at 'Control' (P1) (does not engage), LED is lit.

The power lift lowering movement is controlled, floating position is selected only when the position selected with the depth control is reached. Symbol (E) appears.

Hitching three-point implements

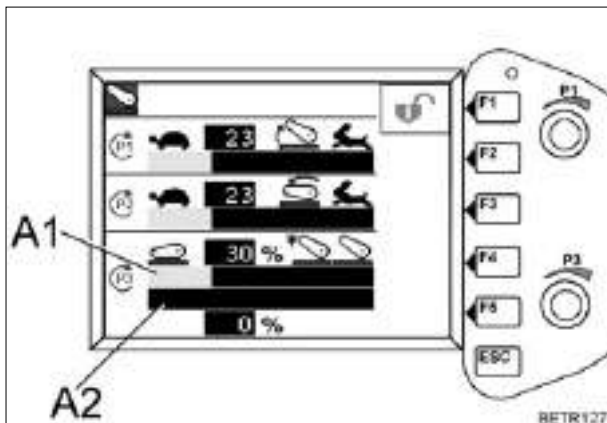

Fig.215

- With rotary switch (P3), set 30 % lift, bar indicator (A1).
- Wait until indicator bar (A2) displays 0%.

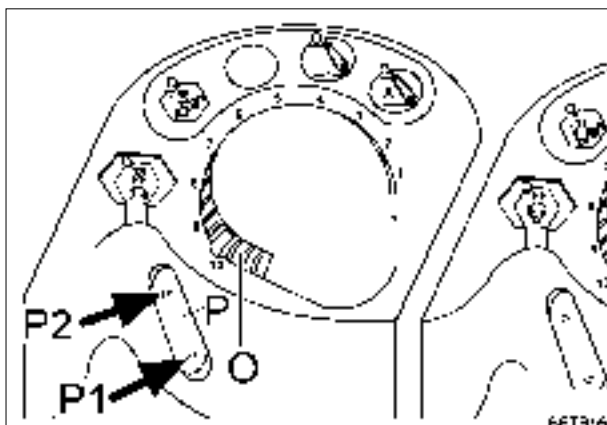

Fig.216

- Quick Lift switch (P) at 'Control' (P1), LED is lit.
- Lower the lifting arms by turning the depth control (O) to the left. To raise the lifting arms, turn the control to the right.

The upper and lower links are firmly attached to the implement.

- Turn depth control (O) to '0' or quick lift switch (P) to 'Lift' (P2) (no lock), LED lights up. The implement is raised to the lift height limit (approx. 1/4 of the total lift height).
- Using rotary switch (P3), the implement can now be raised to the desired height.

Unlinking 3-point implements using depth control

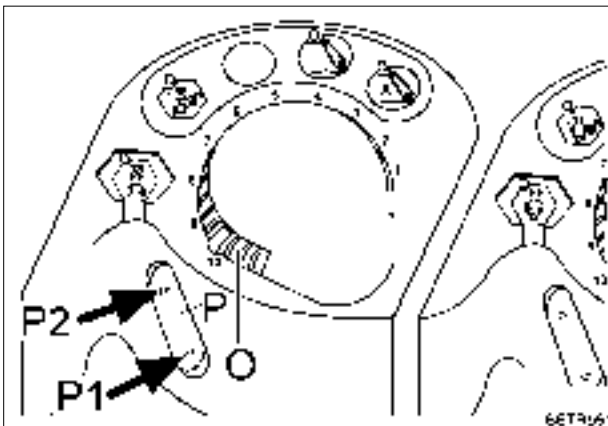

Fig.217

- Turn depth control (O) fully to the right.
- Quick Lift switch (P) at 'Control' (P1), LED is lit.
- With depth control (O), slowly lower the implement till there is no load on the top link, then unhitch the implement.
- Release the catch hook and lower the hydraulics completely.

Setting the desired transport height

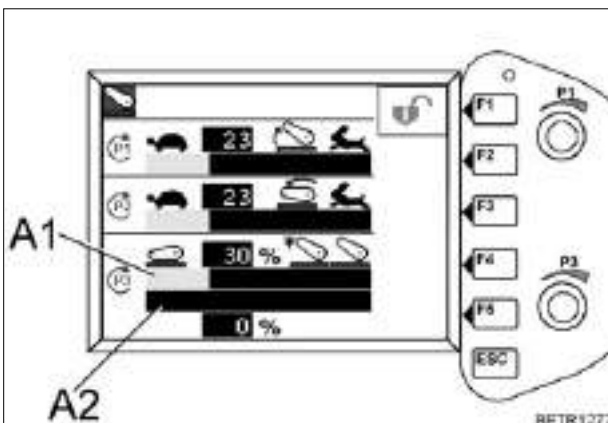

Fig.218

- Lower the implement completely.
- With rotary switch (P3), set 30 % lift, bar indicator (A1).
- Wait until indicator bar (A2) displays 0%.

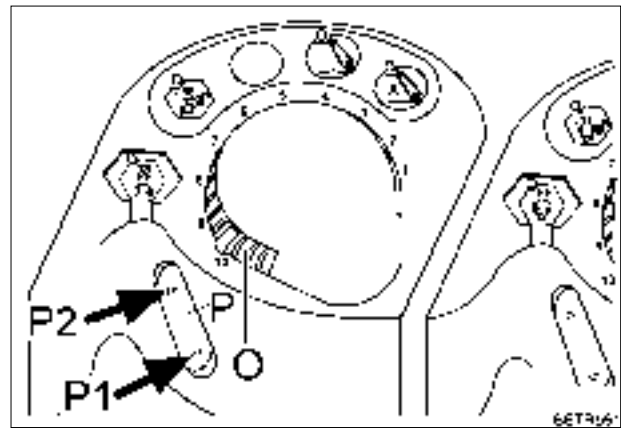

Fig.219

- Quick Lift switch (P) at 'Raise' (P2), LED is lit. The implement is raised by about 1/4 of its lift height.
- Using rotary switch (P3), select the desired transport height.

Road haulage (transport lock).

- For road transport turn depth control (O) fully to the right.

21. Trailing devices



DANGER:

Attach implements and trailers only to the points specified for this purpose. Do not exceed the maximum vertical bearing load on the coupling.

Observe appropriate axle loads and weights, and follow the traffic regulations.

Make sure trailer is correctly attached. Check that the trailer brake system is functioning. Follow the trailer manufacturers instructions!

Carry out regular checks to ensure the trailer hitch is in perfect condition, especially when subjected to heavy loads.

The coupler is a design-approved component and may be used only for its designated purpose.

Use only correct drawbar coupling-pin combinations. Use only the bolts provided.

When converting to a mechanical or automatic coupling, ensure that the coupling cannot slip out of the guide rails unintentionally, by fitting a locking screw into the bottom hole.

We reserve the right to make technical modifications. The details on the rating plate are binding.

The maximum traction vehicle/trailer total weight of 40 tonnes must not be exceeded.

If there are different values on the trailer bracket and trailer hitch rating plates, the lower value is the definitive value.

21.1 Calculation of trailer weights

Diagram of permissible trailer weight

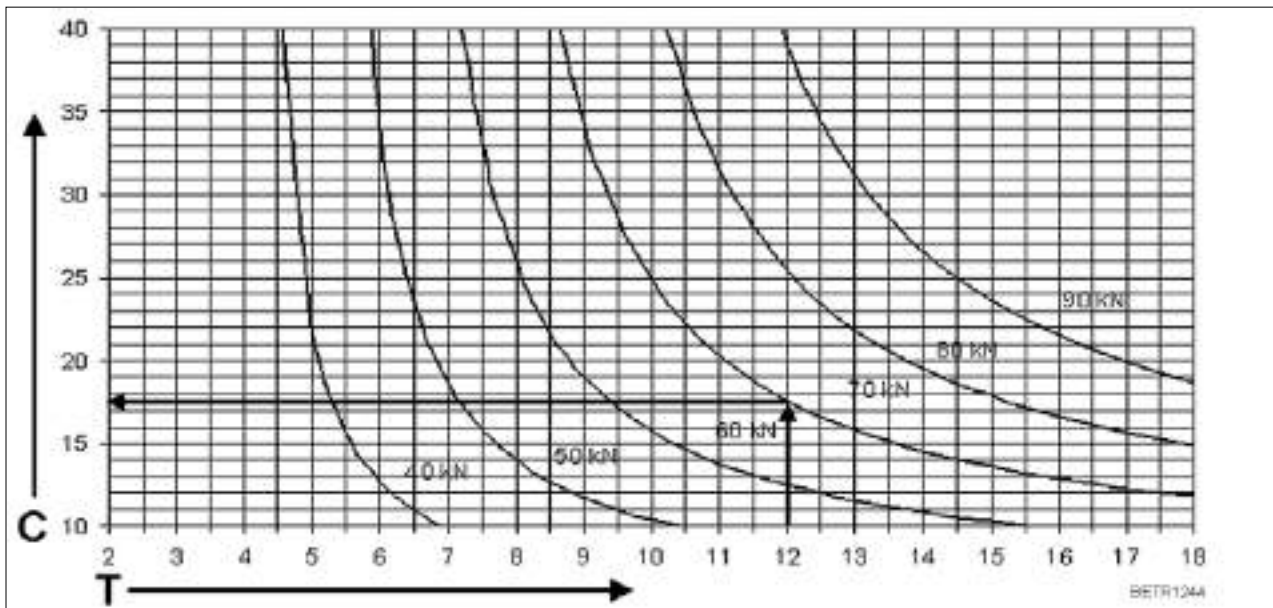

Fig.220

Calculating the permissible trailer weight

$C = T \times D : (T - D)$ Example: $12 \times 70 : (12 - 70) = 17.6$

$Dt = D : 9.81$ Example: $70 : 9.81 = 7.13$

C = Permissible trailer weight (tonnes)

T = Weight of tractor vehicle (tonnes)

D = D-value (kN)

21.2 Trailer bracket

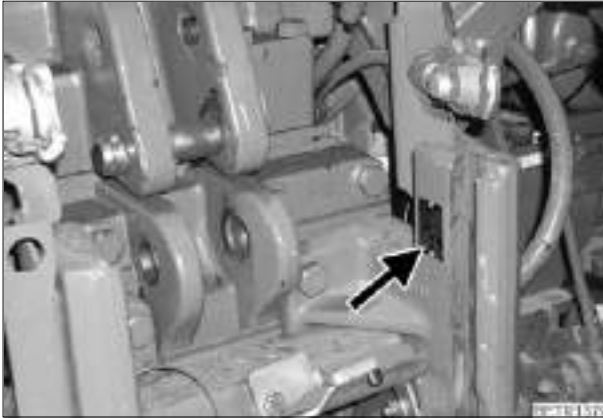

Fig.221

21.3 Hitching a trailer manually

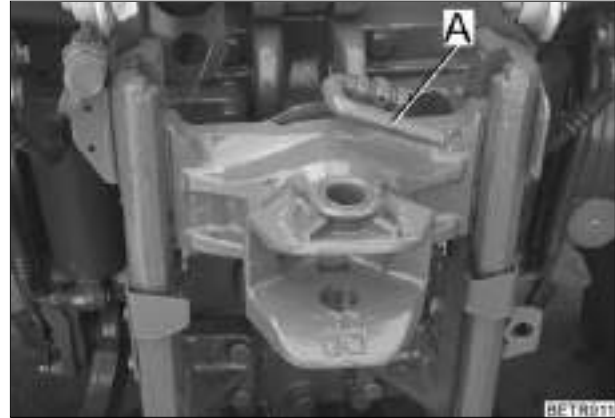

Fig.223

AGCO GmbH & Co. OHG, Anhängerkop. Typ AT-029		
M 4883		
Verwendbar nur an Kfz nach § 43 Abs. 4 StVZO		
	zul. Wert	max. zul. Stützlast
Anhängervorrichtung in Gleitschiene	80,3 kN	2000 kg
Zugzapfen	25,2 kN	2000 kg
Zugpendel	7,8 kN	2000 kg
Kuppungskugel 50	65,2 kN	2700 kg

Fig.222

Observe maximum permissible supporting load and trailer load. (See rating plate.)

Moving the hitch coupling.

- Raise handle (A) and move the coupling.

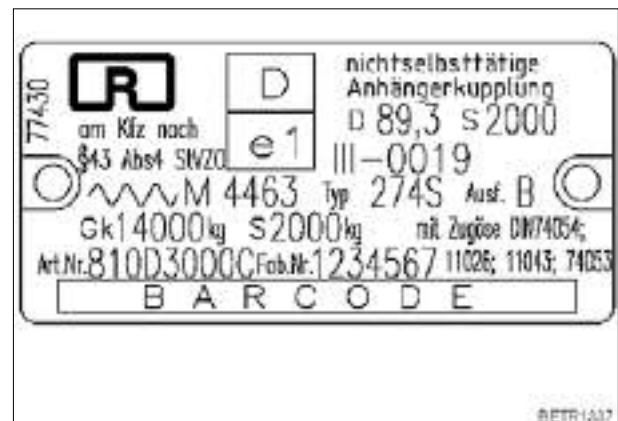

Fig.224

Observe maximum permissible supporting load and trailer load. (See rating plate.)

OPERATION

21.4 Automatic trailer coupling

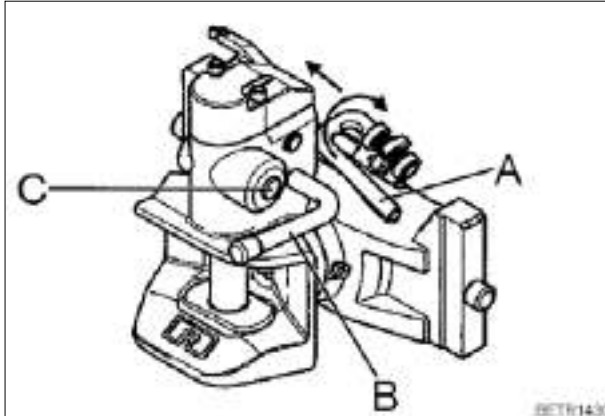

Fig.225

Moving the hitch coupling.

- Turn handle (A) upwards and press to the left.
- Bring trailer hitch to the desired height.
- Hold trailer hitch in floating position to allow the locking bolt to lock in place; at the same time turn handle (A) downwards and press to the right.



DANGER:

In secured position, handle (A) should only be able to be pressed approx. 4 mm towards the opening.

Operating the trailer hitch.

- Press handle (B) upwards until it locks.
- Control stud (C).



DANGER:

Control stud (C) should not protrude from the control sleeve after coupling.

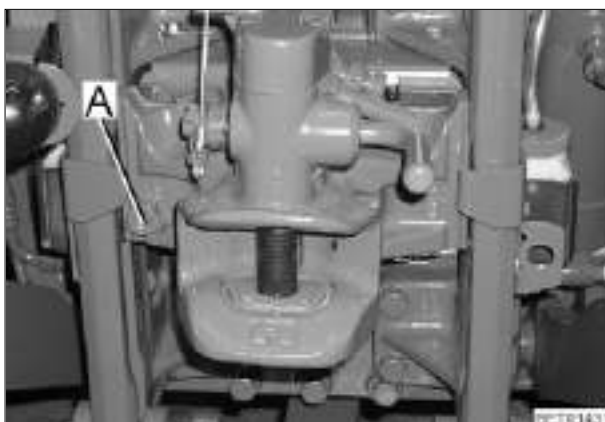

Fig.226

Detaching the hitch coupling.

- Demount remote control cable.
- Pull pin (A).
- Slide the coupling downward and out of the guide rails.

Cylindrical pin version

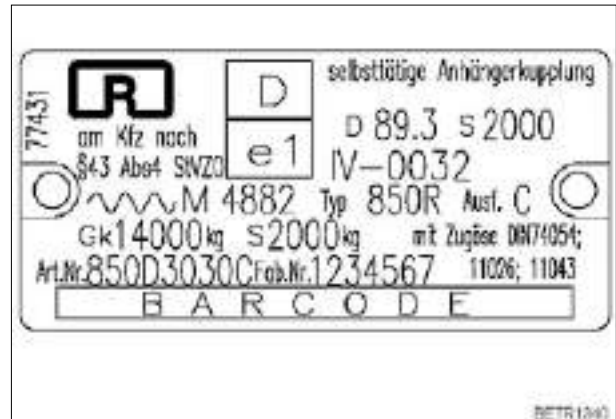

Fig.227

Observe maximum permissible supporting load and trailer load. (See rating plate.)

Version with crowned bolt

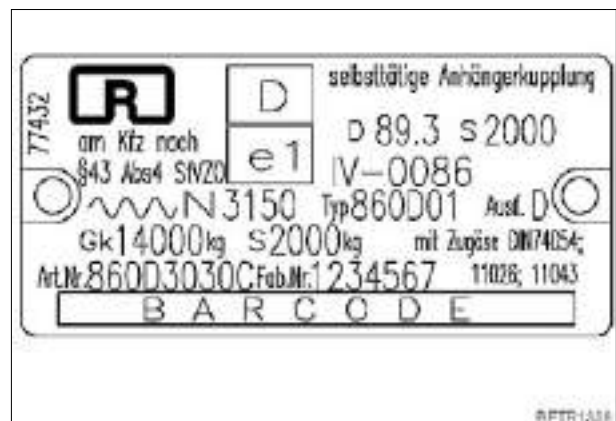

Fig.228

Observe maximum permissible supporting load and trailer load. (See rating plate.)

Remote control

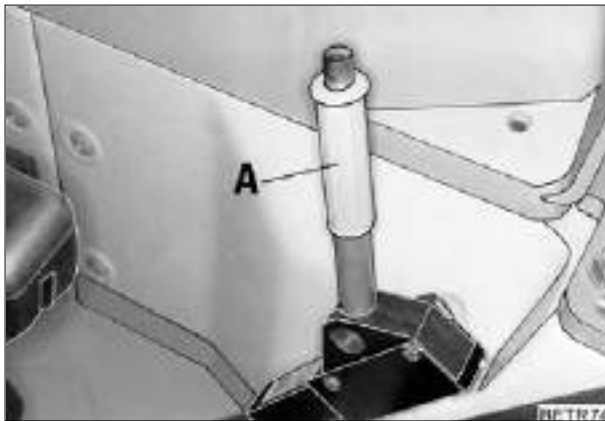

Fig.229

- The hitch coupling can be operated from the driving seat using hand lever (A).

21.5 Ball coupling, drawbar, piton fix

(optional).

Ball coupling

NOTE:

The use of ball coupling when travelling on the public highway is only permitted if this is entered in the vehicle documents.

The trailer must be equipped with a height-adjustable support.

Ball coupling

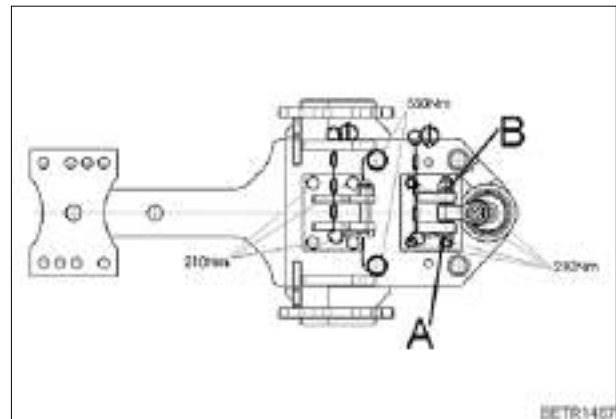

Fig.230

After coupling, secure locking clamp with bolt (A), fit safety lock (B).

Ball coupling height adjustable

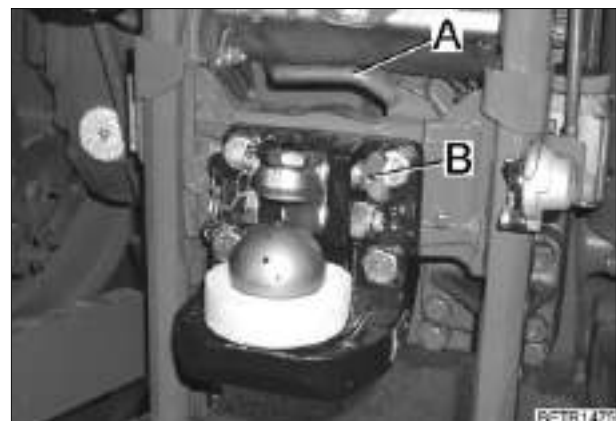

Fig.231

Moving the hitch coupling.

- Press handle (A) upwards and to the right.
- Bring trailer hitch to the desired height.
- Hold trailer hitch in floating position to allow the locking bolt to lock in place; at the press handle (A) to the left.
- After coupling, secure locking clamp with bolt (A), fit cotter pin (B).

OPERATION



DANGER:
In secured position, handle (A) should only be able to be pressed approx. 4 mm towards the opening.

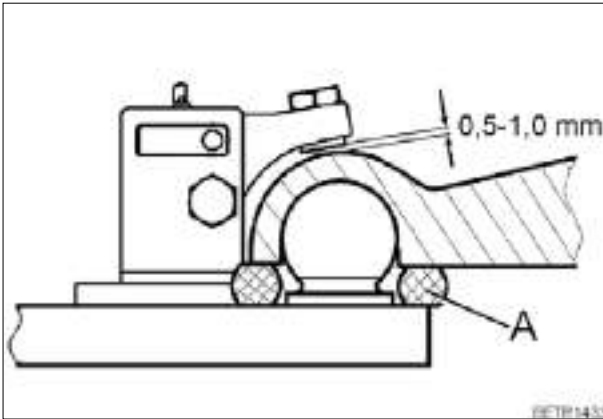

Fig.232

To reduce wear, make sure the foam ring (A) is fitted.

The permissible vertical play (0.5 mm - 1.0 mm) can be set with the locking clamp.

To reduce wear, lubricate the contact surfaces of the ball coupling and hitch mechanism regularly. After operation, cover ball with cap.

Ball coupling



Fig.233

Observe maximum permissible supporting load and trailer load. (See rating plate.)

Ball coupling height adjustable

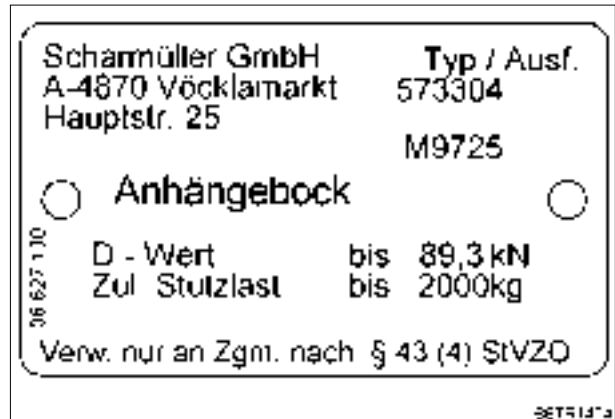

Fig.234

Observe maximum permissible supporting load and trailer load. (See rating plate.)

Ball coupling height adjustable

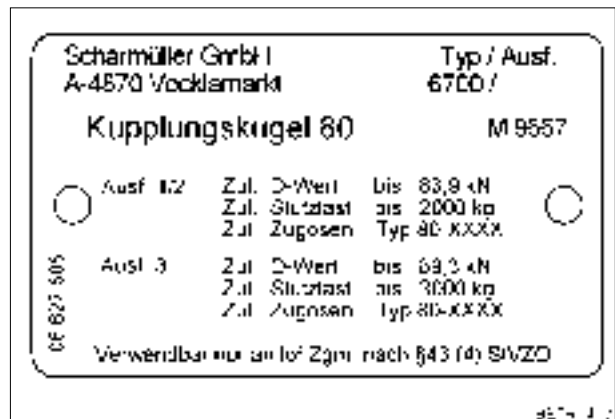

Fig.235

Observe maximum permissible supporting load and trailer load. (See rating plate.)

Draw bar

NOTE:

The use of a drawbar is recommended for implements only.

Due to the excessive play, not suitable as a trailer hitch on public roads.

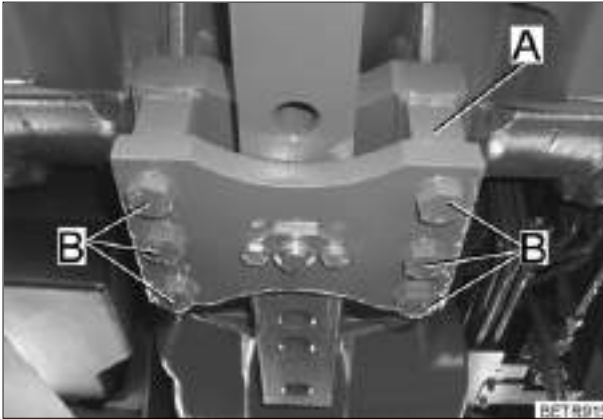

Fig.236

When the bearing bracket (A) is mounted, tighten screws (B) with 580 Nm.



Fig.237

The pull rod can be inserted in different holes. Unscrew safety device. Remove pin (A).

Maximum carrying power (supporting load)

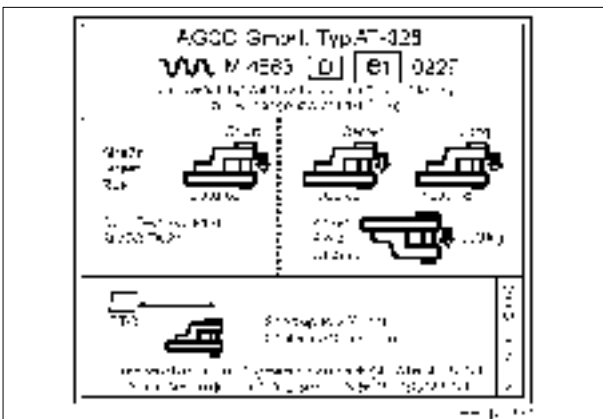

Fig.238

Do not exceed the maximum permissible vertical load and position on public roads (see model plate).

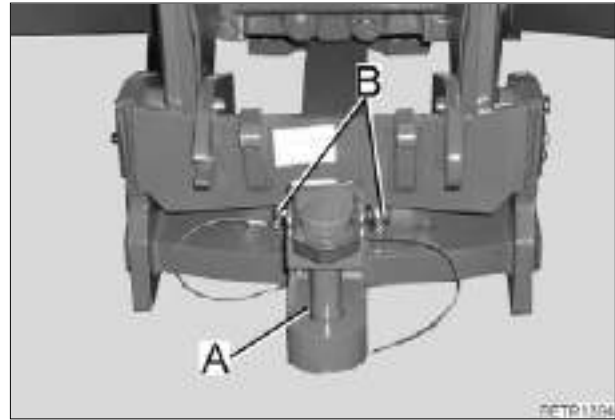

Fig.239

- The bar travel to the left or right can be moved and/or fully opened by removing both bolts (B).
- Coupler height can be adjusted by inverting the drawbar (A).

NOTE:

On public roads, lock the drawbar with with pin (B).

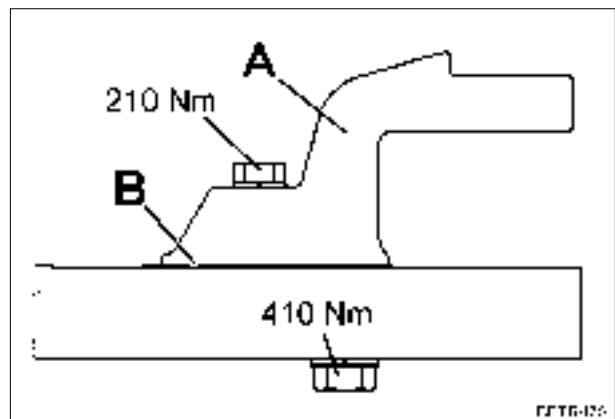

Fig.240

If coupling jaw (A) has been removed, mount the intermediate panel (B) if attaching it again.

Observe the specified torques.

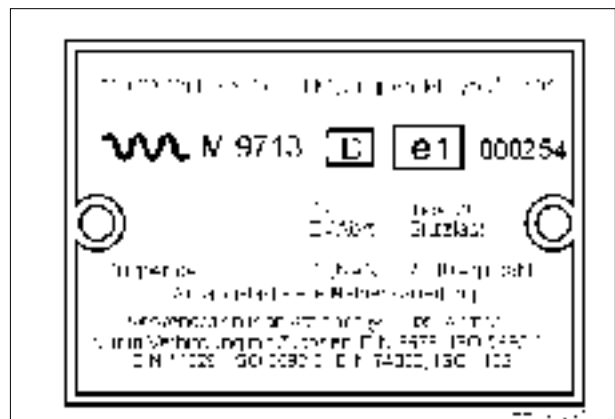

Fig.241

Observe maximum permissible supporting load and trailer load. (See rating plate.)

OPERATION

Piton fix

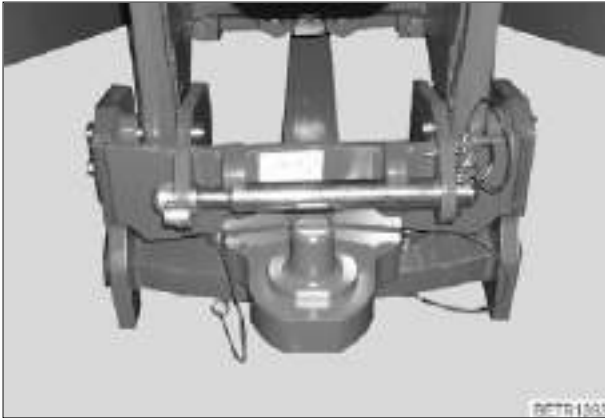

Fig.242

NOTE:

The trailer must be equipped with a height-adjustable support.

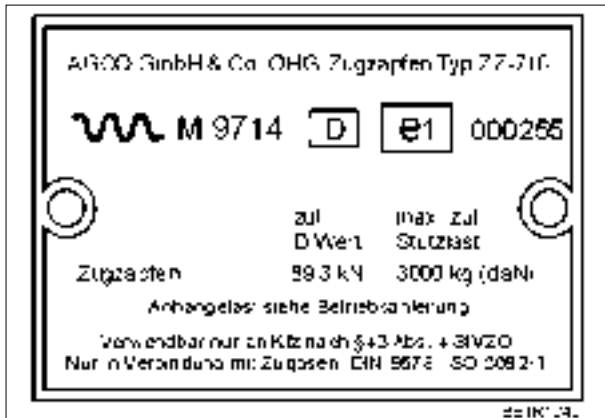

Fig.243

Observe maximum permissible supporting load and trailer load. (See rating plate.)

21.6 Hydraulic trailer hitch

(optional).



DANGER:

Risk of serious injury in the area around the three-point link and lifting rods!

When coupling or uncoupling, release the trailer and/or tractor brakes.

Tractor or trailer may move backwards or forwards. Never stand behind or in front of either one of them. Danger of crushing!

Lock of hitch hook must snap in.

NOTE:

The use of a hydraulic automatic coupling on the road is permissible only if an appropriate entry has been made in the vehicle documents.

Observe safety and operating instructions (see OPERATION Section 17.8).

Operating

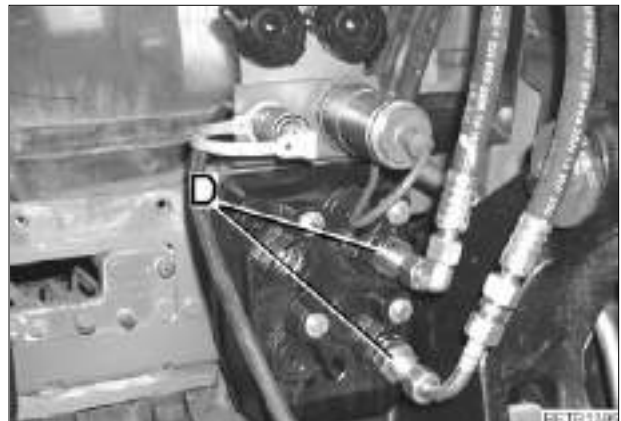

Fig.244

- Connect hydraulic lines to the desired hydraulic connection at the rear, e.g. green valve (D).

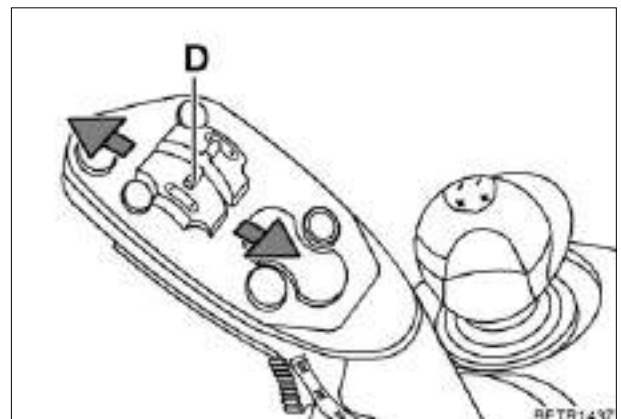

Fig.245

- Lift/lower hydraulic trailer hitch with key (D).

Lowering

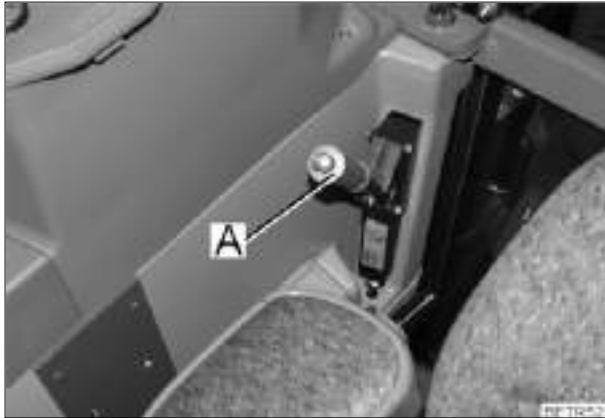

Fig.246

- Before lowering, release lock with lever (A).
- Lower hitch hook.

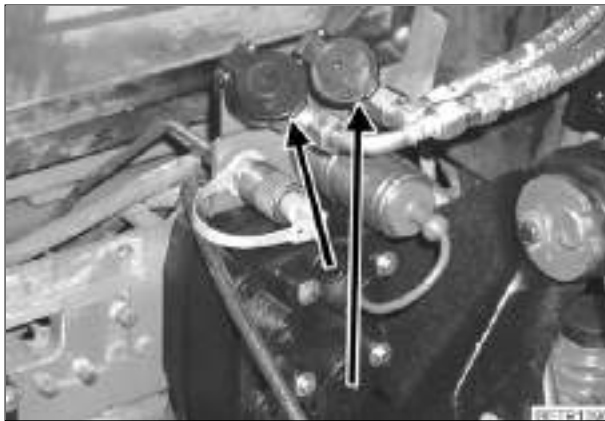

Fig.247

- Lock the hydraulic trailer hitch into parking position (arrowed) after finishing work to allow other use of the hydraulic connection.

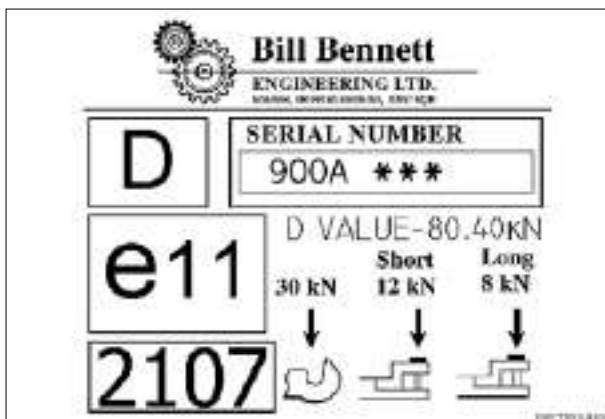

Fig.248

Observe maximum permissible supporting load and trailer load. (See rating plate.)

Maintenance

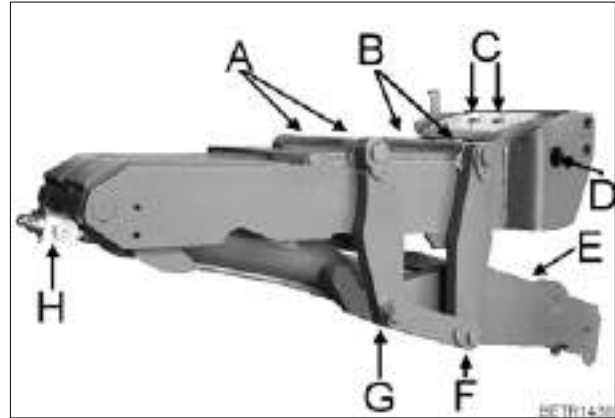

Fig.249

Lubricate hydraulic trailer hitch every 100 operating hours at the lubrication points (arrowed).

Lubrication points

- A = lower hitch, 2 lubrication points.
- B = lower hitch, 2 lubrication points.
- C = unscrew cover, 2 lubrication points.
- D = to the left and right of the catch hook, 2 lubrication points.
- E = on hitch hook, 1 lubrication point.
- F = underside of hitch, 4 lubrication points.
- G = underside of hitch, 4 lubrication points.
- H = unscrew cover, 1 lubrication point.

OPERATION

22. Compressed air system



DANGER:

Make sure trailer is correctly attached. For trailers with air brakes, start driving only the 3 bar indicators are visible on display (C) and there are no warning messages!

Observe trailer manufacturer's instructions.

Whenever towing trailers equipped with air brakes, do not use independent wheel brakes (lock the brake pedals)!

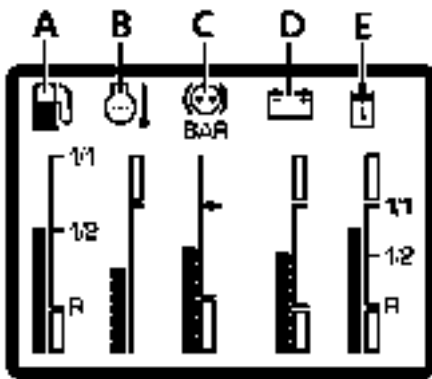

Fig.250

Correct operating pressure is reached if the 6 pressure indicator bars (C) are shown.

Insufficient operating pressure is indicated by a flashing bar indicator.

22.1 Operating

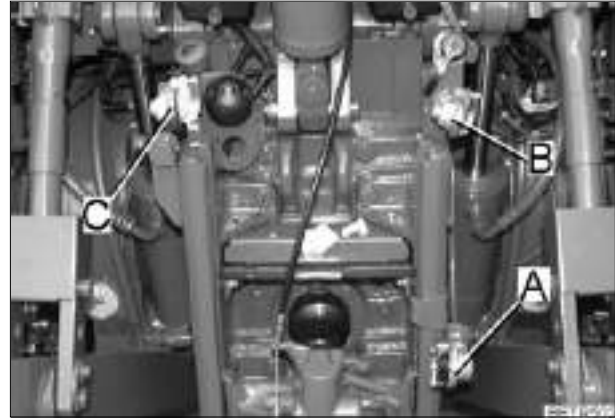

Fig.251

- A = 'Black' coupling head
Connector for single-line system.
 - B = 'red' coupling head
Dual-line system supply.
 - C = 'Yellow' coupling head
Dual-line system, brakes.
- After uncoupling, seal the openings with the dust caps.

Antifreeze pump/tank

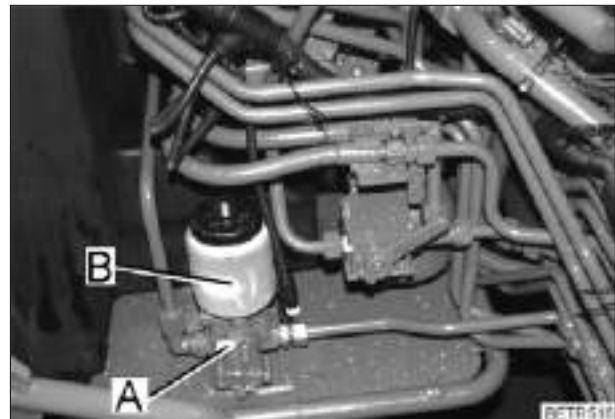

Fig.252

If frost is expected:

- Set antifreeze pump lever (A) to I = open.
- Fill antifreeze tank (B) with ethyl alcohol (X 902.015.003).

At the end of the cold season:

- Set lever to 0 = closed.

Filling tyres

- Connect the supplied tyre inflating hose to red coupling head.

IMPORTANT:

Regularly check pressure which can rise to about 8.1 bar.

22.2 Maintenance

Testing the compressed-air system for leakages

To be carried out weekly with stopped engine and a full air tank: display on dash panel must maintain unchanged indication for at least 3 minutes.

Draining condensation water from the air bottle

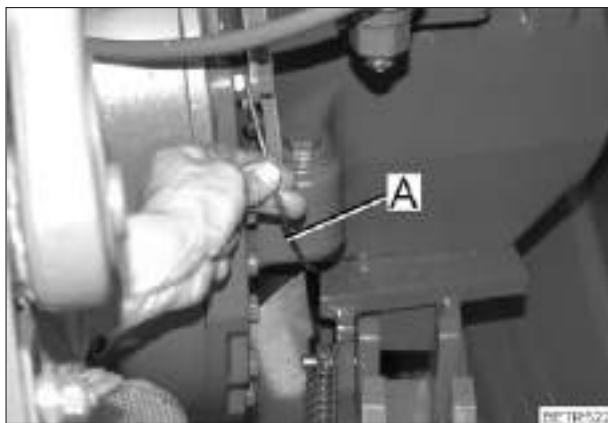

Fig.253

- Press pin at the bottom of the tank daily, or pull the cable (A) and drain condensate.

23. Additional ballasting



DANGER:

Always make sure there is sufficient weight on the front axle when using rear-mounted implements. To maintain brake effectiveness and steerability, the front axle must be loaded with at least 20% of the unladen weight of the tractor.

Always fit weights in the fixing positions provided as per the instructions.

Do not exceed the permissible total weight or axle load (see rating plate or vehicle documents). When using ballast weights, make sure of correct tyre pressures!

23.1 Front ballast

Attachment plate 117 kg:

3 pcs. maximum.

Can only be fitted to tractors without front power lifts.



Fig.254

NOTE:

With the 117 kg attachment plate, fit lock (A).

Hanging weights approx. 42 kg:

Max. of 10.

Can only be fitted to tractors without front power lifts.

An attachment plate is required so that they can be hung.

23.2 Front/rear load weights

Ballasting weight 1,800 kg

Front/rear weight 870 kg

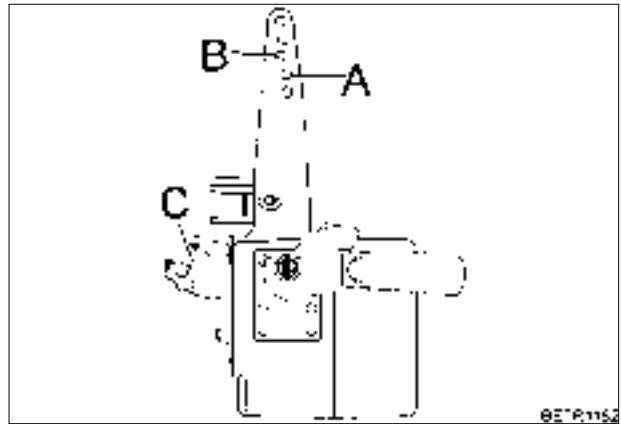

Fig.255

- A = Fastening point of top link.
- B = Fastening point for top link with quick-release coupling.
- C = Attachments for packer transport (single-row packer max. 1,000 kg). Additional weights are not possible.

NOTE:

870 kg weight can also be supplemented by 3 x 117 kg attachment plates or 8 x 42 kg wafer plates. Observe permissible front axle loads.

23.3 Wheel weights



WARNING:
Observe the maximum permissible width indicated in the vehicle documents.

Max. 4 x 295 kg may be mounted.

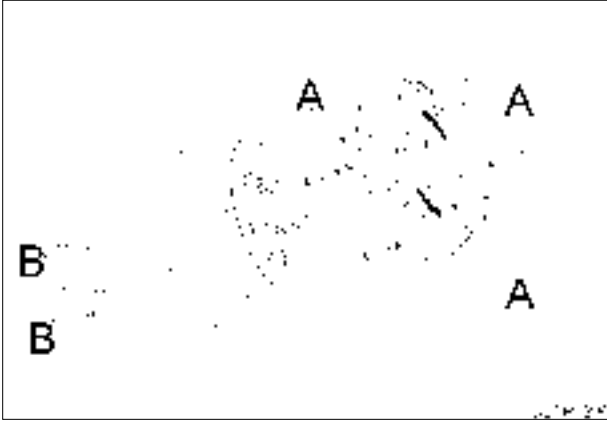

Fig.256

- A = Starting torque 210 Nm.
- B = When replacing screws, new screw length 95 mm.
Starting torque 600 Nm.

NOTE:

No wheel load weights must project over the tyres, otherwise they cannot be used on the public highway.

23.4 Water ballasting of tyres

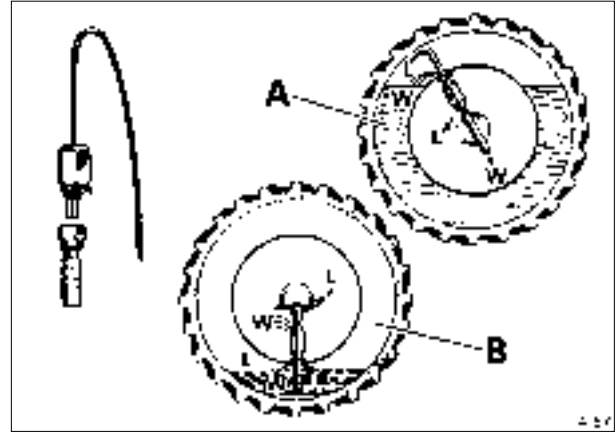

Fig.257

- A = Fill with water.
- B = Drain water.
- L = Air.
- W = Water.

Follow tyre manufacturer's specifications with regard to volumes (water + antifreeze solution). Check tyre pressures regularly.

24. Track adjustment



DANGER:

When working on tyres, make sure the tractor is properly parked and secured against rolling away (wheel chocks)!

If the engine needs to be started for turning the wheels, both wheels must be jacked up and turn free.

When the tractor is jacked up and some one is working underneath, no one else should be on the tractor.

If the tractor is lifted with the lower links, additional supports are required!

Tyre repairs should be performed only by qualified personnel using suitable tools.

Tyres may explode if the air pressure is too high! Check tyre pressures regularly!

Do not use special protective tyres for heavy-duty traction work or front loader operations; maximum road speed 25 km/h.

After wheel mounting or track adjustment, tighten the bolts and nuts on front and rear wheels and on track adjusting elements. Check these regularly!

24.1 Lighting wide vehicle

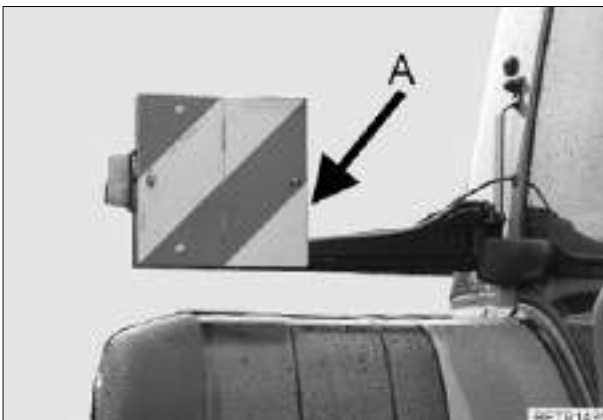

Fig.258

Apply left and right warning signs flush with the outer edge of the tyre.

Tighten locking screw (A) at 5 Nm.

24.2 Rear axle stub

(optional).

Change track width

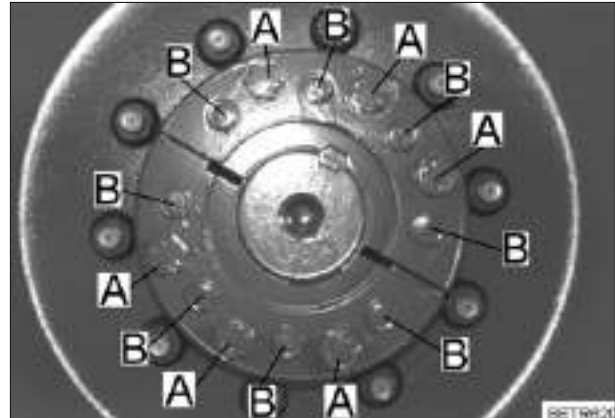

Fig.259

Jack up rear wheels, loosen screws (A).

Screw in the screws (in tool box) in hole (B) to loosen the chuck cone.

Set to the desired track width.

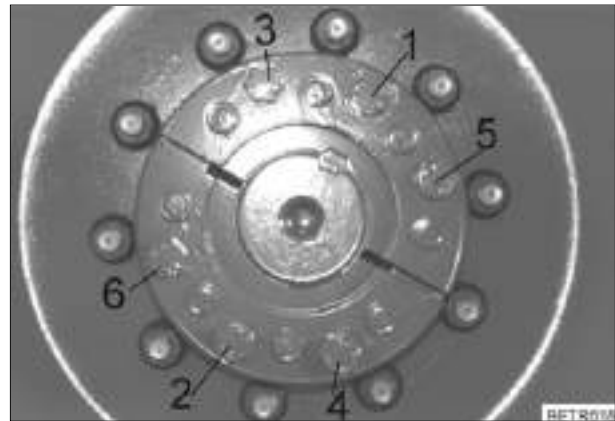

Fig.260

If the track width is changed, the mounting bolts should be tightened in accordance with the following diagram.

- 1 = Tighten hexagon screws in the order shown (1-6) at a torque of 200 Nm.
- 2 = Tighten hexagon bolts to Nm in the order shown (1-6).
- 3 = Drive tractor for a couple of hundred yards then retighten to 600 Nm in the order shown (1-6).
- 4 = After another 3 operating hours, retighten in the order shown (1-6), to 600 Nm.
- 5 = After 10 additional operating hours retighten according to the shown pattern (1-6) at 600 Nm.

Replacing rims with rear axle stub

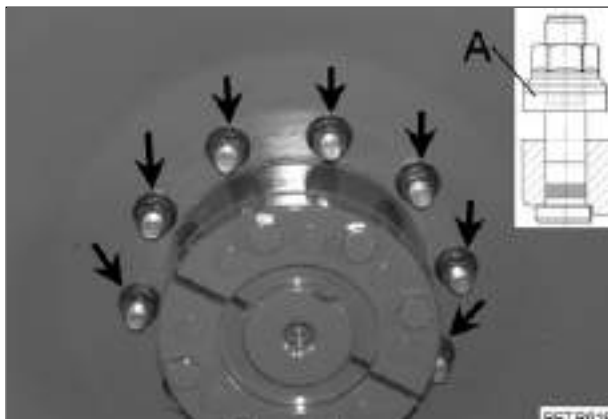

Fig.261

NOTE:

If changing the rims, check that washers (A) are present.

25. Twin tyres



WARNING:

When working on tyres, make sure the tractor is properly parked and secured against rolling away (wheel chocks)! When the tractor is jacked up and some one is working underneath, no one else should be on the tractor. See also safety directions in Track width adjustment. For tightening torque, see TECHNICAL DATA.

Twin tyres may be used to reduce ground pressure but not to increase load capacity or pulling power.

NOTE:

For use on public roads, twin tyres must be indicated in the vehicle registration documents. The twin tyre selection table in this manual may be used when presenting the tractor at a vehicle testing station.

25.1 Conditions for use

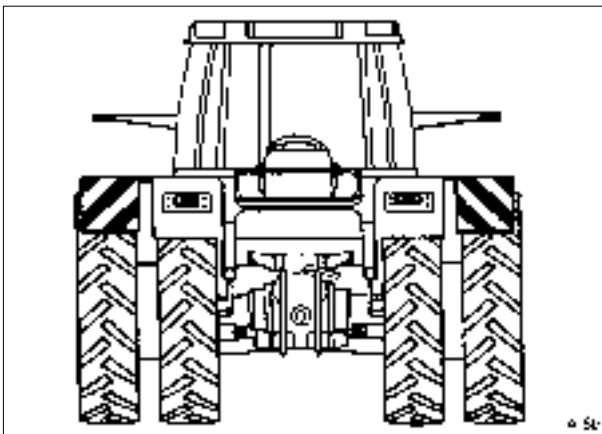

Fig.262

- If the standard lights are more than 400 mm from the vehicle outer edge, tail lights, side lights and reflectors must be duplicated. If necessary, fit marker lights.
- In excess of 2,750 mm width, fit warning plates front and rear.
- Max. ground speed 25 km/h (as per vehicle licensing regulations if wheels have insufficient covering).

25.2 Twin tyres

2 x standard tyres

Inner tyre track 2000	Outer tyres *	Inner tyre track 1970	Outer tyres *
480/70-R34	480/70-R34	580/70-R34	20.8-R42
480/70-R34	16.9-R34	580/70-R34	580/70-R34
520/70-R34	520/70-R34	620/70-R42	20.8-R42
520/70-R34	18.4-R34	620/70-R42	620/70-R42
600/65-R34	600/65-R34	650/65-R34	20.8-R42
600/65-R34	18.4-R34	650/65-R34	650/65-R34
600/65-R34	600/65-R34	680/85-R38**	680/85-R38**
600/65-R34	600/65-R34	710/70-R42**	710/70-R42**

* Permissible axle load on request, only HD system from Grasdorf approved.

** for 924 - 930 only.

Twin wheels cannot be used as single tyres. Consult mounting instructions of the manufacturer of twin tyres.

Ordering and delivery information by:

Fa. Metallbau Grasdorf GmbH, Ziegelei Straße 29, 31188 Holle

Telephone +49 (0) 5062/902-0, Fax +49 (0) 5062/902-139

26. On-board computer

Functions of the on-board information system:

- E = Setting time.
- F = Calibrating speed display.
- G = Fault display.

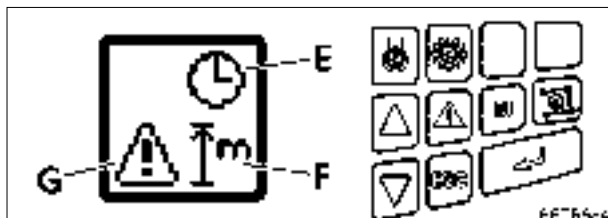

Fig.263

On-board computer keypad:

- On-board computer - opening or exiting a function.

The multiple display switches from standard display (clock, operating hours) to computer functions.

NOTE:

Before using the on-board computer, any existing fault messages must be cancelled (see also FAULTS AND REMEDIAL ACTIONS Section 1.3).

- Up or down to select the desired function.
-
- Confirm, set or disable the selected function.
- Return to previous function.
- Terminating all on-board information system function on each function level.

Other keypads

- 'Quit' key (see also FAULTS AND REMEDIAL ACTIONS Section 1).
- Entering tyre size (see also OPERATION Section 26.4) and calling the service function (settings carried out at workshop).
- No function.
- Open the EPC Service function (setting function for the workshop).

26.1 Setting the clock

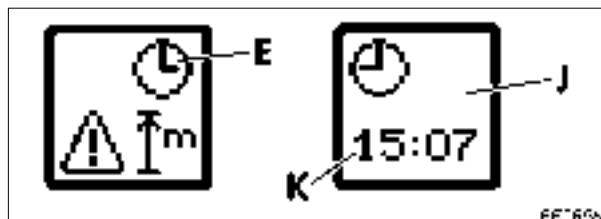

Fig.264

- Press key - function selection is displayed.
- Press one of the keys repeatedly until the set clock symbol (E) flashes.
-
- Press key - screen (J) appears, 1st digit (K) flashes.
- Press repeatedly one of the keys until the desired digit shows.
-
- Press button. Set consecutively remaining 3 digits the same way as the 1st digit.
- Press (ESC) key twice (new time is shown on the multiple display).

26.2 Adjusting speed indicator

Calibration allows the speed display to be accurately adjusted to field conditions, e.g. when operating with mounted implements or in the event of tyre wear.

NOTE:

Use only the clutch pedal to drive the tractor during the calibration process. If driving with the joystick, the ACTIVE symbol, which appears when stopping at marker points, cancels the menu-assisted adjustment process.

- Measure and mark an exact distance between 30 meters (minimum) and 100 meters (maximum).

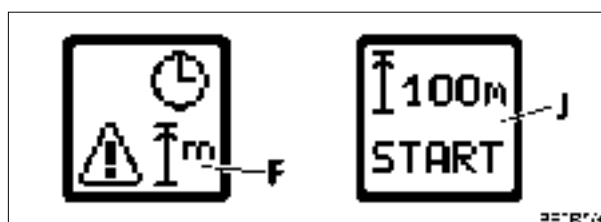



Fig.265

- Press key - function selection is displayed.

OPERATION

 Press one of the keys repeatedly until the 'Adjust speed indicator' symbol (F) flashes.



 Press key - screen (J) appears. 1st digit of the distance flashes.

The measured distance must now be entered, e.g. 50 m.

 Press one of the keys repeatedly until the desired digit is displayed, e.g. 0.



 Press button. Set the other 2 digits one after another as with 1st digit, e.g. 050.

After confirming the last digit, START will flash.

- Move the tractor to position the front wheel exactly at the start mark.

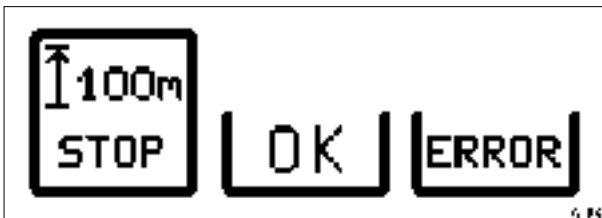







Fig.266

 Press key, the display changes from 'START' to 'STOP'.

- Start the tractor off, and stop with the front wheels at the end mark of the measured distance.
-  Press button. If the process was completed correctly, an 'OK' message appears.
-  Press key - clock and operating hours are displayed.

If an 'ERROR' message is displayed, repeat the adjustment process as follows:

 Press key, data entered for the measured distance is displayed.

- Check whether the measured distance and the input distance are the same.
- If necessary, enter measured distance as described previously and repeat calibration procedure.
-  Press key - clock and operating hours are displayed.

26.3 Fault display

When a fault occurs, an error code is stored. These codes can be called up by the workshop for prompt error diagnosis.

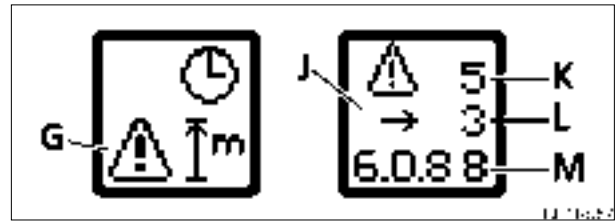







Fig.267

Displaying stored fault codes

-  Press key - function selection is displayed.
-  Press key repeatedly until 'Fault Display' symbol (G) flashes.
-  Press key repeatedly until 'Fault Display' symbol (J) flashes.
-  Press key - screen (J) is displayed.

The following are displayed:

- K = Number of stored fault codes (maximum 50).
- L = Number of the displayed fault code.
- M = Fault code.

-  Press one of the keys repeatedly to show the stored fault codes one after the other (also see FAULTS AND REMEDIAL ACTIONS Section 5).
-  Press key - clock and operating hours are displayed.

26.4 Selecting tyre size

If the tyre size is changed, the speed indicator can be quickly adapted to the new tyre size.

Input value:

The rolling circumference of the rear tyres must be entered in mm.

NOTE:

Rolling circumference can vary according to tyre size. Comply with tyre manufacturer's recommendations.

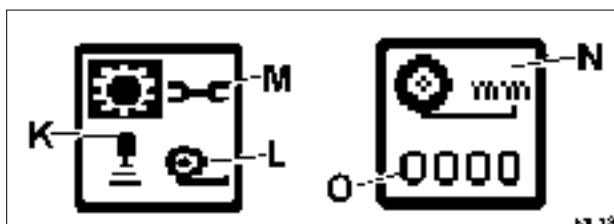

Fig.268

Press key - image (K) is displayed, symbol (L) flashes.

L = Enter tyre size.

M = PTO clutch (rear/front) adjustment function.

Press key - screen (N) is displayed, 1st digit (O) flashes.

Press repeatedly one of the keys until the desired digit shows.



Press button. Set consecutively remaining 3 digits the same way as the 1st digit.

Press button.

● Switch ignition OFF and ON (reset).

New value is stored.

26.5 Backup indicators

If one of the direction of travel indicator lamps fails.

forward

reverse

a fault will be shown in the multiple display. A backup indicator can be activated until the faulty indicator lamp is replaced.

Activating the backup indicator

After removing all warning or fault codes, the backup display will be automatically activated.

How to clear the fault messages (see FAULTS AND REMEDIAL ACTIONS Section 1.3).

By pressing the key, the time and operating hours display is shown for a period of 5 sec.

If within 5 seconds, the key is pressed a second time, the functions of the on-board computer will be displayed.

Backup display symbols



Forward selected.



Forward engaged.



Reverse selected.



Reverse engaged.



Forward engaged, reverse selected.



Reverse engaged, forward selected.

OPERATION

27. Computer

27.1 Computer functions

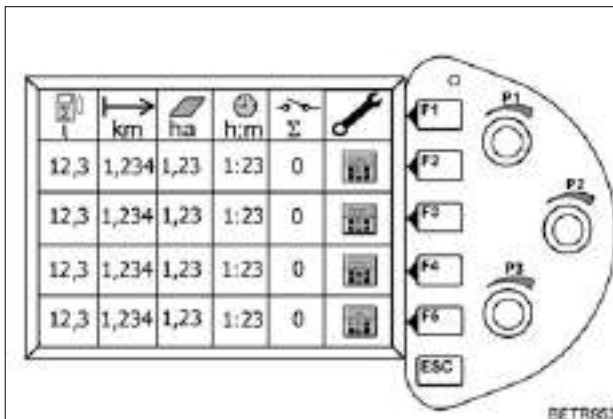

Fig.269

- Fuel consumption
SCH116
- Distance measurement
SCH38
- Area measurement
SCH27
- Stop watch
SCH36
- External counter
SCH28

The signal from the on-board computer is passed through an external counting sensor (e.g. on baler, sprayer).

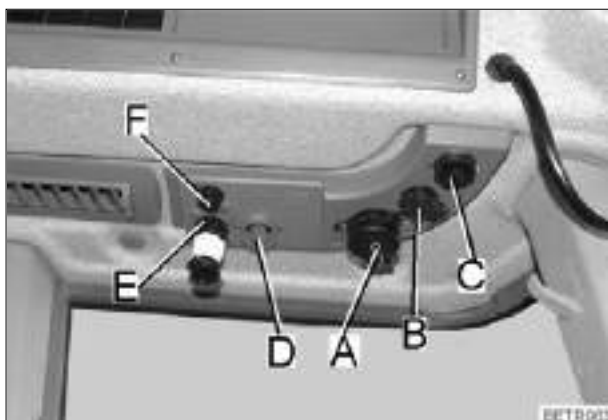

Fig.270

- Connect external counter plug in blue socket (D).

The individual measuring/counting process can be made subject to a certain condition, as follows:

- Measurement or counting only conducted if:
1. PTO (rear/front) is activated.
 2. lifting gear (rear/front) is lowered.
 3. external counter switch closed.

27.2 Select main menu

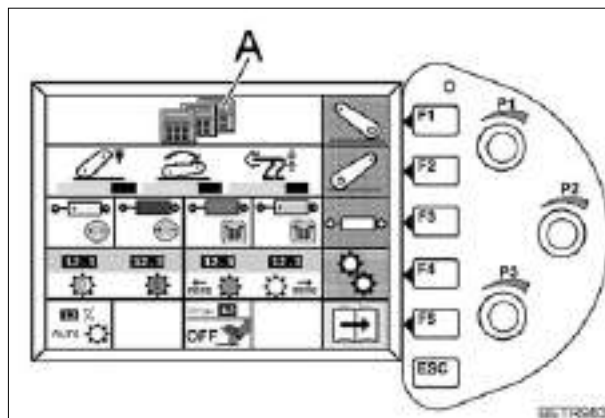

Fig.271

Symbol (A) shows whether one or several computers are activated in background.

- Press key (F5). The following sub-menu appears.

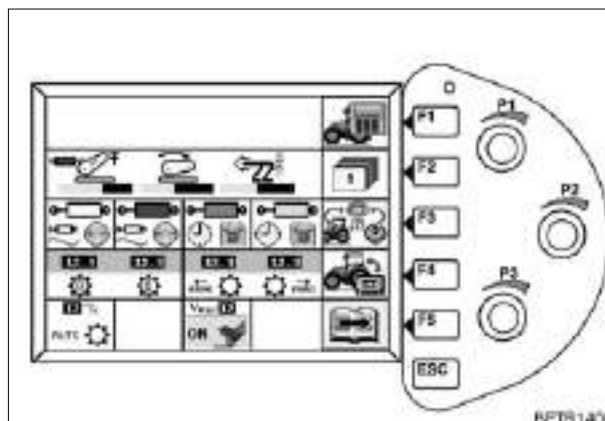

Fig.272

- Press key (F1). The following sub-menu appears.

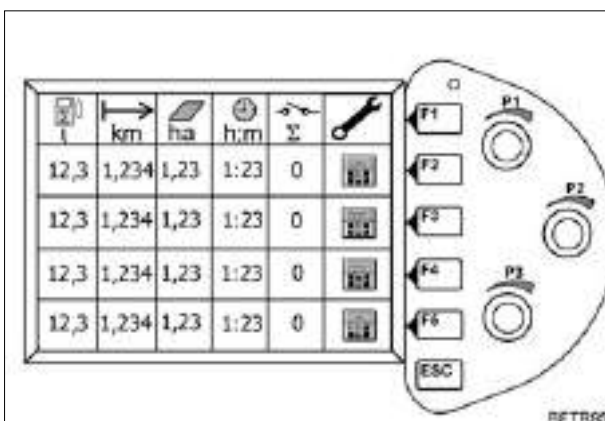

Fig.273

The main menu shows the measured and counted data.

NOTE:
Press ESC to return to previous menu level.

27.3 Setting measurement and counting direction

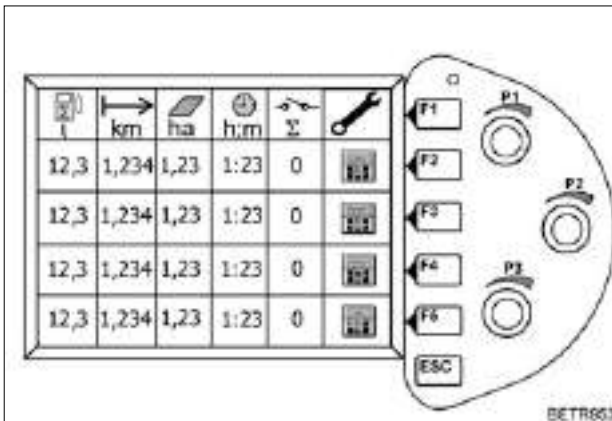

Fig.274

- Press key (F1). The following submenu appears.

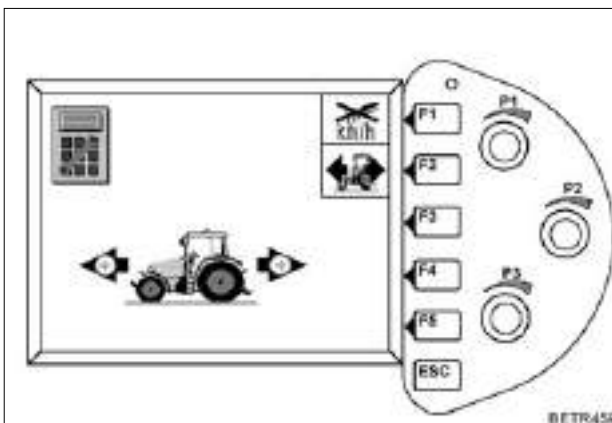
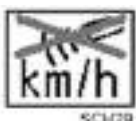

Fig.275

Press key (F1), select between:



Real speed
(Radar sensor).



Theoretical speed (the measurement result is distorted if there is wheel slip).

Press key (F2), select between:



Measurement only available with forward travel
(Standard setting).



Measurement only when travelling in reverse.



Measurement only in forward travel
(in reverse, the calculation is subtracted).



Measurement only in reverse (in forward travel, the calculation is subtracted).



Measurement in forward and reverse.

NOTE:

Press ESC to return to previous menu level.

27.4 Manually triggered measuring and counting

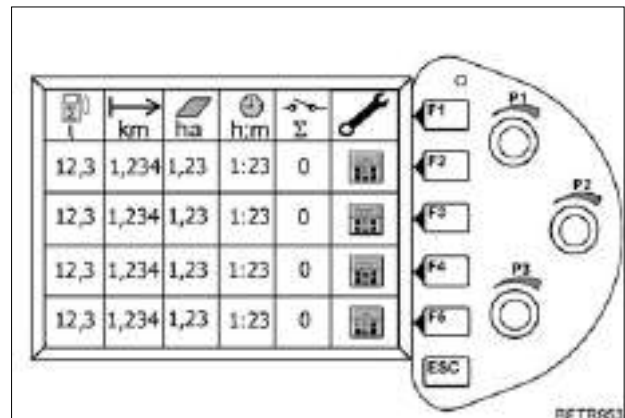

Fig.276

- Press key (F2 or F3 or F4 or F5) (location 1 - 4). The following submenu appears.

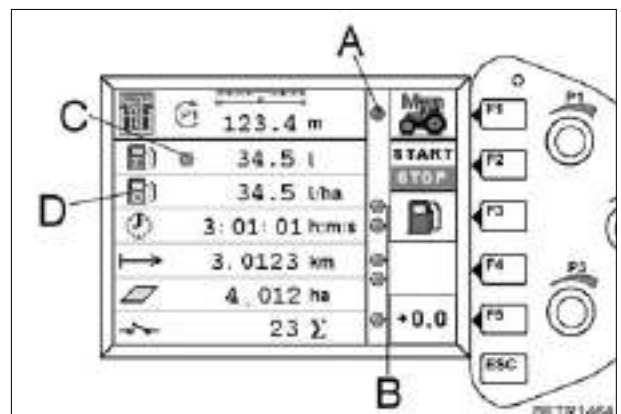

Fig.277



Set trailed implement width with rotary control (P1).

OPERATION

Activating / Deactivating measurement and counting function.



Press key (F3) to activate or deactivate the fuel consumption display.
LED (C) is lit green when measurement is active.
Display for average fuel consumption (D), litres per hectare.

NOTE:

Before an average fuel consumption measurement is carried out, reset measurement reading to "0" to get a meaningful average.



Press key (F2) to switch on/off. If the measuring and counting function is active, LED (A) lights up. The LEDs (B) are lit (for information only) if the front/rear power lift of the front/rear PTO and the event counter is operated.

Resetting on-board computer functions and fuel consumption indicator to "0".



Press key (F5) - all values are reset to '0'. Only possible if no measurement is running - except the fuel consumption indicator.

NOTE:

Press ESC to return to previous menu level.

27.5 Operating automatic measurement and counting

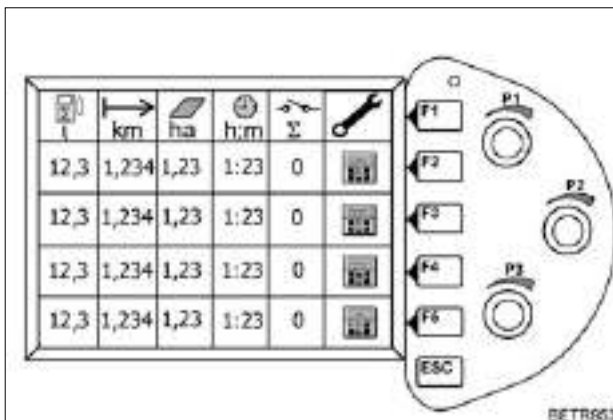

Fig.278

- Press key (F2 or F3 or F4 or F5) (location 1 - 4). The following submenu appears.

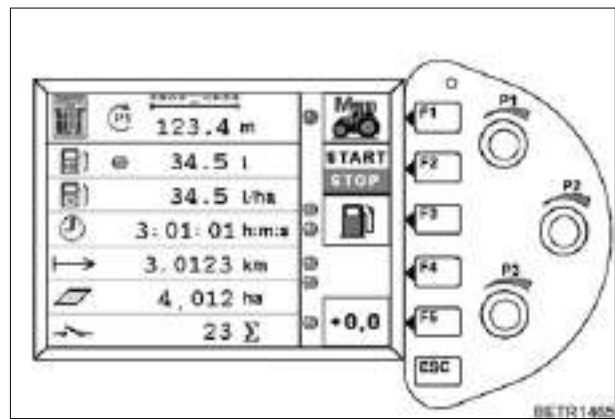

Fig.279

- Press key (F1). The following sub-menu appears.

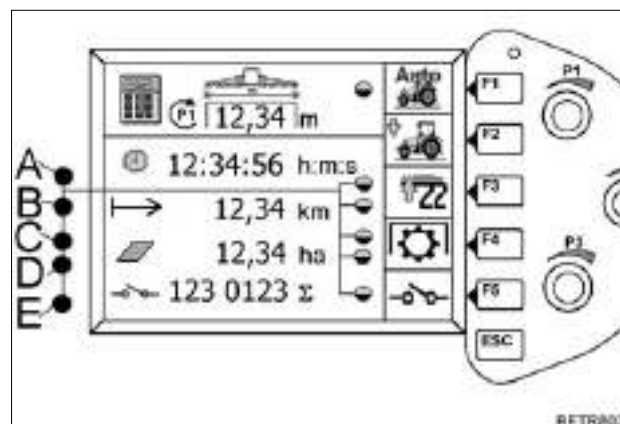

Fig.280

Function indicators

- A = Front power lift
- B = Rear power lift
- C = Front PTO
- D = Rear PTO
- E = Event counter



Set trailed implement width with rotary control (P1).

Select forward or reverse measurement.

To toggle, press key (F2).

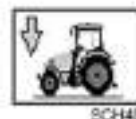

Activate lifting gear measurement (can also be combined with PTO measurement and/or external counter).



To activate, press key (F3). When activated, the symbol has a green background.

Measuring and counting only if lifting gear is switched to 'Control' (lowering).

Activate PTO measurement (can also be combined with lifting gear measurement and/or external counter).



To activate, press key (F4) - the green symbol indicates active status.

Measuring and counting only available with rear or front PTO engaged.

Activating external counter input.

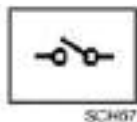

Connect cable (ID. No. 0071 023 100) to blue socket (see picture OPERATION Fig. 270).

To activate, press key (F5). When activated, the symbol is lit green. Measuring and counting only possible if there is a sealed counting sensor on the implement (e.g. hydraulic fertiliser spreader) and this is connected to the on-board computer.

NOTE:

Press ESC to return to previous menu level.

28. Storing the settings

This setting saving function allows four different sets of parameters to be saved and named under any name and recalled when needed.

28.1 Setting that can be saved

Comfort front power lift

- Lock status
- Cross adjustment - floating setting
- Lift flow regulation
- Lower flow regulation
- Maximum lifting height

Rear power lift (EPC)

- Lock status
- Slip control status
- Lowering speed
- Mix ratio (position/traction control)
- Wheel slip setting
- Switch-on speed for vibration damping
- Maximum lifting height
- Automatic function

Rear PTO

- Rear PTO rpm
- Automatic function

Electrical valves 1-4

- Valve priority
- Lock status
- Kick-out status

- Timer setting
- Lift flow regulation
- Lower flow regulation
- Timer function selection

External valve actuation

- Valve selection (3rd valve or 4th valve)

Load limit control

- Engine speed drop set value

Cruise control

- Tempomat cruise control speed 1
- Tempomat cruise control speed pre-selection 1
- Speed cruise control 2
- Tempomat cruise control speed pre-selection 2

Quick reverse

- Reversing speed

Electronic accelerator

- Min/Max engine speed values

4WD

- 4-WD pre-selection

Differential lock

- Pre-select differential lock

Suspension

- Suspension mode pre-selection

Tractor Management System (TMS)

- TMS operation ON
- Accelerator mode ON
- Set engine speed range
- Operating status (PTO, power lift, hydraulic valve function) of the engine speed control

Variotronic Ti

- Stored operating sequences available for play back

OPERATION

28.2 Saving names and settings

Engine must be running to allow a setting to be saved.

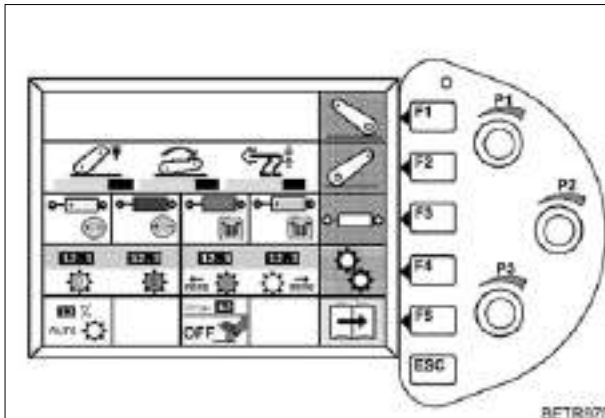

Fig.281

- Press key (F5) - the next screen is displayed.

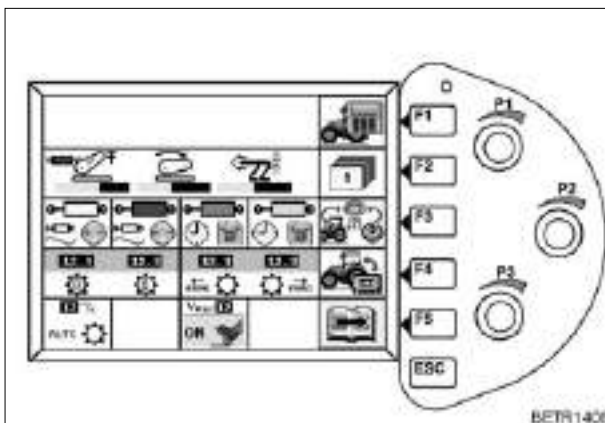
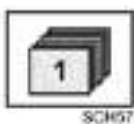

Fig.282



Press key (F2). The following sub-menu appears.

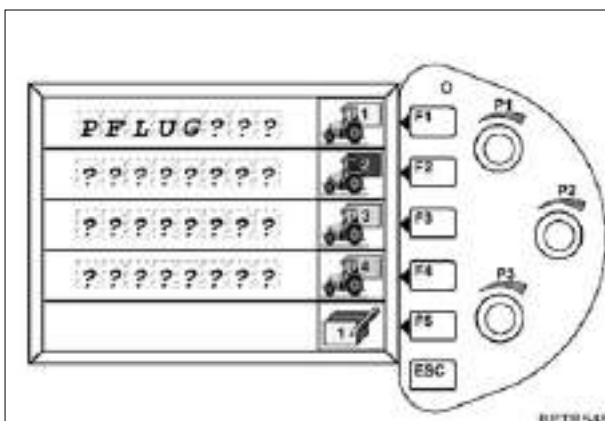

Fig.283

If the name consists of question marks only, no parameters have been stored in this memory location.



Press key (F5). The following sub-menu appears.

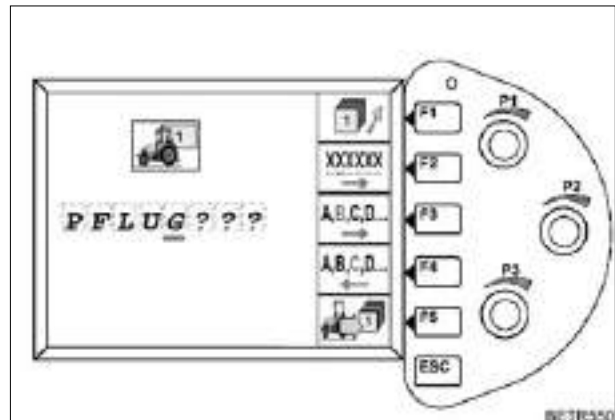
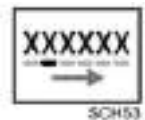

Fig.284



Key (F1) to select memory locations 1 - 4.



Key (F2) to select the location of input characters (letters or numbers).



Press key (F3) to scroll characters (letters or numbers) forward (one character at a time).



Key (F4) scrolls the characters (characters or numbers) backward (one character at a time).



Quick scroll (selection) forward or backward through characters (letters or numbers), several characters at a time.



Use key (F5) to save settings.

Settings are stored at the selected memory location under the selected name.

The following submenu appears.

28.3 Calling up settings

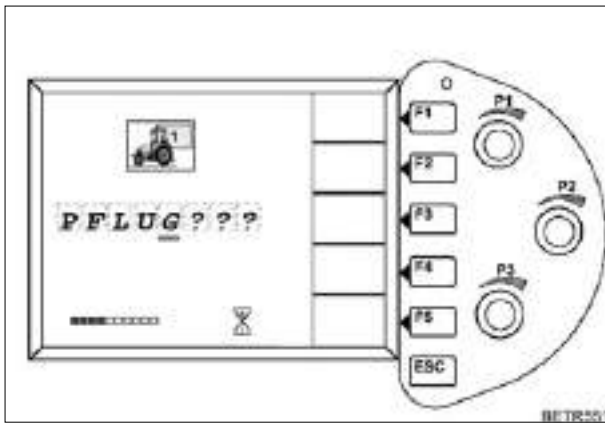

Fig.285

The following submenu appears.

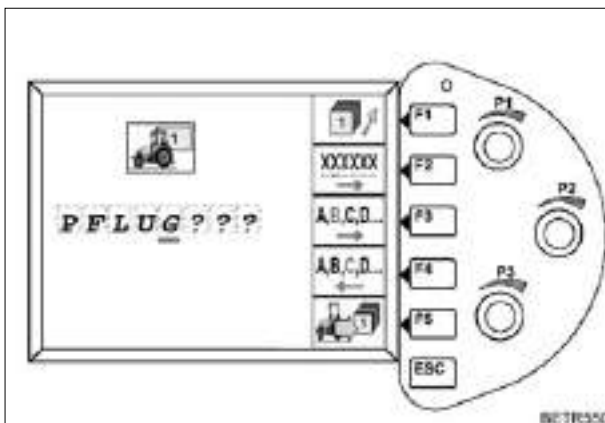

Fig.286

NOTE:
Use the **ESC** key to return to the previous function levels.

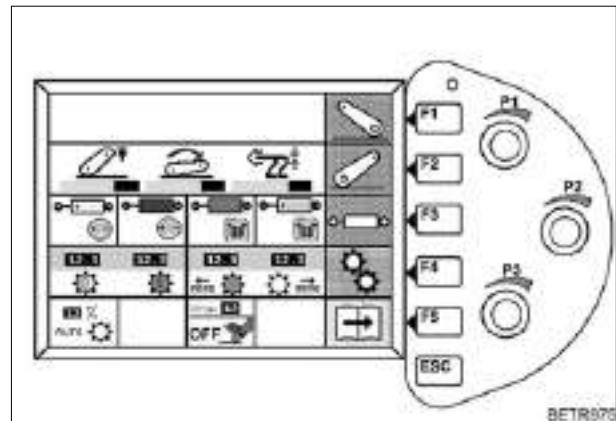

Fig.287

● Press key (F5) - the next screen is displayed.

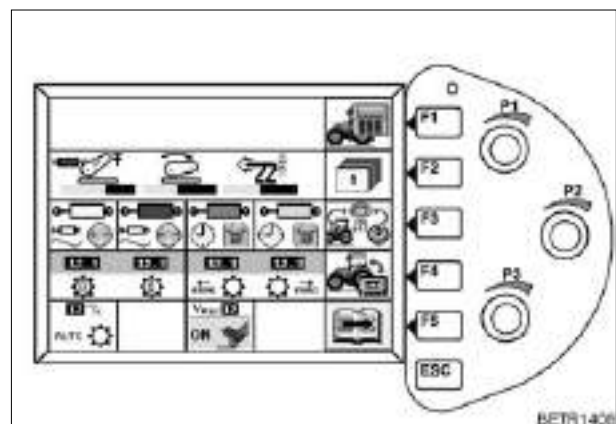
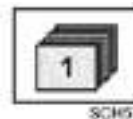

Fig.288



Press key (F2) - the following submenu is displayed.

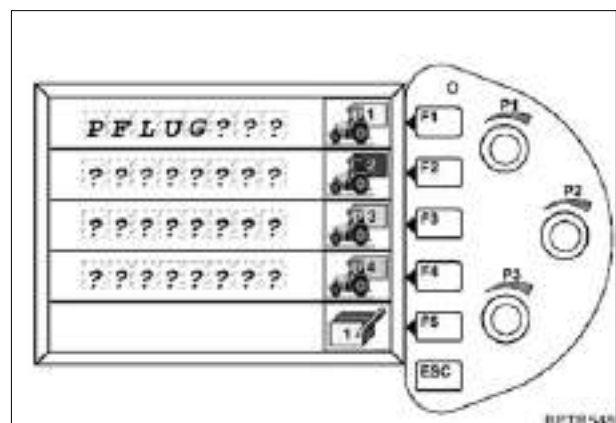

Fig.289

With keys (F1 - F4) select the set of parameters to be loaded.

Following screen appears.

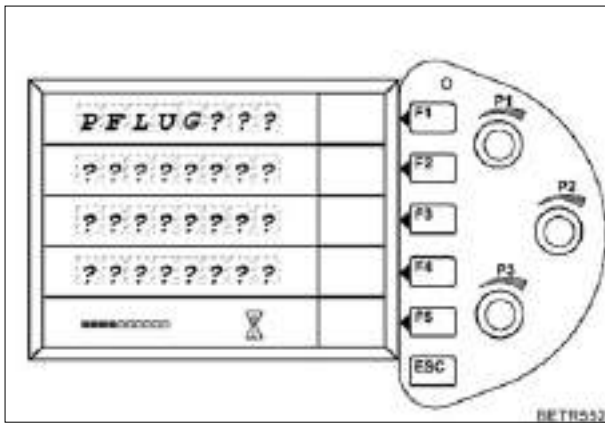

Fig.290

The following sub-menu then automatically appears. Settings are stored.

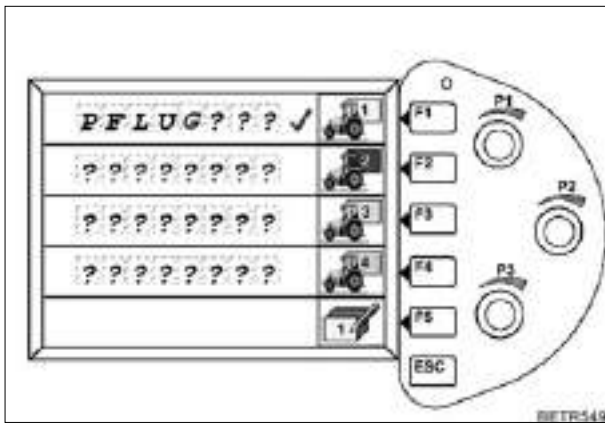

Fig.291

If the parameters are loaded successfully, a checkmark appears next to the memory location.

The following sub-menu then automatically appears.

NOTE:

Engine must be running with the transmission in neutral position.

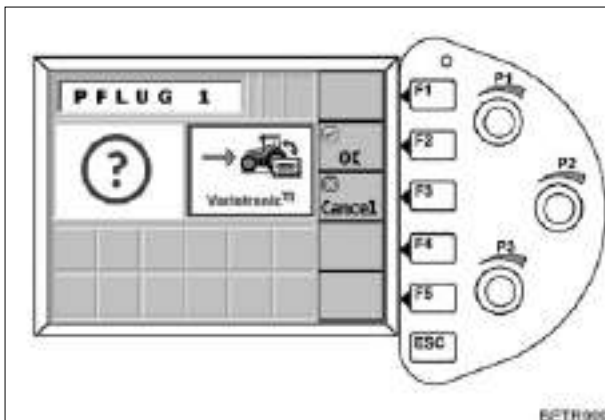

Fig.292

- Press key (F2). The Variotronic Ti menu appears. For further description (see OPERATION Section 30).
- Press key (F3) to return to first main menu.

29. Implement control

With the implement control, the existing controls on the tractor (operating terminal, joystick) can be used for operating the attached implement.

ESC key

The ESC key has a double function in implement control.

 Press key once (for about 1 sec.) to return to previous function level.

 Press key twice to toggle between last selected tractor menu and last selected implement control menu.

This function only works if there is an active mounted implement.

29.1 Assigning control terminal

An LBS control terminal can also work via a separate control terminal, e.g. Fieldstar, therefore the system must be informed which control terminal is to be used.

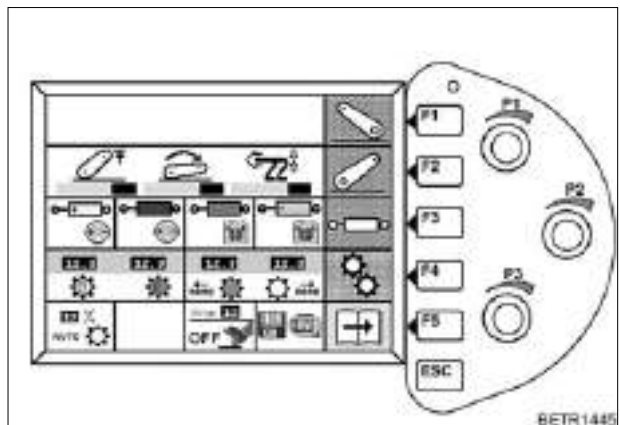

Fig.293

- Press key (F5). The following sub-menu appears.

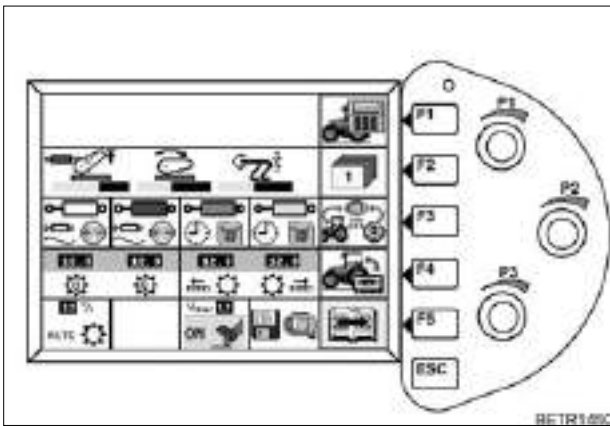

Fig.294

- Press key (F5). The following sub-menu appears.

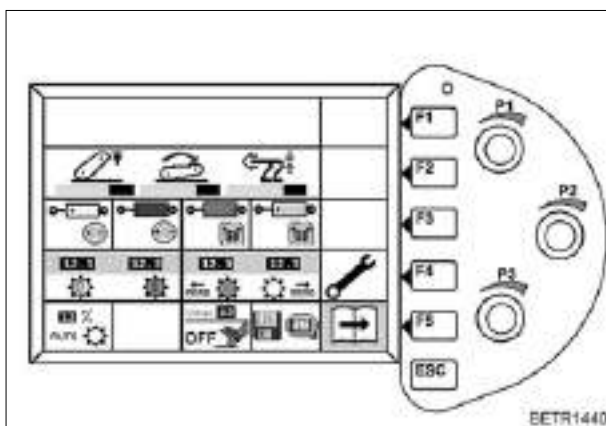

Fig.295

- Press key (F4). The following sub-menu appears.

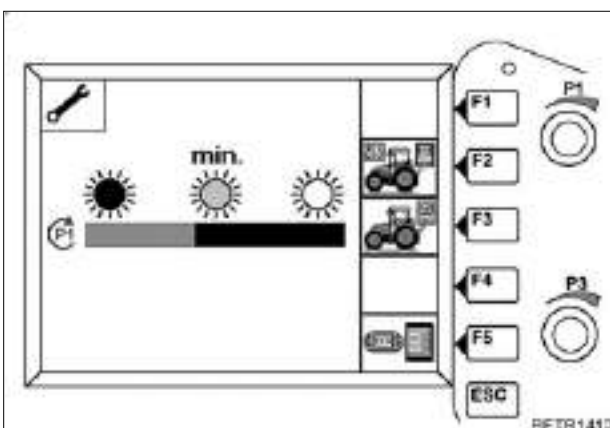

Fig.296

Press key (F5) - select between:



LBS control terminal and FIELDSTAR control terminal.



LBS control terminal.



Deactivating implement control.



ISO control terminal.



LBS control terminal or ISO control terminal.

NOTE:

Settings are active after exiting the submenu.

OPERATION

29.2 Loading the implement software for implement control

Ignition OFF. Connect the mounted implement to the tractor using the LBS socket.

Ignition ON.

The following menu quickly appears in the control terminal.

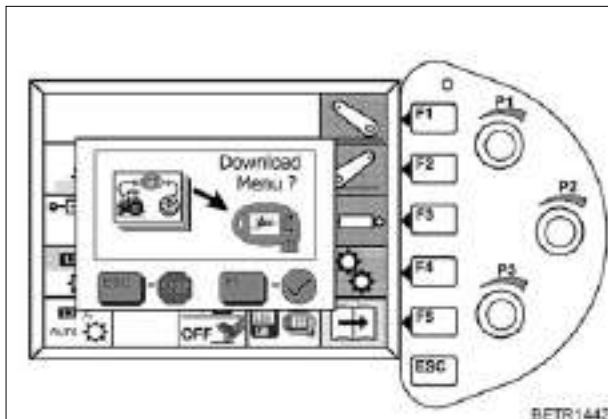

Fig.297

After approx. 30 seconds, download will be initiated automatically.

The **F1** key can be used to start the loading process immediately.

The **ESC** key can be used to abort the loading process.

Once the downloading process has started, the following menu appears in the control terminal.

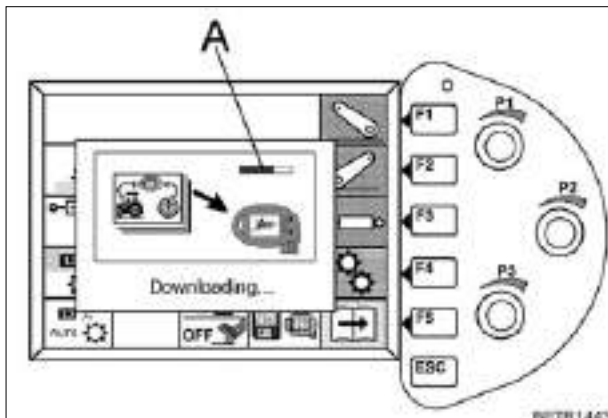

Fig.298

Indicator bar (A) **Red**: progress of memory erasing.

Bar indicator (A) **Green**: progress of data transfer from the implement to the operating terminal.

If downloading has been successful, the following image appears.

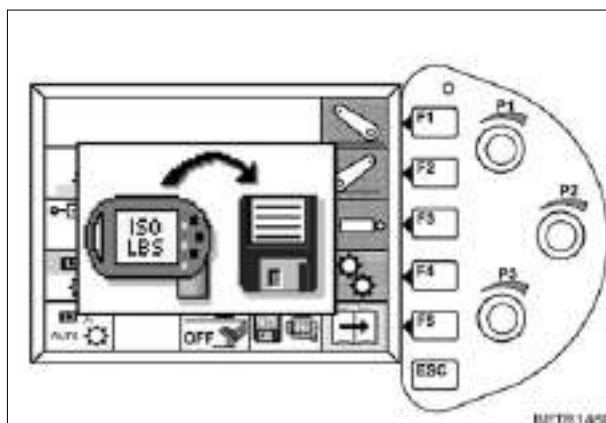

Fig.299

If downloading has been successful, the following image appears (A).

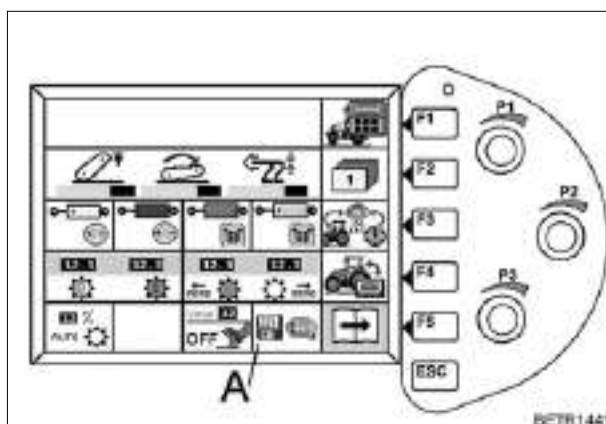

Fig.300

NOTE:

Up to four working implements can be stored. If the data memory is full, the data for the implement not used for the longest time are deleted.

If the loading process is not successful, the following menu appears on the control terminal.

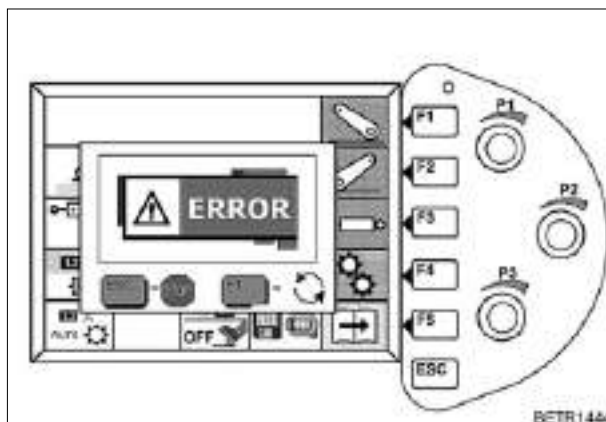

Fig.301

Press key **F1** to re-start the loading process.

Press key **ESC** to abort the loading process.

NOTE:

Check connections and the fuses in case of repeatedly unsuccessful download attempts. Disconnect and reconnect the implement from and to the LBS/ISO socket. Restart tractor.

29.3 Setting up the control terminal for implement control

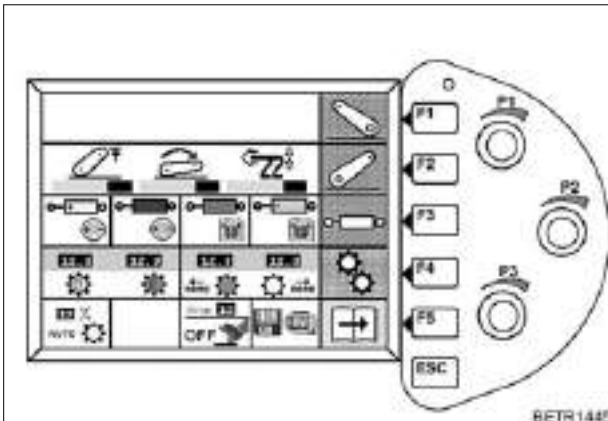

Fig.302

- Press key F5. The following sub-menu appears.

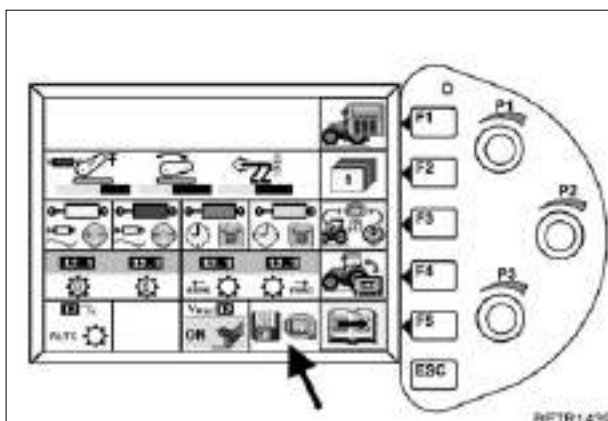

Fig.303

The control terminal shows:

LBS-ISO implement active.



NOTE:

Appears shortly, as soon as the control terminal has successfully logged onto the LBS-ISO bus.



One or more implements are already stored in implement control.



Vario terminal deactivated as an LBS-ISO control terminal, no implement control possible.

Press F3 key.

The start menu for the connected implement (e.g. forage box).

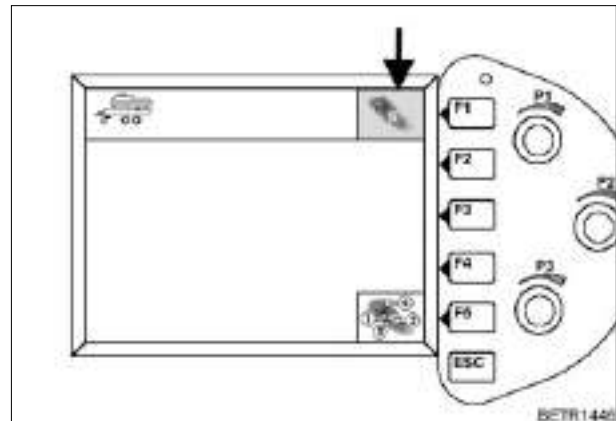

Fig.304

- Select/activate the joystick and connected implement with the F1 - F4 keys.

Function displays

None = no implement is stored.

Blurry = implement is stored but not active.

White = implement active without joystick.

Green = implement active with joystick.

Strikethrough = implement can not be assigned.

OPERATION

29.4 Operating the implement with the joystick

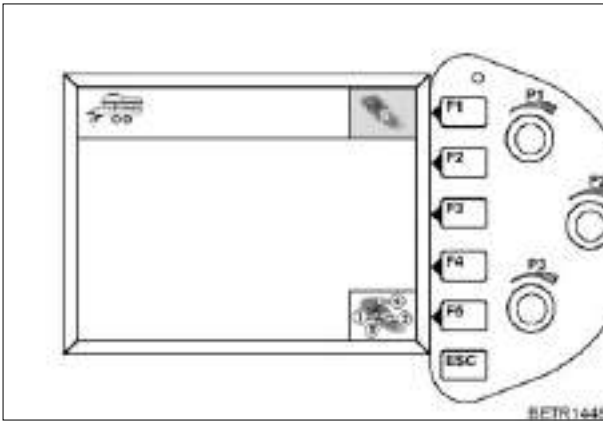

Fig.305

- Assign joystick with the F1- F4 keys.
- To change the control button assignment, press the F5 key.

NOTE:

The following sub-menu appears only for ISO implements for which the control button assignment can be changed.

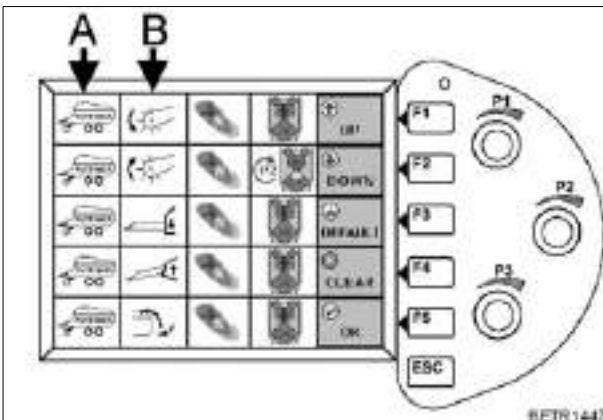

Fig.306

- A = Connected implement, e.g. hay wagon.
- B = Function of the connected implement, e.g. lower pickup, lift pickup, lower draw-bar.....



The button which is to trigger a function is selected with the rotary control (P2).



Browsing forward in the selection menu is also possible with the rotary control (P3).



Browsing backward in the selection menu is also possible with the rotary control (P3).



Automatic assignment of implement functions to a joystick control button (see OPERATION Fig. 307).



No joystick control button assignment, set new assignment.



Go back to previous selection page, **with** saving the control functions.

NOTE:

Go back to the previous function level with the ESC key, without saving.

Automatic assignment

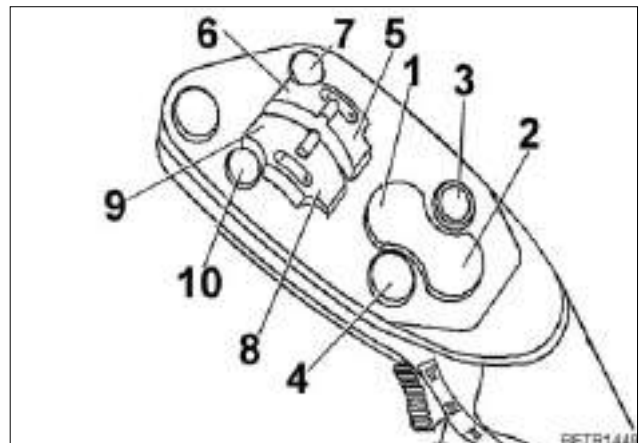

Fig.307

1 - 10 = First, second..... function on the implement.

NOTE:

For the operation of implements with the control terminal, consult the implement manufacturer's operating manual.

29.5 Implement diagnosis function

If the implement manufacturer has met the required conditions, any faults in the attached implement can be displayed on the operating terminal.

Example:

If the hay loader is decoupled in implement control mode, the following menu appears.

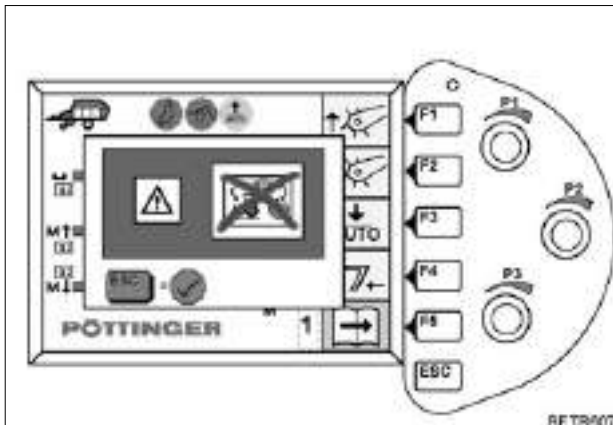

Fig.308



A fault message is also displayed on the multiple display. The warning lamp also flashes and a warning tone is sounded.

The error message can be acknowledged by pressing the ESC key (on the Vario Terminal).

NOTE:

If the error occurs again: Refer to the implement manufacturer's operating manual, or contact the manufacturer's customer service.

30. Variotronic Ti

The TeachIn function enables repetitive operational sequences to be saved and retrieved when needed.

An individual set of functions and relative factors can be selected (e.g. an engagement/disengagement point can be selected for the rear PTO according to distance, time, lift height, or can be selected manually by pressing a button).

NOTE:

On the driver seat is a start-off protection. If the driver's seat is unoccupied for more than 3 seconds, the pull-away cut-out is activated. Variotronic Ti functions cannot be played back. If a function or a trigger is required during recording, which is not already in the configuration list, adapt the configuration list (see OPERATION Section 30.9).

30.1 Functions



Rear power lift
(Raise, Control, Stop, Fast feed-in).



Front power lift
(Raise, Control, Stop, Floating position).



Rear PTO
(ON - OFF).



Front PTO
(ON - OFF).



Electric hydraulic valves
(Raise, Lower, Stop, Floating position).



Vario transmission
Cruise control (ON - OFF).

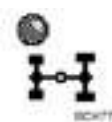

4-WD
Automatic mode, 100%, OFF.

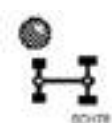

Differential locks
Automatic mode, 100%, OFF.



Electronic engine control
(ON-OFF, calling up stored engine speeds).

30.2 Triggers



Distance
(travelled).



Time
(elapsed).



Manual
(by pressing the button).



Lift height of rear power lift.



Lift height of front power lift.

NOTE:

'RED' light = function active.

'GREY' light = function not active.

30.3 Menu functions

Record menu level 1

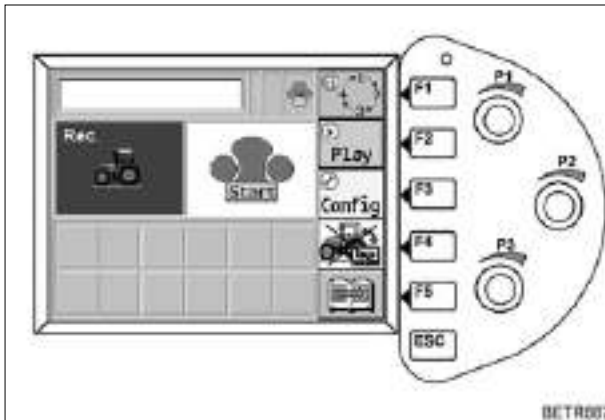

Fig.309



Key (F1) or rotary control P1.
Change the button assignments on the joystick for the controls (Record, Start, Stop, Pause etc.).

SCH093

Different operating sequences can be assigned to all four buttons on the joystick.



Key (F2)
To change to Playback menu.

SCH103



Key (F3)
To modify the configuration lists (see OPERATION Section 30.9).

SCH121



Key (F4)
End Variotronic Ti.

SCH104



Key (F5)
To change to another menu level.

SCH105

Record menu level 2

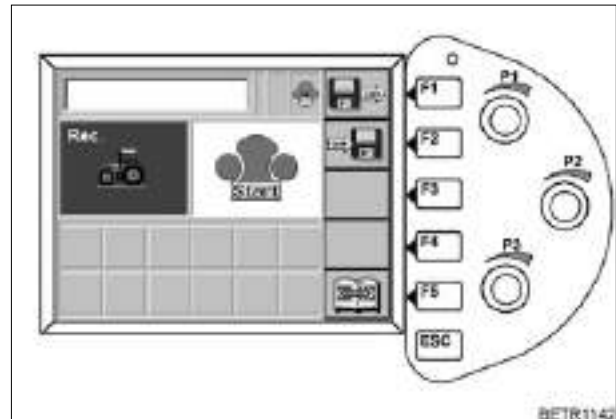

Fig.310



Key (F1) load operational sequence from memory (see OPERATION Section 30.6).

SCH109



Key (F2)
Storing an operating sequence in memory (see OPERATION Section 30.5).

SCH111



Key (F5)
To change to another menu level.

SCH105

OPERATION

Playback menu level 1

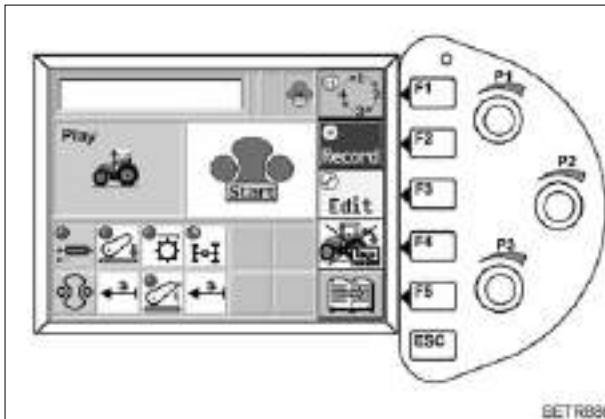

Fig.311



Key (F1) or rotary control P1. to change assignment of joystick key with which operation (record, start, stop, pause, etc.) is controlled.



Key (F2)
To change to Record menu level.



Key (F3)
To change relative factors (see OPERATION Section 30.8).



Key (F4)
End Variotronic Ti.



Key (F5)
To change to another menu level.

Play menu level 2

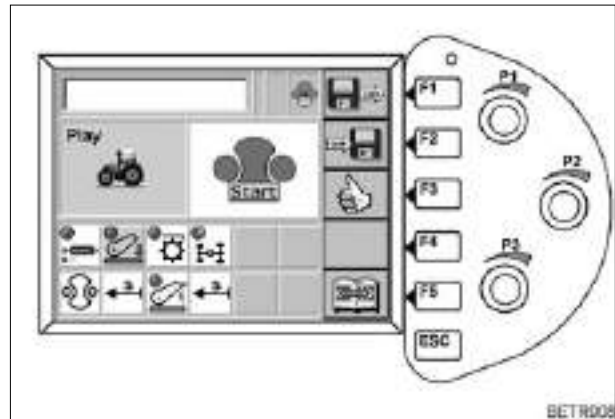

Fig.312



Key (F1) load operational sequence from memory (see OPERATION Section 30.6).



Key (F2) to save operating sequence to memory (see OPERATION Section 30.5).



Key (F3)
Run through operational sequence manually (see OPERATION Section 30.7).



Key (F5)
To change to another menu level.

30.4 Operating

NOTE:

If travelling at more than 25 km/h, playback (Play) is not possible.

Recording of an operational sequence between two activations is limited to 120 seconds and/or 300 metres.

If recording is interrupted for longer than 2 minutes, recording is discarded.

The direction of travel selected for the recording must correspond with the direction of travel selected when playing back. Travelling forward and being stopped are considered the same.

If the playback of a recording is required in the other direction of travel. Record with (Edit), see OPERATION Section 30.8, start, drive in other direction, new direction of travel is saved.

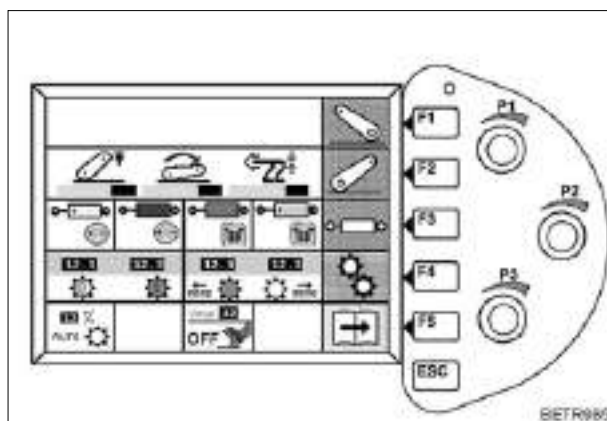

Fig.313

- Press key (F5). The following sub-menu appears.

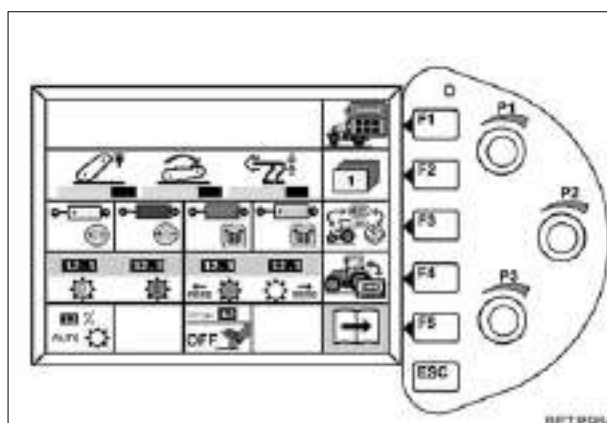

Fig.314

- Press key (F4). The following sub-menu appears.

Record menu level

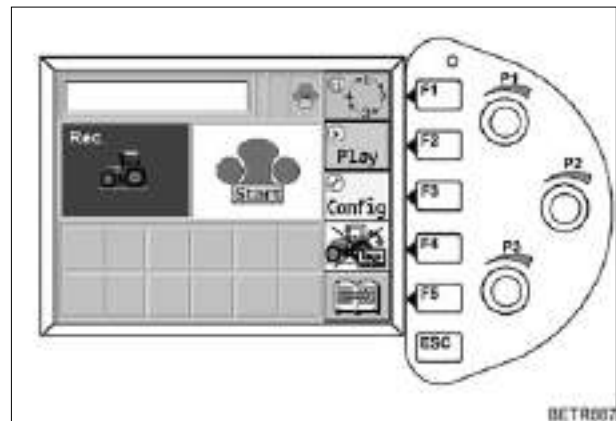

Fig.315

or

Play menu level

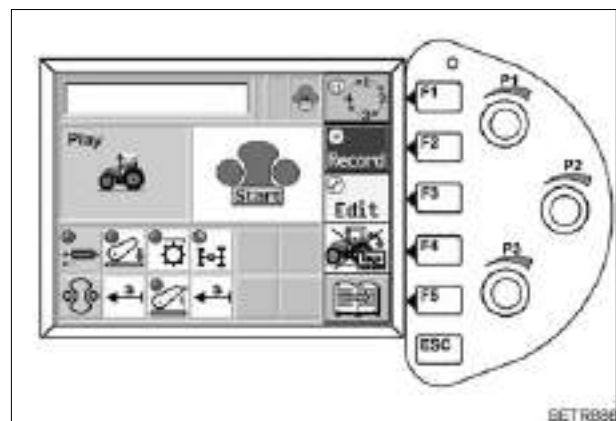

Fig.316



SCH107

Press key (F2)
Change to menu level **Record**.

To record operational sequence.

Up to 13 functions can be put together to form an operational sequence.

In the next example:

- Automatic function power lift and PTO.

The rear power lift is lowered, the rear PTO is engaged at a selected lift height of the rear power lift. The rear power lift is lifted, the PTO is disengaged at a selected lifting height of the rear power lift.

OPERATION

Unlock EPC, select PTO

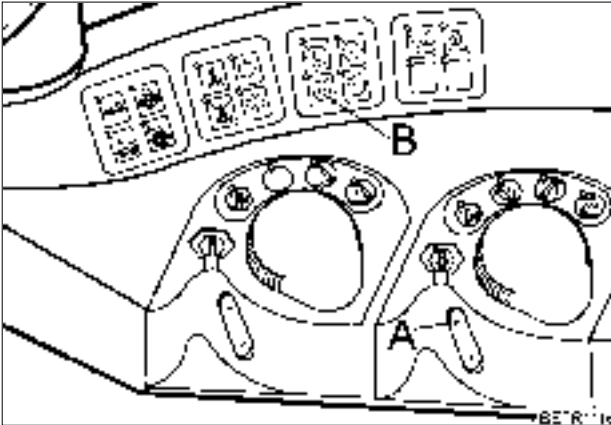

Fig.317

- Start tractor.
- Unlock rear EPC with quick lift key (A).
- Select rear PTO speed using button (B).

Joystick key assignment

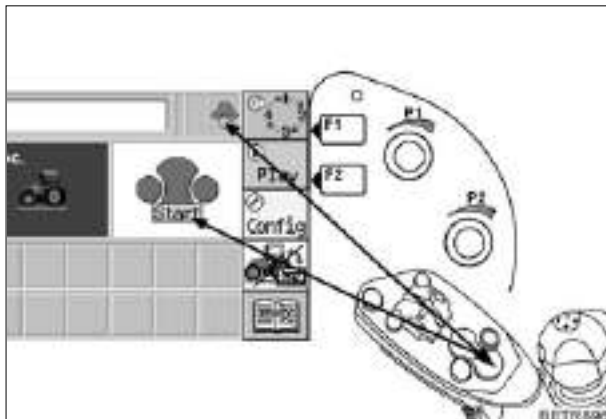

Fig.318

- Use rotary switch (P1) or
- F1 key to specify which joystick button is used for an action (Record, Start, Stop, Pause, etc.).

The active button on the joystick is shown in colour on the Vario terminal.

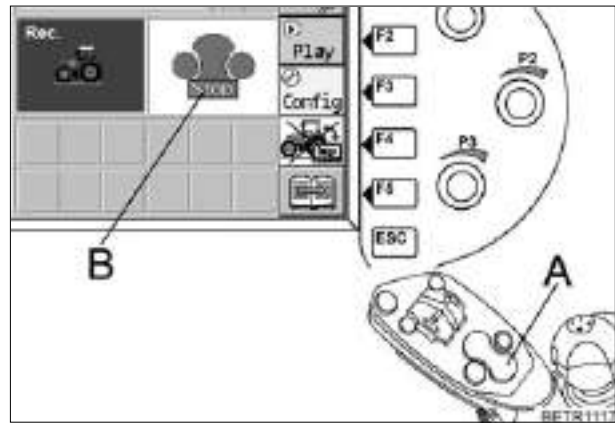

Fig.319

- Press the selected joystick button (A).
- Display (B) changes from START to STOP.

Start recording

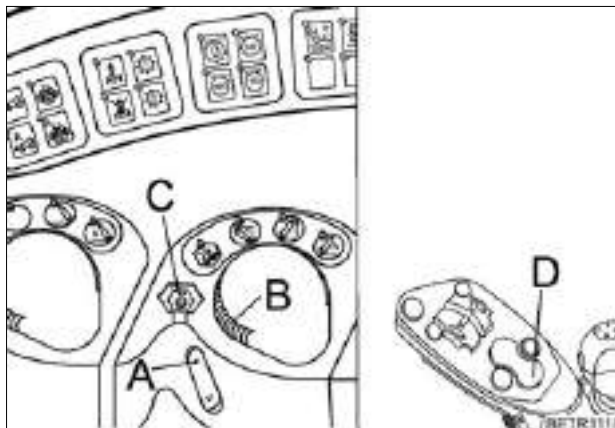

Fig.320

- Lower the rear lifting gear using Quick Lift switch (A), to the position set with the depth control (B).
- At the desired engagement point for the rear PTO, press button (C).
- Press selected joystick button (D) and recording is ended.

When recording has ended, the following sub-menu appears on the Vario terminal.

Play menu level

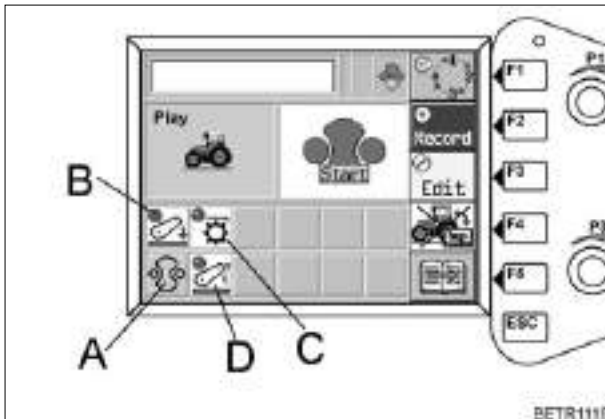

Fig.321

- Indicator (A) for operation with joystick button (when the selected joystick button is pressed, playback starts immediately).
- Indicator (B) for rear lifting gear.
- Indicator (C) for rear PTO.
- Indicator (D) for relative factor for the rear PTO / rear lifting gear lift height.

Recording the second operating sequence

Joystick key assignment

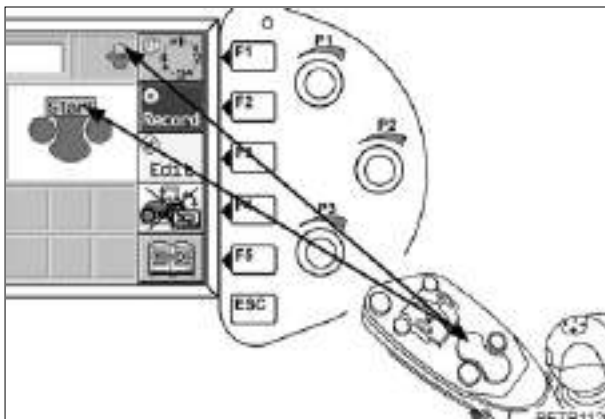

Fig.322

- Use rotary switch (P1) **or**
- F1 key to specify which joystick key is used to control operation (record, start, stop, pause, etc.).

The active button on the joystick is shown in colour on the Vario terminal.



SCH107

Press key (F2). The following submenu appears.

Record menu level

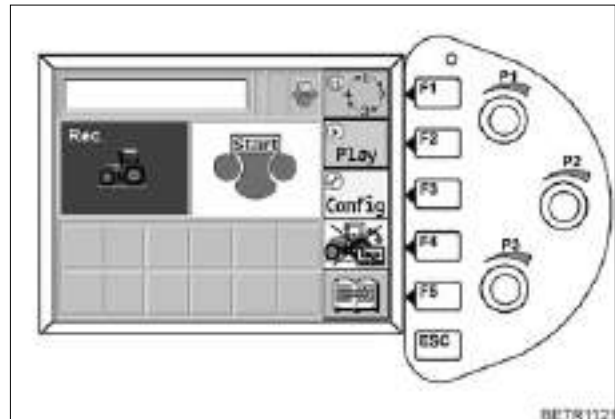

Fig.323

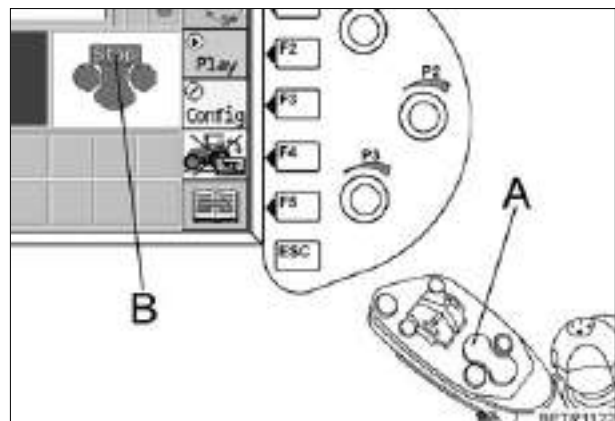

Fig.324

- Press the selected joystick button (A).
- Display (B) changes from START to STOP.

Start recording

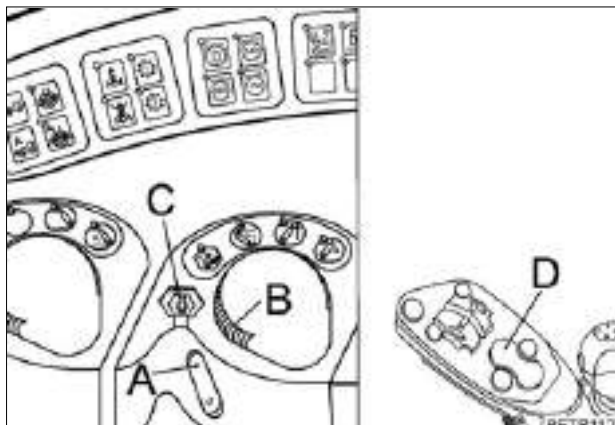

Fig.325

- Lift rear lifting gear to the desired height with the quick lift key (A).
- At the desired disengagement point for the rear PTO, press button (C).
- Press selected joystick button (D) and recording is ended.
- Switch off rear lifting gear with the Quick Lift switch (A).

When recording has ended, the following submenu appears on the Vario terminal.

OPERATION

Play menu level

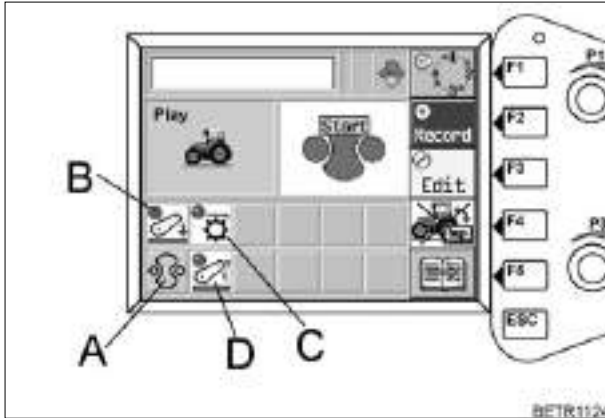

Fig.326

- Indicator (A) for operation with joystick button (after the selected joystick button is pressed, playback starts immediately).
- Indicator (B) for rear lifting gear.
- Indicator (C) for rear PTO.
- Indicator (D) for relative factor for the rear PTO / rear lifting gear lift height.

Playback

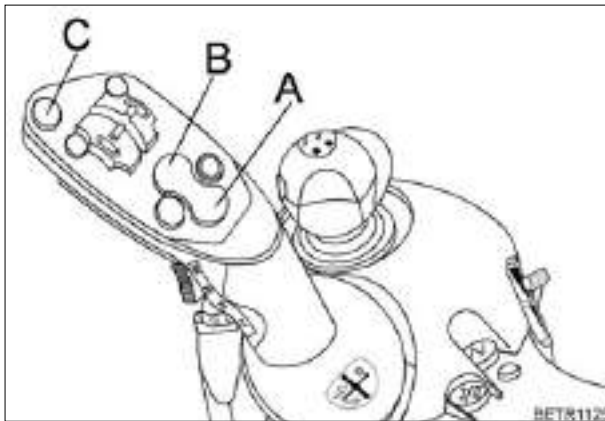

Fig.327

Press button (A)

- Rear lifting gear is lowered, the rear PTO is engaged at the selected lift height.

Press button (B)

- Rear lifting gear is lifted, the rear PTO is disengaged at the selected lift height.

Press button (C)

- STOP.

PAUSE

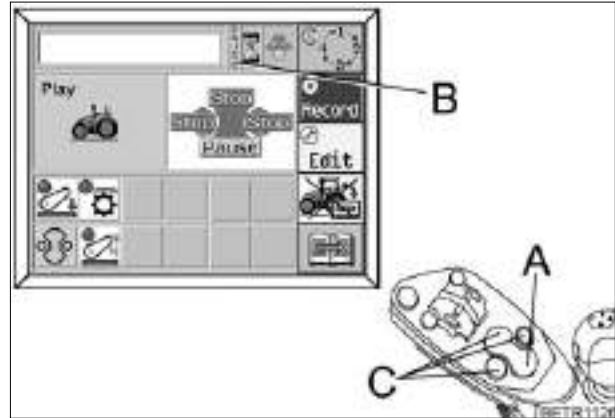

Fig.328

- Hold key (A) pressed down during an operational sequence. The Pause symbol (B) appears.
- Release button (A), Pause mode is ended and the next function is performed immediately.
- Press button (C) to abort an operating sequence.

NOTE:

The changes are not saved.

30.5 Storing data

- Start tractor.



SCH111

Press key (F2). The following menu appears.

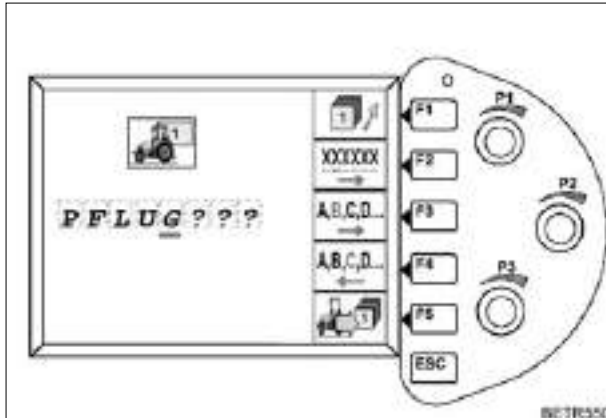

Fig.329

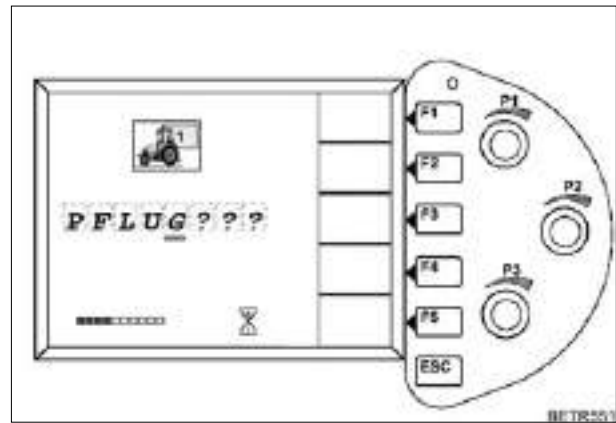

Fig.330

NOTE:
The menu returns automatically to the previous level.



SCH42

Key (F1) to select memory locations 1 - 4.

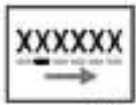

SCH53

Key (F2) to select the location of input characters (letters or numbers).



SCH54

Press key (F3) to scroll characters (letters or numbers) forward (one character at a time).

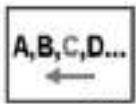

SCH55

Key (F4) scrolls the characters (characters or numbers) backward (one character a time).



SCH56

Quick scroll (selection) forward or backward through characters (letters or numbers), several characters at a time.

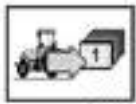

SCH55

Use key (F5) to save settings.

Settings are stored at the selected memory location under the selected name.

The following submenu appears.

OPERATION

30.6 Retrieving stored data



Press key (F1). The following menu appears.

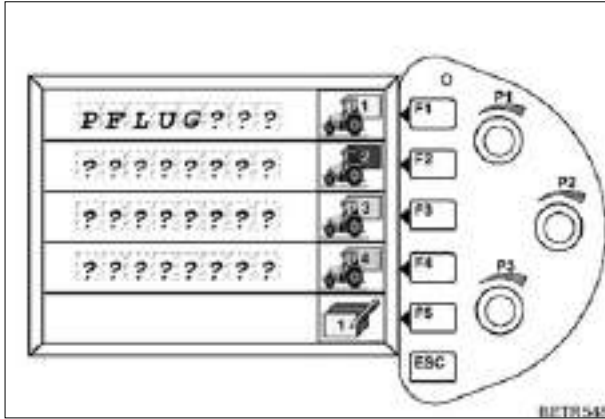

Fig.331

Use keys (F1 - F4) to select operating parameter set.

NOTE:

The menu returns automatically to the previous level.

30.7 Changing operational sequences manually



Press key (F3). The following menu appears.

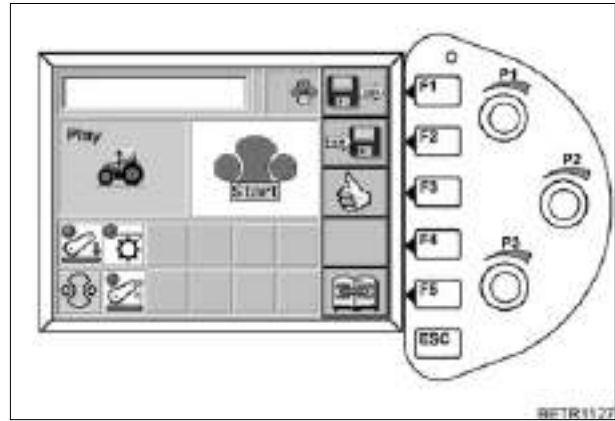

Fig.332

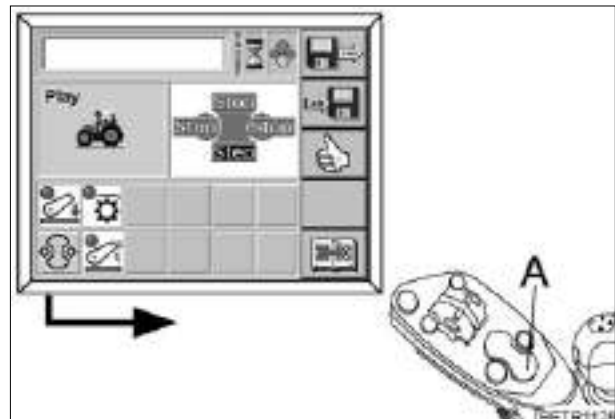

Fig.333

- Press key (A) once - PAUSE.
- Press key (A) again, operational sequences are switched manually using the keys.

The changes are not saved.



Press key (F5)
To change to another menu level.

30.8 Changing relative factors

NOTE:

Only possible in Playback.

The operational sequences can be increased or decreased as required.

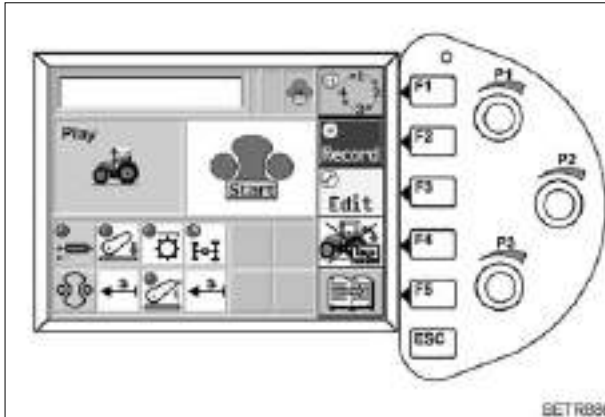

Fig.334



Press key (F3).
The following menu appears.

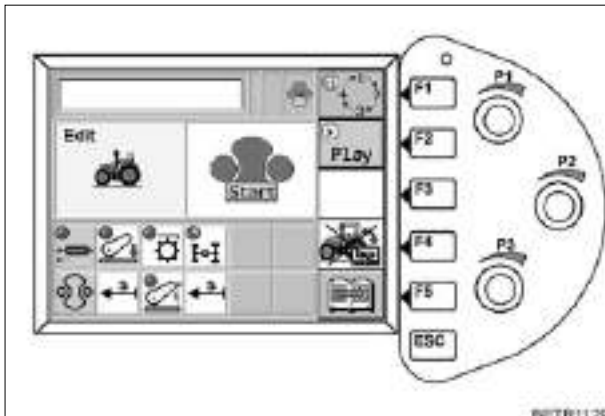

Fig.335

NOTE:

Press F2 key to return to previous level.

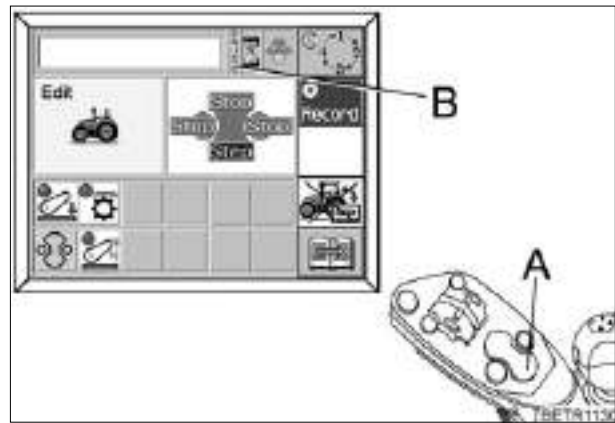

Fig.336

- Hold key (A) pressed down during an operational sequence. The Pause symbol (B) appears.
- Release key (A), pause mode is ended and the next function (e.g. shorter time, longer distance) is performed immediately.

NOTE:

The changes are saved.



Key (F5).
To change to another menu level.

OPERATION

30.9 Modifying configuration lists

There are **four** configuration lists, which can be changed according to the operating conditions.



Use key (F4) to scroll through the configuration lists.

The **factory settings** (Fendt settings) for the configuration lists are:

List 1

Function	Trigger
Lifting gear	Distance
PTO	Lift height
Electric hydraulic valves	Distance
Vario transmission cruise control	Distance
Four-wheel drive	Distance
Differential lock	Distance
Electronic engine speed	Distance

List 2

Function	Trigger
Lifting gear	Time
PTO	Time
Electric hydraulic valves	Time
Vario transmission cruise control	Time
Four-wheel drive	Time
Differential lock	Time
Electronic engine speed	Time

List 3

Function	Trigger
Lifting gear	Manual
PTO	Manual
Electric hydraulic valves	Manual
Vario transmission cruise control	Manual
Four-wheel drive	Manual
Differential lock	Manual
Electronic engine speed	Manual

List 4

Function	Trigger
-	-
-	-
-	-
-	-
-	-
-	-
-	-

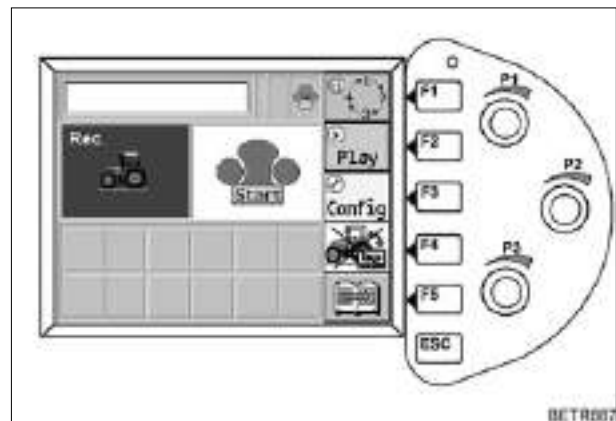

Fig.337



Press key (F3). The following submenu appears.

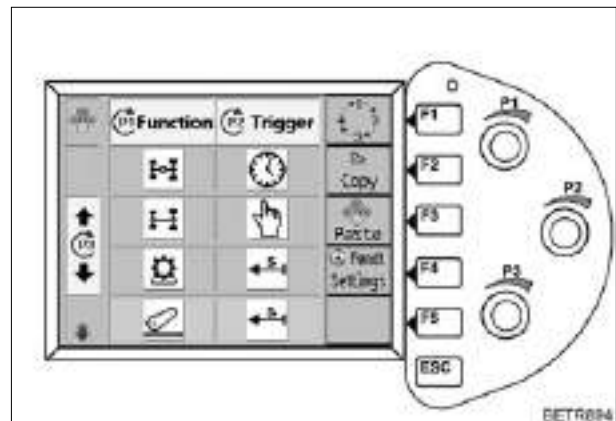
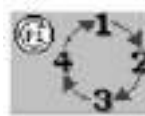

Fig.338



SCH82

Indicator showing the button on the joystick to which the configuration list is assigned.



SCH93

Use key (F1)
To change the key assignment.



Use key (F2)
To copy a configuration list to clipboard.
For example, to save the settings in a configuration list to another button on the joystick.



Use key (F3)
To copy a configuration list from clipboard.



Use key (F4)
To retrieve factory settings.



Rotary switch (P1)
To select a new function.



Rotary control (P2)
To select a new trigger.



Rotary switch (P3)
For the configuration pair that can be changed.



Configuration pair.



Display when there are more than four configuration pairs.
Move up or down using rotary switch (P3).



Press ESC key. Following menu appears (if changes were made).

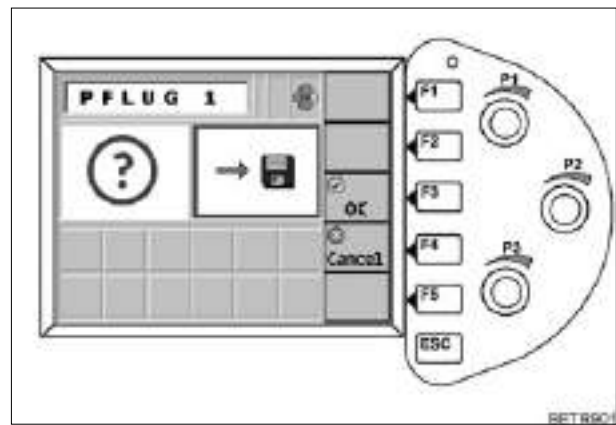

Fig.339

- Press key (F3) if configuration changes are to be saved.
- Press key (F4) if the configuration changes are not to be saved.

IMPORTANT:

If a configuration change is saved, the operational sequence which was created with this configuration list is deleted.

OPERATION

30.10 Function indicator on the main menu

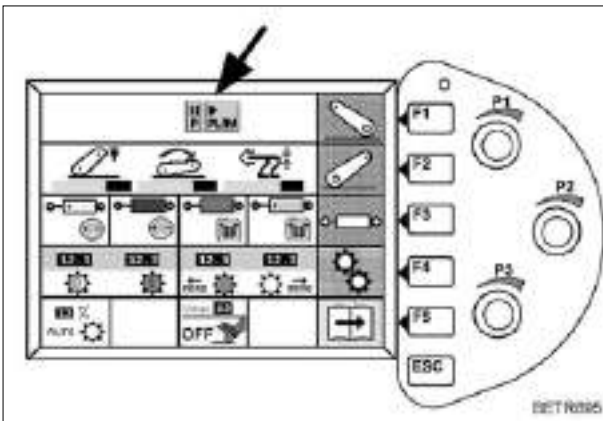
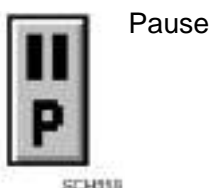
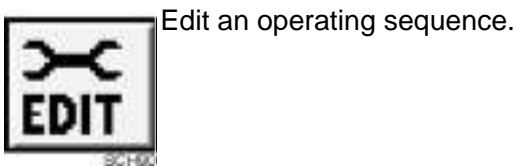
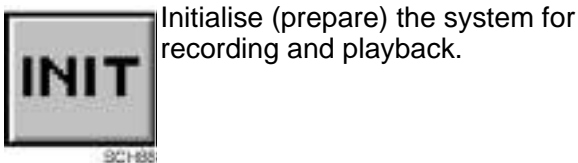

Fig.340



30.11 Menu colours

Colours and what they signify:

- green = PLAY (playback of operational sequences).
- blue = RECORD (record operating sequences).
- yellow = EDIT (edit operating sequences).
- red = Fault or error message.

30.12 Messages for information

If the automatic modes for the power lift and PTO are **not** selected with the Variotronic TI function (see OPERATION Section 14), the following information appears on the multiple display. Power lift and PTO cannot be operated with the Variotronic TI function.

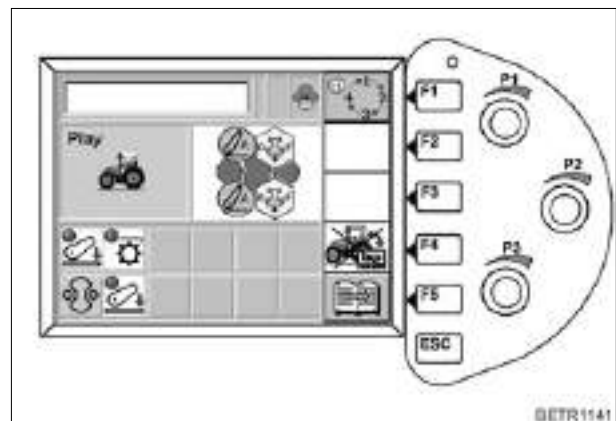

Fig.341

Power lift and/or rear PTO selected.

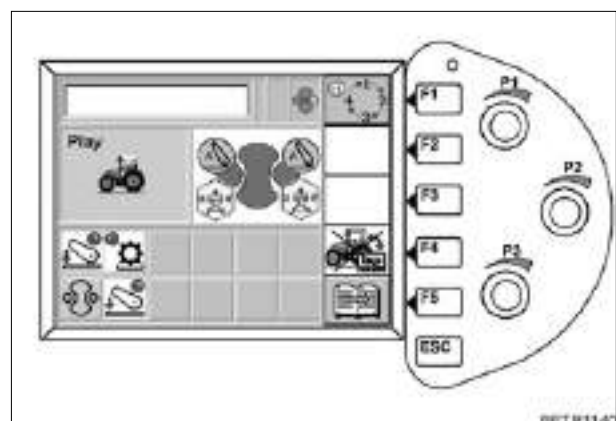

Fig.342

Power lift and/or front PTO selected.

1. General



WARNING:

Before any maintenance or repair work and before opening the bonnet, switch off the engine and remove the ignition key. Apply the hand brake and chock the wheels if necessary. When working on the engine, disconnect the battery at the negative terminal.

When the maintenance work is completed, replace all protective and safety devices. Ensure that the tractor is securely parked.

Ensure that the correct grades of fuel and lubricants are used, and store these in approved containers only. See also **TECHNICAL DATA Fluids and Lubricants**.

Do not perform any welding, drilling, cutting or grinding on the cab or safety frame. All damaged parts must be replaced!

IMPORTANT:

Thoroughly clean the tractor, particularly connections and components that need to be opened, as well as the surrounding areas, before performing any maintenance work. Used oils, cooling- and brake fluids must be disposed as per national laws. Dispose properly according to local environmental regulation and to manufacturer's instructions any used lubricant.

Oil level checks must be conducted when the tractor is horizontal and stationary; if fitted, front axle suspension should be in centre position.

For maintenance intervals, checks to be performed, quantity and quality of lubricants to be used, refer to **Fluids and lubricants** or **Maintenance schedule**.

NOTE:

Picture catalogues of spare parts are available on the internet at the following address.

www.fendt.com

- language

- service

- spare parts catalogue

2. Opening the bonnet

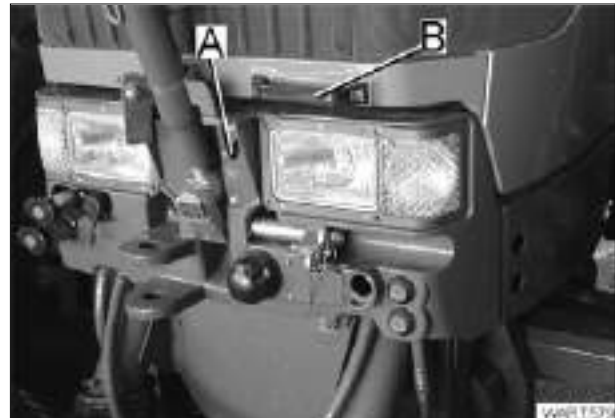

Fig.1

- Release lock (A).
- Use the handle (B) to raise the bonnet.

NOTE:

Swing the bonnet closed with a bit of power.

3. Engine oil change

IMPORTANT:

Engine oil should also be changed prior to long periods of immobilisation.

3.1 Draining engine oil



WARNING:

Take care when draining hot oil risk of burns!
Collect used oil - do not let it seep into the ground.
Dispose of used oil properly.

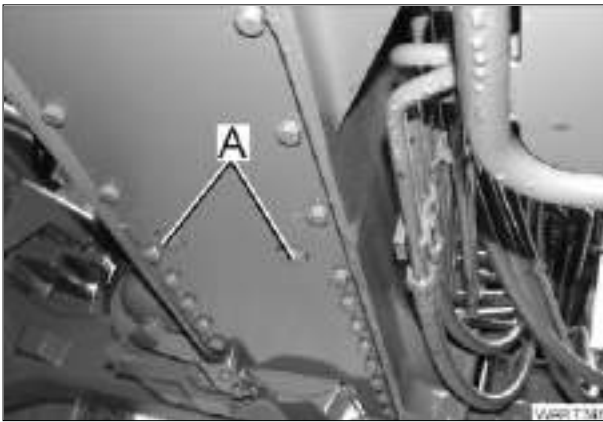

Fig.2

- Warm up the engine.

Oil temperature about 80 °C.

- Tractor must be on level ground.
- Turn off the engine.
- Place a collecting pan underneath the engine.
- Unscrew and remove both drain plugs (A).
- Drain the used oil completely.
- Clean the drain plug and re-insert with a new seal.

3.2 Replacing the engine oil filter



DANGER:

The oil filter may be filled with hot oil - risk of scalding and burn injuries!



Fig.3

Replace the oil filter (A) with every oil change.

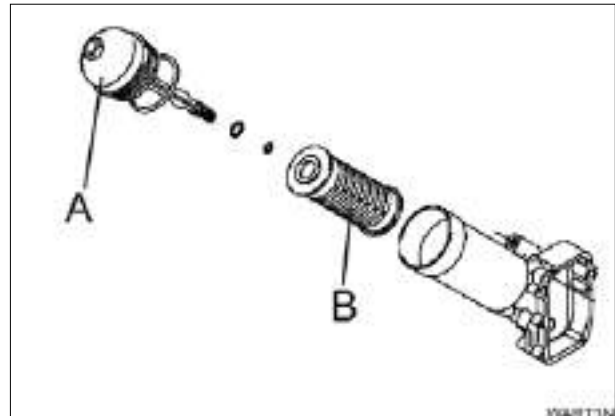

Fig.4

- Turn off the engine.
- Clean away any dirt from the sealing surface of the filter support.
- Place oil collecting pan under the filter, unscrew the filter cover (A) and remove the filter element (B).
- Check the O-ring of cap and threaded rod, and replace if necessary. Clean cover and filter bowl.
- Fit new filter element (B).
- Install filter cap (A) and tighten to 25 Nm.

NOTE:

Used oil filters are hazardous waste.

3.3 Filling with engine oil

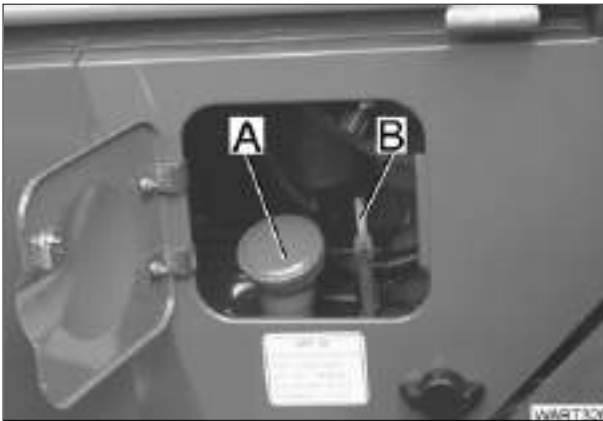

Fig.5

- Fill with the required engine oil through filler neck (A). Ensure cleanliness!

3.4 Checking engine oil level

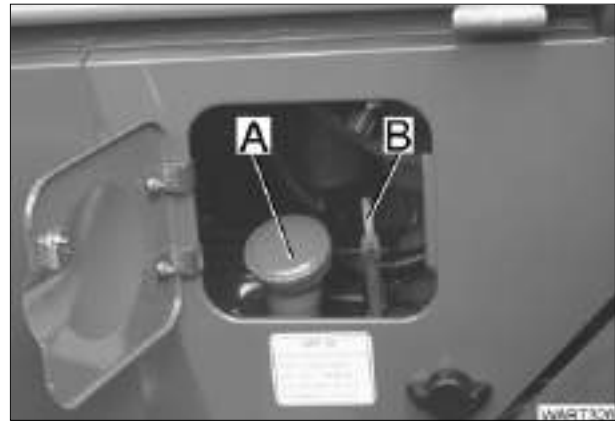

Fig.6

- Tractor must be on level ground.
- Start the engine and allow the engine on idle till the warning indication on the multiple display goes out.
- Check the oil drain plug and filter for leaks.
- Turn off the engine.
- After about 5 minutes, take out the dipstick (B).

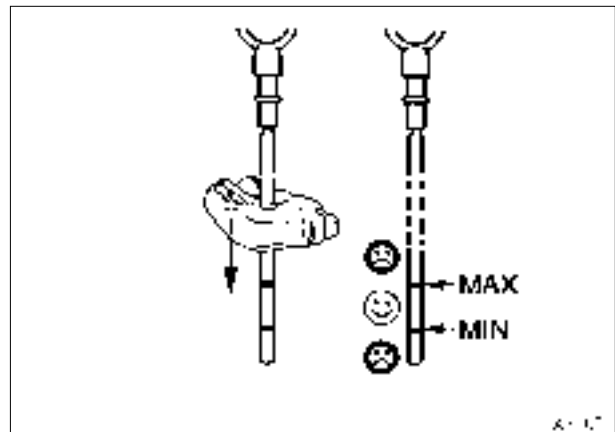

Fig.7

- Wipe dipstick with a clean and lint-free rag.
- Reinsert fully and turn.
- Remove dipstick again.
- Top up if necessary, do not fill above MAX mark.

Oil level must remain between the MIN and MAX marks on the dipstick. Do not fill over the MAX mark.

Difference in engine oil quantities

The difference between MIN and MAX marks on the dipstick represents approx. 5.0 litres.

4. Fuel system



DANGER:
Never allow naked flames when working on the fuel system.
Do not smoke.

4.1 Replacing the fuel filter

Replacement and maintenance as indicated in the maintenance schedule, or sooner if engine performance begins to fall.

Fuel filter

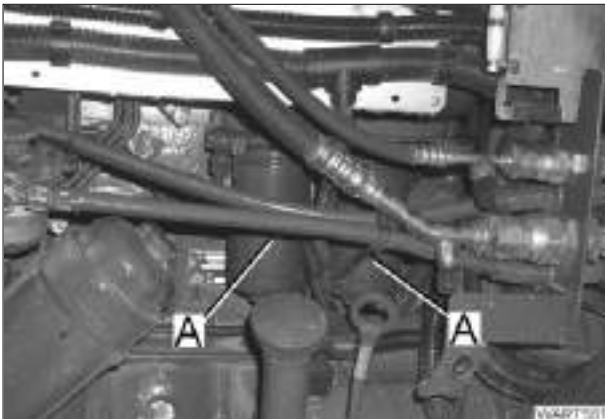

Fig.8

- Turn off the engine.
- Unscrew the filter cartridge (A).
- Collect any escaping fuel.
- Clean away any dirt from the sealing surface of the filter support.
- Lightly oil the oil seals or spray with diesel.
- Tighten the filter cartridge by hand until the seal is in contact.
- Tighten the housing cover by another half turn (to 25 Nm).
- Start engine. Check for leaks.

NOTE:

Used fuel filters should be treated as special waste.

Fuel filter - manual displacement pump



Fig.9

- Turn off the engine.
- Unscrew the housing cover.
- Collect any escaping fuel.
- Clean away any dirt from the sealing surface of the filter support.
- Change the filter element.
- Lightly oil the oil seal or spray with diesel.
- Tighten the housing cover.
- Start engine.
- Check for leaks.

4.2 Bleeding the fuel system



Fig.10

- Pull out manual pump plunger (arrowed), then push in until fuel is delivered, then give the pump about 30-50 strokes.
- Start engine.

NOTE:

If bleeding, do not open any fuel injection lines, the fuel injection lines will have to be replaced.

4.3 Fuel prefilter

(optional).

To drain water and dirt

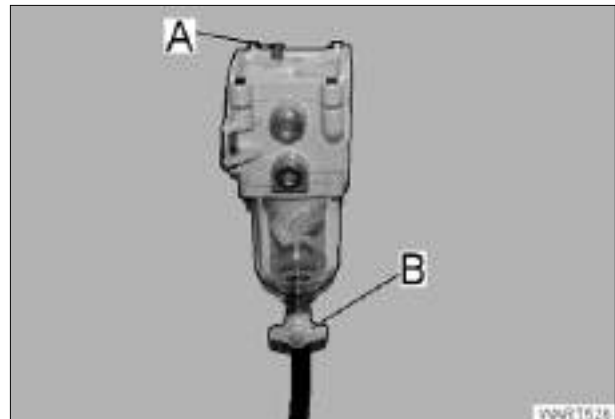

Fig.11

- Turn off the engine.
- Open the ventilation screw (A).
- To open drain plug (B), press and turn.
- Drain water and contamination. Catch it with an appropriate drip tray and dispose of it in an environmentally friendly manner.
- Close the ventilation screw (A).
- Close drain plug (B).
- Start engine. Check fuel prefilter for leaks.

Changing the filter

(as required, when engine output starts to fall).

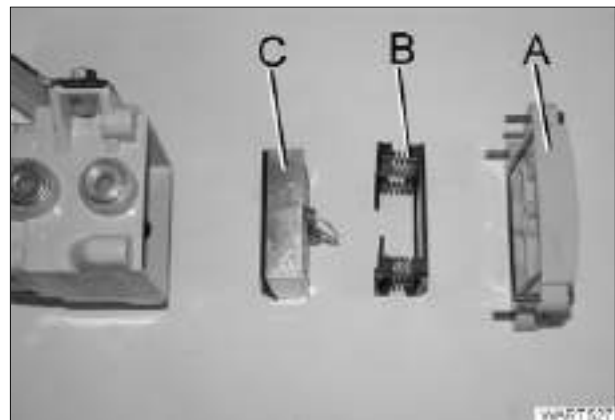

Fig.12

- Turn off the engine.
- Unclamp the fuel supply line.
- Unscrew the filter cover (A).
- Remove spring housing (B).
- Take out filter (C). Insert new filter.
- Insert spring housing (B).
- Tighten the filter cover (A).
- Start engine. Check fuel prefilter for leaks.

5. Dry air filter

5.1 Vacuum check



Fig.13

Function check:

- Remove cable connector (A) from vacuum switch and connect to ground.
- Turn ignition key to position I.



Fig.14

The vacuum check symbol should now appear on the multiple display, accompanied by an intermittent audible signal and a flashing warning light.

- Check air filter intake hoses and intake system for leaks, and tighten the connections if necessary.

5.2 Removing/installing the main cartridge

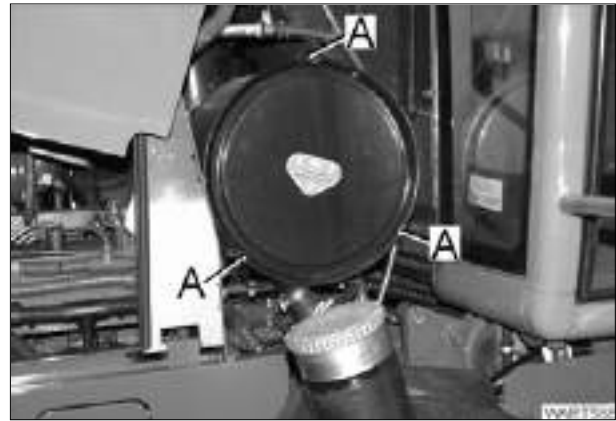

Fig.15

- Undo fasteners (A) and remove the cover.



Fig.16

- Pull out main cartridge (A).
- Clean filter housing; ensure sealing faces are free of defects.
- Insert main cartridge and attach the cover.

NOTE:

The main cartridge must be replaced after 5 cleanings, or after 2 years at the latest.

5.3 Cleaning the main cartridge



Fig.17

Provisional cleaning by tapping:

- Tap the cartridge with the heel of the palm only.

Cleaning by blowing out:

- Blow out the filter from the inside out, with dry compressed air (maximum 5 bar, at a minimum distance of about 5 cm).
- Carefully blow the air through the inside of the cartridge.

NOTE:

Check the filter cartridge is in perfect condition after every cleaning. external damage, leaks, damaged paper bellows (light shine from the inside).

5.4 Replacing safety cartridge

Only replace after the main cartridge has been changed 3 times, or if the main cartridge is damaged.

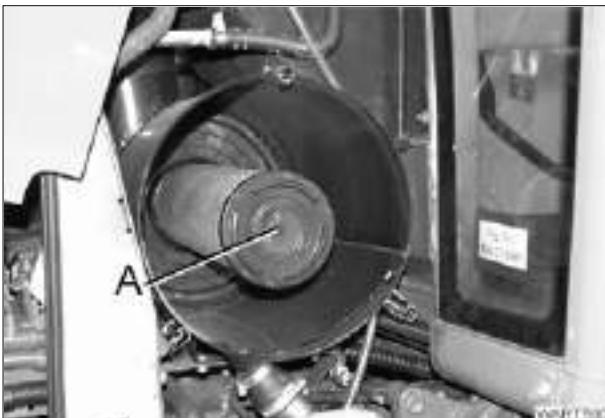

Fig.18

- Pull out safety cartridge.
- Ensure cleanliness! The clean air duct must be kept free of dust particles.

6. Cooling system

6.1 Cleaning the cooling system

Cleaning the radiator

The fins on the radiator, hydraulic oil cooler, fuel cooler, transmission oil cooler and air conditioning system (if installed), should be kept clean. The same applies to protective grille, and front and side grilles.



Fig.19

- Open front bonnet.
- Tilt air conditioner condenser up and lock in this position.
- Remove metal panel (A).
- Carry out the cleaning from the engine side using a long-handled brush or compressed air.
- For stubborn dirt, pre-clean with a soft brush using a suitable cleaning solution (e.g. 'P3'). Leave to soak for about 5 minutes then rinse with a gentle water spray.

Cleaning the viscous fan



Fig.20

- Keep the fins of the viscous fan (arrowed) clean.
- Do not cover radiator, otherwise the fan would not cut in.

CARE AND MAINTENANCE

6.2 Checking the coolant level

CAUTION:
When the engine is hot, take extreme care when removing the radiator cap and left hot steam escape. The coolant is under pressure - risk of scalding.



Fig.21

Level between MIN and MAX mark on the expansion reservoir.



Fig.22

- Only top up with clean, calcium-free water with antifreeze (glycol) through filler necks (A).

Check concentration of coolant. Check for eventual leaks on hose connections (heating system too!).

NOTE:

The antifreeze solution also contains inhibitors to protect against cavitation and corrosion. A minimum concentration of 35 - 50 vol. % antifreeze and anticorrosive is therefore necessary throughout the year, even in frost-free areas.

6.3 Replacing coolant

DANGER:
Turn off the engine!

Replace coolant at least every 2 years.

Draining coolant from the radiator

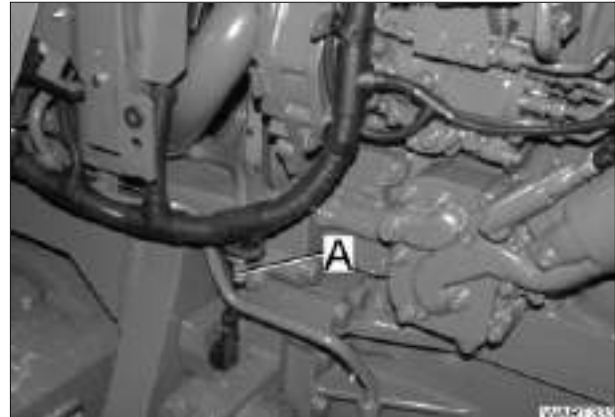

Fig.23

- Open the cap on filler neck.
- Switch on the heater.
- Position drain pan under engine.
- Unscrew screw (A) and remove and allow coolant to run out.

Filling with coolant

- Mix antifreeze solution with clean, demineralised water and fill to the level of in the expansion tank.
- With the heater switched on, run the engine for about 10 minutes (at about 1,500 rpm).
- When the engine has cooled down, check the coolant level and top up if necessary.

6.4 Cleaning the cooling/heating system

If the coolant is badly contaminated, i. e. with rust or grease, use only hot cleaning solution (e.g. 'P3') to flush the cooling system.

- Run the engine for about one hour, filled with the cleaning solution.
- Flush out with clean water and top up with coolant solution.

7. V belt



DANGER:
Check the V-belt tensioner only with the engine stopped! Mount the protective grille again.

7.1 Right hand V belt

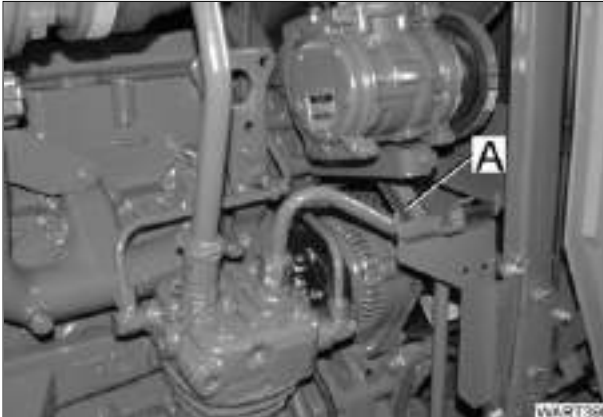

Fig.24

The poly-V-belt (A) has an automatic belt tensioner.

- Check for cracks, oil fouling, signs of overheating and wear.
- Replace damaged belts.

The tension pulley must be replaced every time the V ribbed belt needs to be replaced.

Air conditioning compressor V-belts (see CARE AND MAINTENANCE Section 17.2).

Setting V-belt belt tightener

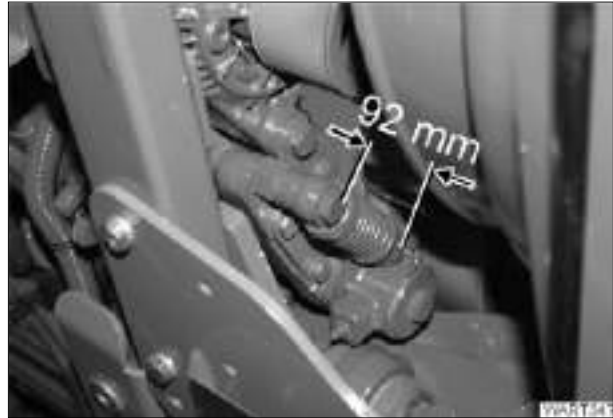

Fig.25

- Setting as delivered of distance between centres A = 92 mm.
- Re-adjustment with max. distance A = 100 mm to A = 92 mm.
- If the distance reaches A = 100 mm again, then replace power belt.

NOTE:

A gap between lugs (dimension A) of more than 100 mm can lead to total failure of the belt drive due to insufficient belt tension.

7.2 Left V-belt

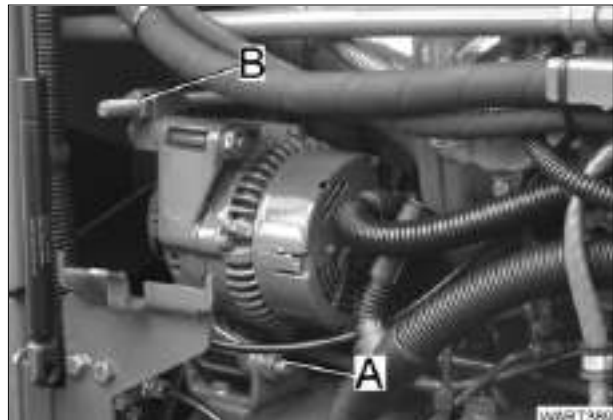

Fig.26

V-belt tension is to be measured at the centre point between pulleys, using Optibelt tension gauge I.

- Loosen alternator nut (A).
- Adjustment with clamping screw (B).

Strand pull (operating tension)
450+50 N (45+5 kp).

8. Brake and clutch system



DANGER:

The brake system should be checked thoroughly at regular intervals.

Brake system adjustment and repair operations should be performed by specialised workshops or authorised brake services!

If there is continuous loss of hydraulic oil from the brake and clutch system, contact the Service Workshop.

Reservoir in the steering column



Fig.27

- Fill up the reservoir (arrowed) to 'MAX' using only hydraulic oil Pentosin CHF 11S.

Oil level switch

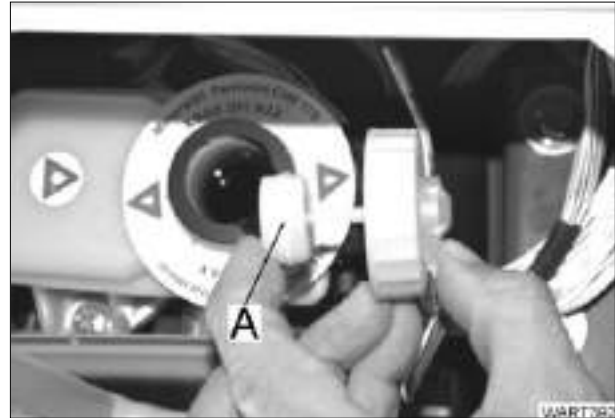

Fig.28

Function check:

- Unscrew and remove the cover.
- Bring float (arrowed) to lowest position.
- Turn ignition key to position 'I'.



Fig.29

The 'brake fluid level' symbol must appear on the multiple display, with intermittent audible signal and warning lamp flashing.

NOTE:

The clutch and brake system is maintenance-free!

9. Front PTO

Front PTO oil level

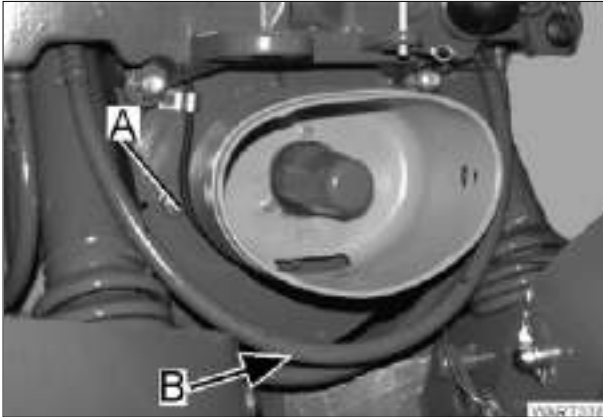

Fig.30

- Fill oil through filler hole (A).
- Oil drain screw (B).

Oil level: fill up to overflow at filler hole (A).

10. Transmission and axle drives

10.1 Changing the transmission oil

Change the oil only when the transmission oil is warm.

Draining the transmission oil



Fig.31

- Place oil drip pan underneath the transmission.
- Unscrew drain plug (A), remove and allow oil to drain completely.
- Clean the drain plug, refit and tighten.

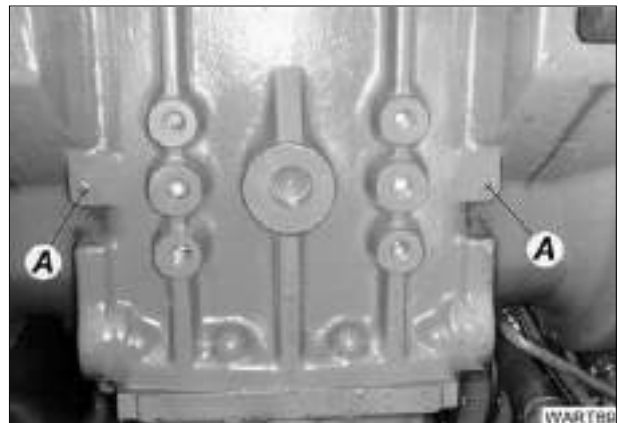

Fig.32

- Unscrew drain plugs (A) on either side of the brake housing and allow oil to drain completely.
- Clean the drain plug, re-insert and tighten.

CARE AND MAINTENANCE

Replacing pressure filter

A soiled pressure filter (A) is indicated by a warning message (see also FAULTS AND REMEDIAL ACTIONS Section 1.1). Replace the filter element as soon as possible, but not later than every 1000 operating hours.

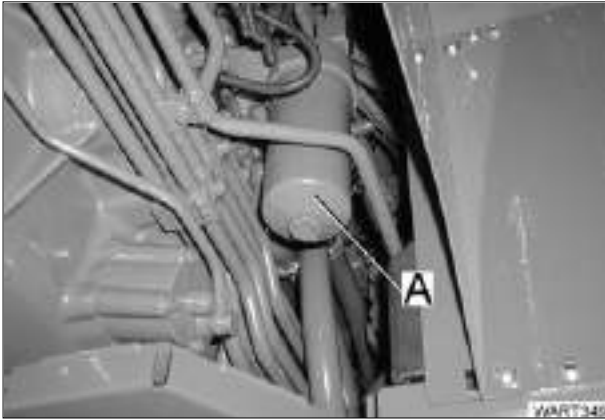

Fig.33

- Unscrew the filter housing (A).
- Withdraw the filter element from housing.
- Replace the filter element, do not wash out.
- Lightly oil the sealing rings.
- Put filter housing back in place and tighten screw (to 40 Nm).

Replacing intake filter



Fig.34

- Remove cover (A) and extract the intake filter.
- Replace the spin-oil filter.

Filling gear oil

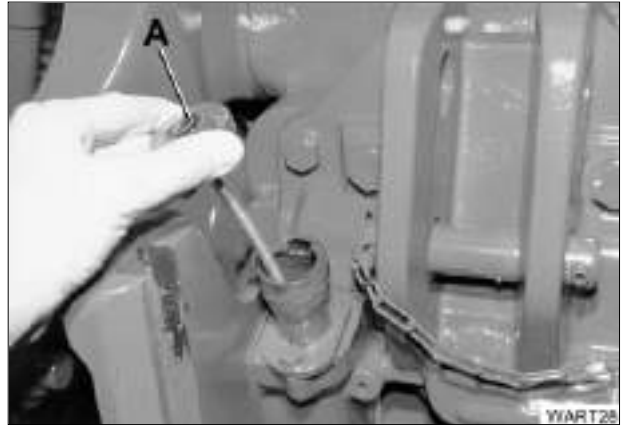

Fig.35

- Remove dipstick (A) and pour oil through the filler hole.

10.2 Checking the transmission oil level

- Tractor must be on level ground.
- Twist the dipstick and pull out.
- Wipe the dipstick using a clean, fibre-free rag.
- Reinsert dipstick fully and twist into place.
- Twist the dipstick and remove again.

The oil level must reach the upper notch on the dipstick.

Difference in oil volume between min. and max. marks on dipstick is approx. 3 litres.

10.3 Changing the oil in the axle drives

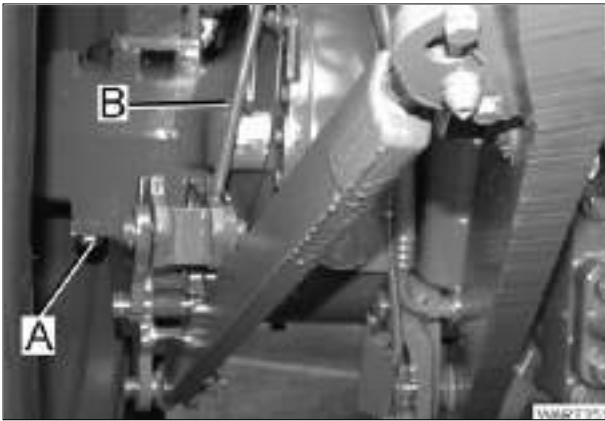

Fig.36

- Place an oil drip pan underneath the transmission.
- Unscrew drain plug (A), remove and allow oil to drain completely.
- Clean the drain plugs, re-insert and tighten.
- Pour in the required oil through filler hole (B) on the left and the right axle carrier.

Oil level must be up to overflow at filler hole (B).

11. Four-wheel drive axle

11.1 Changing the oil in the front axle differential gear

Draining the oil

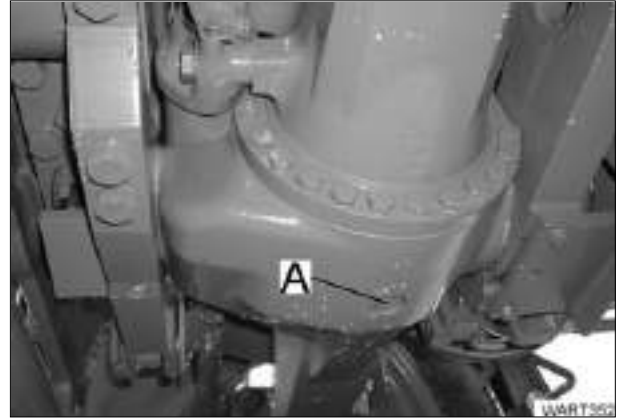

Fig.37

- Place an oil drip pan underneath the transmission.
- Unscrew drain plug (A), remove and allow oil to drain completely.
- Clean the drain plug, refit and tighten.

Filling with oil

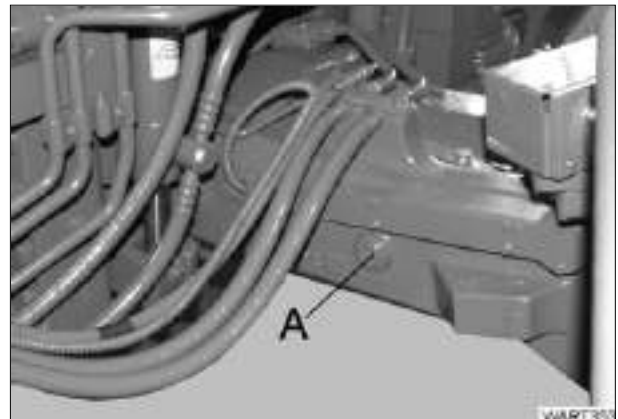

Fig.38

- Pour in the required oil through filler hole (A).
- Oil level must reach the overflow at filler hole (A).

CARE AND MAINTENANCE

11.2 Replacing the oil in front axle hub drives

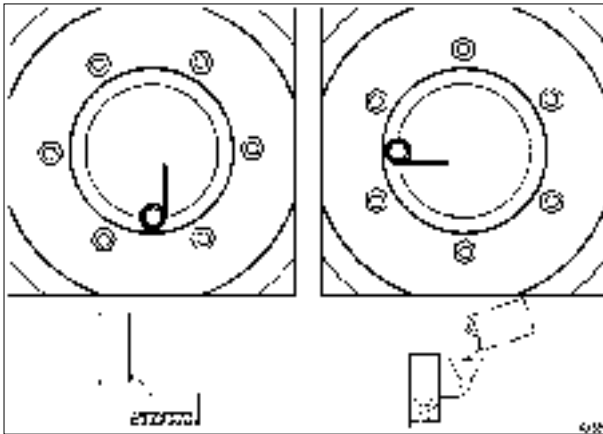

Fig.39

To change the oil, jack up front axle until wheels rotate freely; disengage the 4WD.

Draining the oil

- Turn wheel until the hole is at the bottom.
- Place collecting pan underneath.
- Remove drain plug and allow the oil to drain completely.
- Clean the drain plug, refit and tighten.

Filling with oil

- With hole on the left and marker in horizontal position, fill with oil up to the overflow.

11.3 Front axle suspension



WARNING:

Even with the engine switched off and the load removed from the front axle, hydraulic lines of the front suspension are under pressure. Always relieve pressure before undoing connections! When checking for leaks, to avoid injury, use suitable material (e.g. a piece of wood).

Relieving pressure from hydraulic lines

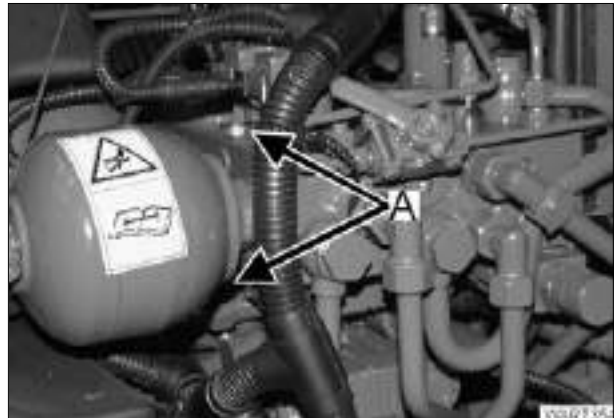

Fig.40

- Remove cover plates from right of doorway.
- Open plugs (A).

12. Power lift

Checking oil level in power lift

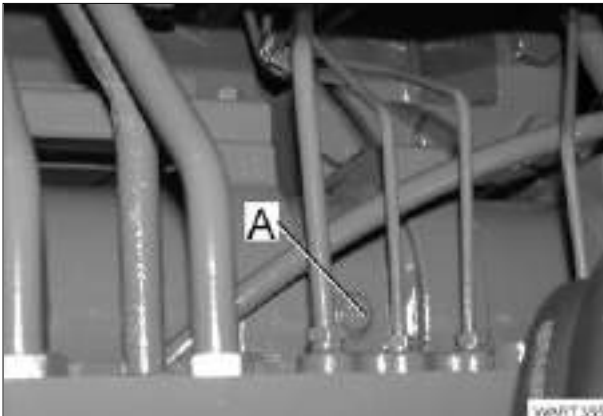

Fig.41

- Unscrew plug (A).
- Check oil level with a test strip (e. g. cable tie).

The oil level must be approx. 40 mm (vertically) below the bottom edge of the filler hole.

13. Hydraulic system



DANGER:

When working on the hydraulics, always switch off the engine and ensure that the tractor is safely parked (hand brake applied, wheels chocked).

The system is under high pressure. Ensure that all pressure is released, and that mounted implements are lowered before any work is carried out on the hydraulics.

When checking for leaks, to avoid injury, use suitable material (e.g. a piece of wood).

Regularly check hydraulic hoses, and replace if they show signs of damage or ageing! Replacement hoses must meet the technical requirements of the implement manufacturer!

Always ensure the utmost cleanliness when working on hydraulic components.

13.1 Checking oil level in hydraulic system

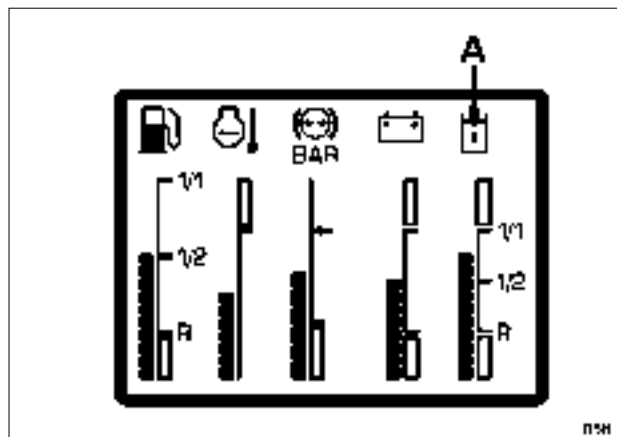

Fig.42

The level (A) in the hydraulic oil reservoir oil level is shown on the dashboard. When filling with oil to MAX, the rear power lift must be lowered and all cylinders retracted.

CARE AND MAINTENANCE

13.2 Changing the hydraulic oil

IMPORTANT:

Always use only clean oil, containers and funnels.

Oil must meet the cleanness standard of filter class 10 in accordance with NAS 1683.

Change the oil when the oil in the system is warm, the power lift is lowered, and all cylinders are retracted.

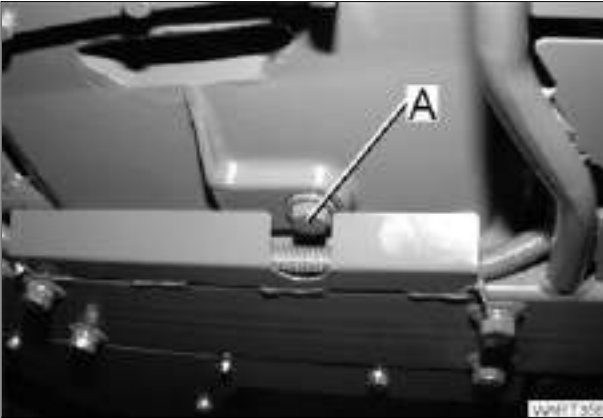

Fig.43

Draining the oil:

- Place oil drip pan underneath the hydraulic reservoir.
- Unscrew and remove drain plug (A) and allow the oil to drain.
- Clean the drain plug, refit and tighten.



Fig.44

Filling with oil:

- Preferably fill in the oil through a return flow coupling using a pump.

This way the oil is filtered.

13.3 Hydraulic oil filter

Replacing the return line filter



Fig.45

Remove the cover panel on right of entrance.

- Unscrew the filter cover (A).

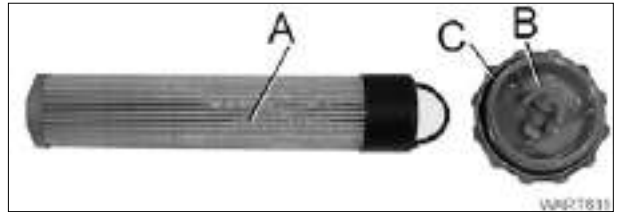

Fig.46

- Pull out main cartridge (A).
- Insert new filter cartridge (hole downwards).
- Insert new flat seal (B) in filter cover (C).
- Screw on filter cover (C).

Replacing air vent filter

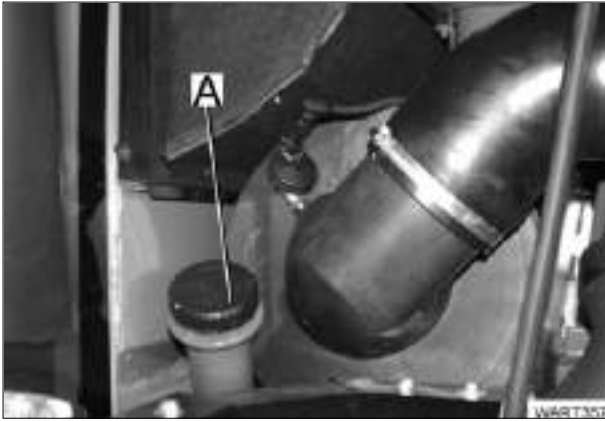

Fig.47

- Unscrew and remove air vent filter (A) and screw in a new filter.

NOTE:

The vent filter cannot be cleaned.

Replacing the control pressure fine filter

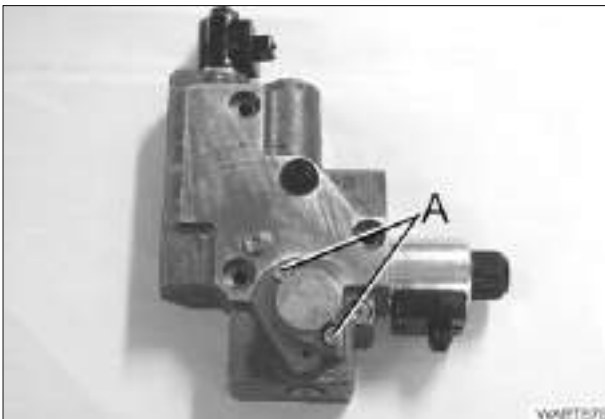

Fig.48

- Unscrew the threaded connection (A) on the valve end plate.

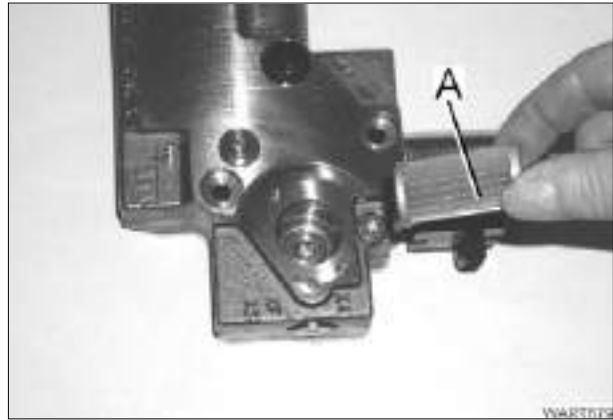

Fig.49

- Change the fine filter (A).
- Screw in the threaded connection (see CARE AND MAINTENANCE Fig. 48 /A) and tighten to 5.5 +1.8 Nm.

NOTE:

Ensure the utmost cleanliness when cleaning the fine filter.

Minute particles of dirt in the control circuit can affect the functioning of the work hydraulics.

Temperature warning device

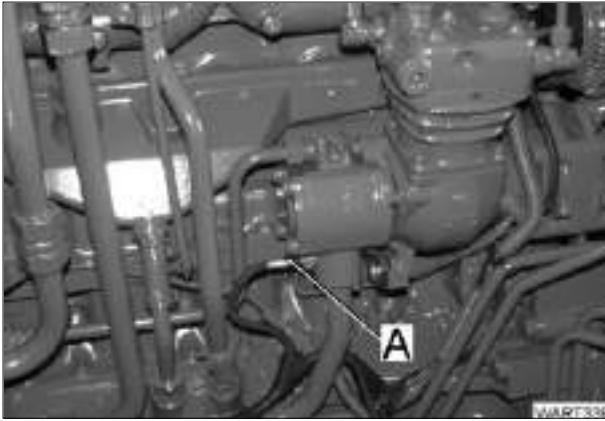

Fig.50

If oil temperature is too high, this is indicated by a warning message, (see also FAULTS AND REMEDIAL ACTIONS Section 1.1).

Function check:

- Detach cable connector (A) from the temperature switch and connect to ground.
- Turn ignition key to position 'I'.



Fig.51

'Hydraulic oil temperature' symbol is shown on multiple display, with warning lamp flashing and intermittent tone.

14. Steering

Regularly check the steering for leaks and signs of damage, check that the sealing bellows are in good condition, and check the hoses for chafing marks.

15. Front wheels

15.1 Checking toe-in

After initial 50 operating hours, then every 500 operating hours.

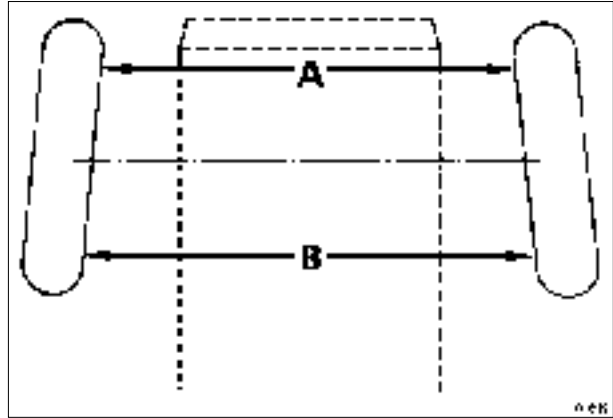

Fig.52

Toe-in should be 0 - ± 1 mm.

- Steering straight ahead; Average axle load.
- Measure distance between tyres on the wheel hub at the front rim flange (A).
- Push tractor forward by 1/2 turn of the front wheels.
- Measure distance between tyres on the wheel hub at the rear rim flange (B).

16. Heating and ventilation

Clean the paper filter (by blowing or tapping out) about every six months or if fan output begins to fall. Dry out if necessary.

Replace the paper filter if damaged. Do not switch on the heater fan during spraying operations.

16.1 Removing the heater fan filter

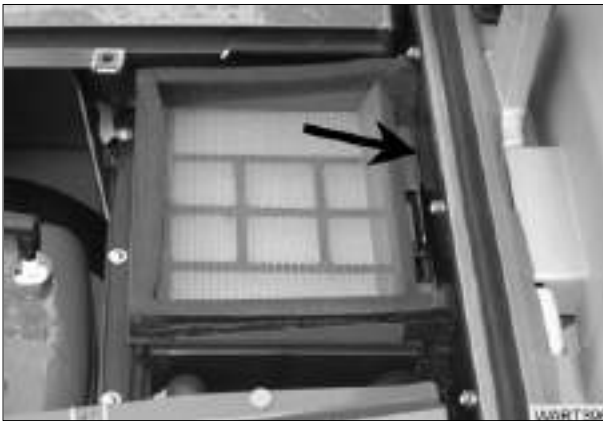

Fig.53

- Unscrew and remove the cover.
- Push latch (arrow) down and remove the filter.
- Ensure the correct positioning when installing.

16.2 Replacing the roof fan filter



WARNING:

A used pollutants filter may contain traces of spraying agents. Replace with a normal filter cartridge as soon as possible after every spraying operation.

Read the instructions leaflet supplied with the filter.

Cab and filter do not guarantee 100% protection against harmful chemicals.

Keep the cab closed when using sprays. Install a pollutant filter.

Observe the filter manufacturer's maintenance instructions.



Fig.54

- Unscrew the screw plugs (arrowed), and flip the panel upwards.



Fig.55

- Pull retaining clip (A) upwards.
- Open the clips (B) and take out the filter together with the filter frame.

NOTE:

When closing, first disengage the retaining clip.

16.3 Replacing the recirculating air filter

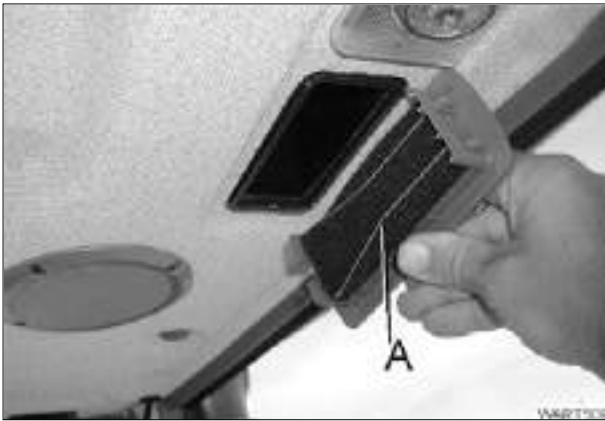

Fig.56

- Dismount air nozzles (right and left) and remove filter (A).

17. Air conditioning

Switch on the air conditioning once a month (even in winter) for about 10 minutes, setting the ventilation to recirculated air mode (see OPERATION Section 3.2).

Clean roof fan filter and recirculating air filter (see CARE AND MAINTENANCE Section 16).

17.1 Condenser

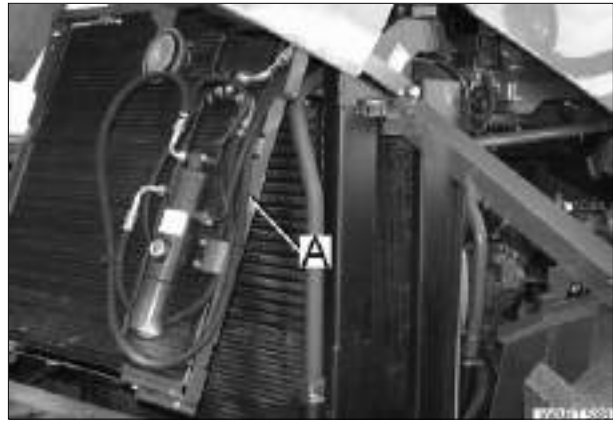

Fig.57

- If dirty, blow through or spray the condenser (A) from the inside.

Checking coolant level

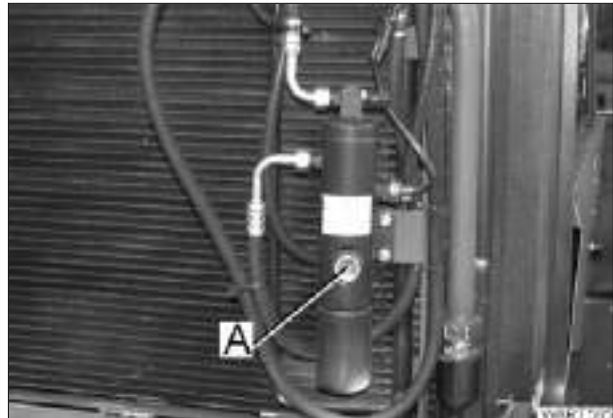

Fig.58

- Switch on system. The compressor must also be running. At an engine speed of 2,000 rpm; white ball (A) in the sight glass of the fluid tank must float.

Topping up with coolant or replacing the tank / dryer can only be undertaken in the workshop.

NOTE:

The blue ball turning pink indicates moisture in the system.

17.2 Compressor V-belt



Fig.59

V-belt tension is to be measured at the centre point between pulleys, using Optibelt tension gauge I.

- Adjustment is made with clamping screw (A).

Span force (operating tension)
400 + 50 N (40 + 5 kp) - profile 13 mm.

18. Windshield washer system

Cleaning agents and antifreeze can be added according to the manufacturer's instructions.

Fluid reservoir

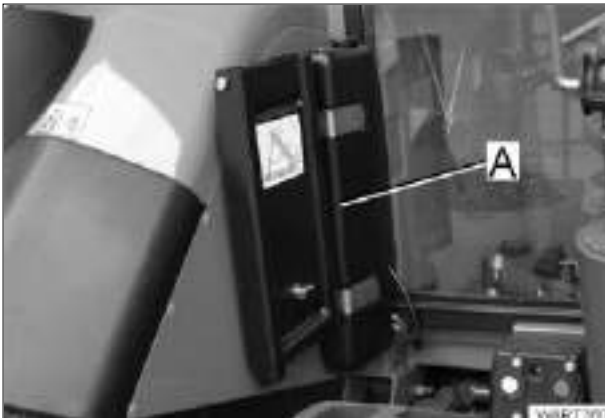

Fig.60

- Top up fluid in reservoir (A).

19. Cleaning the tractor

- The driver seat upholstery sections can be removed by unbuttoning, without tools.
- Never leave the engine running when hosing down the tractor.
- Never point water jets directly at electrical equipment.
- When using a high-pressure washer, maintain a distance of at least 10 cm. from seals and paint work. Maximum water temperature 50° C. Do not use a spray booster (dirt cutter). Always follow the manufacturer's instructions.
- After cleaning the tractor, lubricate all lubrication points, joints and bearings. We recommend waxing painted surfaces after cleaning.
- Do not aim high-pressure cleaning jets directly at the radar sensor (minimum distance 1 m.- maximum pressure 65 bar).

19.1 Clean the cab's air spring bellows



Fig.61

To ensure proper function of the cab air suspension, the air spring bellows (arrowed) must be cleaned if dirty.

Clean with high-pressure washer, keep a distance of at least 10 cm to seals and paint. Maximum water temperature 50° C. Do not use a spray booster (dirt cutter).

CARE AND MAINTENANCE

20. Electrical and electronic systems

Since even a test lamp can damage electronic components in the electrical system, trouble shooting must always be carried out in the workshop.

Disconnect battery if the tractor is not used for long periods, to prevent it being discharged by small consumers. Check the battery charge level every 2 months. Do not operate the tractor without a battery.

In the following conditions, stored settings (for example, the speed indicator setting) are lost and are replaced by the default values:

1. Drained or disconnected battery.
2. White connector 1 disconnected from instrument cluster.

20.1 Battery



WARNING:

When working on the electrical system, always disconnect the battery (negative terminal). Use the correct connecting sequence - connect first plus terminal and then minus terminal. Beware of battery acid caustic! Beware of battery gases! Avoid sparks and naked flame near the battery. The glass on work lamps are very hot while switched on!



Fig.62

Acid level approx. 15 mm above the top of the plates.

- Top up with distilled water when necessary.

Not necessary with sealed batteries. Keep battery clean!

Keep battery in good charging condition - especially in cold weather.

Do not operate the tractor without a battery.

20.2 Alternator

Charge control lamps go out after starting at approx. 1,000 rpm.

20.3 Electrowelding

Disconnect both battery terminals. Keep ground terminal as close to the point of welding as possible; be aware of components sensitive to temperature.

20.4 Adjusting the headlights



CAUTION:

Before adjusting, bring the tractor front axle suspension to centre position of the total suspension range (see also OPERATION Section 13).

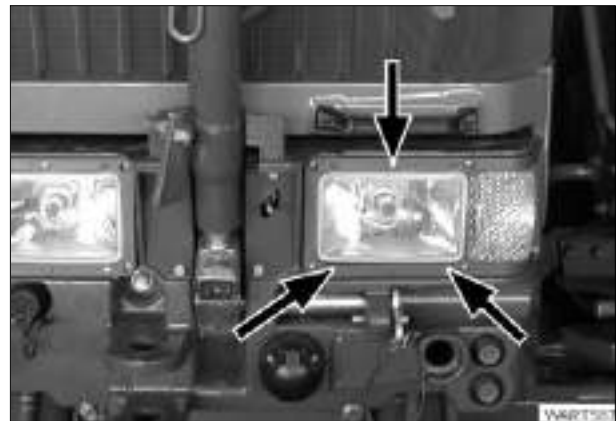

Fig.63

- Adjust headlights using the Phillips screws (arrows).

20.5 Adjusting the auxiliary headlamps

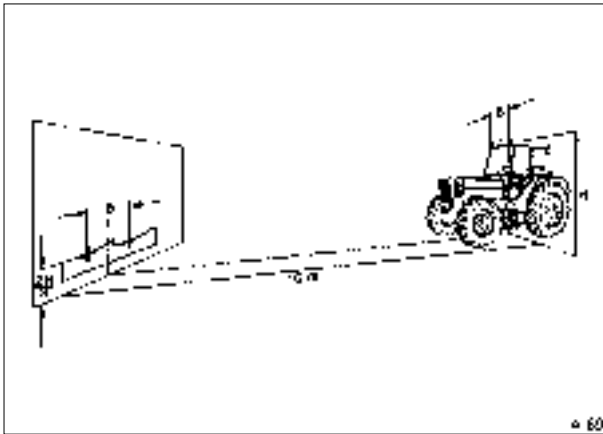

Fig.64

At a 10 metre distance the upper limit of the illuminated area is two thirds of the height of the tractor lights.

20.6 Auxiliary lights, Xenon headlights



DANGER:
Always pull out connector (A/ CARE AND MAINTENANCE Fig. 65) when carrying out maintenance and repair work.

Xenon headlights



Fig.65

To be remembered when operating the headlamps.

- Headlamps develop a lot of heat. Fire hazard.
- Do not look directly into the light.
- Clean the glass from time to time, but only when they are cold.
- Do not clean the glass with fluid when the lamps are on. Danger of shattering!

- Do not use aggressive or abrasive cleaning agents.
- Do not operate on public roads.

To be remembered when replacing the bulb.

- Always turn off the headlamps and disconnect the supply voltage before changing the bulb.
- Do not reach into the bulb socket.
- The connection between headlamp and connection unit carries high voltage. Do not disconnect!
- Do not operate transformer unit without a bulb. Flashovers at the bulb socket can cause damage.
- Allow bulb to cool.
- When changing the bulb, wear safety glasses and gloves.
- The glass body of the bulb is under pressure. Danger of splitters!
- Only touch bulb at the base.
- Remove dirt from the glass with alcohol and a clean cloth.
- Only use the bulb in a sealed headlamp.
- If the bulb breaks in a closed room, the room must be cleared of people and aired for at least 20 minutes to avoid health hazards due to the gases.
- Dispose of faulty bulbs as special waste.

20.7 Additional installation of electrical and electronic equipment

Safety recommendations for subsequent fitting of electrical and electronic equipment and/or components.

The tractor is equipped with electronic components whose functions can be influenced by electromagnetic signals from other units. This may constitute a danger - follow the safety instructions below, to avoid injuries.

When installing additional electrical and electronic equipment and/or components in the machine, and connecting them to the on-board electrical system, it is the user's responsibility to check for possible interference with the tractor electronic system. This is particularly important for:

Connection of consumers.

- Never connect any equipment to sensing components (sensors) since this may interfere with control functions (EPC, comfort control, etc.).

Power used by consumers.

- Voltage dips or spikes may lead to spurious error messages.

Short-wave transmitters.

- Transmissions without a special antenna can cause malfunctions (EPC, comfort control, etc.).

Make sure that all subsequently installed electrical and electronic components comply with the relevant version of EMC guideline 89/336/EEC, and that they carry the CE symbol.

Subsequent installation of mobile communication systems

For the subsequent installation of mobile communication systems (e.g. radio, telephone) the following requirements have to be met:

- Only equipment complying with national regulations may be installed.
- The equipment must be securely installed.
- Portable or mobile equipment used within the vehicle is permissible only when connected to an externally installed aerial.
- The transmitter must be fitted well clear of the vehicle electronics.
- Make sure the aerial is fitted properly with a good ground contact between aerial and vehicle body.

For cabling, installation and a maximum permissible power consumption, observe instructions of equipment manufacturer.

21. Fuses



DANGER:

Use only original fuses. Excess amperage fuses can destroy the electrical system. Fire hazard.

Fuse holder (X050, X051, F060-F067)

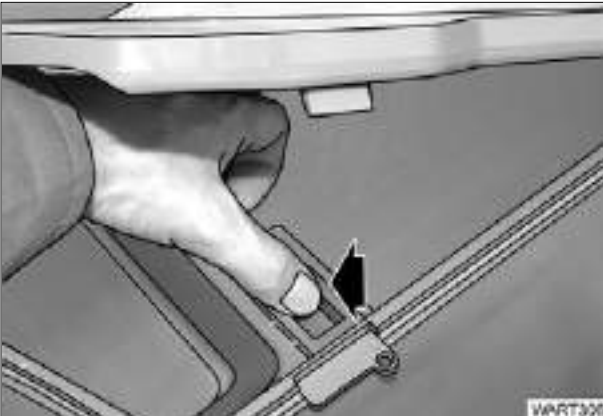

Fig.66

- Unlatch (arrow) and remove document box.



Fig.67

Fuse holder (X050, X051, F060-F067)

Fuse holder (A013)

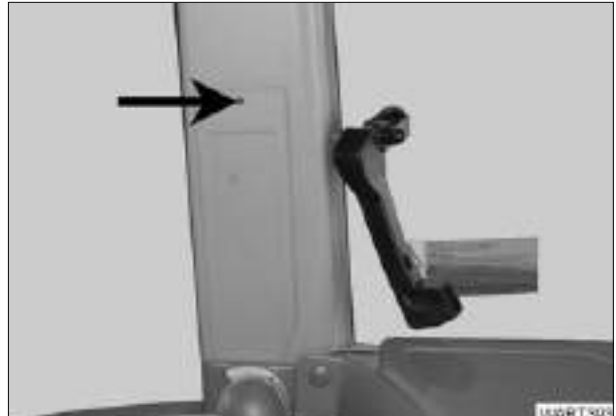

Fig.68

- Unscrew trim panel (arrowed).



Fig.69

Fuse holder (A013).

Starter relay fuse (A) 24 V

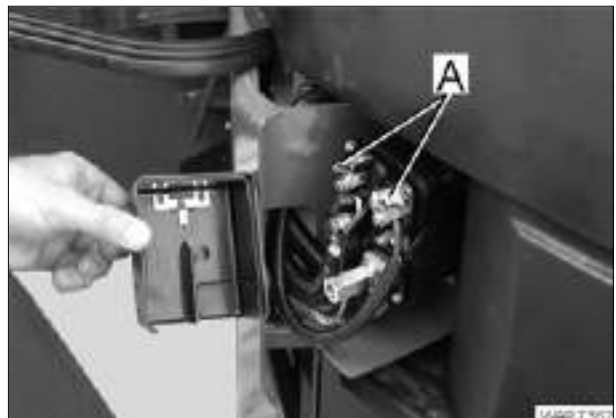

Fig.70

CARE AND MAINTENANCE

21.1 Fuse holder X050

Nr.:	1	2	3	4	5	6	7	8	9	10	11	12	13	14	15	16	17	18	19	20	21	22	23	24	25	26	27	28	29
PIN		30	30	30	30	30	30	30	30	30	30	30	15	15	15	15	15	15	15	15	15	15	15	15	15	15	15	50	15
Wert(A)		25	5	5	25	15	15	10	15	15	25	10	10	15	15	5	40	15	10	10	15	10	15	10	25	10	10	40	25
Verbraucher:																													
930.900.040.090																													

Fig.71

Fuse no.	PIN	Amps (A)	Consumers
1	-	-	-
2	30	25	Glow and starter switch in ON position
3	30	5	Joystick
4	30	5	Relay EPC Ub
5	30	25	LBS implement socket CAN bus connection
6	30	15	Hazard warning light pushbutton
7	30	15	Driving lamps pushbutton
8	30	10	Radio, cab interior lighting
9	30	15	Relay no. 56a (high beam)
10	30	15	Relay no. 56b (low beam)
11	30	25	Socket 25 A
12	30	10	10 A socket
13	15	10	Flame starting system
14	15	15	Heater switch
15	15	15	Hazard warning light pushbutton
16	15	5	Driving lamps pushbutton
17	15	40	Blower switch
18	15	15	Front screen wipers controller
19	15	10	Starter lockout switch, emergency operation relay
20	15	10	Steering column switch (combination switch)
21	15	15	Driver seat, heated seat
22	15	10	Engine brake
23	15	15	Brake relay
24	15	10	Hydraulic circuit 3
25	15	25	Rear window heater, mirror heater
26	15	10	Socket 10 A, reverse travel warning beep
27	15	10	LBS implement socket
28	50	40	Flame starting device in Start position
29	15	25	Not allocated

21.2 Fuse holder X051

Nr.	31	32	33	34	35	36	37	38	39	40	41	42	43	44	45	46	47	48	49	50	51	52	53	54	55	56	57	58	59		
PIN	58	58	58	58	58	58	58	58	30E	30E	30E	30E	30E	15E	15E	15E	15E	15E	15E	15	15	54	R	15E	58L	L	58R	30			
Wert(A)	25	5	25	40	25	25	5	5	10	5	40	10	15	5	5	5	5	15	5	5	5	10	10	5	10	10	10	40			
Verbraucher	Backlamp LBS	AC07 Kombi							AC08 AC07 Kombi	AC02 Kombi	AC04 Kombi	AC09 Kombi	AC04 Kombi	AC02 Kombi	AC08 Kombi	AC04 Kombi	AC07 Kombi	AC07 Kombi	AC07 Kombi	AC07 Kombi	AC07 Kombi	AC07 Kombi	AC07 Kombi	AC07 Kombi	AC07 Kombi	AC07 Kombi	AC07 Kombi	AC07 Kombi	AC07 Kombi	AC07 Kombi	AC07 Kombi

Fig.72

Fuse no.	PIN	Amps (A)	Consumers
31	58	25	Rear socket 20 amps
32	58	5	Instrument panel
33	58	25	Front work lamps switch
34	58	40	Front work lamps switch
35	58	25	Rear work lamps switch
36	58	25	Rear work lamps switch
37	58	5	Rear right tail light, right marker light
38	58	5	Rear left tail light, left marker light
39	30E	10	Terminal, communications box power supply
40	30E	5	Instrument panel
41	30E	40	E-box comfort
42	30E	10	Operating console
43	30E	15	Actuator control
44	15 E	5	Operating console
45	15 E	5	E-box comfort
46	15 E	5	Vario Terminal
47	15 E	5	Joystick
48	15 E	15	EHR, OBE
49	15 E	5	Instrument panel
50	15/58	15	Valve heating
51	15/58	5	Implement socket, communications box power supply
52	54	10	Trailer socket
53	R	10	Front socket for front power lift, trailer socket
54	15 E	5	Test connection
55	58L	10	Front socket for front power lift, trailer socket
56	L	10	Front socket for front power lift, trailer socket
57	58R	10	Trailer socket
58	30	15	Engine control
59	-	-	-

CARE AND MAINTENANCE

21.3 Fuse holder F060 - F067

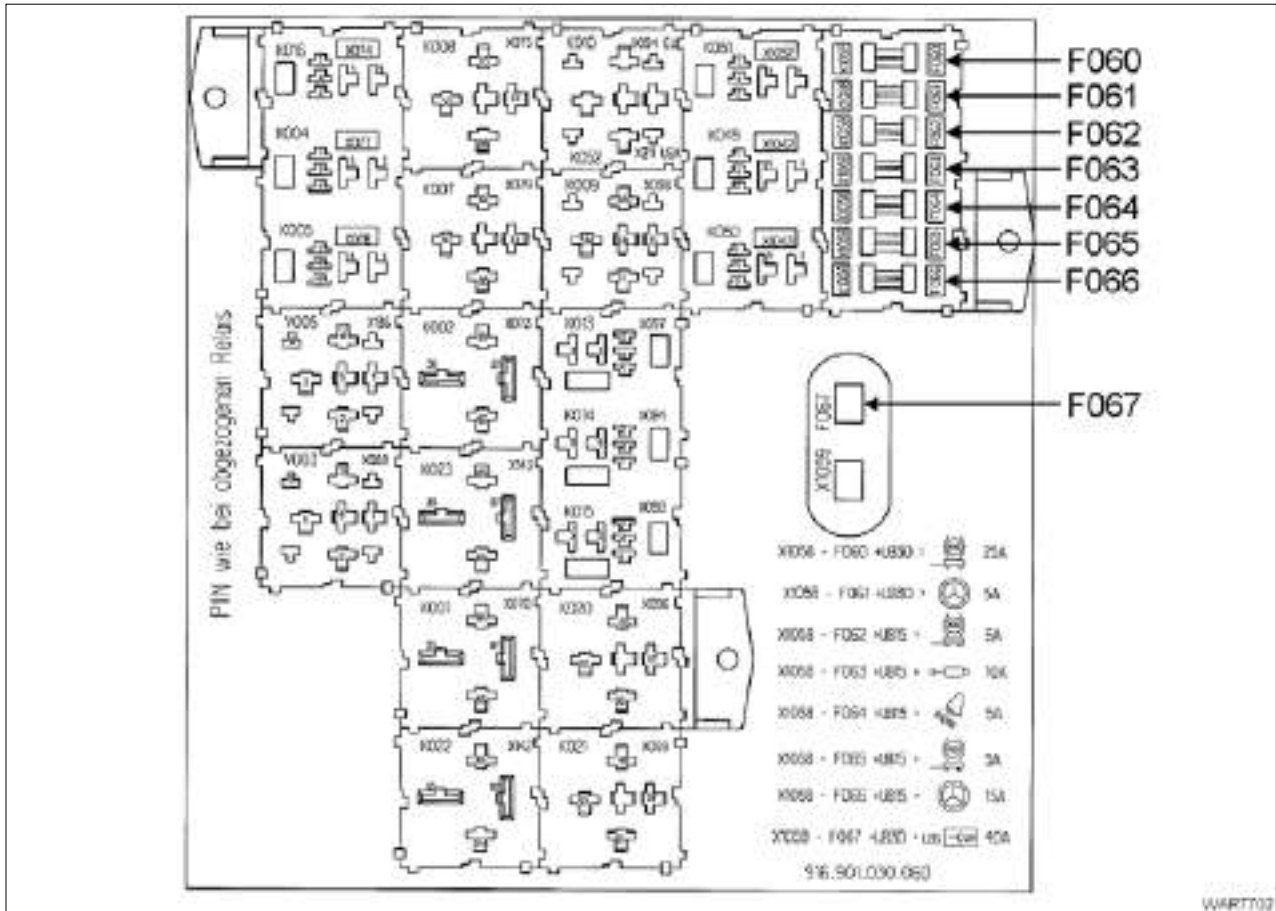

Fig.73

Fuse no.	Clip	Amps (A)	Consumers
F060	30	25	Socket ABS PIN 1, UB30
F061	15	5	Socket ABS PIN 1, UB15
F062	15	5	Indicator lamp ABS
F063	15	10	Power supply spool valves (SB23)
F064	15	5	Radar sensor
F065	30	15	Joystick
F066	-	-	-
F067	30	60	LBS-socket pin3, DIN-ISO

21.4 Fuse holder (A013)

Zeichn. Nr.	Terminale	Komponente	Termin. Komp.
01	X200/18		
02	X200/16	2. Hochdrucksensor	X177
03	X200/15	Hochdrucksensor	X157
04	X200/14	Halgeber Motor1	X159
05	X200/10		
06	X200/11		
07	X200/12	Drehwinkelsensor Kegeltrieb	X164
08	X200/09	Drehwinkelsensor Kegeltrieb	X166
09	X201/14		
10	X201/12		
11	X201/11	Drehwinkelsensor Lage Frontkraftheber	X188
12	X201/10		
13	X200/07	Drehwinkelsensor Fahrbereichsan.	X165
14	X200/08		
15	X200/04		
16	X200/05	Drehgeber Hydrotrol Sum.welle	X163
17	X200/06	Drehwinkelsensor Fußpedal	X176
18	X201/04	Drehwinkelsensor Federweg	X152
19	X201/05		
20	X201/06		
21	X201/07	Lenkwinkelsensor	X403 X404
22	X201/08	Halgeber Zapfw. v.	X151
23	X201/09		
24	X201/18	Motor Rückgeber	X161
25	X201/16	Druckluftgeber	X168
26	X201/15	Drehwinkelsensor Handgas	X183
27	X202/07		
28	X202/06		
29	X202/05		
30	X202/04		
31	X202/08		
32	X202/09	Halgeber Zapfw. h.	X169
33	X202/10	Halgeber Zapfw. h. n. Kegel	X170

718.901.040.201

Fig.74

Fuse	Con- nector	Components	Comp. sep. pt.
01	X200/18	-	-
02	X200/16	2nd high-pressure sensor	X177
03	X200/15	High pressure sensor	X157
04	X200/14	Engine Hall sensor 1	X159
05	X200/10	-	-
06	X200/11	-	-
07	X200/12	Bevel pinion turning angle sensor	X164
08	X200/09	Clutch pedal turning angle sensor	X166
09	X201/14	-	-
10	X201/12	-	-
11	X201/11	Front power lift position turning angle sensor	X188
12	X201/10	-	-
13	X200/07	Operating range recognition torque sensor	X165
14	X200/08	-	-
15	X200/04	-	-
16	X200/05	Speed sensor, hydrostatic drive collector shaft	X163
17	X200/06	Accelerator pedal turning angle sensor	X176
18	X201/04	Suspension turning angle sensor	X152
19	X201/05	-	-
20	X201/06	-	-
21	X201/07	Steering angle sensor	X403
22	X201/08	Front PTO Hall generator	X151
23	X201/09	-	-
24	X201/18	Engine oil pressure sensor	X161
25	X201/16	Compressed air sensor	X168
26	X201/15	Hand throttle turning angle sensor	X183
27	X202/07	-	-
28	X202/06	-	-
29	X202/05	-	-
30	X202/04	-	-
31	X202/08	-	-
32	X202/09	Rear PTO Hall generator	X169
33	X202/10	Rear PTO Hall generator	X170

22. Wiring diagrams

22.1 Legend for circuit diagrams

X001 to X999 are electric couplers, butt-type connectors and other connectors.

A002	= E-Box	B029	= Accelerator pedal turning angle sensor
A003	= Drive mode switch	B030	= Measured value, position sensor
A004	= Operating console	B031	= Right load sensor pin
A005	= E-box lifting gear control	B032	= Load sensor pin left
A006	= Front dashboard keyboard	B033	= Discharge temperature sensor
A007	= Instrument panel	B034	= Immersed tube sensor
A008	= Vario Terminal	B035	= Hand throttle turning angle sensor
A009	= Actuator control	B036	= Tank sensor 1
A010	= Electronic thermostat	B037	= Tank Sensor 2
A011	= Radar sensor	B038	= EDC accelerator angle sensor
A012	= Flame starting system	B040	= Front power lift position torque sensor
A013	= Fuse board ABC	B041	= Temperature sensor (Air cond. NT C2)
A015	= Radio pre-fitting	B046	= Temperature sensor (Air cond. NT C1)
A016	= Mirror heater	B047	= Steering angle switch
A017	= LBS bus termination board	B050	= Loudspeaker, left
A018	= Tank	B051	= Loudspeaker, right
A020	= Electronic injection pump	E001	= H4 headlamp, right
A021	= EDC electronics box	E002	= H4 headlamp, left
A023	= Front LBS bus terminal	E003	= H4 headlamp, right
B001	= Steering angle sensor 1	E004	= H4 additional work lamp, left
B002	= PTO speed Hall sensor	E005	= Position lamp, front right
B003	= Suspension turning angle sensor	E006	= Position lamp, front left
B004	= Vacuum switch	E007	= Turn signal/brake/tail lamp, right
B005	= Engine temperature sensor	E008	= Left turn signal/brake/taillamp
B006	= Charge air temperature sensor	E009	= Licence plate lamp, right
B007	= Fuel level sensor	E010	= Licence plate lamp, left
B008	= High pressure sensor	E011	= Work lamp on roof, right rear
B009	= Discharge temperature sensor	E012	= Left rear roof work lamp
B010	= Engine Hall sensor 1	E013	= Right front roof work lamp
B012	= Engine oil pressure sensor	E014	= Work lamp on roof front left
B013	= Hydraulic oil temperature switch	E015	= Front work lamp on right turn signal lamp
B014	= Speed sensor, hydrostatic drive collector shaft	E016	= Front work lamp at left turn signal lamp
B015	= Bevel pinion speed sensor	E017	= Work lamp on taillamp holder right
B016	= Operating range recognition torque sensor	E018	= Work lamp at left taillamp holder
B017	= Clutch pedal turning angle sensor	E019	= Cab lighting
B018	= Engine rpm setpoint sensor	E020	= EPC lighting
B019	= Compressed air supply pressure sensor	E021	= Rotating beacon, right
B020	= Rear PTO rpm Hall sensor	E022	= Rotating beacon left
B021	= Rear PTO rpm after clutch sensor	E023	= Rear window heater
B022	= Kickout pressure switch	E024	= Right mirror heater connection
B023	= Flame starting system temperature sensor	E025	= Connection, mirror heater left
B024	= Steering angle sensor 2	E026	= Right turn signal lamp, on roof top rear
B025	= EDC speed sensor	E027	= Left turn signal indicator, roof top rear
B026	= EDC needle motion sensor		
B027	= Water temperature sensor		
B028	= ICharge pressure sensor		

CARE AND MAINTENANCE

E030	= Right-hand side working lamp	S011	= Rotating beacon switch
E031	= Left-hand side working lamp	S012	= Starter lockout switch
E032	= Diagnosis lamp	S013	= Emergency mode button
E033	= Fuel heating	S014	= Quick reverse button at steering wheel adjustment
E034	= Left licence plate lighting in tail light	S015	= Hand brake switch
G001	= Battery 1	S016	= EPC/DA switch
G002	= Alternator 1	S017	= Filter contamination switch
G003	= Battery 2	S018	= Engine brake pressure switch
G004	= Alternator 2	S019	= PTO ON key, rear left
H005	= Horn	S020	= Key PTO ON, rear right
H006	= Buzzer	S021	= External control button, raise front power lift
H010	= Indicator lamp for generator 2	S022	= External control button, lower front power lift
K001	= Relay +Ub 15	S023	= Lock solenoid switch, external front power lift control button
K002	= Relay +Ub 58	S024	= Brake fluid display
K003	= Relay +Ub 15E	S025	= Steering pressure switch
K004	= Relay 56A	S026	= Flow controller
K005	= Relay 56B	S027	= External Raise button, right
K006	= Cold-start indicator lamp relay	S028	= External Lower button, right
K007	= Brake relay	S029	= External button lift, left
K008	= Starter lockout relay	S030	= External "Lower" button left
K009	= Screen wipers pulse generator	S031	= Right door contact switch
K010	= Turn flasher relay	S032	= Door contact switch, left
K011	= Relay EPC Ub	S033	= Heater switch
K013	= 3rd hydraulic circuit relay	S034	= Coolant level switch
K014	= Engine brake relay	S035	= Air conditioning high/low pressure switch
K015	= Emergency operation relay	S036	= Level switch, hydraulic oil level
K016	= Suspension valve relay	S037	= Blower switch
K017	= Current spike relay, EPC/DA changeover	S038	= Rear screen heater switch
K018	= Battery changeover relay	S039	= Mirror heater toggle switch
K020	= EDC UB 30 relay	S041	= Front PTO brake
K021	= Cutout solenoid relay	S044	= Air conditioning switch
K022	= Relay +Ub 15	S045	= Rūfa solenoid switch
K023	= Relay +Ub 58	S047	= Engine brake tappet switch
K029	= EPC - DA changeover relay	S048	= EPC - DA changeover solenoid switch
K033	= Fuel preheating relay	S051	= Fuel preheater temperature switch
M001	= Starter	V003	= Diode group
M002	= Front wiper motor separation point	V005	= Diode group
M003	= Front windshield washer system pump	Y001	= Excess quantity solenoid valve
M004	= Rear window wiper motor	Y002	= Driving mode 1 solenoid valve
M005	= Screen washers pump, rear	Y003	= Solenoid valve operating range 2
M007	= Engine electric coupler seat adjustment	Y004	= Transmission solenoid neutral/turbo-clutch valve
M008	= Heater fan line coupler	Y005	= Solenoid valve speed limiter
M009	= Fan speeds 1 - 3	Y006	= Engine brake solenoid valve
M011	= Starter 24V	Y007	= Engine Off solenoid
R001	= Glow plug	Y008	= Rear PTO solenoid
S001	= Steering column switch	Y009	= 4-WD solenoid
S002	= Ignition-starter switch	Y010	= Diff. lock solenoid
S003	= Driving lamps pushbutton	Y011	= Front PTO solenoid
S004	= Hazard warning light pushbutton	Y012	= Load suspension solenoid
S005	= Right brake solenoid switch	Y013	= Lower suspension solenoid
S006	= Left brake solenoid switch	Y014	= Raise suspension solenoid
S007	= Additional lighting pushbutton		
S008	= Front work lamps switch		
S009	= Rear work lamps switch		
S010	= Rear wiper motor switch		

CARE AND MAINTENANCE

Y015	= Valve 1
Y016	= Valve 2
Y017	= Valve 3
Y018	= Valve 4
Y019	= Valve 5
Y021	= Raise solenoid
Y022	= Lower solenoid valve
Y023	= Compressed air pilot control solenoid valve
Y024	= Air conditioning magnetic clutch
Y025	= Flame starting system solenoid valve
Y026	= Rear PTO stage 1 solenoid
Y027	= Solenoid valve, rear PTO stage 2
Y028	= Solenoid valve, rear PTO stage 3
Y030	= EPC/DA lock solenoid valve
Y031	= EPC/DA pilot control solenoid valve
Y032	= Solenoid valve neutral (valves)
Y033	= Solenoid valve, flush valves
Y034	= Brake release solenoid valve

22.2 Colour coding for electric wires

Colour of wire	Abbreviation	Mark
white (with black printing)	ws	General colour of wires
red	rt	+ UB 30
black	sw	+ UB 15
yellow	ge	+ UB 15E
grey (basic colour for lighting)	gr	+ UB 58
grey - black	gr-sw	+ UB 58 lighting left
grey - red	gr-rt	+ UB 58 lighting right
yellow	ge	+ UB power supply
brown	br	vehicle body ground
brown - white	br-ws	Electronics ground
brown - yellow	br-ge	Sensors ground
black - green	sw-gn	Right side turn signal lamp
black - white	sw-ws	Left side turn signal lamp
orange	or	Additional wiring
blue	bl	
pink	rs	
turquoise	tk	
violet	vi	

22.3 Wiring diagrams

List of wiring diagrams

- Sheet 2 = Power supply + UB
- Sheet 3 = Grounding layout
- Sheet 4 = Starter control
- Sheet 5 = Cold-start system
- Sheet 6 = Engine brake and engine switch-off, active stationary
- Sheet 7 = STVZO lighting Sheet 1
- Sheet 8 = STVZO lighting with horn Sheet 2
- Sheet 9 = Turn signal system
- Sheet 10 = Brake light, compressed air supply, hydr. trailer brake, ABS brake
- Sheet 11 = Wipers and rotating beacon
- Sheet 12 = Work lamps front, EPC lighting
- Sheet 13 = Rear work lamps
- Sheet 14 = Cab interior lighting and radio
- Sheet 15 = Ventilation and air conditioning
- Sheet 16 = Heater
- Sheet 17 = Heated rear window, electrical mirrors
- Sheet 18 = Socket and open separation points, seat switch
- Sheet 19 = Implement socket, socket event counter
- Sheet 20 = Electronics power supply
- Sheet 21 = Comfort bus (K bus)
- Sheet 22 = Instrument panel
- Sheet 23 = Electrohydraulic lifting gear control
- Sheet 24 = Electro-hydraulic spool valves 1 (+UB valves, hydraulics monitoring, external valve actuation)
- Sheet 25 = Hydraulic valve 2 (front power lift, hydr. circuit 3, valve operation)
- Sheet 26 = Transmission bus (G bus)
- Sheet 27 = Transmission control
- Sheet 28 = Transmission emergency operation
- Sheet 29 = Suspension
- Sheet 30 = PTO
- Sheet 31 = 4WD and differential lock
- Sheet 32 = LBS (Agricultural BUS system)
- Sheet 33 = Engine control

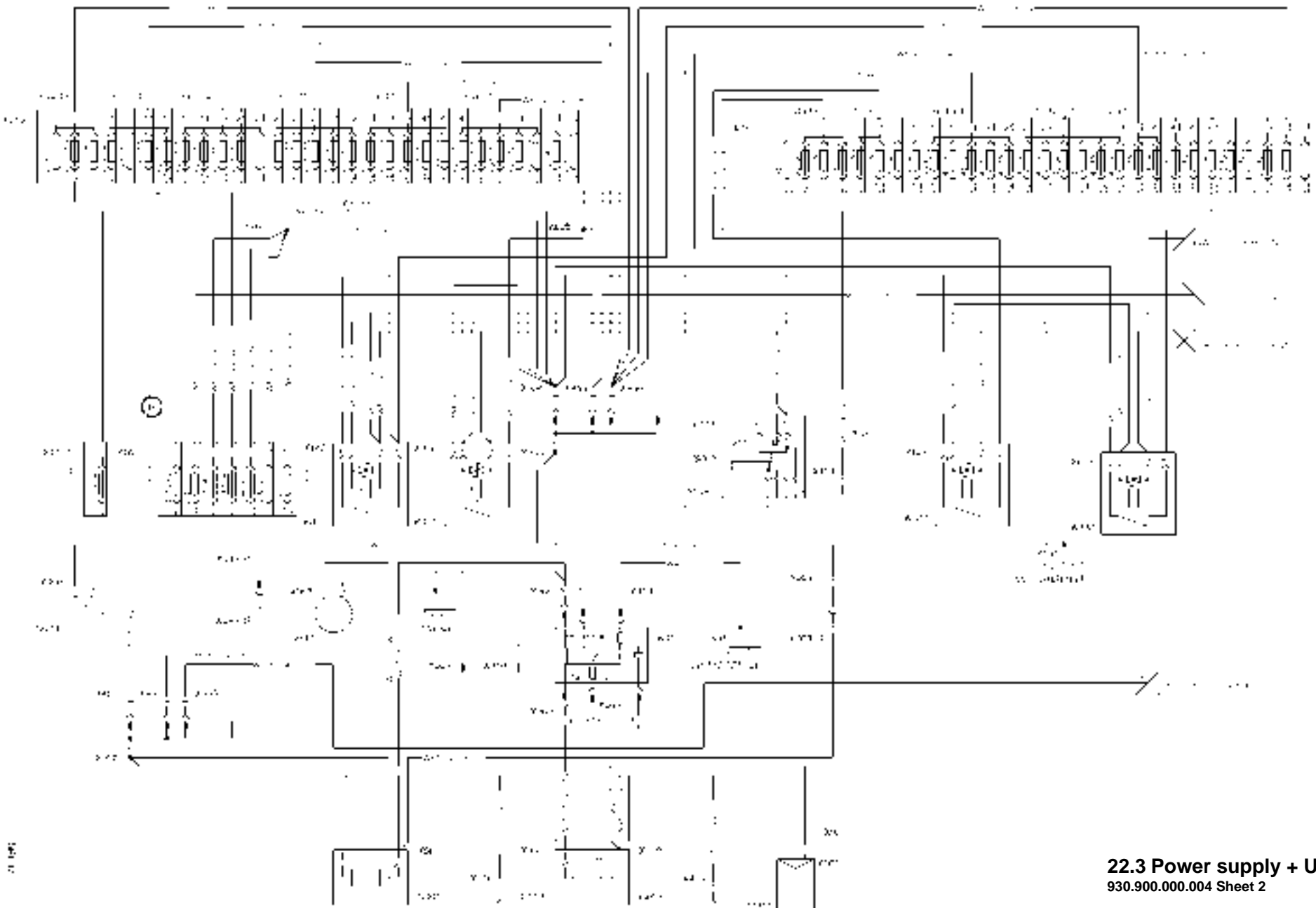

22.3 Power supply + UB
930.900.000.004 Sheet 2

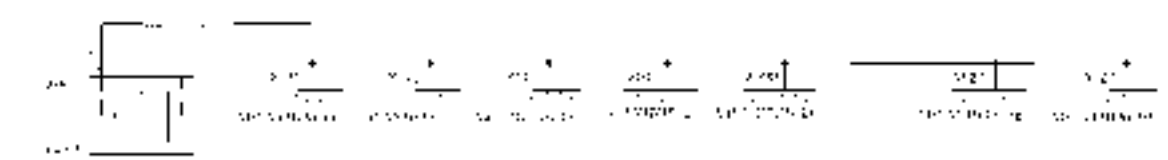
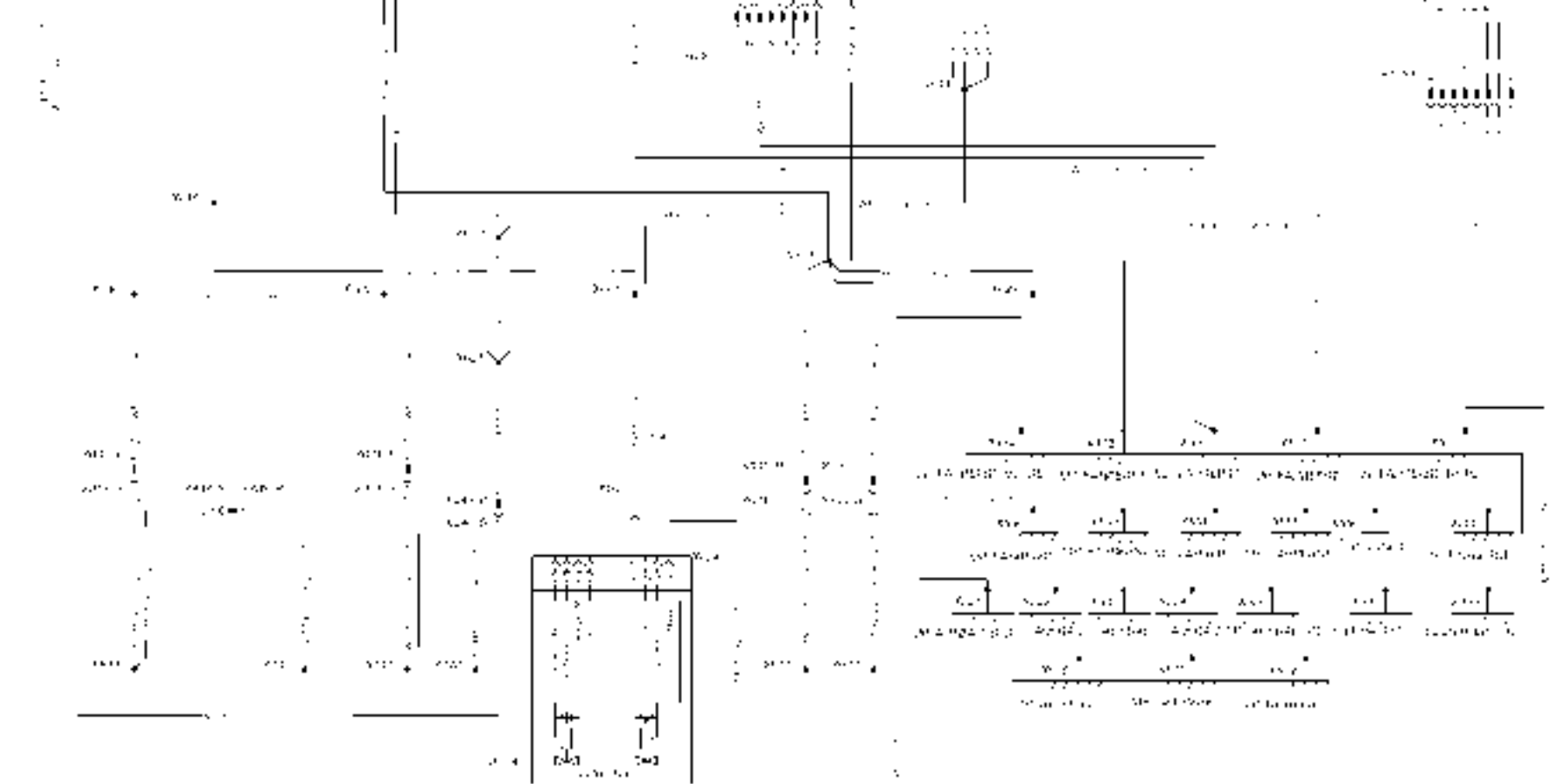
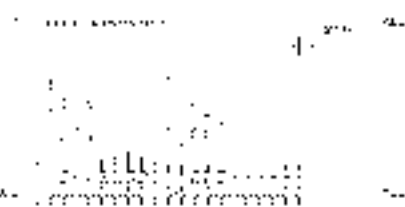

22.4 Grounding layout
930.900.000.004 Sheet 3

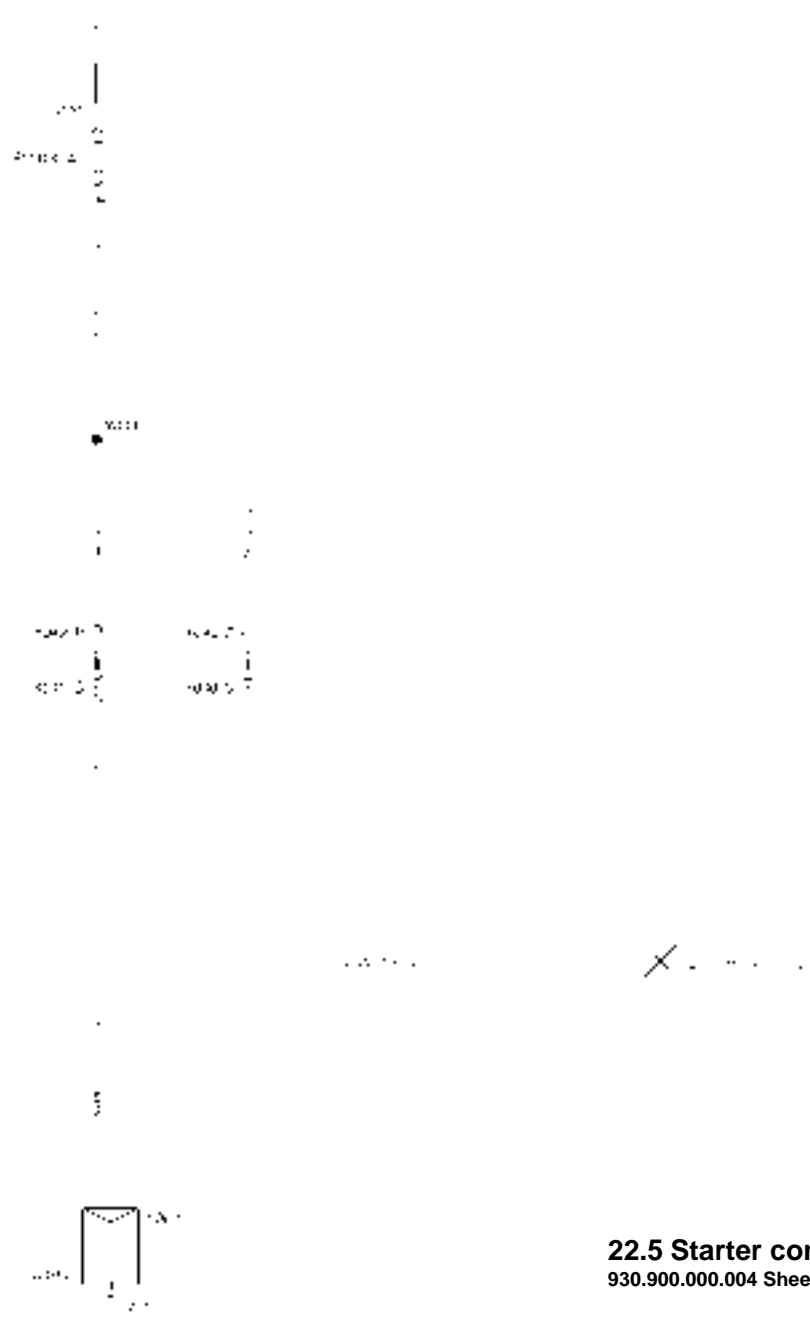

22.5 Starter control
930.900.000.004 Sheet 4

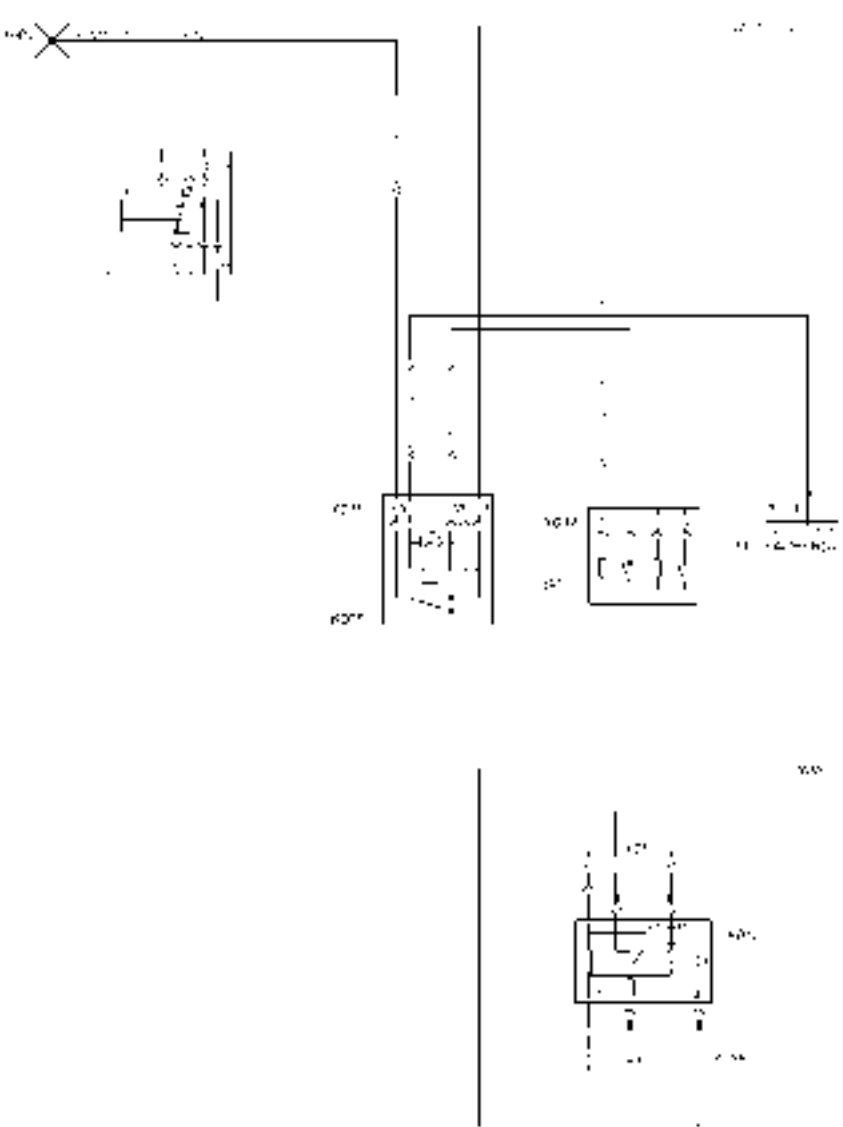

31524

22.6 Cold-start system
930.900.000.004 Sheet 5

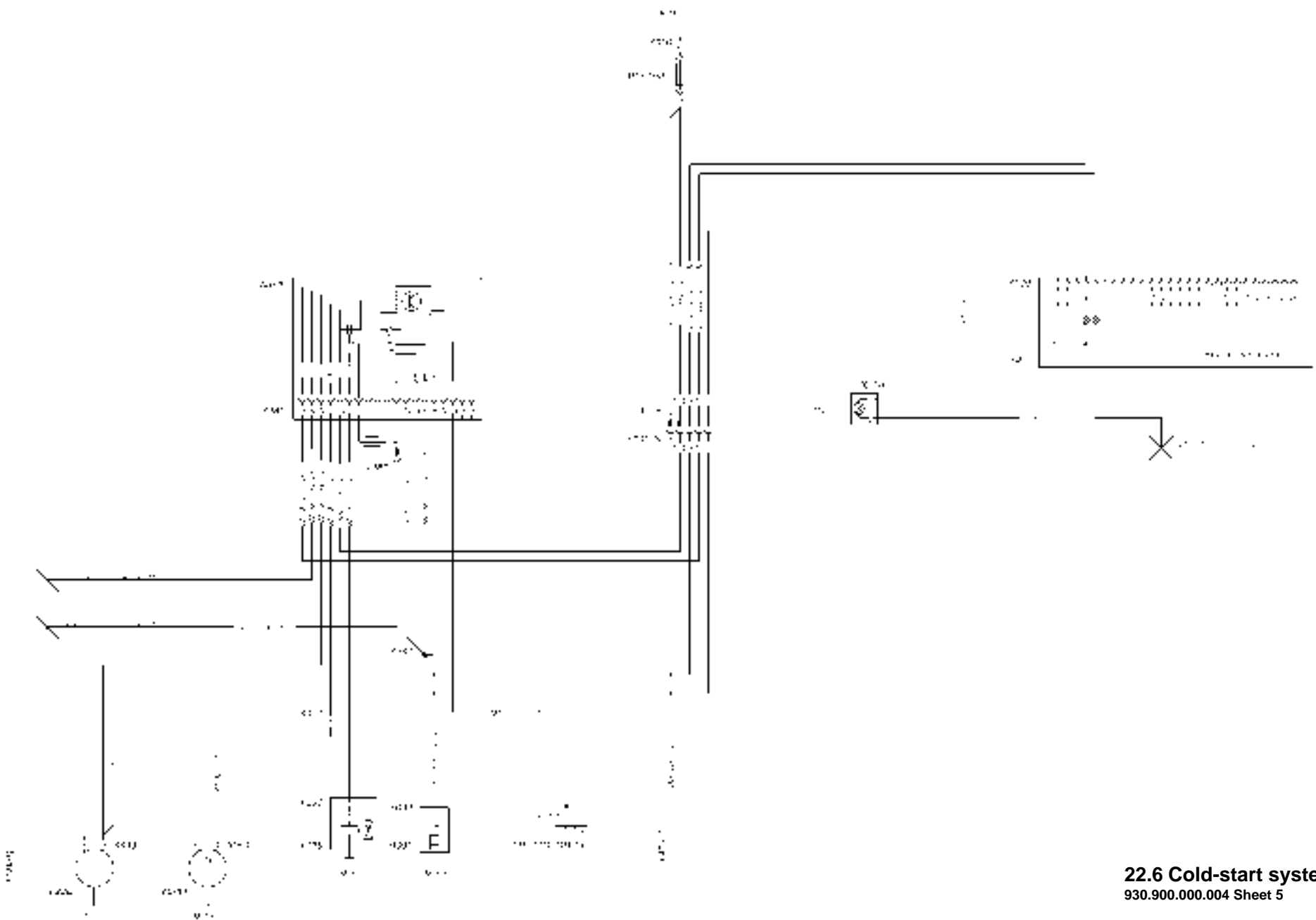

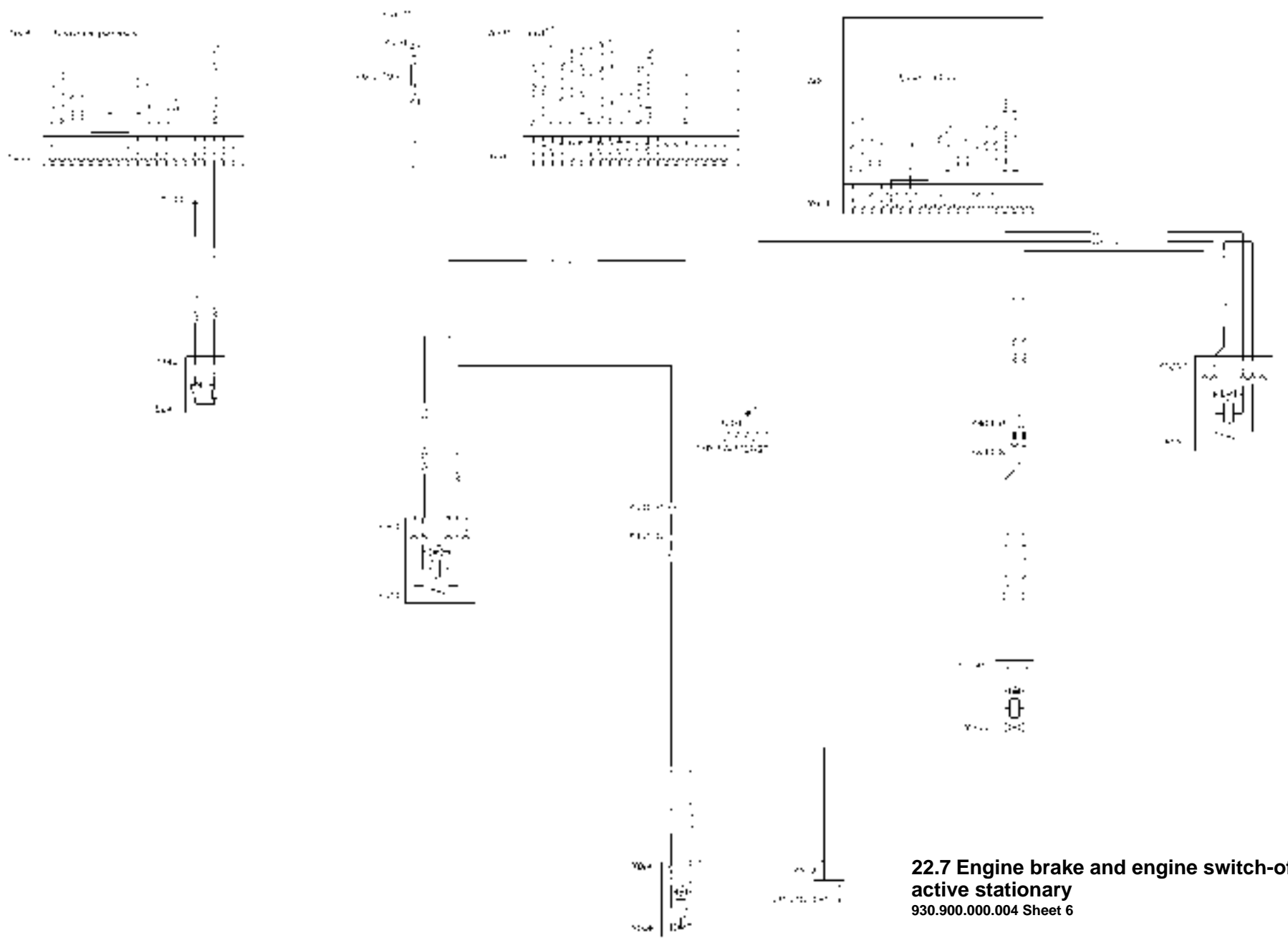

22.7 Engine brake and engine switch-off, active stationary
930.900.000.004 Sheet 6

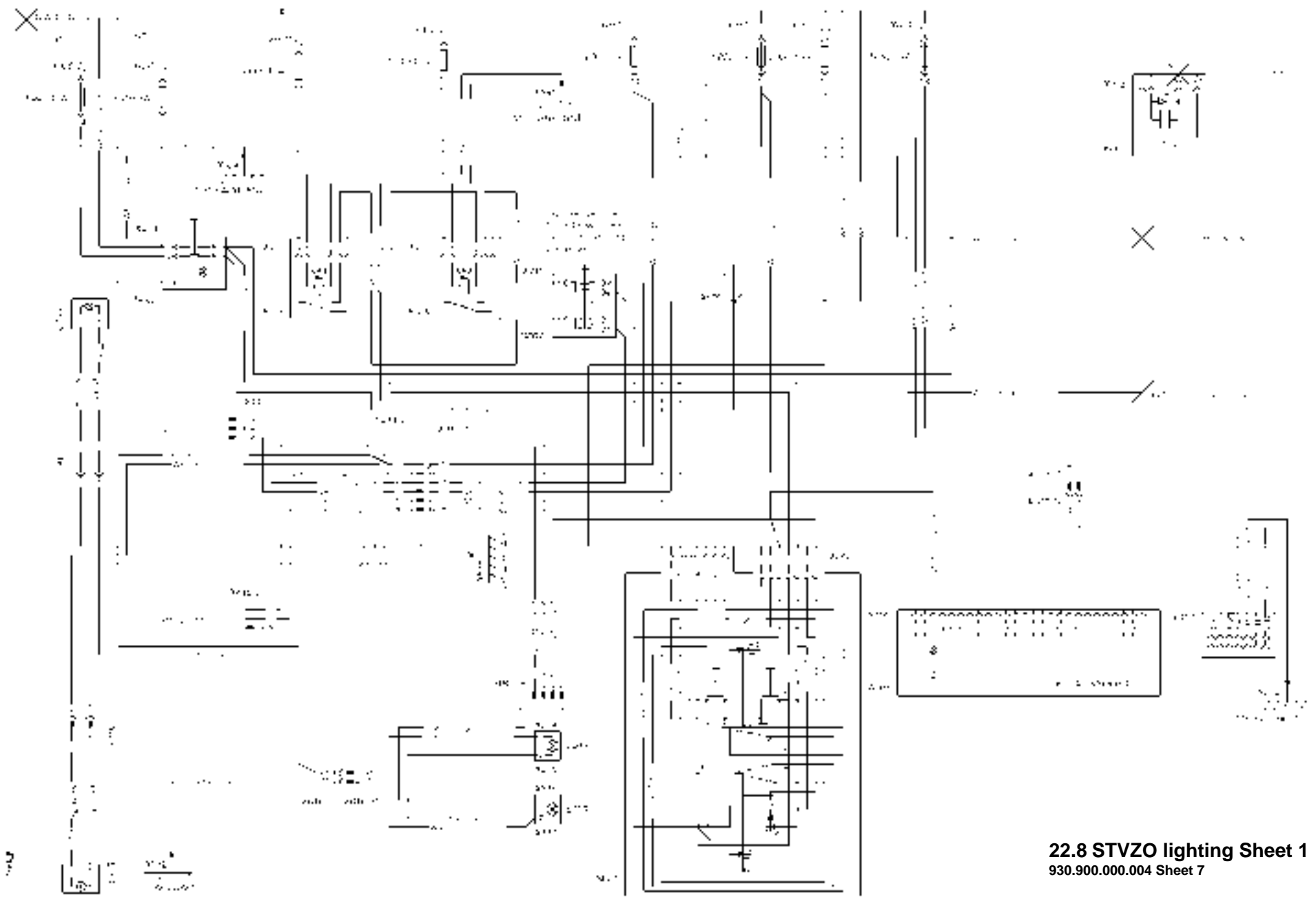

22.8 STVZO lighting Sheet 1
930.900.000.004 Sheet 7

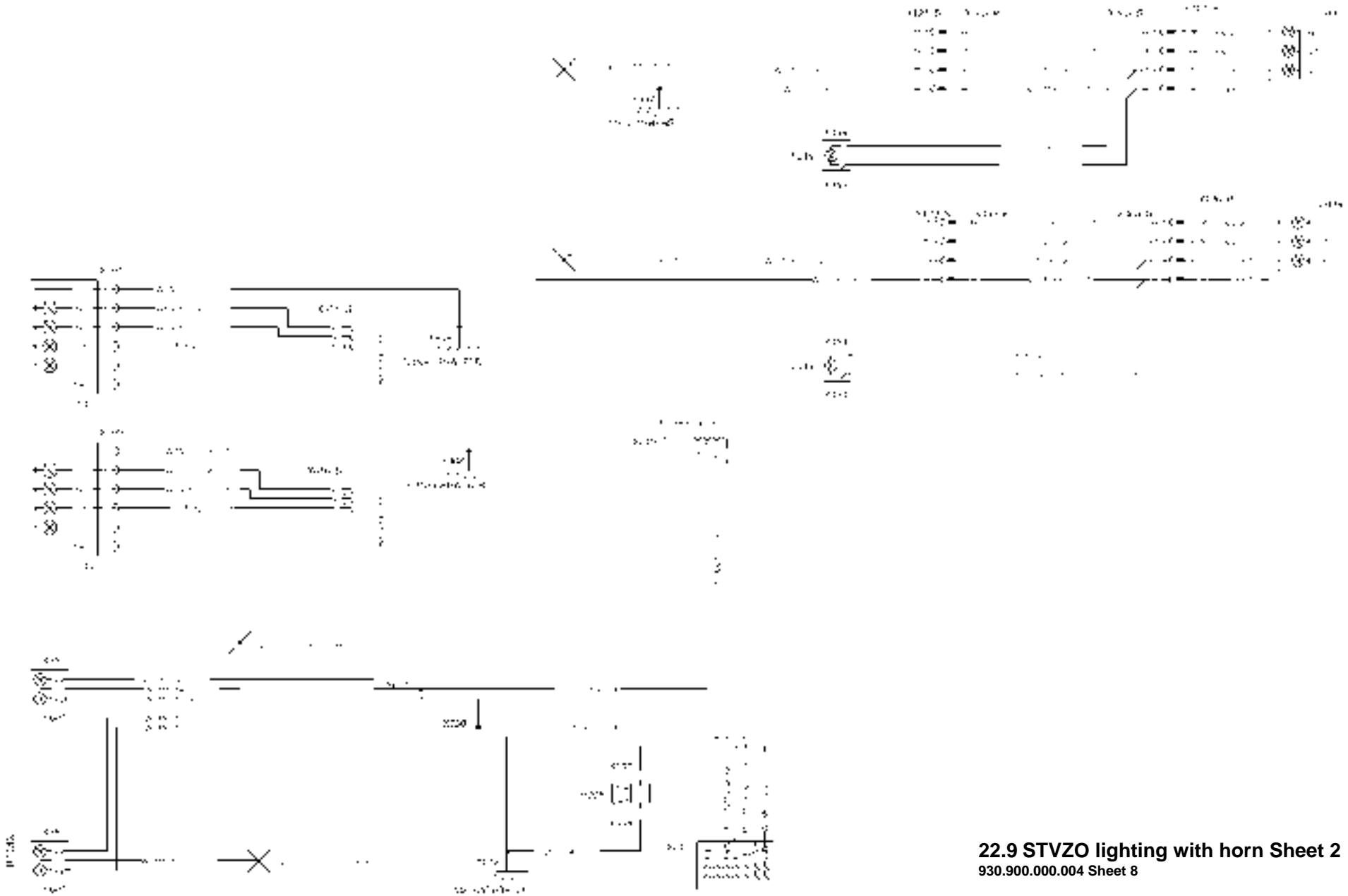

22.9 STVZO lighting with horn Sheet 2
930.900.000.004 Sheet 8

22.10 Turn signal system
930.900.000.004 Sheet 9

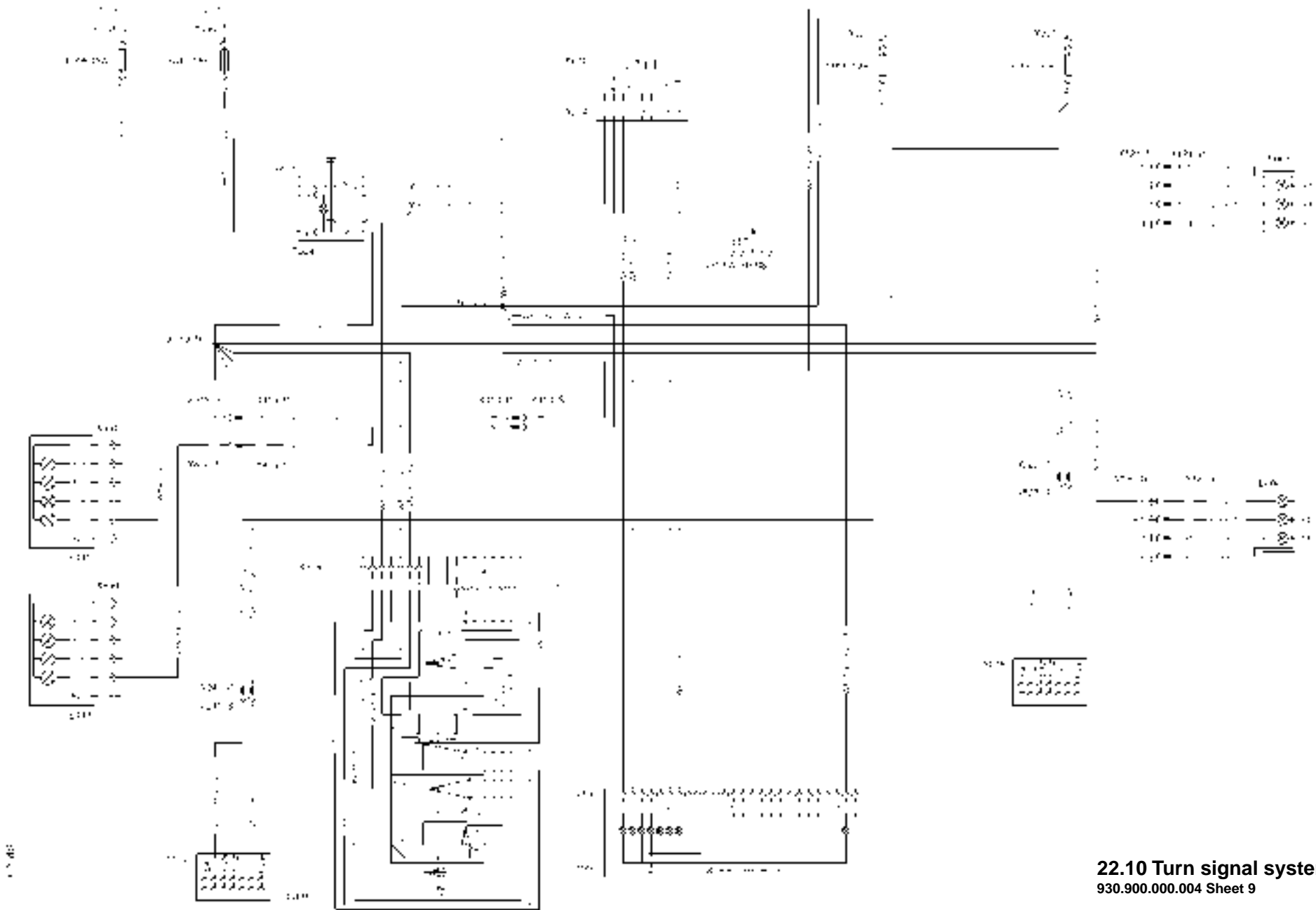



22.11 Brake light, compressed air supply, hydr. trailer brake, ABS brake
930.900.000.004 Sheet 10

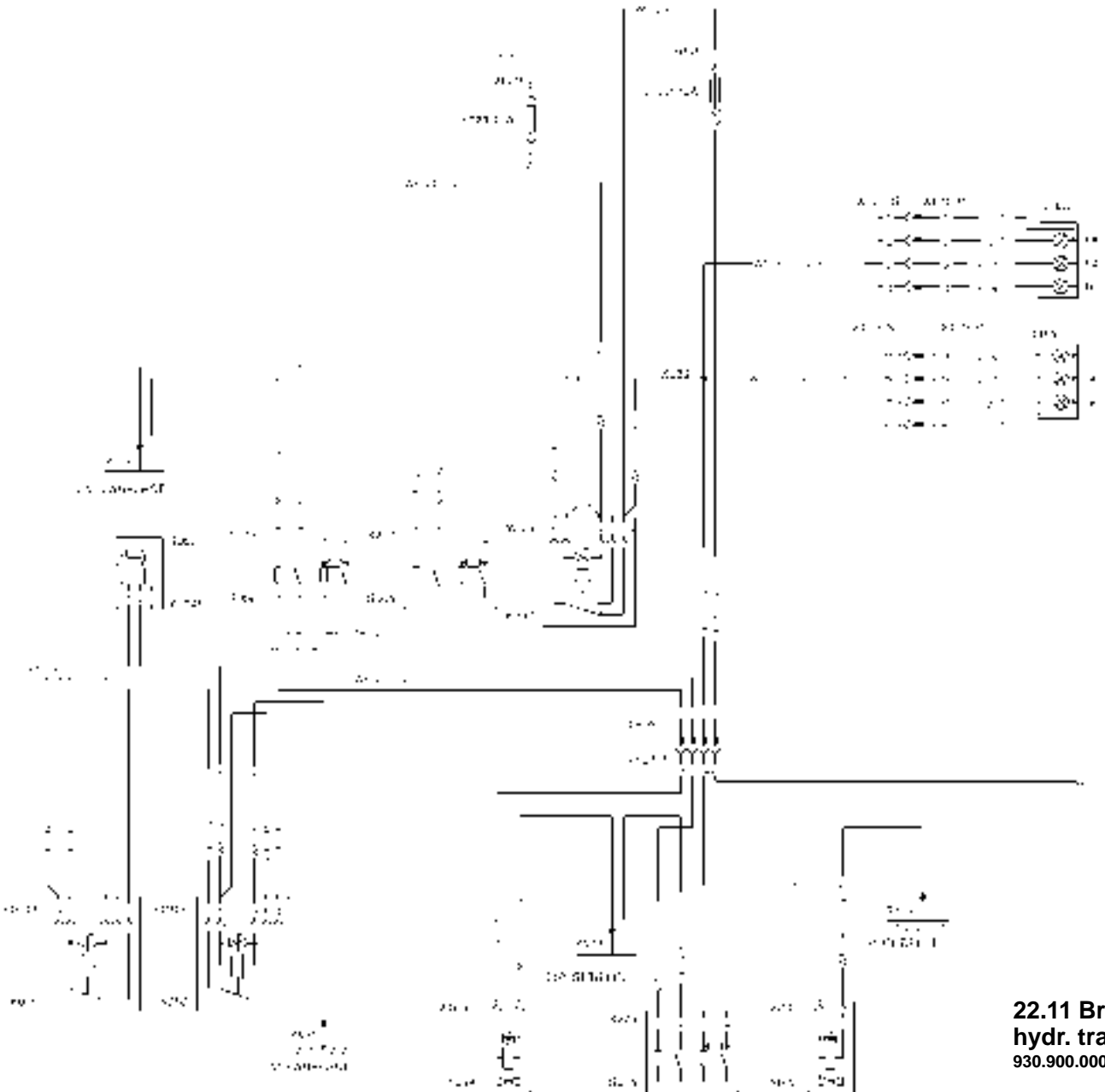

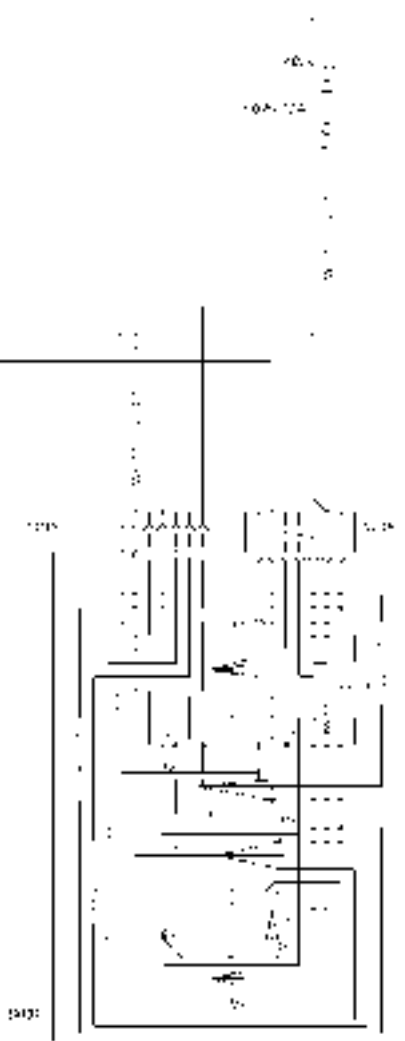

22.12 Wipers and rotating beacon
930.900.000.004 Sheet 11

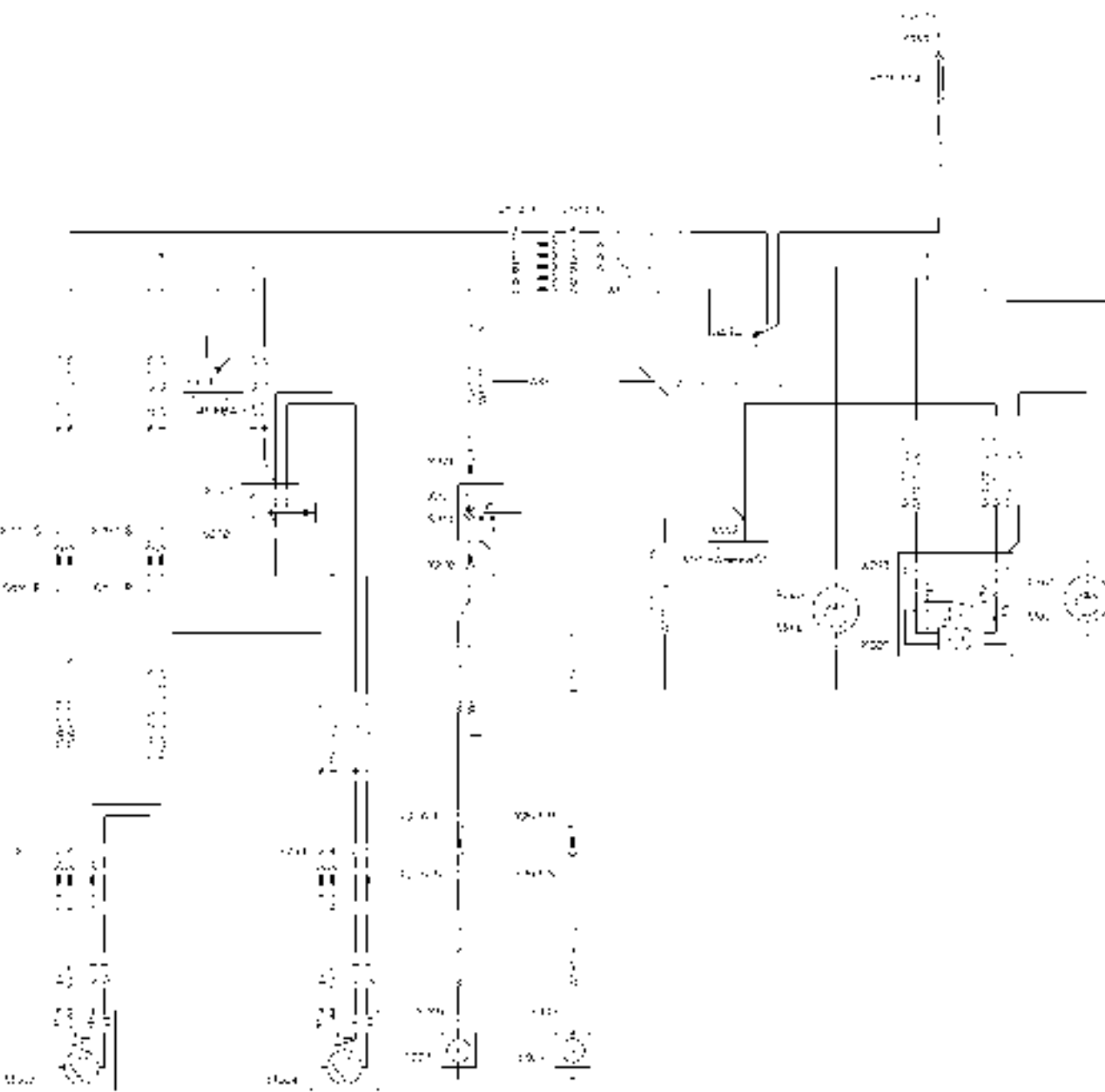

22.12

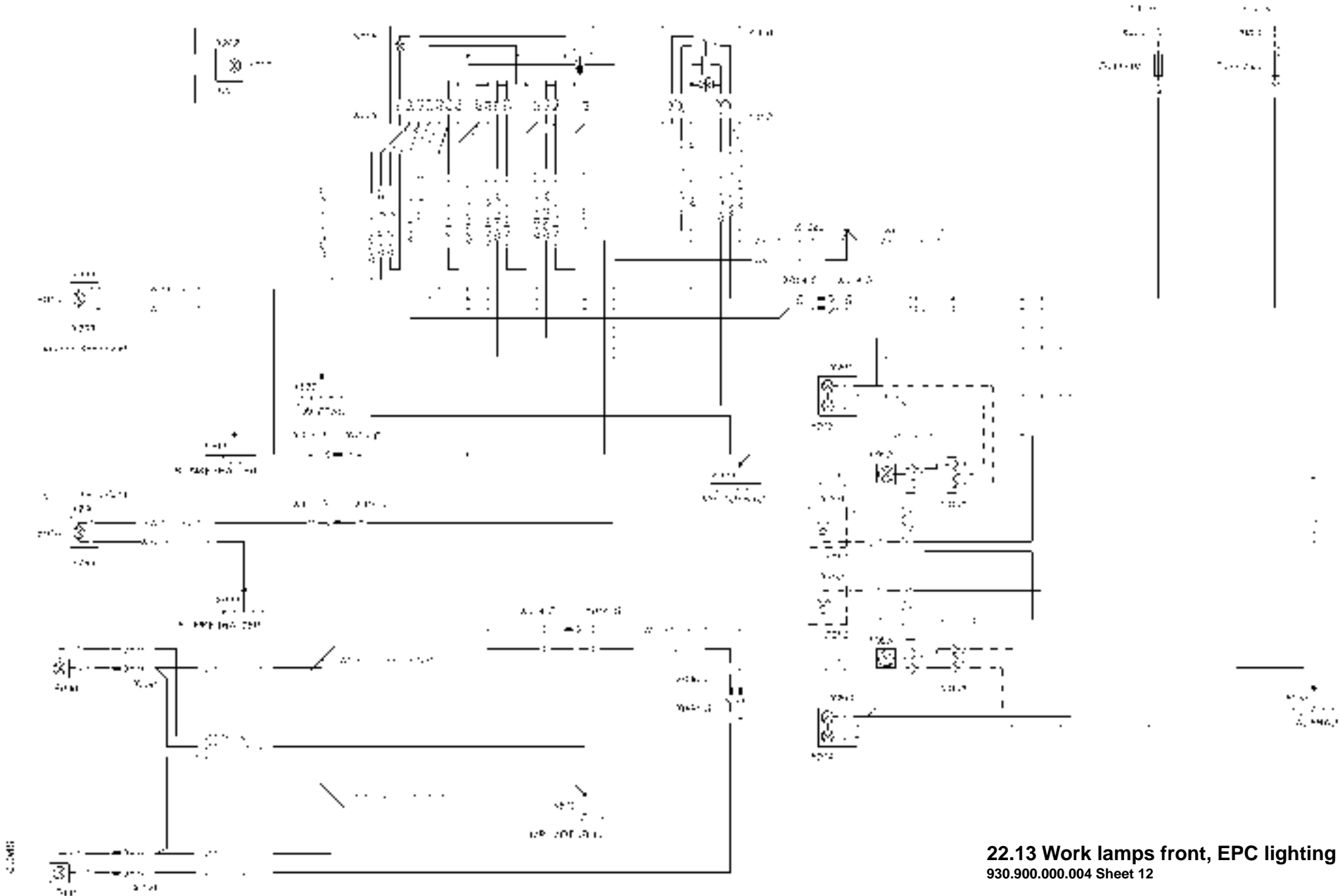

22.13 Work lamps front, EPC lighting
930.900.000.004 Sheet 12

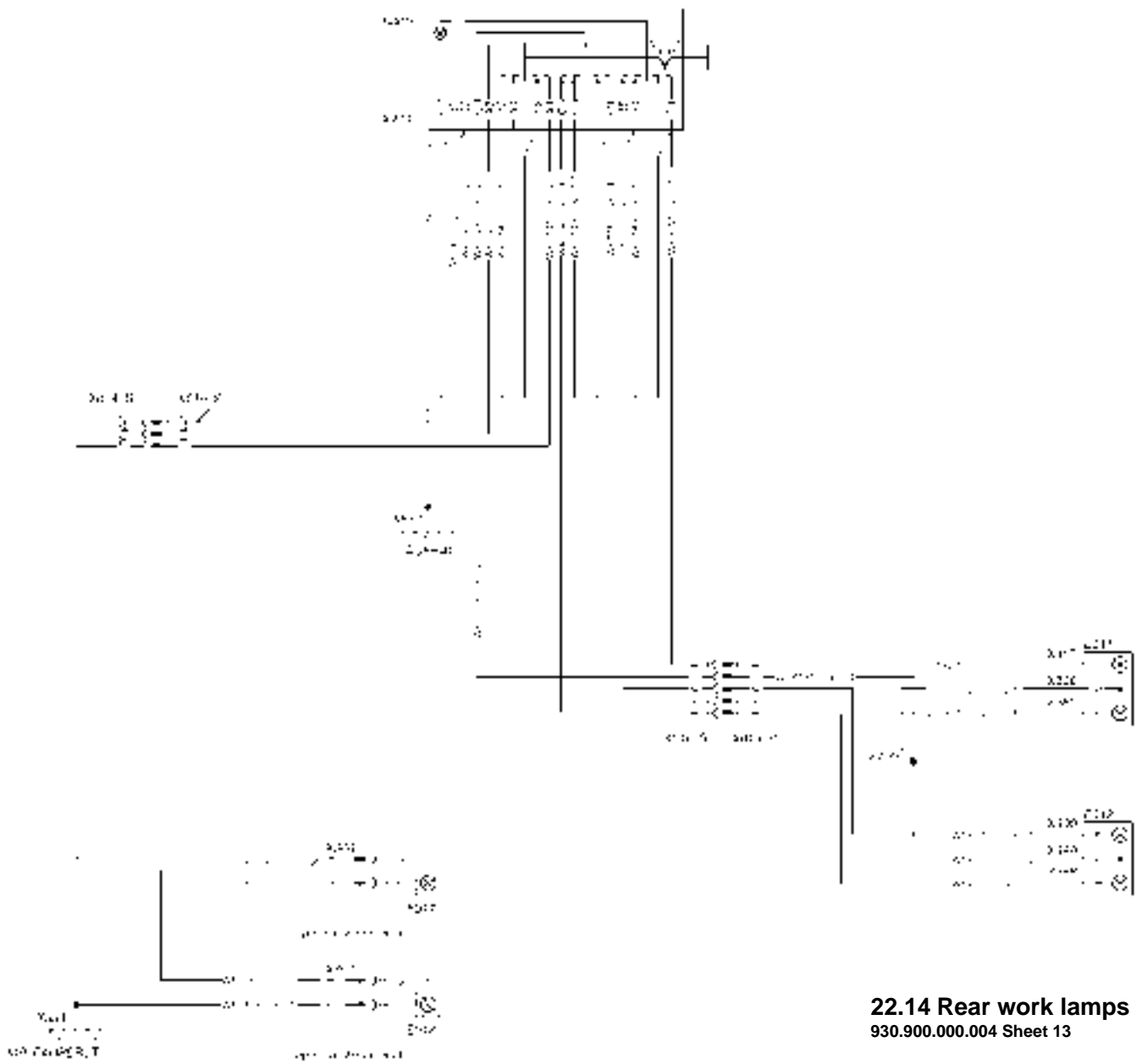

22.14 Rear work lamps
930.900.000.004 Sheet 13



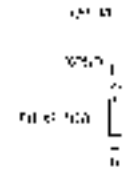

2014 B



2014 B

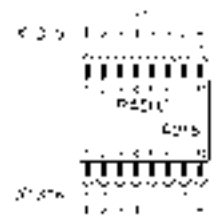
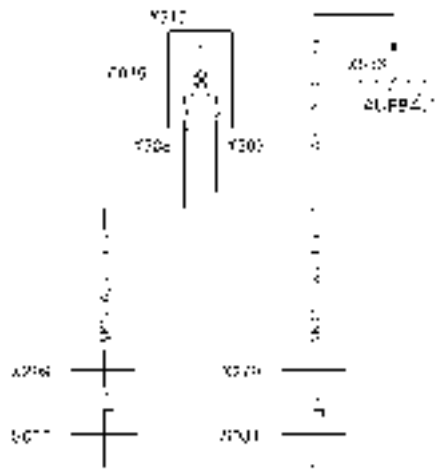

2014 B

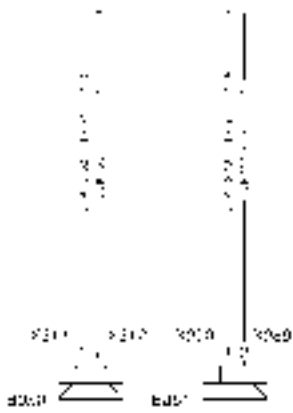

22.15 Cab interior lighting and radio
930.900.000.004 Sheet 14

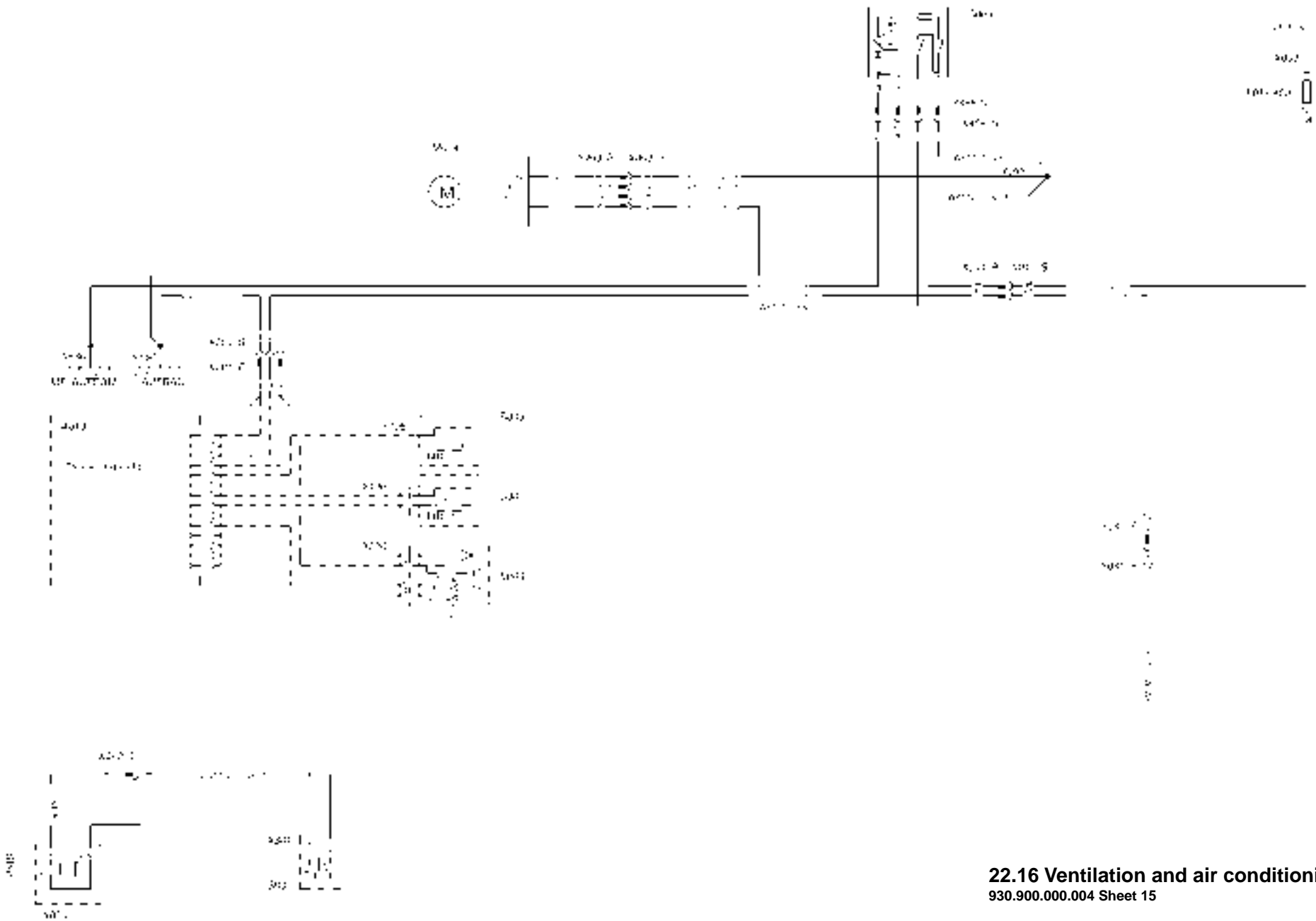

22.16 Ventilation and air conditioning
930.900.000.004 Sheet 15

22.17 Heater
930.900.000.004 Sheet 16

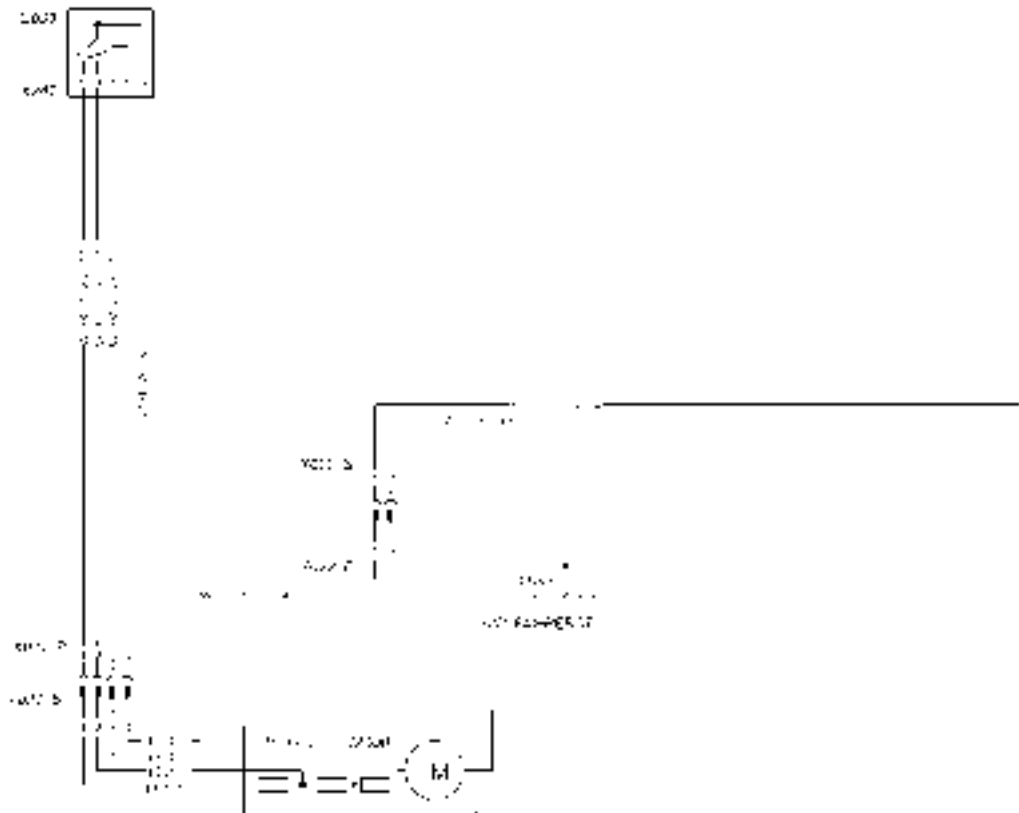

11
12
13
14
15
16
17
18
19
20
21
22
23
24
25
26
27
28
29
30
31
32
33
34
35
36
37
38
39
40
41
42
43
44
45
46
47
48
49
50
51
52
53
54
55
56
57
58
59
60
61
62
63
64
65
66
67
68
69
70
71
72
73
74
75
76
77
78
79
80
81
82
83
84
85
86
87
88
89
90
91
92
93
94
95
96
97
98
99
100

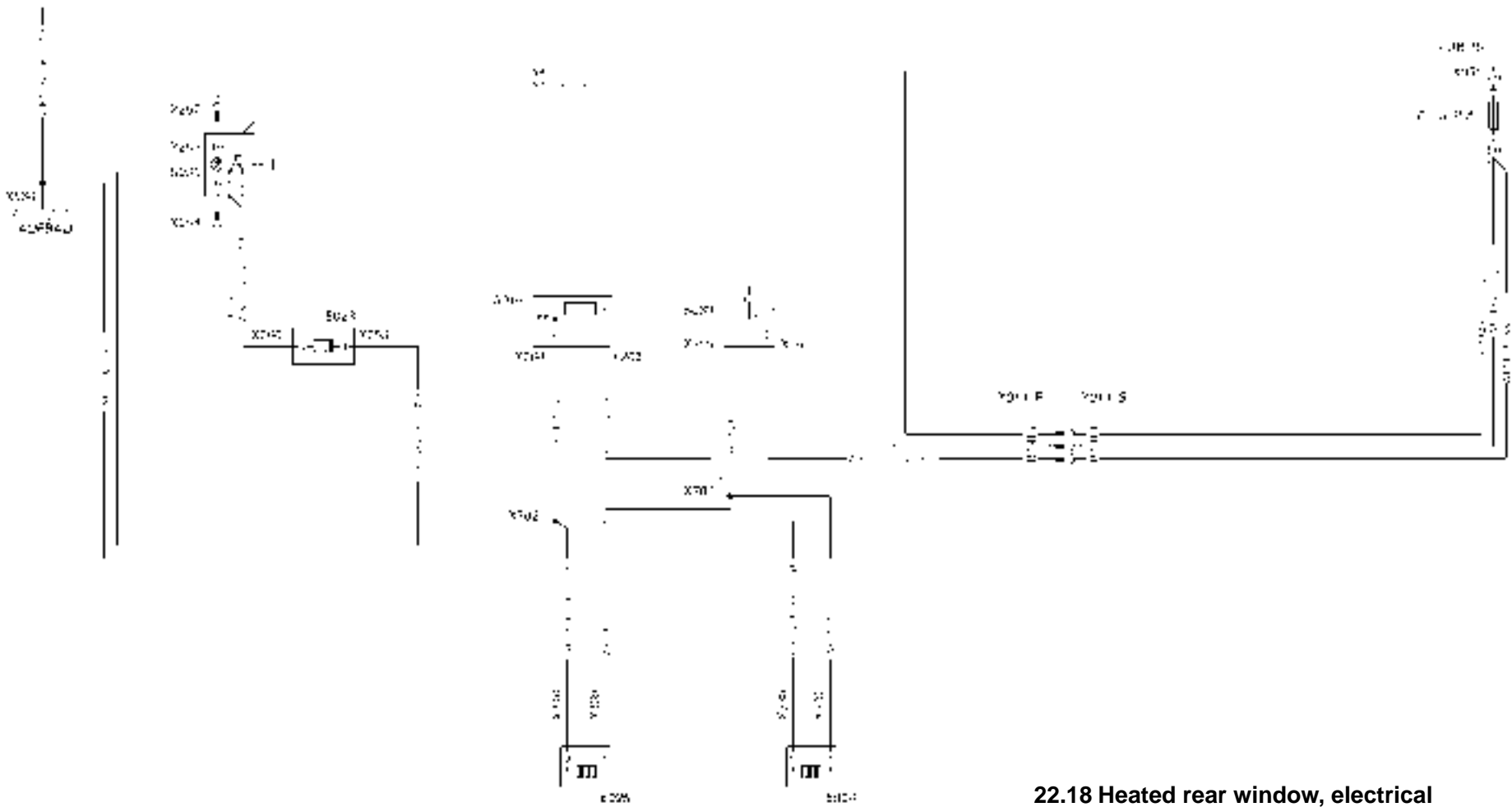

22.18 Heated rear window, electrical mirrors
930.900.000.004 Sheet 17

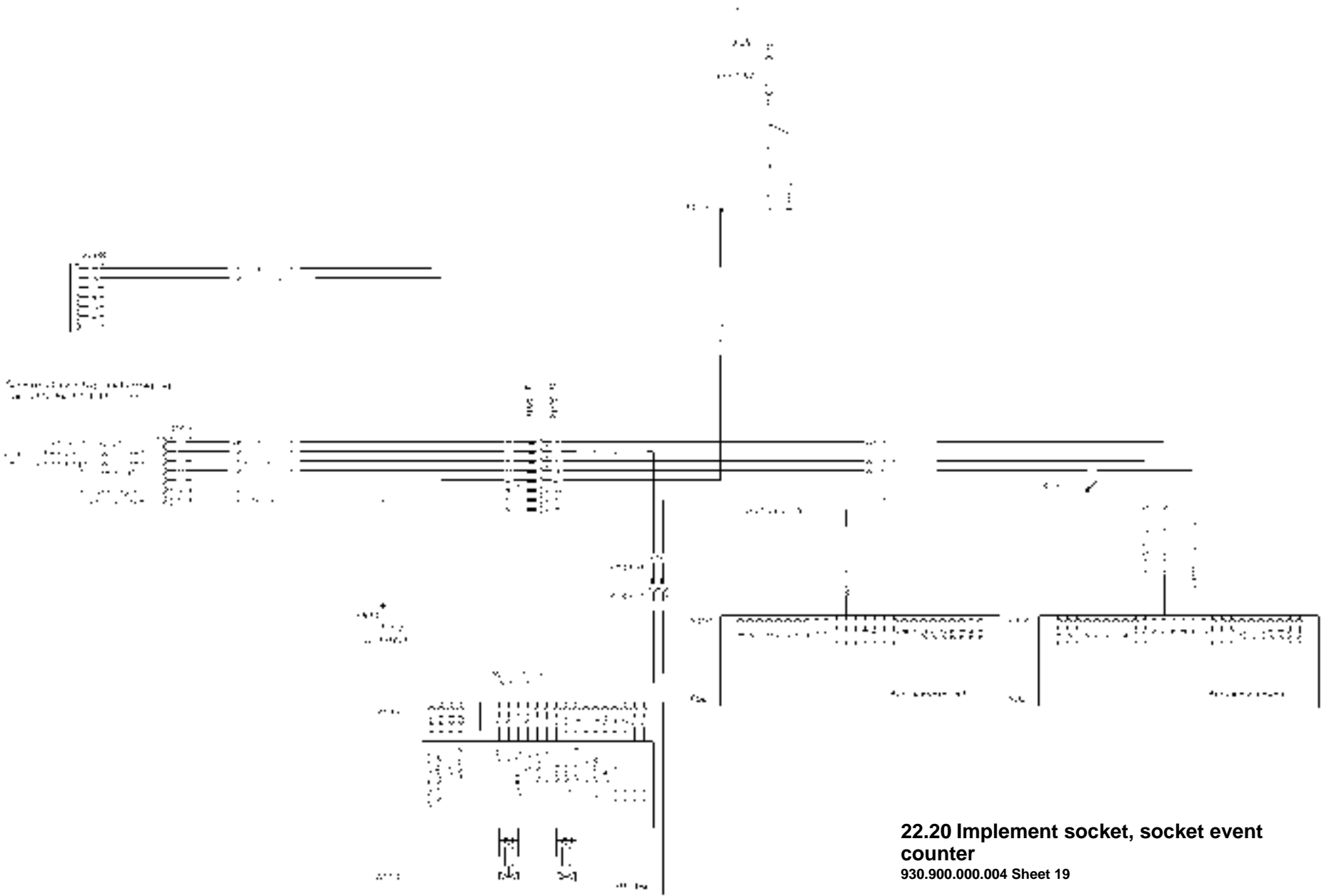

22.20 Implement socket, socket event counter
930.900.000.004 Sheet 19

SPZ:lp

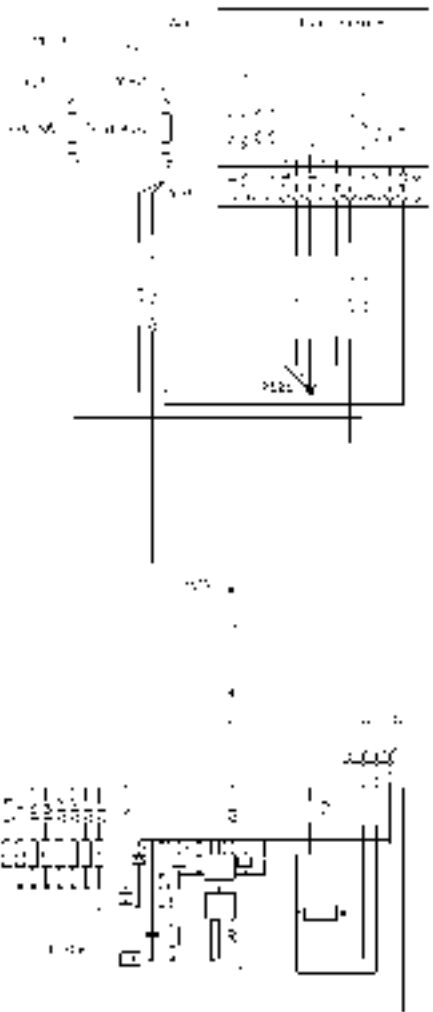

22.21 Electronics power supply
930.900.000.004 Sheet 20

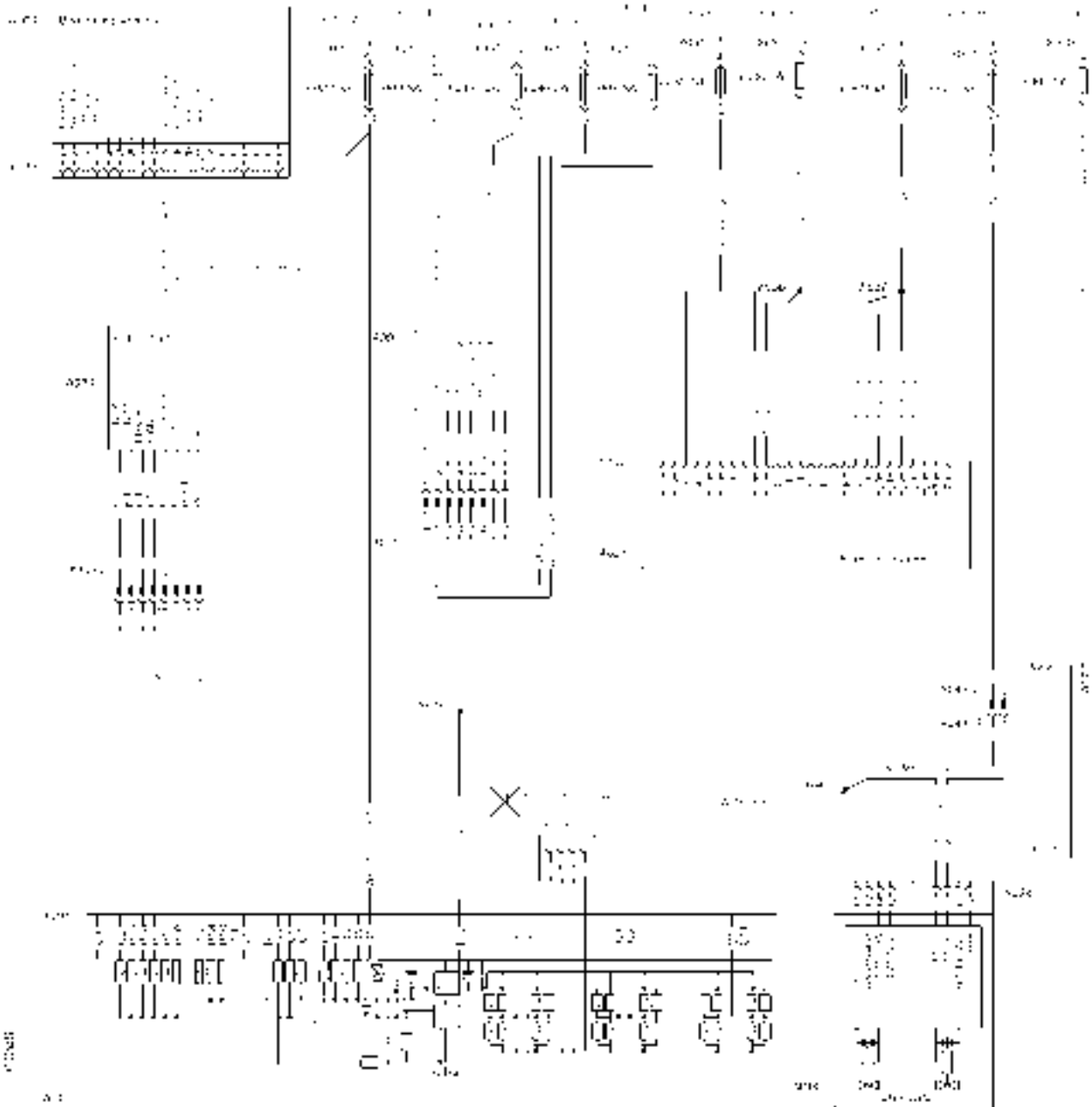

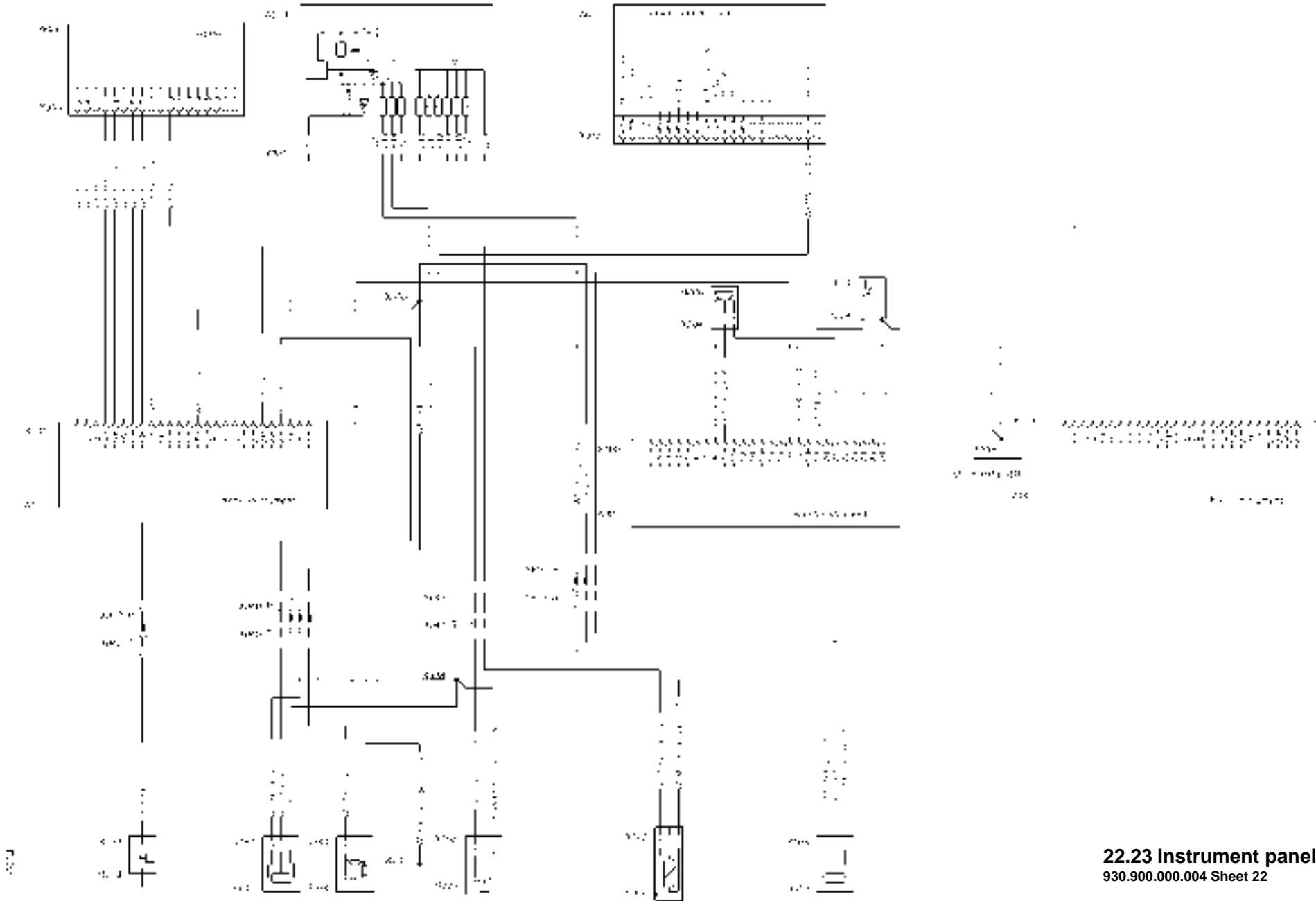

22.23 Instrument panel
930.900.000.004 Sheet 22

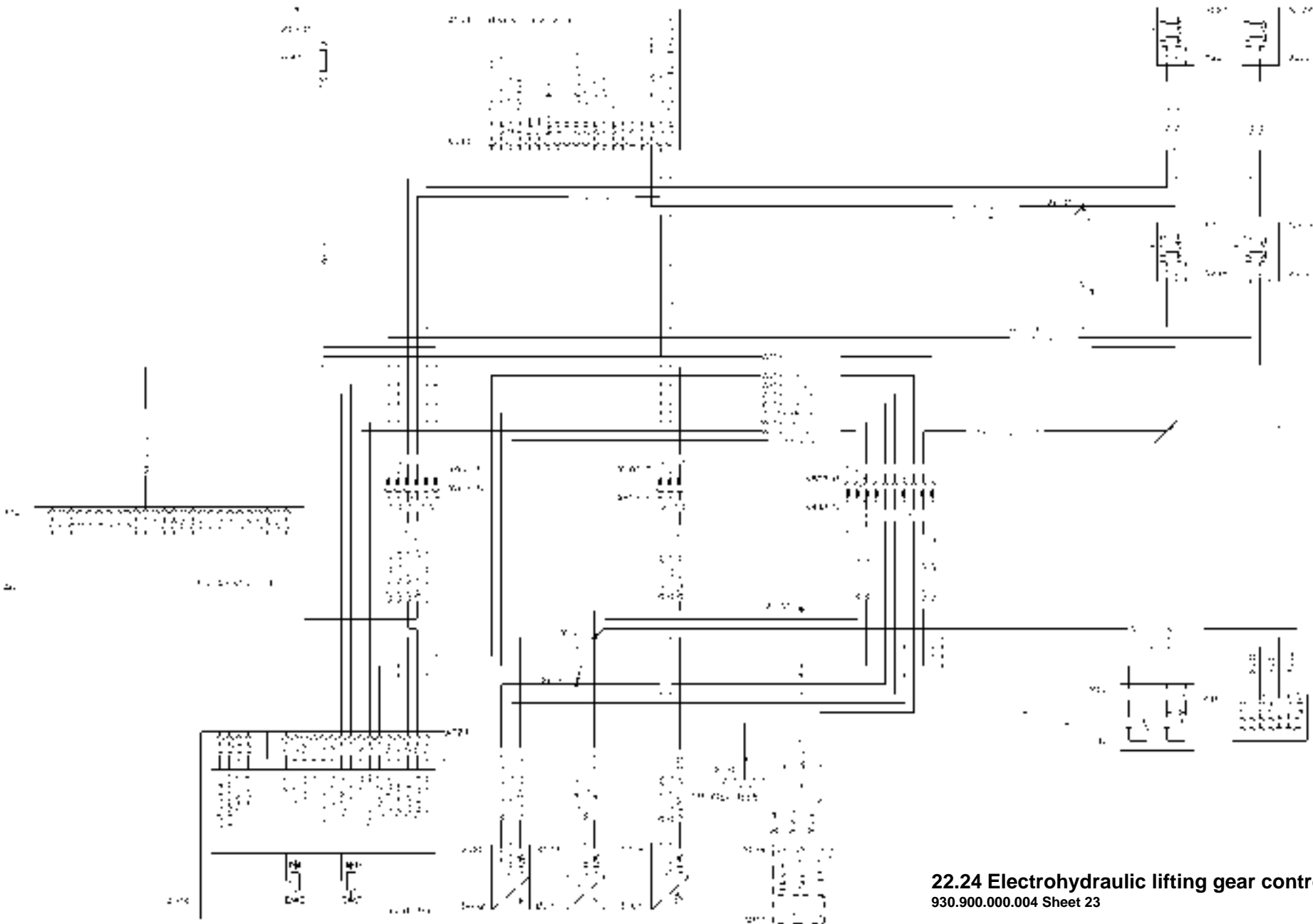

22.24 Electrohydraulic lifting gear control
930.900.000.004 Sheet 23

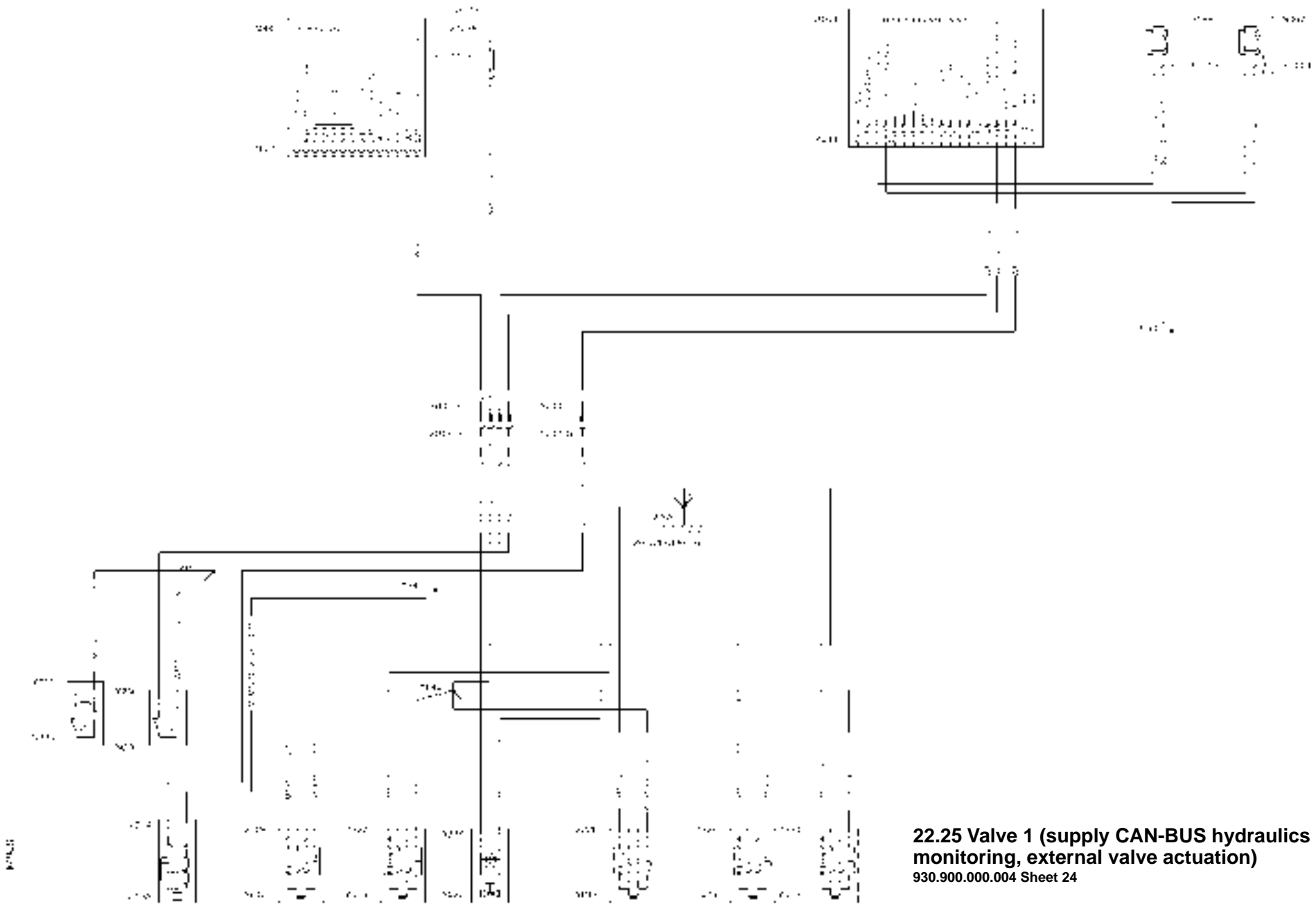

22.25 Valve 1 (supply CAN-BUS hydraulics monitoring, external valve actuation)
930.900.000.004 Sheet 24

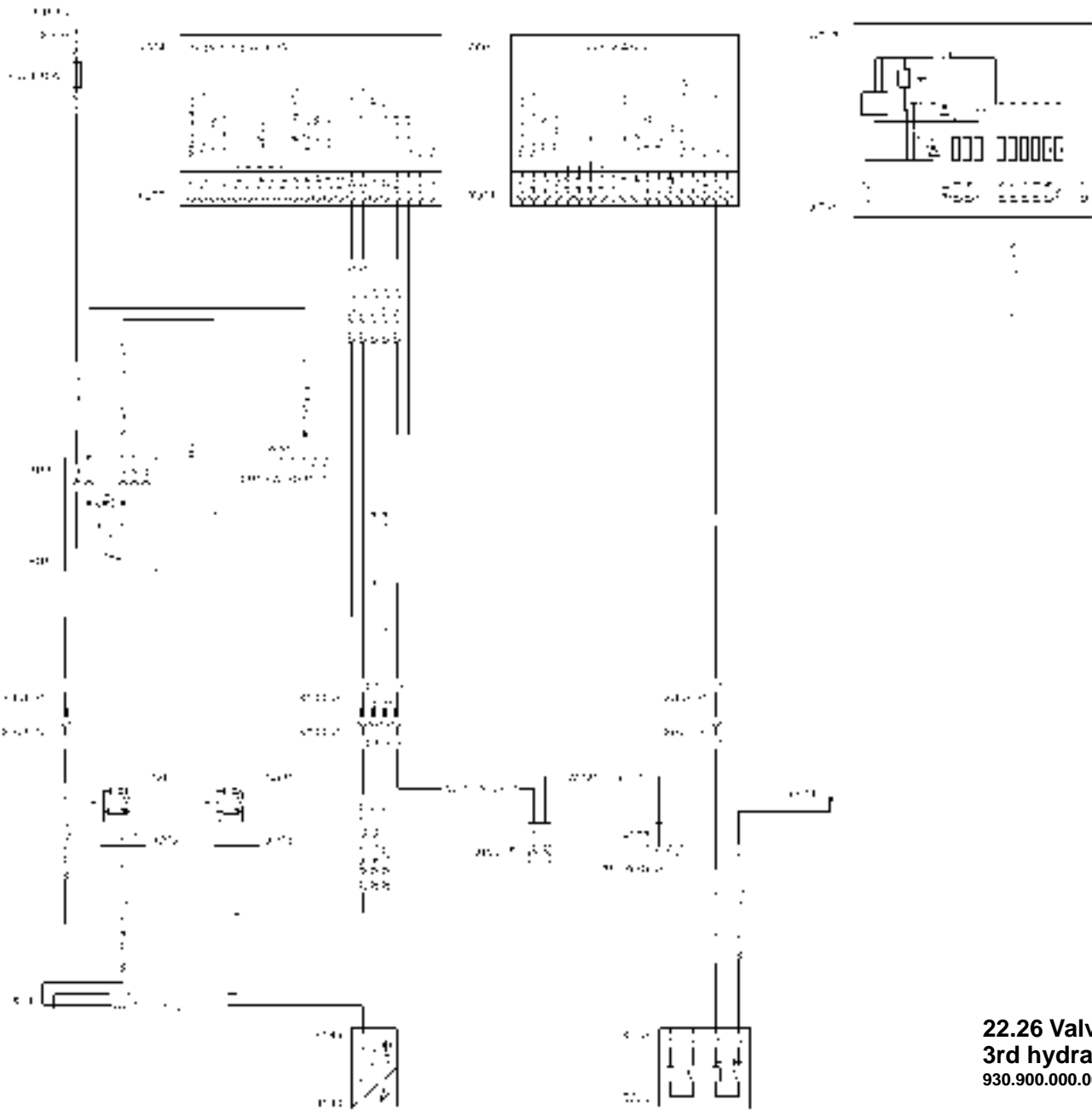

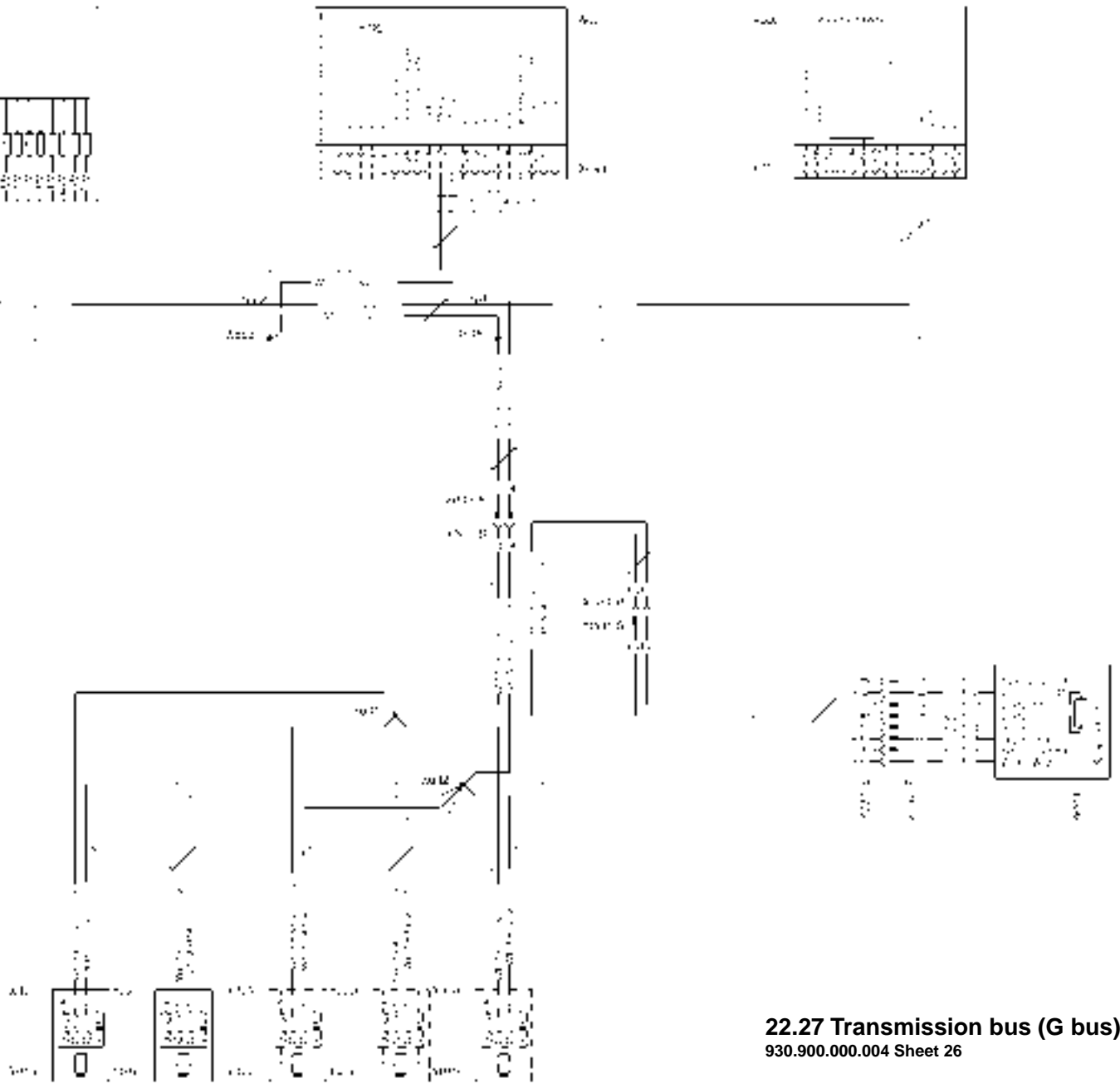

22.27 Transmission bus (G bus)
930.900.000.004 Sheet 26

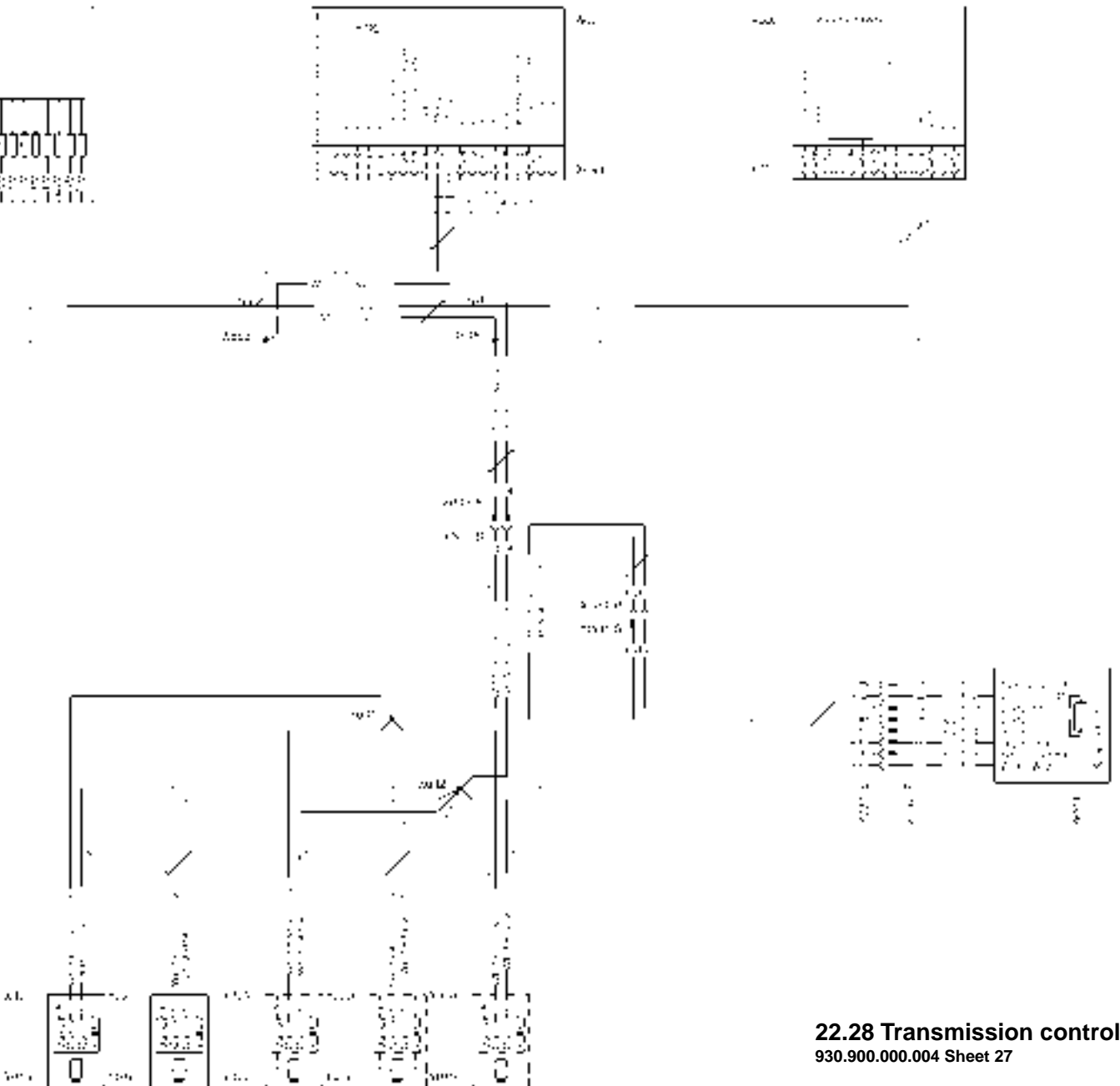

22.28 Transmission control
930.900.000.004 Sheet 27

07/09

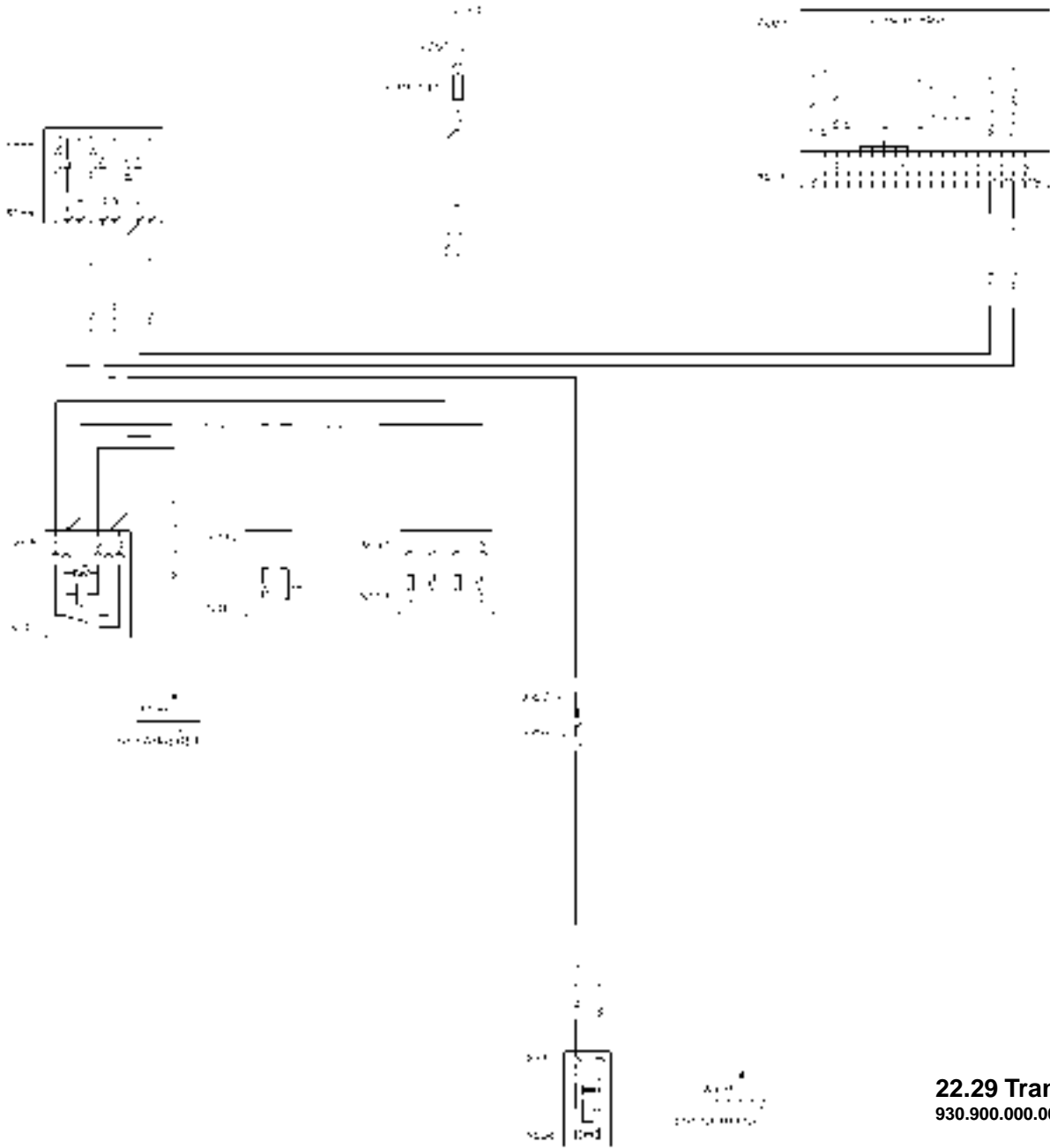

22.29 Transmission emergency operation
930.900.000.004 Sheet 28

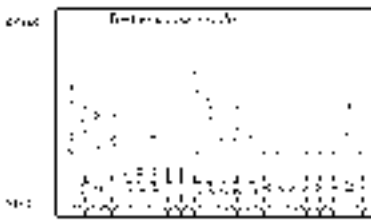
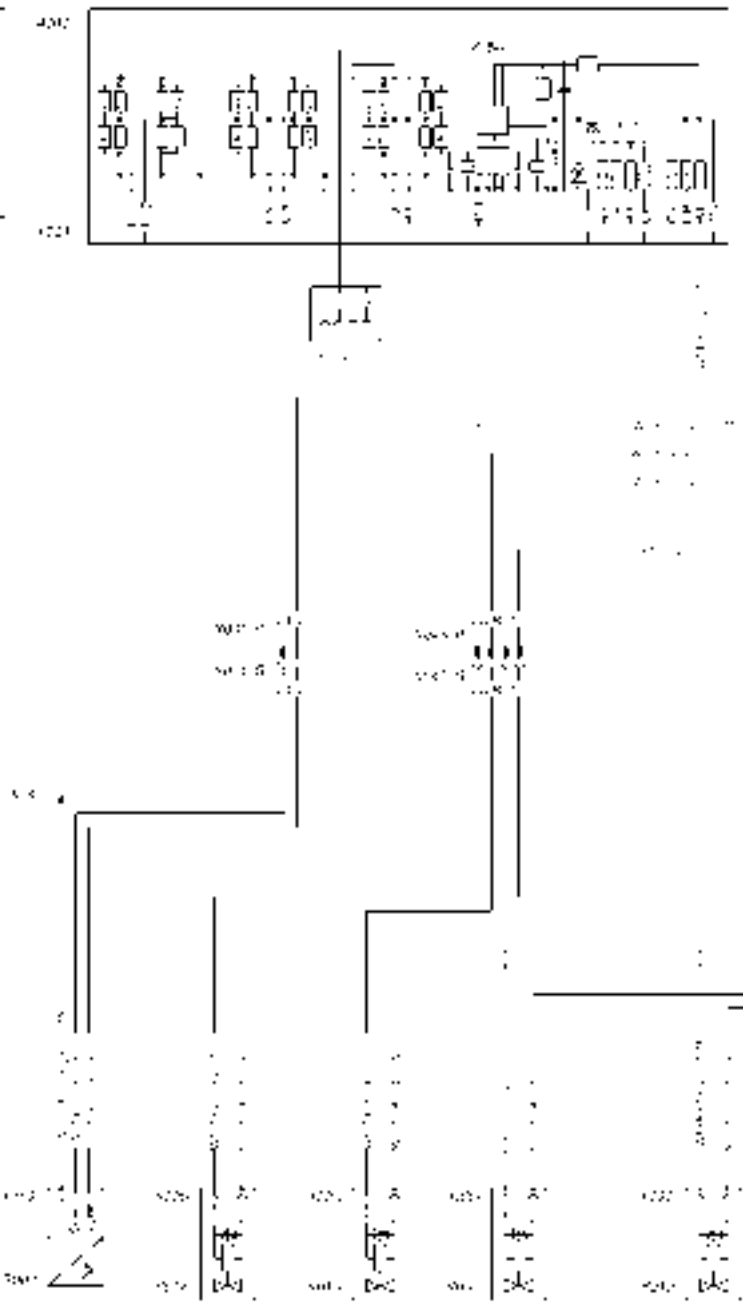
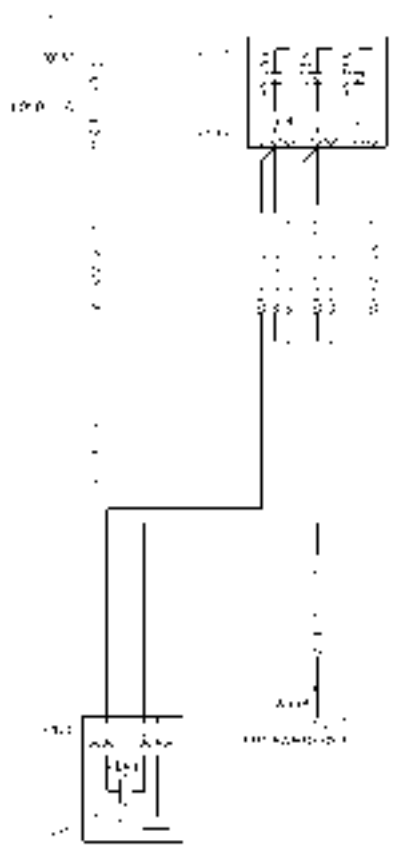

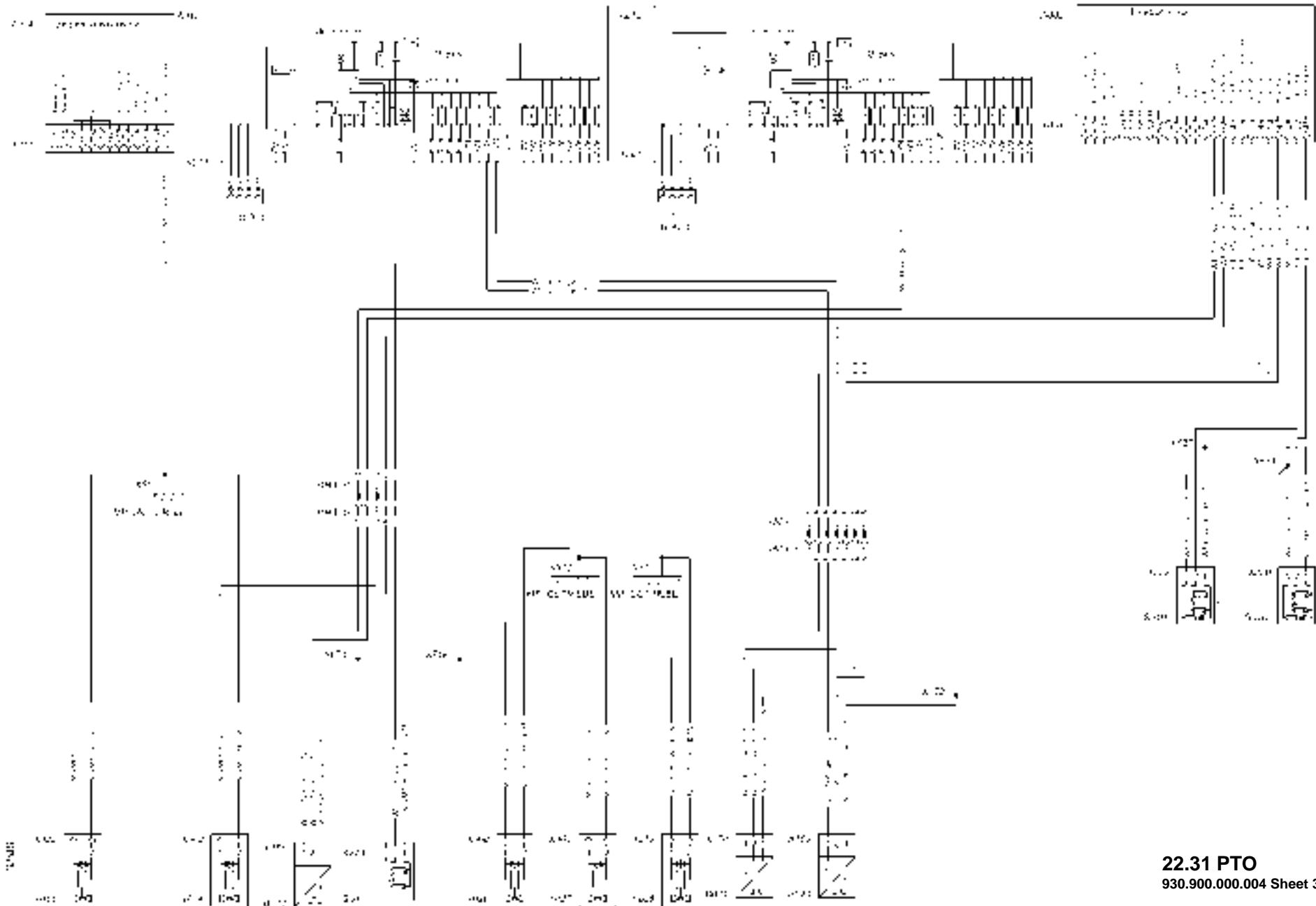

22.31 PTO
930.900.000.004 Sheet 30

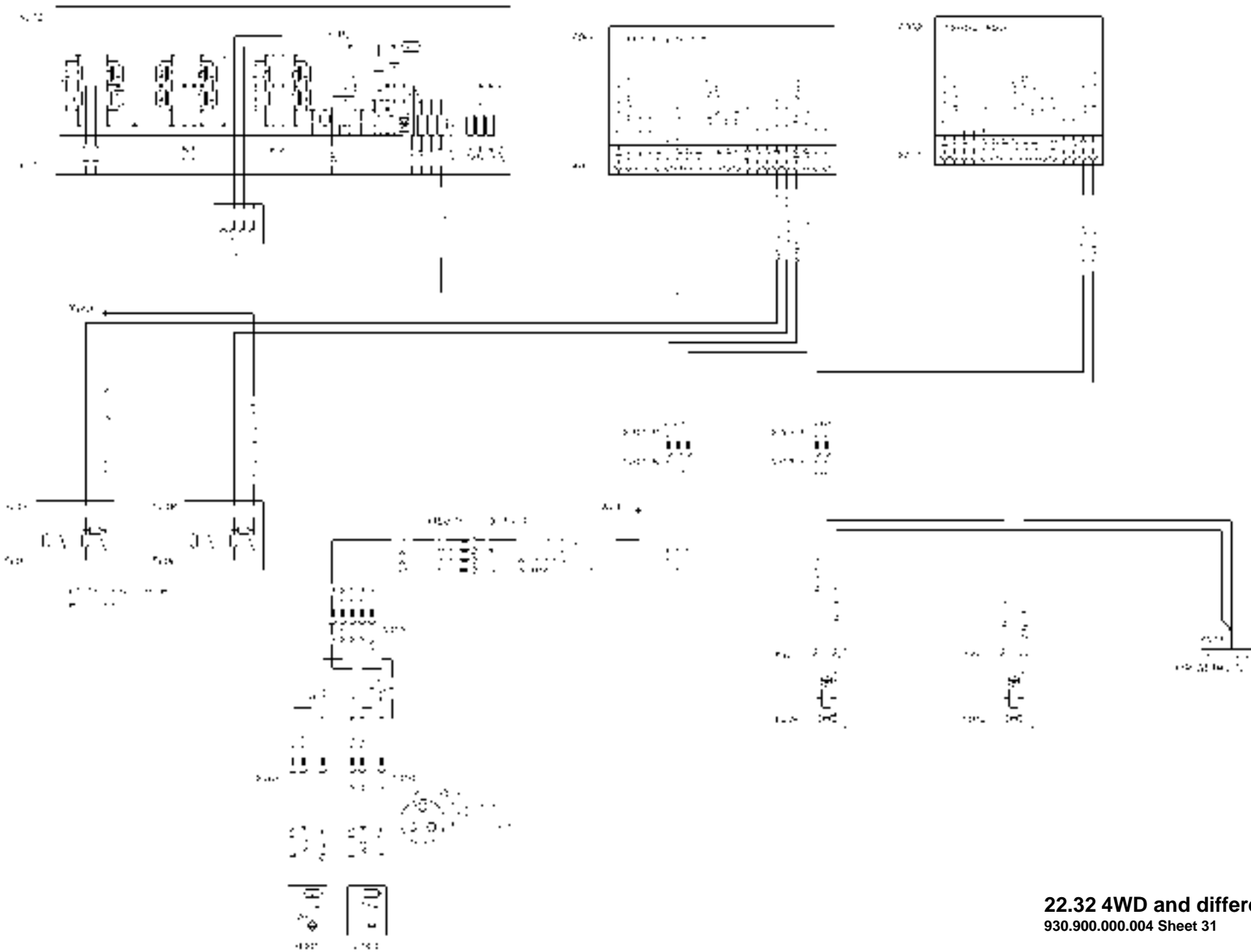

22.32 4WD and differential lock
930.900.000.004 Sheet 31

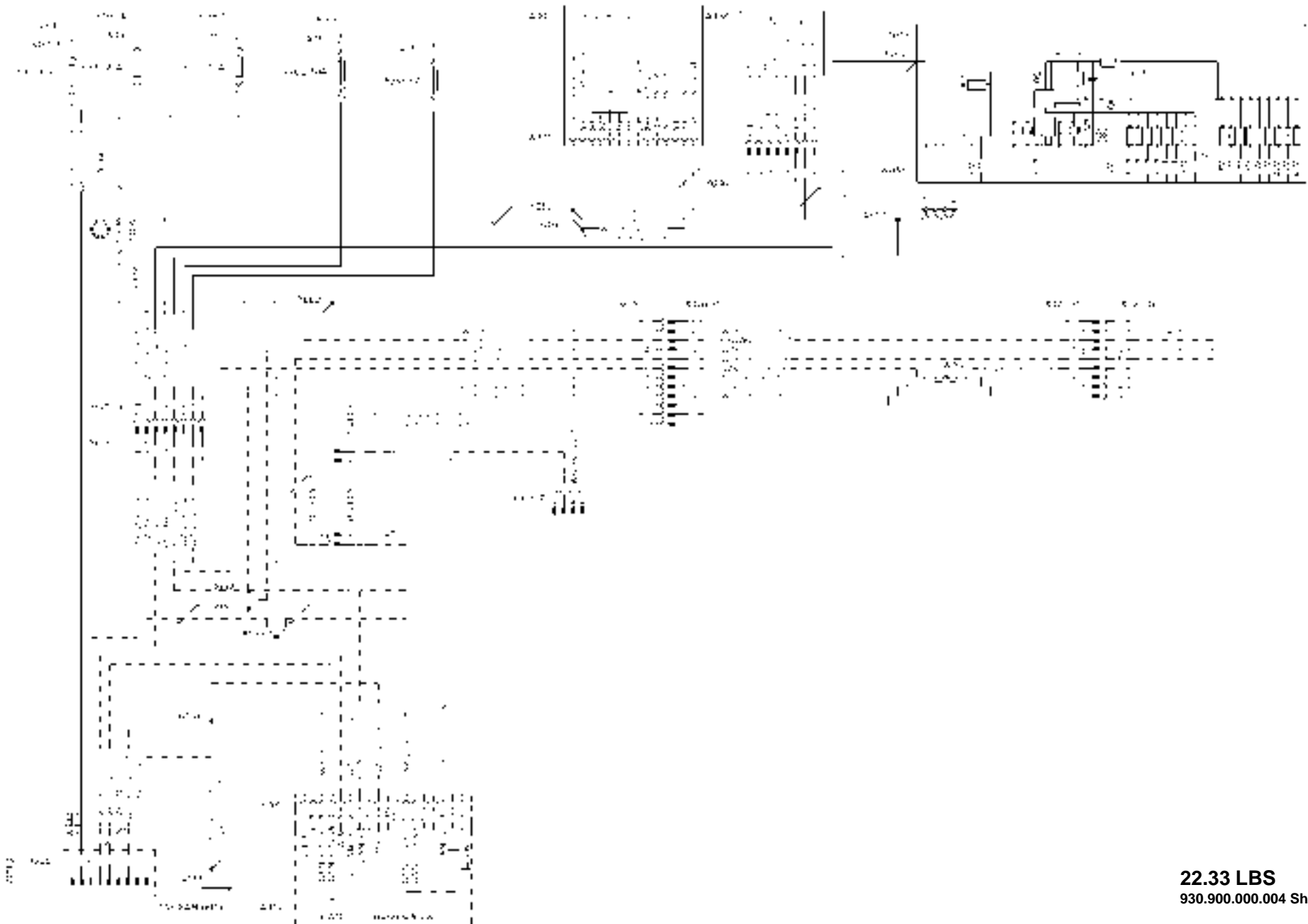

22.33 LBS
930.900.000.004 Sheet 32

1. Reversing device



DANGER:
Use of the reversing device is
forbidden on public roads.

NOTE:

Before changing to reverse mode, switch engine OFF.



Fig.1

The steering column can be swivelled if:

- Steering wheel fully forward.
- Steering wheel fully lowered.
- Push seat forward slightly.
- Adjust seat height to the middle position (hold seat up and let air out).
- Backrest of driver's seat folded forward (on the seat). (if fitted, remove backrest extension).

Pull lever (A) backwards. Turn steering column in clockwise direction. The lock must engage.

NOTE:

In reverse mode, accelerator pedal mode is not available.



Fig.2

Symbol (A) is shown on the multiple display.

Return to previous function.

 Press key and hold.

 Then press button.

1. Warning and fault messages

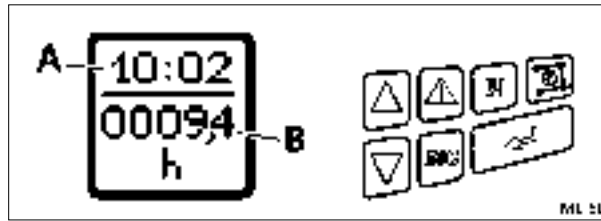

Fig.1

Warning and fault messages are indicated on the multiple display. The warning lamp also flashes and a warning tone is sounded.

Fault codes are stored and can be called up for more accurate definition of the fault. These codes are memorised to be called up in the workshop for rapid fault location.

In normal status, display shows the clock (A) and the number of operating hours (B).

1.1 Warning messages

No fault code, no storage.

Calling up several concurrently existing warnings



Press the button to show the symbols for existing warning messages one after the other. If the button is not pressed for 3 seconds, the symbol for the warning message indicated first reappears.



1. Engine temperature

Display accompanied by a continuous beep and warning light. Unload the engine immediately, then switch off.

Cause

- Clogged radiator fins.
- Not enough cooling water.
- V-belt is loose or torn.
- Thermostat does not open.
- Coolant circuit dirty.
- Viscous fan faulty.

Remedial Action

- Blow or spray fin from inside to outside.
- Top up with warm water while the engine is running.
- Re-tension or change the belt.
- Replace thermostat (workshop task).
- Clean out the inside of the system with hot flushing liquid, e.g. P3 (at workshop).
- Replace viscous fan (at workshop).

FAULTS AND REMEDIAL ACTIONS



2. Engine oil pressure

Display accompanied by a continuous beep and warning light.
Switch off engine immediately.
Check the oil level.

Cause

Engine oil pressure too low as a result of insufficient or excessively thin oil.
Oil control valve in filter head dirty.

Remedial Action

Top up engine oil or fill with correct oil.
Clean oil control valve (workshop task).



3. Charge air temperature

Display accompanied by a continuous beep and warning light.
Unload the engine immediately, then switch off.

Cause

Charge air dirty.
Cracked V-belt.
Viscous fan faulty.

Remedial Action

Check charge air cooler, and clean if necessary.
Replace V-belt.
Replace viscous fan (at workshop).



4. Hydraulic oil temperature

Display accompanied by a continuous beep and warning light.
Relieve the hydraulic system of load and switch off the engine.

Cause

When carrying out hydraulic operations, the control valve does not engage in 'Neutral'.
Three-point implement is non-standard / lateral support set too narrow.
Three-point implement too heavy / overpressure valve continuously activated in upper limit position of power lift.
Insufficient oil supply for the operation concerned.
Final shutoff incorrectly adjusted.

Remedial Action

Set control valve to "Neutral" and lock / have fault corrected at workshop.
Adapt three-point implement to standard / change side support. If necessary make lifting struts longer, if lifting height is sufficient.
Connect upper link to a different point on the implement; measure pressure during the lifting process (at workshop).
Check and top up oil level.
Re-adjust final shutoff (at workshop).



5. Hydraulic oil level (early warning)

Display accompanied by a continuous beep and warning light.
Hydraulic tank could be empty.
Flow rate is limited to 10 l/min for all valves.



6. Contaminated transmission oil filter

Display accompanied by warning light.

Note: Change the cartridge as soon as the display appears. The display may go out again, still change the cartridge.

Cause

Contaminated hydraulic oil filter element.

Remedial Action

Replace filter unit.



7. Excessive transmission oil temperature (95° - only in range II)

Cause

Heavy traction work over extended period in range II.

Cooler soiled.

Turboclutch function active for too long.

Clutch pedal depressed for too long.

Remedial Action

Switch to driving mode I.

Clean the transmission oil cooler.

Increase engine speed (above 1400 rpm).

Release clutch pedal.



8. Transmission oil temperature too high (105°)

Cause

Transmission oil too hot.

Cooler soiled.

Remedial Action

Allow transmission oil to cool down.

Clean the transmission oil cooler.



9. Oil level too low in brake and clutch system

Indication accompanied by intermittent audible signal and warning lamp.

Cause

Oil leakage.

Remedial Action

Check brake system for leaks. If necessary, fill up with hydraulic oil (Pentosin CHF 11 S).

FAULTS AND REMEDIAL ACTIONS



10. Contaminated air filter

Indication accompanied by intermittent audible signal and warning lamp.

Cause

Air filter main cartridge dirty.

Remedial Action

Check air filter main cartridge. If necessary, clean or replace the air filter main cartridge.



11. Instrument cluster memory

Display accompanied by a continuous beep and warning light.

Cause

Invalid programming of combination instrument.

Remedial Action

Re-programme (at workshop).



12. Hand brake on

Indication accompanied by intermittent audible signal and warning lamp.
Note: only when tractor moving.

Cause

Hand brake applied.

Remedial Action

Release parking brake.



13. Engine speed too high

Indication accompanied by intermittent audible signal and warning lamp.

Cause

Engine speed too high.

Remedial Action

Reduce engine speed.



14. Rear PTO on neutral

Display accompanied by warning light.

Cause

PTO speed not preselected.

Remedial Action

Pre-select PTO speed.



15. Engine speed below 500 rpm and turboclutch function switched off

Indication accompanied by intermittent audible signal and warning lamp.

Cause

Engine speed too low.

Remedial Action

Increase engine speed.



16. Front /rear PTO overspeed

Display accompanied by warning light.

Cause

In PTO stage **1000**, from 1170 rpm.

In PTO stage **540E** as of 630 rpm.

In rear PTO **540** setting, from 630 rpm.

Remedial Action

Reduce PTO speed.

Reduce PTO speed.

Reduce PTO speed.



17. Valve prioritisation

Display accompanied by warning light.

Cause

Prioritised valve is requiring more oil than the pump can provide.

Remedial Action

Valve priority is deactivated temporarily until the pump is able to provide the required quantity again.



18. Driving mode selector

Indicator goes off after about 3 seconds.

Cause

Range control oil too cold.

Remedial Action

Repeat operating range selection at oil temperatures above 10°C or shift while at a standstill.



19. Variotronic Ti

Cause

Engine speed below 400 rpm when playback is started.

Remedial Action

Increase engine speed. Start playback again.

FAULTS AND REMEDIAL ACTIONS



20. Driving mode selection not completed. Mechanical neutral position!

Repeat driving mode selection.



21. Variotronic Ti

Cause

Ground speed too low when playback started.

Remedial Action

Increase the ground speed. Start playback again.



22. Variotronic Ti

Cause

Speed greater than 25 km/h when a playback process starts.

Remedial Action

Reduce speed of travel. Start playback process again.



23. Seat switch

Cause

Driver seat empty for more than 3 seconds.

Remedial Action

Sit on the driver seat.

If the Tractor Management System (TMS) is active, engine speed is reduced.

In accelerator pedal mode, the direction of travel must be actuated again while the tractor is actively stopped.

Playback of Variotronic Ti functions must be started again.

1.2 Fault messages

Indication accompanied by intermittent audible signal and warning lamp.

Fault codes are stored and can be called up for more accurate definition of the fault. These codes are memorised to be called up in the workshop for rapid fault location.

In the event of a fault message, proceed as follows:

- Make the system operative by turning ignition off-on (reset).
- If it was a temporary fault, the system is operative again.

If the fault is displayed again:

- Call up fault code and refer to the code table for what measures to take.

Reading out a fault code

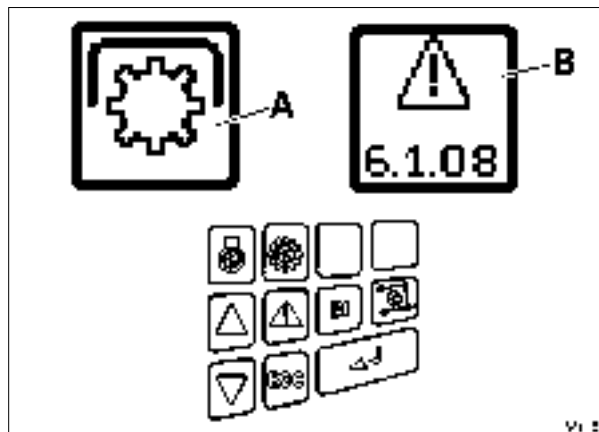

Fig.2



Press button, fault code (B) is shown on the multiple display.

Showing more than one fault message at the same time



If the button is pressed repeatedly, the symbols for all existing faults are displayed one after the other, then symbol (A), code (B), next symbol, next code, and so on. If the button is not pressed for 3 sec., the symbol for the first fault displayed appears again.



1. Four-wheel drive

Try activating with alternate key.
Switching off may no longer be possible.



2. Differential lock

Try activating with alternate key.
Switching on may no longer be possible.

FAULTS AND REMEDIAL ACTIONS



3. Front or rear PTO

Try engaging with another button (5 seconds).



4. EPC rear lifting gear

Move Quick Lift switch fully or turn ignition off and on again.



5. Front power lift

Move Quick Lift switch fully or turn ignition off and on again.



6. Multifunction control lever

Rear/front automatic mode on/off switch faulty.
Automatic mode stop button faulty.



7. Transmission control

Call up fault code and refer to the code table for what measures to take.



8. Sensors

No pressure, speed or volume monitoring.
It is essential to determine the cause of the fault immediately using the code table (see FAULTS AND REMEDIAL ACTIONS Section 5).



9. Electronic system

Display accompanied by a continuous beep and warning light.
Electronic connections between components are faulty or cut. Other fault codes may occur.



10. Indicator lamps

In the event of failure of the forward/reverse indicator lamps, the backup indicators can be activated (see also OPERATION Section 26.5).



R63

11. Failure of (one) steering pump

Display accompanied by a continuous beep and warning light.
Steering pump or control pump failed. Reduce vehicle speed. Contact the workshop immediately and have the fault corrected.



XV1, 42

12. E-box (not EPC)

E-box hardware fault.
Replace corresponding E-box (at workshop).



4201

13. Memory E-box (not EPC)

E-box basic programming invalid
(reprogramming, workshop task).



BFC

14. Front axle suspension

No longer functioning.
Suspension remains in the last position selected.



471, 64

15. Emergency operation

Partial failure of the electronic monitoring system.
Use the emergency mode only to move the tractor out of potential danger or to drive to the workshop.



401 25

16. Excessive transmission slip

Specified/actual transmission slip limit exceeded. This fault may occasionally occur under extreme conditions (e.g. at very low gear oil temperature) even if transmission is mechanically sound. If the problem persists in normal operating conditions, contact the workshop immediately.



1111

17. Hydraulic (oil level)

Hydraulic tank empty.
Valves, front power lift and rear EPC are locked.

Refill hydraulic oil or switch the valve to floating position manually, so that oil can flow back out of the external cylinder (see also OPERATION Section 17.4).

Switch ignition OFF and ON (Reset).



FFH 17

18. Hydraulic valves

Valve remains incorrectly positioned or goes into neutral.

FAULTS AND REMEDIAL ACTIONS



19. Hydraulic valves (crossgate lever)

Valves cannot be actuated.



20. Hydraulic valves (oil temperature)

Hydraulic oil temperature too low.
Operate until the oil has warmed up and unlock the valve again.



21. Hydraulic valves (manual operation)

After manual operation, the valves cannot only be operated again with the crossgate lever or toggle switches after a Reset (engine OFF then ON).



22. Engine coolant (level)

Level of coolant too low.
Top up with coolant.



23. Initialisation error on communication driver

CAN bus communication restricted.



24. Fault of mounted implement in implement control mode

Impossible to control the mounted implement via Vario Terminal.
Check operating manual of the implement manufacturer or contact their service.



25. Right or left draft sensing pin overloaded

Relieve right or left draft sensing pin of load.



26. Seat switch defective

In accelerator pedal mode, the driving direction must be re-entered if the tractor is in active stationary mode.
Variotronic Ti functions cannot be played back.



27. Fault in the Variotronic Ti

One or more functions defective.
Variotronic Ti functions cannot be played back.



28. Memory function

One or more functions faulty when activating the memory function.
Start tractor again, if the fault message is still there. Call workshop.



29. Fault in Tractor Management System

Restricted operation. Call workshop.



30. Fault in the PTO power lift automatic function

Call workshop.



31. When starting tractor, activating key depressed or jammed

Release activating key.



32. Plausibility error accelerator rotary control

Accelerator mode is no longer possible.



33. Driving mode selector calibration error

Calibrate the driving mode selector.

1.3 Clearing a warning or fault message

 Press key and hold.

 Then press button.

Each stored fault messages must be cleared individually. Clearing a fault message does not remove the fault, it is simply no longer displayed.

If the fault is still present, it is indicated again the next time the tractor is started.

FAULTS AND REMEDIAL ACTIONS

1.4 General faults

1. Engine does not start	
<u>Cause</u> Air in the fuel system. Fuel system clogged with dirt. In very cold conditions: failing cold-start system. In winter, at temperatures under -5 °C: fuel feed blocked by ice or paraffin. No starter contact / faulty starter unit. No power supply to electric shut-off.	<u>Remedial Action</u> Bleed air from the fuel system. Clean the filter inlet. If necessary, change filter box; vent system. Flame heater system needs repair (in workshop). Unblock filter duct and fuel filter. Use to winter-grade fuel. Bleed air from system. Main shift lever in neutral (starter lockout!). Check power connection of battery starter. Check fuses and connectors.
2. Engine cuts out	
<u>Cause</u> Air in the fuel system. Fuel system clogged with dirt. In winter, at temperatures under -5 °C: fuel feed blocked by ice or paraffin.	<u>Remedial Action</u> Bleed air from the fuel system. Clean the filter inlet. If necessary, replace filter element. Bleed air from system. Unblock filter duct and fuel filter. Use to winter-grade fuel. Bleed air from system.
3. Poor engine performance	
<u>Cause</u> Fuel filter soiled. Fuel delivery pump dirty. Engine brake is not fully open. Turbocharger: leaky intake system / charger damaged.	<u>Remedial Action</u> Replace filter box. Bleed air from the fuel system. Clean supply pump and bleed air from the system (workshop task). Check engine brake (setting and ease of operation). Check intake and exhaust ducts / check turbocharger (workshop task).
4. Engine produces a lot of smoke	
<u>Cause</u> Injection nozzles not working properly. Injection volume / start of delivery incorrectly set.	<u>Remedial Action</u> Check pressure and spray pattern of nozzles (at workshop). Adjust settings (at workshop).
5. Engine causes a lot of noise	
<u>Cause</u> Imbalance on fan shroud due to soiling.	<u>Remedial Action</u> Clean the fan shroud.

FAULTS AND REMEDIAL ACTIONS

6. Tractor does not start off

<u>Cause</u>	<u>Remedial Action</u>
Actuator not functioning.	Mechanical Auxiliary mode.
No operating range selected.	Select operating range I or II. Use auxiliary lever, if necessary.
Adjustment not functioning.	Measure servo pressure (too low).
Inlet circuit does not work.	Measure feed and outlet pressure.
Leak in the main circuit.	Measure feed and outlet pressure.
Internal leak in the main circuit.	Check transmission characteristic (at workshop).
High-pressure limiting valve does not shut.	Measure control pressure.
Flush valve stuck open.	Start off in the other direction of travel
Transmission characteristic not programmed.	Record the transmission characteristic (at workshop).
Rpm adjustment not set.	Set the rpm adjustment.

7. Transmission oil temperature too high

<u>Cause</u>	<u>Remedial Action</u>
Cooler soiled.	Clean the radiator.
Heavy traction in operating range II.	Switch to driving mode I.
Clutch operated over extended period.	Fully engage the clutch.
Turboclutch function active for long period.	Increase engine speed.
Leak in the main circuit.	Measure feed and outlet pressure.
Leakage in feed circuit.	Measure feed and outlet pressure.
Leakage in outlet line.	Measure outlet pressure.
High-pressure limiting valve does not shut.	Measure control pressure.
Internal leak in the main circuit.	Check transmission characteristic (at workshop).

8. Interruption of tractive power while reversing or during acceleration-deceleration changes

<u>Cause</u>	<u>Remedial Action</u>
Flush valve stuck open.	Replace purge valve.
High-pressure limiting valve does not shut.	Replace high-pressure limiting valve.

9. Tractor no longer reaches maximum speed

<u>Cause</u>	<u>Remedial Action</u>
Incorrect transmission calibration.	Record the transmission characteristic (at workshop).
Adjustment does not function properly.	Measure servo pressure (too low).
Leak in the main circuit.	Measure feed and outlet pressure.

FAULTS AND REMEDIAL ACTIONS

9. Tractor no longer reaches maximum speed

Valve for mechanical speed limitation either faulty or incorrectly set.	Replace valve.
Fuel filter soiled.	Replace filter box. Bleed air from the fuel system.
Intercooler pressure too low.	Check the charge air pressure.

10. Tractor does not pull

<u>Cause</u>	<u>Remedial Action</u>
Feed quantity too flow.	Measure feed and outlet pressure.
Leak in the main circuit.	Measure feed and outlet pressure.
High-pressure limiting valve does not shut.	Measure control pressure.
Flush valve stuck open.	Drive in opposite direction of travel.

11. System pressure too low

<u>Cause</u>	<u>Remedial Action</u>
No feed for servo pump.	Check lubricating pressure.
Servo pump does not deliver.	Check servo pump pressure.
Leakage in pressure or suction line.	Check oil level in clutch housing (too high).
40 bar pressure limiting valve does not close.	Measure servo pump pressure (= lubrication pressure).
18 bar pressure control valve does not close.	Measure feed pressure (= system pressure).
Leak in comfort circuit.	Measure feed pressure, visual check.

12. Inlet pressure too low

<u>Cause</u>	<u>Remedial Action</u>
No feed for servo pump.	Check lubricating pressure (= 0)
Servo pressure less than 18 bar.	Measure servo pressure.
Leak in comfort circuit.	Measure servo pressure, visual check.
Leak in feed line.	Measure output pressure (too low).
Leak in outlet line.	Measure output pressure (too low).
Hydrostatic drive leaks or lifts off.	Measure output pressure (too low).
High-pressure valve is loose.	Measure output pressure (too low).
Output pressure control valve does not shut.	Measure output pressure (too low).
Input pressure control valve does not shut.	Measure output pressure (= input pressure).

13. Output pressure too low

<u>Cause</u>	<u>Remedial Action</u>
Input pressure too low.	Measure input pressure (too low).
Leak in outlet line.	Measure input pressure (under load too low, without load OK).

FAULTS AND REMEDIAL ACTIONS

13. Output pressure too low

Hydrostatic unit leaks.	Measure input pressure (too low).
High-pressure valve is loose.	Measure feed pressure (too low), tighten.
Outlet pressure limiting valve does not close.	Output pressure = pre-cooler flow pressure.

14. Battery charge indicator lamp lit

<u>Cause</u>	<u>Remedial Action</u>
Contact problem on alternator connector.	Check connectors (in workshop).
Cable from alternator to charging indicator lamp has interrupted ground connection or wire.	Eliminate the short circuit (in workshop).
Fault in alternator.	Check the alternator. Repair, or replace if necessary (at workshop).

15. No reading on the digital display

<u>Cause</u>	<u>Remedial Action</u>
Interrupted power supply.	Replace fuse and check connectors. Check fuses and connectors.

16. General faults in the electrical system

<u>Cause</u>	<u>Remedial Action</u>
No contact between terminals and battery cables.	Remove any oxidation from terminals and clamps, tighten the clamp screws; coat terminals with anticorrosion grease.

17. Turn signal / hazard warning system not functioning

<u>Cause</u>	<u>Remedial Action</u>
Power supply interrupted; hazard warning flasher inoperative.	Check fuse / power supply and replace signal pulse generator if necessary.

18. Turn signal indicator lamps do not come on

<u>Cause</u>	<u>Remedial Action</u>
Bulbs faulty in corresponding turn signal lamps on tractor or trailer.	Replace bulbs; establish current / ground contact; check trailer cable connectors.

19. Brakes do not function properly (to be dealt with at the service workshop)

<u>Cause</u>	<u>Remedial Action</u>
Brake pedals have too much free travel / uneven braking effect.	Adjust foot brake, repair if necessary.
Brake pedal movement is spongy and too long.	Bleed air from the foot brake circuit. Eliminate cause of leak, as necessary.
Oil loss in brake and clutch system.	Remedy the cause of oil loss.

FAULTS AND REMEDIAL ACTIONS

20. Electronic control hydraulics (EPC) rear, position control at front not functioning.

<u>Cause</u>	<u>Remedial Action</u>
Safety lock active.	Press quick lift switch beyond Stop position until indicator lamps light up.
Rear EPC: lifting gear switched to operation with dual-action additional control unit / lever cannot be changed over.	Relieve the lifting gear of load, switch off engine, switch the lever fully and release the safety lock.
Lifting height limitation is set to min. lift.	If necessary, increase lift.
Fuses blown.	Change fuses.

21. Fault in the lifting gear control

<u>Cause</u>	<u>Remedial Action</u>
For example, loose electrical connections, failure of an electronic component, etc.	Call up fault code on the multiple display, if necessary contact the after-sales service workshop.

22. Slip control operating inaccurately

<u>Cause</u>	<u>Remedial Action</u>
Speed signals in the EPC E-box are inaccurate.	Adjust the radar sensor.

23. Hydraulic traction control unsatisfactory (insufficient number of governor pulses)

<u>Cause</u>	<u>Remedial Action</u>
Position / traction setting is set too far towards Position.	If necessary, set more towards 'Traction.
Plough blade is blunt (no cutting action).	Sharpen plough blade.
Working implement unsuitable for control hydraulics.	Use an implement suitable for the control hydraulics.

24. Lifting gear does not lower

<u>Cause</u>	<u>Remedial Action</u>
Lowering speed setting too far towards. No lowering.	If necessary, set more towards "Max. lowering speed".

25. Excessive noise in hydraulic system

<u>Cause</u>	<u>Remedial Action</u>
Hydraulic oil still cold.	Let engine run for a few minutes at average speed before any hydraulic work.
Insufficient oil in the hydraulic oil reservoir.	Top up oil level in accordance with specifications.
Air drawn in through suction line connections or pump shaft seal.	Seal the connections and/or replace the hydraulic pump (at workshop).
Suction filter soiled.	Replace suction filter.

FAULTS AND REMEDIAL ACTIONS

26. Hydraulic system does not lift

<u>Cause</u>	<u>Remedial Action</u>
Hydraulic oil still cold.	Let engine run for a few minutes at average speed before any hydraulic work.
Insufficient oil in the hydraulic oil reservoir.	Top up oil level in accordance with specifications.
Air drawn in through suction line connections.	Seal the connections (at workshop).
Suction filter soiled.	Replace suction filter.

27. Heater ineffective

<u>Cause</u>	<u>Remedial Action</u>
Heating water valve is partially closed / air filter dirty.	Open the heating water valve / replace air filter.

28. Heater fan not working

<u>Cause</u>	<u>Remedial Action</u>
Power supply to blower interrupted or blower failed / blocked.	Check fuse / power supply, remove foreign bodies (in workshop).

29. Air-sprung seat fails to adjust

<u>Cause</u>	<u>Remedial Action</u>
Compressed air compressor not functioning.	Check fuse / power supply.

30. Air conditioning does not work

<u>Cause</u>	<u>Remedial Action</u>
Fresh air fan not switched on / not functioning / temperature selector set at '0'.	Switch on fan / set temperature selector to desired outlet air temperature / check fuse and power supply.
AC compressor not functioning - magnetic clutch not engaging / V-belt is too slack or cracked.	Check fuse / power supply for magnetic clutch or V-belt.
Insufficient refrigerant in the system (system on, engine speed 2,000 rpm; ball must be floating in sight glass on fluid reservoir).	Top up refrigerant (at workshop).

31. Cooling effect of air conditioning inadequate

<u>Cause</u>	<u>Remedial Action</u>
Condenser dirty (upstream of engine radiator).	Blow out or spray condenser from inside out.
Fresh air/ recirculating air filter dirty.	Blow out recirculated air filter, tap out the fresh air filter; replace if necessary.
Evaporator iced up.	Reset temperature selector; have the cause rectified (at workshop).
Insufficient refrigerant in the system (system on, engine speed 2,000 rpm; ball in sightglass of fluid tank must be floating).	Top up refrigerant (at workshop).

FAULTS AND REMEDIAL ACTIONS

32. Blue ball in fluid tank turned pink

<u>Cause</u>	<u>Remedial Action</u>
Dryer in fluid reservoir is saturated.	Replace fluid reservoir (workshop job - refer to workshop manual, air conditioning section).

33. Water drips from fan casing (air conditioning)

<u>Cause</u>	<u>Remedial Action</u>
Condensation outlet blocked (line ends at left and right cab access ladders).	Clear the water outlet (blow through if necessary).

2. Variotronic Ti fault messages

Fault messages are displayed as symbols on the Vario terminal.

Each stored fault messages must be cleared individually. Clearing a fault message does not remove the fault, it is simply no longer displayed.

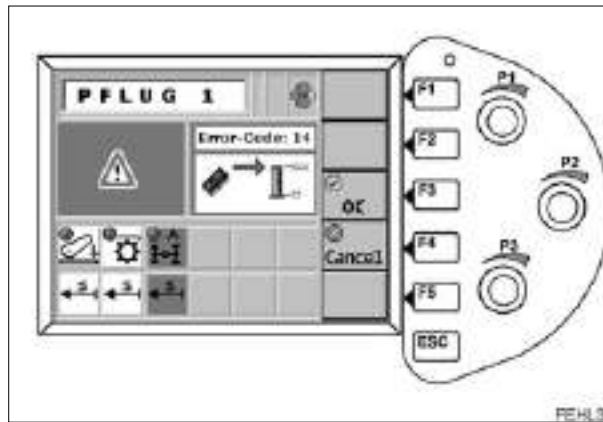

Fig.3

- Press key (F3). Confirm fault message.
- Press key (F4). Cancel process.



1. Fault in a sub-function

Read error code from the multi-display. Consult workshop.



2. Memory fault (EEPROM)

If this occurs several times, consult workshop.



3. Memory fault (system)

If this occurs several times, consult workshop.

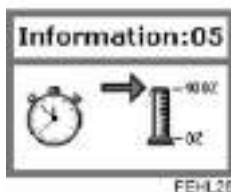

4. Specified/actual value error

Process is cancelled.

FAULTS AND REMEDIAL ACTIONS

5. Timeout exceeded (max. 120 seconds)



Process is cancelled.

6. Distance exceeded (max. 300 meters)

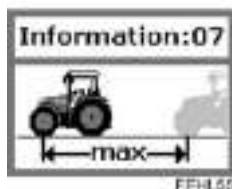

Process is cancelled.

7. No configuration available

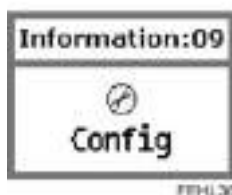

Create configuration. Start recording again.

8. Communication error on operating console

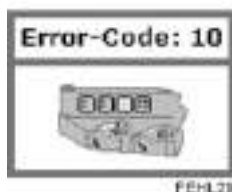

Call workshop.

9. Joystick faulty



Call workshop.

10. Automatic mode memory error

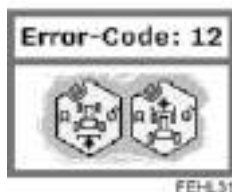

Call workshop.

11. Fault in a sub-function



Read error code from the multi-display. Consult workshop.

12. Button on joystick faulty



Call workshop.

13. Button on control terminal faulty



Call workshop.

14. Rear PTO setting pre-selection

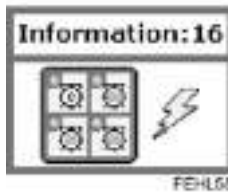

Setting different in recording/playback. Change the setting pre-selection.

15. Memory function

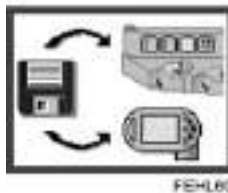

Press F4 key. Latest settings are activated.
Press F5 key. Base settings are activated.

16. Incorrect direction of travel when starting playback



Change the direction of travel (drive forward). Start playback again.

17. Incorrect direction of travel when starting playback



Change direction of travel (to reverse). Start playback again.

18. Automatic mode memory error

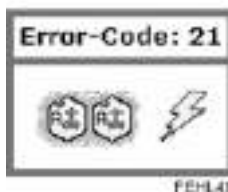

Call workshop.



FEHL30

19. operating sequence too long

Recording is stopped.

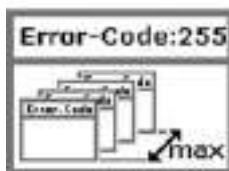

FEHL35

20. Too many fault messages

Confirm fault messages.

3. Warning and information messages for implement settings

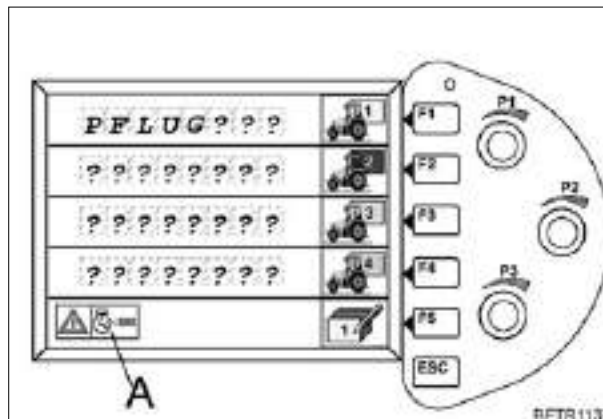

Fig.4

Warning and information messages (A) are shown on the Vario terminal.



1. Engine speed is less than 400 rpm

Process is not started.
Increase engine speed.

FEHL06



2. Transmission not in neutral

Process is not started.
Put transmission into neutral.

FEHL05



3. FRONT power lift/PTO automatic mode active on the operating console

Process is not started.
End **FRONT** power lift/PTO automatic function on the control console.

FEHL02



4. REAR power lift/PTO automatic mode active on the operating console

Process is not started.
Switch off **REAR** power lift/PTO automatic mode on the operating console.

FEHL04



5. FRONT and REAR power lift/PTO automatic mode active on the operating console

Process is not started.
Switch off **FRONT and REAR** power lift/PTO automatic mode on the operating console.

FEHL03



6. Variotronic Ti information message active

FEHL01

4. Flame starting system faults

The flame starting system control unit detects faults in the flame starting system, and indicates these with flash codes on the preheating indicator lamp.

The flashing duration is about 60 secs.

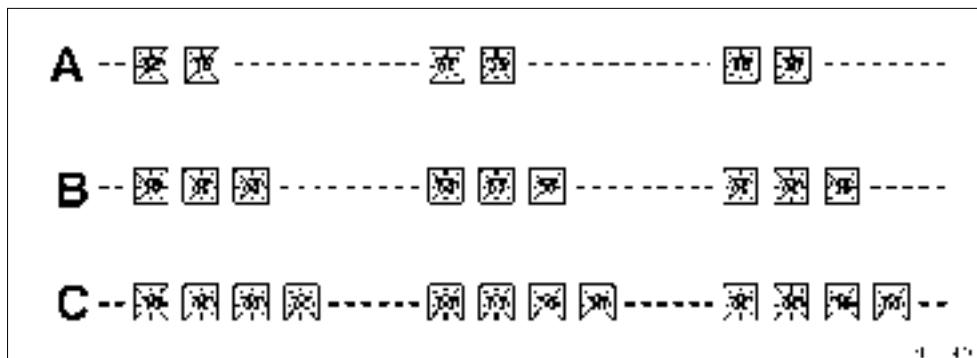

Fig.5

The following faults are detected:

Fault code A:

- Break in the flame glow plug element loop or its supply line.

Fault code B:

- Faulty fuse for the flame start control unit or no supply voltage (B+).

Fault code C:

- Break in the solenoid valve line or coil.

In all cases, only the indicator lamp flashes. Solenoid valve and flame heater plug remain switched off.

5. Fault code tables

General

Fault code	Cause	Effect and remedy
0.0.11 0.0.12 0.0.13 0.0.14 0.0.15 0.0.16 0.0.17 0.0.18 0.0.1A 0.0.20	Data transfer from Tractor electronic system for instrument cluster inoperative.	No forward/reverse indicator, 4-WD, diff. lock and Front/rear PTO speed.
0.0.1B	Variotronic Ti data transfer faulty.	Auxiliary operation.
0.0.1F	Joystick data transfer faulty.	Valves, electronic accelerator, transmission functions not functioning.
0.1.50	Combination instrument not programmed.	Programme combination instrument.
0.1.51	Engine oil pressure sensor faulty.	No more monitoring of engine oil pressure.
0.1.54	Sensor for compressed air supply is faulty.	Display no longer valid.
0.1.55	Hydraulic oil supply sensor faulty.	No monitoring of hydraulic oil level.
0.1.56	Engine temperature sensor faulty.	Engine temperature is not monitored.
0.1.57	Charge air temperature sensor.	No monitoring of intercooler temperature.
0.1.59	Sensor for fuel supply faulty.	No monitoring of fuel supply indicator.

Electronic engine control

Fault code	Cause	Effect and remedy
1.1.01	EDC control unit line discontinuity.	Normal operation - fault indication.
1.1.03	Foot throttle potentiometer plausibility error.	Accelerator pedal mode not functioning.
1.1.04	Tractor Management System (TMS) checksum error.	Tractor Management System (TMS) not functioning, EOL programming.
1.1.05	Engine configuration could not be read by the electrical engine control module.	Tractor Management System (TMS) not operational.
1.1.7 E	FENDT control unit, line discontinuity.	Loss of enhanced features, only foot throttle available.
1.1.7F	Hand throttle memory buttons faulty.	Loss of enhanced features, only foot throttle available.
1.1.9 E	Operating console, line discontinuity.	Loss of enhanced features, only foot throttle available.
1.1.9F	Operating console, line discontinuity.	Loss of enhanced features, only foot throttle available.
1.1.A0	Connection to EDC control unit, EDC control unit faulty.	Normal operation - fault indication.
1.1.A1	FENDT control module to EDC control module connection faulty.	Reduced engine power.

FAULTS AND REMEDIAL ACTIONS

Fault code	Cause	Effect and remedy
1.1.BO	Communication driver initialisation error; limited CAN bus communication.	EOL programming.
1.1.EO	Calibrated values from manual throttle rotary control incorrect.	Manual throttle rotary control calibration.

Electronic engine control

Fault code	Cause	Effect and remedy
1.2.13	Battery voltage too low.	Reduced engine operation.
1.2.17	Engine overspeed.	After the overspeed is left, normal operation.
1.2.18	Start of injection incorrectly set.	Reduced end speed, reduced engine power. Check fuel system.
1.2.1A	Needle movement sensor incorrect values.	Engine control changed.
1.2.9B	Solenoid valve has incorrect values.	Reduced end speed, reduced engine power.
1.2.1E	Injection pump.	Reduced speed, reduced engine power.
1.2.1F	Engine control unit or connection interrupted.	Auxiliary operation.
1.2.21	FENDT control module to transmission bus connection interrupted.	Optimum engine control not possible.
1.2.23	FENDT control module to EDC control module connection interrupted.	Loss of enhanced features, only foot throttle available.
1.2.25	Main relay does not open.	Battery is discharged.
1.2.2A	FENDT control module to EDC control module connection interrupted.	Normal operation - fault indication.
1.2.2B	FENDT control module to EDC control module connection interrupted.	No control of engine brake.
1.2.2C	FENDT control unit connection to engine brake interrupted.	No control of engine brake.
1.2.2D	FENDT control module to EDC control module connection interrupted.	Loss of enhanced features, only foot throttle available.
1.2.2 E	FENDT control module to EDC control module connection interrupted.	Optimum engine control not possible.
1.2.38	Control unit.	Reduced speed, reduced engine power.
1.2.42	Injection pump.	Reduction in power.
1.2.46	Control unit.	Loss of enhanced features, only foot throttle available.
1.2.81	Pedal position sensor signal wrong.	Normal operation - fault indication.
1.2.82	Injection pump, supply of flow.	Engine cuts out, engine does not start.
1.2.84	Engine speed sensor, control module.	Reduced speed, reduced engine power.
1.2.85	Boost pressure sensing device.	Reduced engine power.
1.2.87	Temperature sensor (coolant), control module.	Reduced engine power.
1.2.89	Injection pump.	Engine does not start.
1.2.91	rpm sensor.	Reduced speed, reduced engine power.
1.2.92	Injection pump, engine control module.	Reduced end speed, reduced engine power.

FAULTS AND REMEDIAL ACTIONS

Fault code	Cause	Effect and remedy
1.2.96	Control unit.	Engine cuts out.
1.2.99	Control unit to injection pump connection is interrupted.	Reduced speed, reduced engine power.
1.2.A2	Engine control unit or injection pump.	Reduced speed, reduced engine power.
1.2.A6	Engine control unit or injection pump.	Reduced speed, reduced engine power.
1.2.A8	Engine control unit has wrong value.	Normal operation - fault indication.
1.2.A9	Injection pump.	Reduced end speed, reduced engine power.
1.2.B1	Control unit to injection pump connection is interrupted.	Reduced speed, reduced engine power.
1.2.B2	Control unit, injection pump.	Reduced speed, reduced engine power.
1.2.B3	Interrupted power supply.	Engine stops, engine does not start.
1.2.B4	Control unit to injection pump connection is interrupted.	Loss of enhanced features, only foot throttle available.
1.2.B5	Control unit, injection pump.	Reduced speed, reduced engine power.
1.2.B6	Control unit, injection pump.	Reduced speed, reduced engine power.
1.2.B7	Engine speed sensor.	Reduced speed, reduced engine power.
1.2.B9	Control unit, injection pump.	Engine stops.
1.2.C1	Pump control unit faulty.	Engine goes into idle.
1.2.C3	EDC control module - pump controller connection interrupted.	Engine goes into idle.
1.2.C4	Injection pump.	Engine goes into idle.
1.2.C5	Stop solenoid valve.	Reduced speed, reduced engine power.
1.2.C7	Injection pump, fuel lines faulty.	Engine stops. Check fuel system.
1.2.C8	Control unit, needle movement sensor, boost pressure sensor.	Engine stops.
1.2.C9	Injection pump.	Normal operation - fault indication.
1.2.CA	Injection timing mechanism values not within tolerance.	Reduced rpm, reduced engine power. Check fuel system.
1.2.CB	Control unit to injection pump connection is interrupted.	Loss of enhanced features, only foot throttle available.
1.2.CD	Injection pump.	Reduced speed, reduced engine power.
1.2.DE	Control unit.	Loss of enhanced features, only foot throttle available.
1.2.EO	EDC control unit not connected.	Normal operation - fault indication.
1.2.E1	PTO rpm or speed signal incorrect.	Normal operation - fault indication.

Implement control

Fault code	Cause	Effect and remedy
2.1.EO	CAN communication E-Box - CAN joystick defective.	Implements can no longer be controlled using the joystick.
2.1.EE	LBS job computer inoperative.	Check CAN bus system for implement control.
2.1.EF	Error message from mounted implement.	Refer to implement manufacturer's manual.

FAULTS AND REMEDIAL ACTIONS

Operating console

Fault code	Cause	Effect and remedy
3.1.01 3.1.02 3.1.03 3.1.04 3.1.05 3.1.06	Programming error.	Call workshop.

Transmission

Fault code	Cause	Effect and remedy
4.1.01	Joystick acceleration switch I-IV faulty.	Auxiliary operation.
4.1.04	Clutch pedal potentiometer faulty.	No monitoring of transmission ratios.
4.1.05	Pressure sensor II defective.	Reduced comfort.
4.1.06	Accelerator rotary control faulty.	Load limit control not functioning.
4.1.07	High-pressure sensor faulty.	Peak loads in the transmission are no longer monitored.
4.1.08	Operating range I/II analogue device (function angle device) faulty.	Operating range switching I/II not operational.
4.1.20	Accelerator cancellation rotary control incorrectly calibrated or not calibrated.	Accelerator mode not working.
4.1.21	Reverse mode switch is defective.	Reverse mode operation and accelerator mode no longer possible.
4.1.22	Accelerator cancellation rotary control faulty.	Restriction in operation of accelerator mode.
4.1.23	Joystick signal Tempomat on faulty.	Auxiliary operation.
4.1.24	Hand brake switch faulty.	Hand brake automatic mode not working.
4.1.25	Joystick F-R quick reverse signal faulty.	Auxiliary operation.
4.1.26	Joystick signal accelerator mode faulty.	Accelerator mode not working.
4.1.27	Armrest signal rapid reversal (F/R rocker) faulty.	Rapid reverse not working.
4.1.28	Track width adjustment faulty.	Auxiliary operation.
4.1.29	Joystick park position signal faulty.	Auxiliary operation.
4.1.2A	Bevel pinion rpm sensor direction signal faulty.	Auxiliary operation.
4.1.2B	Driving mode I/II selection button faulty.	Tractor remains in current driving mode. No further selection until ignition ON/OFF.
4.1.2C	'Neutral selection' button faulty.	Auxiliary operation.
4.1.2D	Quick Reverse button (steering column) faulty.	Quick Reverse only available with the joystick.
4.1.2E	Joystick key 'v+' faulty.	Auxiliary operation.
4.1.2F	Joystick v- faulty.	Auxiliary operation.
4.1.31	Direction signal speed sensor for hydrostatic unit faulty.	Auxiliary operation.
4.1.32	Joystick activating button faulty.	Auxiliary operation.
4.1.42	Speed sensor hydrostatic unit faulty.	Auxiliary operation.

FAULTS AND REMEDIAL ACTIONS

Fault code	Cause	Effect and remedy
4.1.44	Speed sensor engine 1 faulty.	Auxiliary operation.
4.1.45	Bevel pinion speed sensor faulty.	Auxiliary operation.
4.1.50	Transmission oil filter dirty.	Auxiliary operation.
4.1.53	Transmission oil temperature over 110°.	Damage to traction drive.
4.1.58	Slip values of transmission ratios beyond acceptable limits.	Occasional occurrences in extreme conditions have no effect. If the problem persists in normal conditions, contact the workshop immediately.
4.1.59	Emergency operation manually induced or by electrical activation; emergency operation defective when operated non-manually.	Fault code not in the memory.
4.1.61	Faulty activation of operating range I valve.	Auxiliary operation.
4.1.62	Faulty activation of operating range II valve.	Auxiliary operation.
4.1.63	Faulty activation of valve for mechanical speed limitation.	Max. speed 30 km/h only.
4.1.64	Faulty actuation of turboclutch valve.	Auxiliary operation.
4.1.65	Faulty activation of cardan brake.	Call workshop.
4.1.66	Faulty activation of cardan brake.	Call workshop.
4.1.67	Faulty activation of cardan brake.	Call workshop.
4.1.70	Tempomat cruise control 1 key faulty.	No Tempomat cruise control.
4.1.71	Tempomat cruise control 2 key faulty.	No Tempomat cruise control.
4.1.72	Filter contamination switch defective.	No monitoring of filter contamination.
4.1.73	Temperature output sensor faulty.	No temperature output monitoring.
4.1.74	Parking brake position recognition switch faulty.	Hand brake position not detected, no hand brake automatic mode.
4.1.76	Engine brake switch faulty.	No engine brake function.
4.1.77	Joystick acceleration rate I-IV faulty.	Operation only possible in acceleration rate III.
4.1.78	Starting cut-out seat switch for accelerator mode faulty.	Selection of direction of travel is always deactivated in accelerator mode when vehicle stationary for 3 seconds.
4.1.82	Plausibility error (engine speed) between hydrostatic unit speed sensor and bevel pinion speed sensor.	Auxiliary operation.
4.1.83	Plausibility error (direction) between hydrostatic unit speed sensor and bevel pinion speed sensor.	Auxiliary operation.
4.1.84	Plausibility error between the joystick controls (F/R, Tempomat cruise control).	Auxiliary operation.
4.1.85	Engine speed sensor I plausibility error.	Auxiliary operation.

FAULTS AND REMEDIAL ACTIONS

Fault code	Cause	Effect and remedy
4.1.86	Plausibility error between pressure sensor I and pressure sensor II.	Reduced comfort.
4.1.87	Plausibility error on F/R button on steering column.	No F/R function on steering column.
4.1.88	Plausibility error on ON/OFF button for accelerator pedal drive.	No function.
4.1.94	CAN communication E-Box and joystick faulty.	Joystick functions restricted. Call workshop.

Transmission

Fault code	Cause	Effect and remedy
4.1.A0	Adjuster actuation faulty.	Auxiliary operation.
4.1.A1	Control unit mechanical stop defective.	Auxiliary operation.
4.1.A2	Faulty CAN bus connection to control unit.	Auxiliary operation.
4.1.A3	Control unit incremental sensor faulty / not plausible.	Auxiliary operation.
4.1.A4	Adjuster EST track signal faulty/missing.	Auxiliary operation.
4.1.A5	Adjuster reference not found.	Auxiliary operation.
4.1.A6	Incorrect control unit reference point during operation.	Auxiliary operation.
4.1.B0	Initialisation error on communication driver. CAN bus communication restricted.	Restricted operation.
4.1.B1	Fatal error range control with subsequent emergency operation (e.g. valve fault).	Auxiliary operation.
4.1.B2	Transmission ratio limiting faulty.	EOL programming.
4.1.B3	Quick Reverse acceleration rate parameters out of tolerance.	EOL programming.
4.1.B4	Engine speed sensor I plausibility error.	EOL programming.
4.1.B5	Rapid reversing ramp parameter for Tractor Management System (TMS) checksum error.	Rapid reversing not operational in the Tractor Management System (TMS).
4.1.E0	Turboclutch characteristic faulty/incorrectly memorised.	EOL programming.
4.1.E1	Traction control pressure regulator parameter fault/read error.	EOL programming.
4.1.E2	Pressure regulator parameters in traction control are not plausible or read in incorrectly.	No traction control function.
4.1.E3	Accelerator checksum error.	EOL programming.
4.1.E4	Brake control checksum error.	EOL programming.
4.1.E9	Values of operating range shift II-I not within tolerance.	Only shift while at a standstill.
4.1.EA	Incorrect EOL programming.	Auxiliary operation.
4.1.EB	Range-change values out of tolerance or range-change not calibrated.	Auxiliary operation.

FAULTS AND REMEDIAL ACTIONS

Fault code	Cause	Effect and remedy
4.1.EC	Accelerator rotary control values not within tolerances or no calibration of accelerator rotary control.	Auxiliary operation.
4.1.ED	Clutch pedal potentiometer values out of tolerance or clutch not calibrated.	Auxiliary operation.
4.1.EE	Transmission characteristic values out of tolerance or no calibration of transmission.	Auxiliary operation.
4.1.EF	Turboclutch values out of tolerance or no calibration.	Auxiliary operation.
4.1.FF	Error in transmission EST control unit.	Auxiliary operation.

Four-wheel drive and differential lock

Fault code	Cause	Effect and remedy
5.1.31	100% 4-WD button faulty.	'4-WD automatic mode' available only.
5.1.32	Key for automatic 4WD faulty.	'100% 4-WD' available only.
5.1.33	Faulty 4-WD clutch solenoid valve.	Function terminated, 4-WD engages.
5.1.34	Steering angle sensor 1 faulty.	4-WD / differential lock automatic mode Stop not functioning.
5.1.35	Steering angle sensor 2 faulty.	4-WD / differential lock automatic mode Stop not functioning.
5.1.51	100% differential lock button faulty.	Only 'Differential lock automatic mode' function available.
5.1.52	Key for automatic differential lock faulty.	'100% differential lock' is only function still available.
5.1.53	Differential lock solenoid actuation faulty.	End of function, differential lock not disengaging.
5.1.54	Left brake pedal switch faulty.	'100% differential lock' is only function still available.
5.1.55	Right brake pedal switch faulty.	'100% differential lock' is only function still available.

Suspension

Fault code	Cause	Effect and remedy
5.1.61	Front axle suspension position sensor faulty.	Front axle suspension does not function. Possible to continue without suspension.
5.1.62	Front axle suspension "Raise" solenoid actuation faulty.	Front axle suspension does not function. Possible to continue without suspension.
5.1.63	Incorrect activation of solenoid valve 'lower' for front axle suspension.	Front axle suspension does not function. Possible to continue without suspension.
5.1.64	Front axle suspension on/off key defective.	Front axle suspension does not function. Possible to continue without suspension.
5.1.65	Lock front axle suspension key faulty.	Locking of front axle suspension no longer possible.
5.1.6 E	No calibration of position sensor.	Front axle suspension does not function. Readjust position sensor.

FAULTS AND REMEDIAL ACTIONS

Power lift and PTO automatic mode

Fault code	Cause	Effect and remedy
5.1.91	Joystick rear automatic mode on/off button faulty.	Rear automatic mode not working.
5.1.93	Joystick front automatic mode on/off button faulty.	Front automatic mode not functioning.
5.1.95	Joystick automatic mode stop button faulty.	Automatic mode cannot be switched on and off.

Hydraulic system (push button / flow controller)

Fault code	Cause	Effect and remedy
5.1.98	Control pump oil pressure monitoring faulty.	Possible failure of work hydraulics.
5.1.99	Signal of flow control sensor disturbed or no oil pressure on the auxiliary pump.	Possible failure of auxiliary pump (constant displacement pump).

Other fault codes

Fault code	Cause	Effect and remedy
5.1.00	Control unit fault.	E-Box faulty.
5.1.8D	Checksum error. Old automatic mode configuration data.	Reduced comfort.
5.1.8F	Checksum error. Old automatic function sequential data.	Reduced comfort.
5.1.9A	Plausibility check error on flow controller with ignition ON and engine OFF.	No pressure monitoring.
5.1.9B	8 bar pressure switch faulty.	No pressure monitoring.
5.1.B0	Initialisation error on communication driver. CAN bus communication restricted.	EOL programming.
5.1.9E	Engine coolant level too low or empty.	Risk of engine damage. Once the warning has been confirmed, the error message is output every 120 sec. if the coolant has not been topped up.
5.1.9F	Engine coolant level sensor defective.	No coolant level monitoring.
5.1.FF	Comfort E-box no longer receiving CAN data for engine speed and PTO speed.	Various indicators no longer available or comfort E-box fails completely.

Rear PTO

Fault code	Cause	Effect and remedy
6.1.01	Button in cab faulty.	Does not function, PTO disengages.
6.1.02	Key on right mudguard faulty.	PTO can only be switched on/off with the cab button. Button must be pressed for at least 5 secs.
6.1.03	Button on left mudguard faulty.	PTO can only be switched on/off with the cab button. Button must be pressed for at least 5 secs.
6.1.04	PTO shaft clutch solenoid valve faulty.	Does not function, PTO disengages.

FAULTS AND REMEDIAL ACTIONS

Fault code	Cause	Effect and remedy
6.1.05	PTO shaft rpm sensor faulty.	PTO can only be switched on/off with the cab button. Button must be pressed for at least 5 secs.
6.1.10	Speed sensor shaft faulty.	
6.1.11	Automatic mode on operating console faulty.	Automatic mode is ended and PTO disengages.
6.1.15	Neutral speed selection key faulty.	Does not function, PTO disengages.
6.1.16	Selection range key 540 faulty.	No function of range selection key 540.
6.1.17	Setting 540E selection button faulty.	Setting 540E selection button does not function.
6.1.18	Speed selection key 1000 faulty.	No function of speed selection key 1000.
6.1.1A	Setting 540 valve faulty.	Does not function, PTO disengages.
6.1.1B	Control valve 540E faulty.	Does not function, PTO disengages.
6.1.1C	Control valve 1000 faulty.	Does not function, PTO disengages.
6.1.41	Cab button plausibility error.	Does not function, PTO disengages.
6.1.42	Right mudguard button plausibility error.	Does not function, PTO disengages.
6.1.43	Left mudguard button plausibility error.	Does not function, PTO disengages.
6.1.45	PTO clutch rpm sensor plausibility error.	PTO can only be operated via keys inside the cab, key must be kept pressed for at least 5 secs.
6.1.50	Speed sensor PTO shaft plausibility error.	When engaging, the button must be pressed for at least 5 secs.
6.1.55	Plausibility error in speed selection key neutral.	Does not function, PTO disengages.
6.1.56	Plausibility error in speed selector key 540.	No function of 540 selection.
6.1.57	540E setting pre-selection button plausibility error.	No function of 540E selection.
6.1.58	Plausibility error in speed selection key 1000.	No function of 1000 selection.
6.1.60	Plausibility error between PTO clutch rpm and PTO stub shaft speed.	Does not function, PTO disengages.
6.1.BO	Initialisation error on communication driver. CAN bus communication restricted.	EOL programming.
6.1.C1	Switch-on speed not reached for PTO/power lift automatic mode.	Increase ground speed to more than 1 km/h.
6.1.E0	Checksum parameter current control for range shifting faulty.	EOL programming.
6.1.E1	Checksum PTO parameter faulty.	EOL programming.

FAULTS AND REMEDIAL ACTIONS

Front PTO

Fault code	Cause	Effect and remedy
7.1.01	PTO key inside the cab faulty.	Does not function, PTO disengages.
7.1.04	Clutch operation solenoid faulty.	
7.1.05	PTO shaft rpm sensor faulty.	To engage, the button must be pressed for at least 5 sec.
7.1.09	Automatic front PTO key on operating console defective.	Automatic mode is ended and PTO disengages.
7.1.41	Cab button plausibility error.	Does not function, PTO disengages.
7.1.C1	Switch-on speed not reached for PTO/power lift automatic mode.	Increase ground speed to more than 1 km/h.

EPC-C rear power lift

Fault code	Cause	Effect and remedy
8.3.11	Lift final stage defective.	Control is terminated and locked.
8.3.12	Lower final stage defective.	Control is terminated and locked.
8.3.14	Rear left 'Lift'key is defective.	Control is terminated and locked.
8.3.15	Left rear "Lower" button faulty.	Control is terminated and locked.
8.3.16	V regulator less than 1 Volt.	Control is terminated and locked.
8.3.17	Battery voltage over 18 V.	Control is terminated and locked.
8.3.18	Rear right 'Lift' key is defective.	Control is terminated and locked.
8.3.19	Rear right 'Lower' key is defective.	Control is terminated and locked.
8.3.22	Position sensor defective.	Control is terminated and locked.
8.3.23	Setpoint rotary control defective.	Control is terminated and locked.
8.3.26	Faulty external sensor.	Control is terminated and locked.
8.3.31	Right draught sensing pin defective.	Control is continued
8.3.32	Left load sensor pin faulty.	Control is continued
8.3.33	Battery voltage less than 10.5 V.	Control is continued
8.3.40	Quick Lift switch faulty.	Raise and Lower only possible with the rear controls.
8.3.41	Fast feed-in button faulty.	Fast feed-in does not function.
8.3.42	Hitch button faulty.	Hitch key not functioning.
8.3.43	Automatic rear lifting gear key (control console) defective.	Automatic rear lifting gear key not operational.
8.3.50	Warning, right load sensor pin overloaded.	Warning is not stored. Relieve drafting sensing pin of load.
8.3.51	Warning, left load sensor pin overloaded.	Warning is not stored. Relieve drafting sensing pin of load.

Front power lift

Fault code	Cause	Effect and remedy
9.1.50	Valve not registered on CAN-bus.	Valve actuation not possible.
9.1.5F	Incorrect messages sent on CAN bus. Electronics in valve faulty.	Valve goes into neutral position.
9.1.51	Electronics in valve faulty.	Valve goes into neutral position. Replace valve.

FAULTS AND REMEDIAL ACTIONS

Fault code	Cause	Effect and remedy
9.1.52	Voltage in the valve less than 8 V.	Valve goes into neutral position.
9.1.53	Voltage in excess of 18 V.	Valve goes into neutral position.
9.1.54	Valve actuator falls short. Drops in control pressure or oil too viscous at low temperatures.	Valve goes into neutral position.
9.1.5A	Valve actuator goes too far.	Valve goes into neutral position.
9.1.5B	Floating position not reached.	Valve goes into neutral position.
9.1.5C	Manual actuation.	None.
9.1.55	High overvoltage over 45 V.	Valve goes into neutral position.
9.1.56	Final stage error (pilot control solenoid valve).	Valve goes into neutral position.
9.1.57	Position pickup sensor error.	Valve goes into neutral position.
9.1.58	Valve actuator does not return.	Valve slide jams.
9.1.59	Slide valve jams because of dirt.	Valve slide jams.
9.1.A0	No memorised values after engine re-start.	Reduced driving comfort.
9.1.A1		
9.1.B0	Position sensor is not calibrated.	No position control possible.
9.1.B1	Position sensor transmits no values or wrong values.	No position control possible.
9.1.B2	Set point rotary control not calibrated.	Setpoint values cannot be set.
9.1.B3	Setpoint potentiometer sends no values or incorrect values.	Setpoint values cannot be set.
9.1.C0	Operating console not available.	No automatic mode, no general locking.
9.1.C1	Automatic mode button faulty.	No automatic mode.
9.1.C2	Overall locking key faulty.	No overall locking of valves.
9.1.C3	Floating position button faulty.	No floating position.
9.1.C4	Front power lift Raise button faulty.	Front power lift cannot be raised properly.
9.1.C5	Front power lift 'Lower' faulty.	Front power lift cannot be lowered properly.
9.1.C6	Possible fault on CAN bus to operating console.	Status changes cannot be detected. Engagement/disengagement possibly being overridden.
9.1.C7		
9.1.C8		
9.1.C9		
9.1.CA		
9.1.D0	External Lift key faulty.	Front power lift cannot be lowered properly.
9.1.D1	External Lower key faulty.	Front power lift cannot be lowered properly.
9.1.D2	External key actuates twice or key sticks.	Front power lift cannot be lowered properly.

FAULTS AND REMEDIAL ACTIONS

Electric valves (operating console)

Fault code	Cause	Effect and remedy
A.1.C0	Control console not available, e.g. CAN-bus not connected.	No automatic mode. No general locking of valves.
A.1.C1	Automatic mode button faulty.	No automatic mode.
A.1.C2	Overall locking key faulty.	No overall locking of valves.
A.1.C3	Floating position button faulty.	No floating position.
A.1.C4	Timer function button faulty.	No timer function.
A.1.C5	Crossgate lever/joystick switch-over button faulty.	Not possible to switch between crossgate lever operation and joystick operation.
A.1.C6	Operating console CAN bus faulty.	Change of status not detected. Switching on/off is ignored. Valve locked.
A.1.C7		
A.1.C8		
A.1.C9		
A.1.CA		
A.1.CB	CAN joystick not available.	Not possible to operate valves.
A.1.CC	E-Box and CAN joystick CAN connection faulty.	Limited operation of valves.

Electric valves (crossgate lever)

Fault code	Cause	Effect and remedy
A.1.B0	Crossgate lever not adjusted.	Valves cannot be actuated. Carry out adjustment.
A.1.B1	Signal fault.	Valve position cannot be controlled properly.
A.1.B2		
A.1.B3		
A.1.B4		
A.1.B5	Crossgate lever recognition of centre position faulty.	Valve position cannot be operated accurately. Calibrate.

Electric valves (buttons / switches)

Fault code	Cause	Effect and remedy
A.1.FA	External valve actuation. Spool valve external pushbutton for rear LIFT faulty.	Rear external controls not working.
A.1.FB	External valve actuation. Spool valve external pushbutton for rear LOWER faulty.	Rear external controls not working.
A.1.FC	External valve actuation. Spool valve external pushbutton rear actuates twice or pushbutton is faulty.	Change controls or exchange keys.
A.1.D1	Valve 3, signal disturbed or faulty valve.	'Lift' and/or 'Lower' valve 3 faulty.
A.1.D3	Valve 4, signal disturbed or faulty valve.	'Lift' and/or 'Lower' valve 4 faulty.
A.1.D4	Faulty solenoid switch for release of external controls of standard front power lift.	Position of shutoff cock for front power lift cannot be detected.
A.1.D5	External front power lift 'Lower' button faulty.	Front power lift cannot be lowered properly.

FAULTS AND REMEDIAL ACTIONS

Fault code	Cause	Effect and remedy
A.1.D6	External front power lift 'Raise' button faulty.	Front power lift cannot be raised properly.
A.1.D7	Hydraulic oil level sensor faulty.	Hydraulic oil level no longer monitored.
A.1.D9	Hydraulic tank is empty.	Possible damage to pump or undesired valve responses.
A.1.DA	Kickout push button faulty.	No Kickout function.
A.1.DB	Hydraulic oil characteristic not plausible.	Incorrect display of hydraulic oil supply. Reprogramme EOL.
A.1.DC	Priority volume of hydraulic oil greater than pump volume.	Reduce priority hydraulic oil quantity.
A.1.DD	Front external key actuates twice or key sticks.	Front power lift cannot be lowered properly.

Electrical valves (valve 1)

Fault code	Cause	Effect and remedy
A.1.10	Valve not registered on CAN bus.	Valve actuation not possible.
A.1.1F	CAN-BUS error, valves.	Valves locked.
A.1.11	Electronics in valve faulty.	Valve goes into neutral position.
A.1.12	Voltage in the valve less than 8 Volt.	Valve goes into neutral position.
A.1.13	Voltage in excess of 18 V.	Valve goes into neutral position.
A.1.14	Valve actuator falls short.	Valve goes into neutral position.
A.1.1A	Valve actuator goes too far.	Valve goes into neutral position.
A.1.1B	Floating position not reached.	Valve goes into neutral position.
A.1.1C	Manual actuation.	
A.1.15	High overvoltage over 45 V.	Valve goes into neutral position.
A.1.16	End stage error (end stage for pilot control solenoid).	Valve goes into neutral position.
A.1.17	Position pickup sensor error.	Valve goes into neutral position.
A.1.18	Valve actuator does not return to neutral position.	Valve remains set.
A.1.19	Valve actuator not in neutral position when switched on.	Valve remains set.

FAULTS AND REMEDIAL ACTIONS

Spool valves (valve 2)

Fault code	Cause	Effect and remedy
A.1.20	Valve not registered on CAN bus.	Valve actuation not possible.
A.1.2F	CAN-BUS error, valves.	Valves locked.
A.1.21	Electronics in valve faulty.	Valve goes into neutral position.
A.1.22	Voltage in the valve less than 8 Volt.	Valve goes into neutral position.
A.1.23	Voltage in excess of 18 V.	Valve goes into neutral position.
A.1.24	Valve actuator falls short.	Valve goes into neutral position.
A.1.2A	Valve actuator goes too far.	Valve goes into neutral position.
A.1.2B	Floating position not reached.	Valve goes into neutral position.
A.1.2C	Manual actuation.	
A.1.25	High overvoltage over 45 V.	Valve goes into neutral position.
A.1.26	End stage error (end stage for pilot control solenoid).	Valve goes into neutral position.
A.1.27	Position pickup sensor error.	Valve goes into neutral position.
A.1.28	Valve actuator does not return to neutral position.	Valve remains set.
A.1.29	Valve actuator not in neutral position when switched on.	Valve remains set.

Spool valves (valve 3)

Fault code	Cause	Effect and remedy
A.1.30	Valve not registered on CAN bus.	Valve actuation not possible.
A.1.3F	Valve CAN BUS error.	Valves locked.
A.1.31	Electronics in valve faulty.	Valve goes into neutral position.
A.1.32	Voltage in the valve less than 8 Volt.	Valve goes into neutral position.
A.1.33	Voltage in excess of 18 V.	Valve goes into neutral position.
A.1.34	Valve actuator falls short.	Valve goes into neutral position.
A.1.3A	Valve actuator goes too far.	Valve goes into neutral position.
A.1.3B	Floating position not reached.	Valve goes into neutral position.
A.1.3C	Manual actuation.	
A.1.35	High overvoltage over 45 V.	Valve goes into neutral position.
A.1.36	End stage error (end stage for pilot control solenoid).	Valve goes into neutral position.
A.1.37	Position pickup sensor error.	Valve goes into neutral position.
A.1.38	Valve actuator does not return to neutral position.	Valve remains set.
A.1.39	Valve actuator not in neutral position when switched on.	Valve remains set.

FAULTS AND REMEDIAL ACTIONS

Spool valves (valve 4)

Fault code	Cause	Effect and remedy
A.1.40	Valve not registered on the CAN bus.	Valve actuation not possible.
A.1.4F	CAN-BUS error, valves.	Valves locked.
A.1.41	Electronics in valve faulty.	Valve goes into neutral position.
A.1.42	Voltage in the valve less than 8 Volt.	Valve goes into neutral position.
A.1.43	Voltage in excess of 18 V.	Valve goes into neutral position.
A.1.44	Valve actuator falls short.	Valve goes into neutral position.
A.1.4A	Valve actuator goes too far.	Valve goes into neutral position.
A.1.4B	Floating position not reached.	Valve goes into neutral position.
A.1.4C	Manual actuation.	
A.1.45	High overvoltage over 45 V.	Valve goes into neutral position.
A.1.46	End stage error (end stage for pilot control solenoid).	Valve goes into neutral position.
A.1.47	Position pickup sensor error.	Valve goes into neutral position.
A.1.48	Valve actuator does not return to neutral position.	Valve remains set.
A.1.49	Valve actuator not in neutral position when switched on.	Valve remains set.

Electric valves (E-box)

Fault code	Cause	Effect and remedy
A.1.A0	EEPROM error.	Loss of enhanced features when operating valves.
A.1.A1		
A.1.A2	More valves connected than are registered through end-of-line programming. Undertake programming.	Not all valves can be operated.
A.1.FO	Valve control for the switching of the pilot control of all electrical valves with front power lift faulty.	All valves go into neutral position.
A.1.F1	Valve control for the heating of all electrical valves with front power lift faulty.	Reduced operation in cold conditions.
A.1.F2	Valve control for switching the pilot control of all spool valves with front power lift faulty.	Call workshop.
A.1.F3	Valve control for switching the pilot control of all spool valves with front power lift has interrupted supply line.	Call workshop.

FAULTS AND REMEDIAL ACTIONS

Variotronic Ti

Fault code	Cause	Effect and remedy
B.1.11	Electrical fault, automatic mode.	Call workshop.
B.1.12	Electrical fault, terminal.	Call workshop.
B.1.21	Communications error, internal communication.	Call workshop.
B.1.22	Communications error between terminal and Variotronic Ti.	Call workshop.
B.1.23	Communications error between control console and Variotronic Ti.	Call workshop.
B.1.24	Communications error between joystick and Variotronic Ti.	Call workshop.
B.1.41	Communications error, internal communication.	Call workshop.
B.1.42	Communications error between terminal and Variotronic Ti.	Call workshop.
B.1.43	Communications error between control console and Variotronic Ti.	Call workshop.
B.1.44	Error counter between joystick and Variotronic Ti.	Call workshop.
B.1.BO	Error reader Variotronic Ti.	Call workshop.
B.1.B4	Error in the memory function.	Restart tractor. If error is still there, consult workshop.

6. Emergency operation



DANGER:

Turn off the engine, put the driving mode selector in neutral position (centre position) and apply the hand brake.



CAUTION:

After starting the engine, the transmission is fully engaged if a driving mode (I or II) has been selected. Since either a transmission ratio or a direction of travel is selected, the clutch pedal must be operated carefully.

If the transmission ratio can no longer be set by the electronic system due to actual or indicated faults, the transmission can be controlled mechanically with the auxiliary lever.

The maximum speed in range 2 is 34 km/h for forward travel and 25 km/h for reverse, in range 1 the maximum speed for forward travel is 15 km/h and 11 km/h for reverse.



Fig.6

- Open cover from the cab floor and remove.
- Connect auxiliary lever (A) to transmission adjustment.

Auxiliary lever is included as standard equipment.

Activating the emergency operation

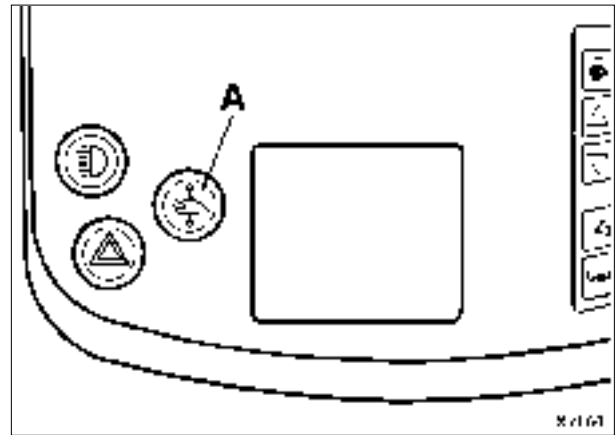

Fig.7

- Press clutch pedal.
- Press button (A/red).

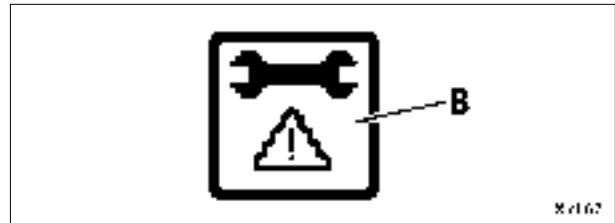

Fig.8

Symbol (B) is now shown on the multiple display.

Symbol (B) is also displayed in the event of a fault leading to emergency operation.

When using emergency operation, travel direction indicators are no longer active.

If activated unintentionally:

- Stop the tractor.
- Terminate emergency operation by switching ignition OFF and ON.

Mechanical selection of transmission ratio

IMPORTANT:

When setting the transmission ratio, only the supplied auxiliary lever should be used, otherwise the coupling in the adjuster may be turned too far (max. perm. torque 10 Nm).

- Carefully engage clutch pedal.

The tractor starts moving into the last selected travel direction and accelerates up to the selected transmission ratio.

FAULTS AND REMEDIAL ACTIONS

Auxiliary lever

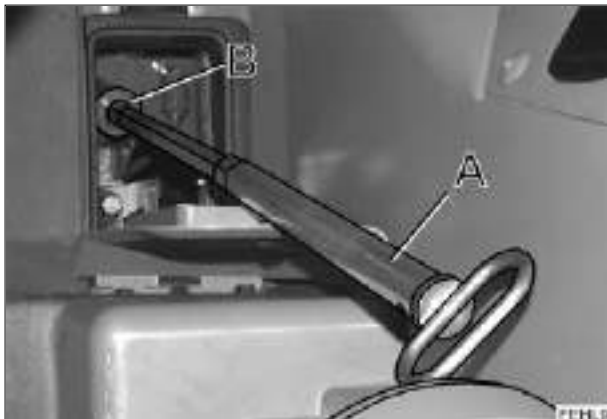

Fig.9

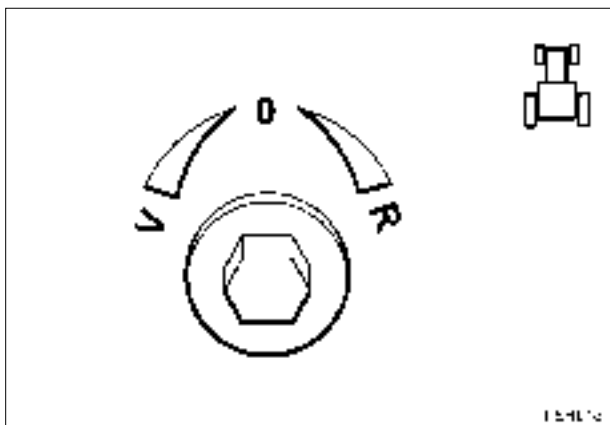

Fig.10

- If the auxiliary lever (A) is moved to the left during forwards travel, the tractor accelerates. If the auxiliary lever is moved to the right, the tractor slows down because it is braked.
- If the auxiliary lever is moved to the right while reversing, the tractor accelerates. If the auxiliary lever is moved to the left, the tractor is braked and slows down.

Driving mode selector

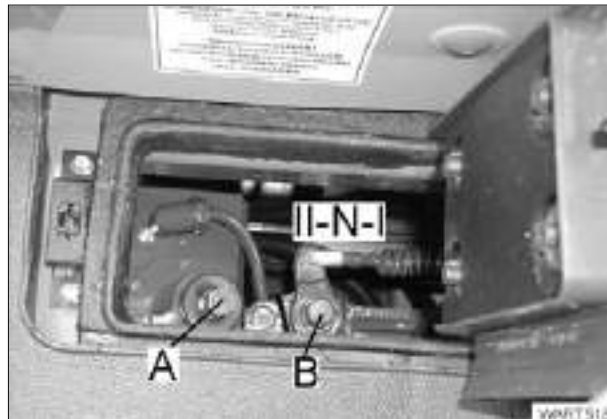

Fig.11

- Attach auxiliary device to range control switch (B).
- Operate the clutch pedal.

NOTE:

An extension can be used as an aid for selecting the driving mode.

The max. travel speed for any range selection is 2 km/h.

Selector directions:

- Right = Range I (field).
- Centre = Neutral position N (neutral).
- Left = Driving mode II (road).

Terminating emergency operation

- Stop the tractor.
- Terminate emergency operation by switching ignition OFF and ON.

1. Technical data

Model		916	920
Engine			
Engine type		DO836LE508	DO836LE507
Turbocharger / intercooler		with / with	with / with
No. of cylinders / cooling		6 / water	6 / water
Bore / stroke	mm	108 / 125	108 / 125
Effective displacement	l	6,870	6,870
Idling speed	rpm	730 ±30	730 ±30
Rated speed	rpm	2150	2150
Engine speed without load	rpm	2450-2500	2450-2500
Fuel	l	530	530
Engine switch-off		electrical	electrical
Noise level at driver's ear	dB(A)	72	72
Engine alignment			
Ensure vehicle stability			
Lengthwise in travel direction high / low	degree	25	25
Across travel direction left / right	degree	25	25
Dimensions and weights			
with the following tyres and track width			
Tyres front		480/70 R34	480/70 R34
Tyres rear		580/70R42	580/70R42
Track width front	mm	2000	2000
Track width, rear	mm	1970	1970
Overall length	mm	4940	4940
Overall width	mm	2550	2550
Total height	mm	3095	3095
Ground clearance	mm	605	605
Wheelbase	mm	2840	2840
Flange size front	mm	1892	1892
Flange size rear	mm	1890	1890
Min. track circle radius without / with steering clutch brake	mm	5,9/5,4	5,9/5,4
Unloaded weight	kg	8750	8750
Max. permissible gross weight 50 km/h	kg	12000	12000
Max. permissible gross weight with implement, depending on tyres	kg	14000	14000
Max. permissible front axle load	kg	6450	6450
Max. permissible rear axle load	kg	8500	8500
Max. vertical bearing load on trailer hitch	kg	2000	2000
Permissible vertical bearing load on trailer hitch	kg	3000	3000
Rear PTOs 540/540E/1000			
PTO shaft profile		1 3/4 6-part	1 3/4 6-part
PTO speed at rated engine speed and 540 setting	rpm	596	596
PTO speed at rated engine speed and 540E setting	rpm	760	760
PTO speed at rated speed and 1000 setting	rpm	1108	1108
PTO speed at rated engine speed in setting 750	Nm	3500	3500
Max. permissible torque for 540E setting	Nm	2100	2100
PTO speed when rated engine speed is selected for 1000	Nm	1600	1600
Front PTO 1000			
PTO speed at nominal speed 1000 version	rpm	1111	1111
PTO speed when rated engine speed is selected for 1000	Nm	830	830
Hydraulics			
Working pressure	bar	200	200
Hydraulic pump	l	112	112
Hydr. oil extraction flow at max. capacity	l	65	65

TECHNICAL DATA

Model		916	920
Rear power lift Three-point Control		cat. 2/3 EPC	cat. 2/3 EPC
Maximum lifting power at drawbar	kN	95,5	95,5
Front power lift (optional) Three-point		Cat. 2	Cat. 2
Max. lifting power	kN	50,0	50,0
Weight of implement at coupling point	kg	3600	3600
Transmission			
Continuously variable Vario transmission	km/h	50	50
Range I forwards	km/h	0,02 - 32	0,02 - 32
Driving mode I reverse	km/h	0,02 - 20	0,02 - 20
Driving mode II forwards	km/h	0,02 - 50	0,02 - 50
Driving mode II reverse	km/h	0,02 - 38	0,02 - 38
Electrical system			
Operating tension	V	12	12
Battery	V/Ah	2x 12/90	2x 12/90
Alternator	W/V/A	2520/14/2x90	2520/14/2x90
Starter	kW	4,0	4,0
Tightening torques for wheels (threads and contact surfaces lightly oiled)			
Front wheels	Nm	450	450
Rear wheels	Nm	620	620

TECHNICAL DATA

Model		924	926	930
Engine				
Engine type		DO836LE506	DO836LE505	DO836LE510
Turbocharger / intercooler		with / with	with / with	with / with
No. of cylinders / cooling		6 / water	6 / water	6 / water
Bore / stroke	mm	108 / 125	108 / 125	108 / 125
Effective displacement	l	6,870	6,870	6,870
Idling speed	rpm	810 ±30	810 ±30	810 ±30
Rated speed	rpm	2250	2250	2250
Engine speed without load	rpm	2510-2550	2510-2550	2510-2550
Fuel	l	530	530	530
Engine switch-off		electrical	electrical	electrical
Noise level at driver's ear	dB(A)	72	72	72
Engine alignment				
Ensure vehicle stability				
Lengthwise in travel direction high / low	degree	25	25	25
Across travel direction left / right	degree	25	25	25
Dimensions and weights				
with the following tyres and track width				
Tyres front		540/65 R34	600/65 R34	600/65 R34
Tyres rear		650/65R42	650/85R38	710/70R42
Track width front	mm	2000	2000	2000
Track width, rear	mm	1970	1970	1970
Overall length	mm	4940	4940	4940
Overall width	mm	2580	2640	2700
Total height	mm	3110	3110	3110
Ground clearance	mm	605	605	605
Wheelbase	mm	2840	2840	2840
Flange size front	mm	1892	1892	1892
Flange size rear	mm	1890	1890	1890
Min. track circle radius without / with steering				
clutch brake	mm	5,9/5,4	5,9/5,4	5,9/5,4
Unloaded weight	kg	8800	8800	8950
Max. permissible gross weight 50 km/h	kg	12000	12000	12000
Max. permissible gross weight with implement, depending on tyres	kg	14000	14000	14000
Max. permissible front axle load	kg	5450	6000	6000
Max. permissible rear axle load	kg	8500	8500	9500
Max. vertical bearing load on trailer hitch	kg	2000	2000	2000
Permissible vertical bearing load on trailer hitch	kg	3000	3000	3000
Rear PTOs 540/540E/1000				
PTO shaft profile		1 3/4 6-part	1 3/4 6-part	1 3/4 6-part
PTO speed at rated engine speed and 540 setting	rpm	596	596	596
PTO speed at rated engine speed and 540E setting	rpm	760	760	760
PTO speed at rated speed and 1000 setting	rpm	1108	1108	1108
PTO speed at rated engine speed in setting 750	Nm	3500	3500	3500
Max. permissible torque for 540E setting	Nm	2100	2100	2100
PTO speed when rated engine speed is selected for 1000	Nm	1600	1600	1600
Front PTO 1000				
PTO speed at nominal speed 1000 version	rpm	1111	1111	1111
PTO speed when rated engine speed is selected for 1000	Nm	830	830	830

TECHNICAL DATA

Model		924	926	930
Hydraulics				
Working pressure	bar	200	200	200
Hydraulic pump	l	117	117	117
Hydr. oil extraction flow at max. capacity	l	65	65	65
Rear power lift				
Three-point		cat. 2/3	cat. 2/3	cat. 2/3
Control		EPC	EPC	EPC
Maximum lifting power at drawbar	kN	108,5	108,5	108,5
Front power lift (optional)				
Three-point		Cat. 2	Cat. 2	Cat. 2
Max. lifting power	kN	50,0	50,0	50,0
Weight of implement at coupling point	kg	3600	3600	3600
Transmission				
Continuously variable Vario transmission	km/h	50	50	50
Range I forwards	km/h	0,02 - 32	0,02 - 32	0,02 - 32
Driving mode I reverse	km/h	0,02 - 20	0,02 - 20	0,02 - 20
Driving mode II forwards	km/h	0,02 - 50	0,02 - 50	0,02 - 50
Driving mode II reverse	km/h	0,02 - 38	0,02 - 38	0,02 - 38
Electrical system				
Operating tension	V	12	12	12
Battery	V/Ah	2x 12/90	2x 12/90	2x 12/90
Alternator	W/V/A	2520/14/2x90	2520/14/2x90	2520/14/2x90
Starter	kW	4,0	4,0	4,0
Tightening torques for wheels (threads and contact surfaces lightly oiled)				
Front wheels	Nm	450	450	450
Rear wheels	Nm	620	620	620

NOTE:

Any modifications to the power output limiter and max. speed setting shall render the Warranty invalid. This also applies to any exceeding of the maximum permissible loads and weights.

NOTE:

For PTO mode:

If the maximum permissible torque can be exceeded (depending on the application), use a drive shaft with safety coupling and overrunning clutch if necessary.

Maximum failsafe mechanism to prevent blocking at peaks in torque of 4000 Nm.

2. Tyre pressures



CAUTION:
Check tyre pressures regularly!

Tyre pressure front

1.6 bar.

Tyre pressure rear

1.6 bar.

Comply with tyre manufacturer's recommendations.

- Pressures may differ according to tractor model, make of tyre and type of operation e.g. front loader operation.
- For max. traction and min. ground pressure in the field, adapt tyre pressures to axle load.
- According to German vehicle licensing regulations, if tyres bring the vehicle width to 2.5 m - 3.0 m (wide tyres), the maximum tyre pressure is 1.5 bar.
- Tyre load capacity is designated by a 'service description' with a load capacity identifier, e.g. 145 = 2,900 kg basic load capacity per tyre, and a speed symbol, e.g. A8 = 40 km/h reference speed.
- If 40 km/h tyre is used at 50 km/h, the basic load capacity is reduced by 9 %.
- Do not operate maintenance wheels above a maximum speed of 40 km/h.
- Increase the tyre pressure when operating the front loader.

3. Tyre combinations

Vario 916 - 920

916 - 920 Vorne: avant: anteriori: front:	Hinten/ arriere/ posteriori/ rear:												
	R008 580/70R42	R489 650/70R42	R090 650/65R42	R485	R419 650/70R38 1)	R091 650/65R38	R092	R094	R425 710/70R38	R422	R093 710/70R42	R094	R012 900/50R42 1)
	PI	EL	CO	MI	MI	KL	MI	MI	PI	KL	MI	PI	MI
R312 480/70R34 KL	+	+	+	+	+								
R313	+	+	+	+	+								
R343 520/70R34 KL						+	+	+			+	+	
R339						+	+	+			+	+	
R882 540/65R34 CO	+	+	+	+	+				+	+	+	+	
R881	+	+	+	+	+				+	+	+	+	
R883	+	+	+	+	+				+	+	+	+	
R885 600/65R34 KL						+	+	+			+	+	
R884						+	+	+			+	+	
R886						+	+	+			+	+	
R887						+	+	+			+	+	
R580 600/70R38 KL		+											+

Fig.1

1) Separate TÜV certification

Vario 924 - 930

924 - 930 Vorne: avant: anteriori: front:	Hinten/arriere/posteriori/rear:										
	R485 650/65R42	R890	R091 650/65R38	R094	R092	R422 710/70R38	R425	R424	R093 710/70R42	R094	R012 900/50R42 1)
	PI	CO	KL	MI	PI	KL	PI	MI	MI	PI	MI
R312 480/70R34 KL	+	+				+	+	+			
R313	+	+				+	+	+			
R343 520/70R34 KL			+	+	+				+	+	
R339			+	+	+				+	+	
R881 540/65R34 PI	+	+				+	+	+			
R882	+	+				+	+	+			
R883	+	+				+	+	+			
R885 600/65R34 KL			+	+	+				+	+	
R884			+	+	+				+	+	
R886			+	+	+				+	+	
R887			+	+	+				+	+	
R580 600/70R38 KL											+

Fig.2

1) Separate TÜV certification

4. Fuel and lubricants Vario 916 - 930

Filling points	Number approx. litres 1)	Type 4)	Frequency of change 2)
Engine Maximum fill, with change of filter	24.0	Fendt Extra Grade 15W-40 SHPD, Fendt Ultra Grade 10W-40 UHPD or SHPD engine oils 3) in accordance with ACEA E3-96.	after 50, 500, 1000 operating hours then every 500 hours of operation or a minimum of once every year, with fuel containing up to 0.5 % sulphur 5).
Transmission and differential (topping up) Vario 916-920 Vario 924-930 Lift shaft lubrication	65.0 67.0 0.2	Fendt Extra Trans 10W-40 or STOU SAE 10 W-40 or 15 W-40	every 2 years or after 2000 operating hours. Lifting shaft lubrication (just top up) after 50 operating hours or if leaking.
Axle drives per side Vario 916-920 Vario 924-930	13.0 16.0	Fendt Super Trans 85W-90, 80W or Hypoid transmission oil SAE 85W-90, SAE 80W-90, SAE 90 acc. to API GL-5.	every 500 operating hours then every 2 years. every 2000 op. hrs.
Front PTO	4.2	Do not use STOU or other universal oils.	
Front axle Differential drives Axle hub per side	9.5 4.0	Fendt Super Trans LS 85W-90 or hypoid transmission oil with LS additives. SAE 85W-90, SAE 80W-90, SAE 90 acc. to API GL-5 Do not use STOU or other universal oils.	after 50 and 1000 operating hours then every 2 years or every 1,000 op. hours
Rear axle shaft (optional) Axle drives per side	16.0	Hypoid transmission oil 85 W-140 in accordance with API GL-5.	after 500 operating hours, then every 2 years or 2000 operating hours
Hydraulic system Quantities Maximum capacity	70.0 100.0	Fendt Super Hyd, Fendt Extra Hyd 68 or STOU SAE 5W-30, 5W-40, 10W-30, 10W-40, 15W-30, 15W-40 or engine oil HD-SAE 5W-30, 5W-40, 10W-30, 10W-40, 15W-30, 15W-40 in accordance with API-CD. HD-SAE 20W-20 to API-CD also allowed for temperatures above 10 °C	after 1000 op. hours, then every 2 years every 1000 op. hrs.
Fuel tank	530.0	Diesel 5)	Fill up after use.
Cooling system	26.0	water with 35 - 50 % vol. antifreeze and anticorrosion agent 6)	Change antifreeze every 2 years.
Brake and clutch system	0.8	Pentosin CHF 11S (X 902.011.622)	every 2 years.
Compressed air system	0.5	Ethyl alcohol antifreeze (X 902.015.003)	Fill only at temperatures below + 5 °C.
Lubrication points		Fendt Ultra lithium grease, Fendt Extra Fett EP or lithium-saponified grease, NLGI class 2 (worked penetration factor 265-295).	see Lubrication Chart regularly oil all other joints and bearing surfaces.

1. Filling levels are determined with a dipstick or by overflow at filling screws etc.
2. Whichever comes first.
4. For registered tradenames, refer to current list of Fluids and Lubricants which is available from every Fendt-authorized workshop.
5. If diesel fuel contains more than 0.5 % sulphur, the oil change frequency must be halved. Below 0.05 % we suggest to check and keep the lubricating properties by adding additives. Only use alternative fuels, e.g. RME, once discussed with the Service Workshop.
6. Only use coolant as designated in Customer Service memo 11/02.

3) VISCOSITY OF ENGINE OILS

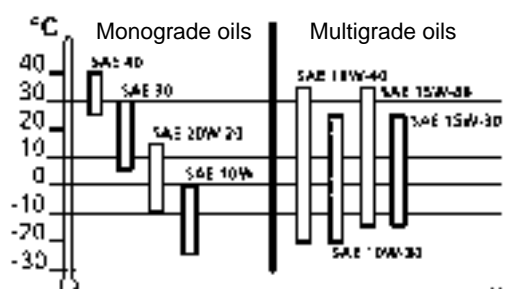

4.1 Bio-diesel

Fuel grade

RME R rape seed- M ethyl- E ster,
PME V egetable oil- M ethyl- E ster fuel
according to DIN 51606 are fuels to be used.
Cold-pressed rape seed oil cannot be used.

Maintenance intervals

Oil and oil filter change intervals should be halved.

After filling a few times with biodiesel, after having used conventional diesel fuel, the fuel filter must be replaced. Since biodiesel acts as a solvent, diesel residues may block the fuel filter.

Instructions for use

Biodiesel is suitable for winter temperatures down to about -10 °C.

At temperatures below -10 °C, diesel fuel needs to be added to prevent coagulation of the biodiesel. 50 % Diesel must be added per tank filling.

With temperatures below -16 °C, use only diesel.

Biodiesel can be mixed in any proportion with diesel fuel.

This may slightly reduce power output.

Fuel consumption can be slightly increased.

If the tractor is not going to be used for some time (3 months or more), fill with diesel to prevent the fuel injection pump from seizing.

Special features of biodiesel

Biodiesel is obtained from plant oil (mainly rape seed oil) by means of a chemical process, where the vegetable oil is mixed with methanol and converted to biodiesel using a catalyst.

Biodiesel is virtually sulphur-free, and the engine therefore produces almost no SO₂ (sulphur dioxide).

The exhaust gases contain

- carbon monoxide
- hydrocarbons
- particulates (e.g soot)

than when using conventional diesel.

Biodiesel is biodegradable and does not endanger ground and water in case of accidents.

4.2 Bio hydraulic oil

Bio hydraulic oil qualities

Use bio-hydraulic fluid made from vegetable oil, rape seed oil and synthetic oils, according to viscosity standard ISO VG 32 - ISO VG 46.

NOTE:

Do not use polyglycol-based synthetic oils.

Maintenance intervals

Oil and oil filter need to be changed every 1,000 operating hours or every year, whichever comes first.

After changing over to bio hydraulic oil, change hydraulic oil filter after approx. 10 - 15 operating hours. BIO hydraulic oil has solvent properties and may cause clogging of the filter in reaction with normal oil.

Instructions for use

Bio hydraulic oil is suitable for winter operations in temperatures down to approx. -15 °C.

Bio hydraulic oil may lose viscosity in outside temperatures below -15 °C and prolonged periods of non-operation of the tractor. After a cold start, allow a short warm-up time at medium engine speed to ensure safe operation of the hydraulic steering and lifting gear. In conditions of severe cold, it may be necessary to warm up the whole tractor.

Avoid mixing bio-hydraulic fluid with other oils, e.g with other, normal oil remaining in the system, or by operating an external implement.

This may affect the positive environmental properties of the fluid, and will make it more difficult to dispose of (it will then have to be considered as special waste).

When disposing of oil, current legislation and the instructions of the oil manufacturer are to be observed.

A mixing of more than 10% may result in alterations in viscosity and may lead to problems with the valves.

Special features of bio hydraulic oil

It is biodegradable and ground and ground water will not be affected in case of accidental spills.

IMPORTANT:

In spite of the high environmental compatibility of bio-hydraulic fluid, accidental spills must always be reported.

5. Lubrication chart

5.1 Filling points



Engine:
turn dipstick (B) and
remove, fill with
engine oil (A).



Hydraulic system:
Unscrew filter cover
(A). Fill with oil.



Transmission:
Turn dipstick (A) and
remove, fill with
transmission oil.



Brake and clutch
system:
Fill container
(arrowed) with
Pentosin CHF 11S.



Axle drives, each
side:
Pour in oil through
filler hole (B).



Cooling system:
Pour clean, low-lime
water containing
anti-freeze into con-
tainer (arrowed).



Front axle
differential gear:
Fill up to overflow at
filler hole (A).



Windshield washer
system:
Pour fluid into
container (A).

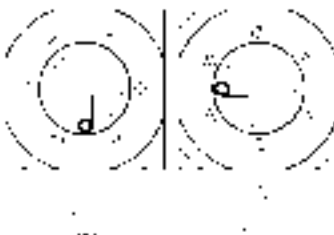

Front axle hub
drives:
fill until the oil spills
over, with hole on
the left and marker
in horizontal
position.



Compressed-air
system:
Fill antifreeze
container (B) with
ethyl alcohol.



Front PTO:
Fill up to overflow at
filler hole (A).



Fuel tank:
fill with fuel through
filler neck (A).



Lift shaft:
fill until oil is approx.
40 mm below filler
hole (A).

TECHNICAL DATA

5.2 Lubrication points

Maintenance intervals after:

125 operating hours



Extendable struts.

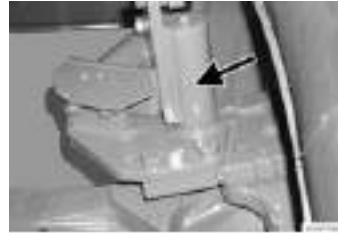

Automatic mudguard adjustment.



Automatic trailer hitch with cylinder-type bolt.



Hand brake shaft (A).



Automatic trailer hitch with ball-type bolt.

NOTE:

For machines with hydraulic trailer hitch (see OPERATION Fig. 249).

250 operating hours



Mechanical trailer hitch.



Double cardan U-joints on front-wheel drive.



Bottom lift cylinder bearing of front axle suspension.



Front power lift shaft.



Front axle swing arm.



V-belt tensioner.



Maintenance Schedule

FENDT 916 Vario, 920 Vario, 924 Vario, 926 Vario, 930 Vario

Vehicle Nos. 916 .. 7001, 920 .. 7001, 924 .. 7001, 926 .. 7001, 930 .. 2001

Maintenance jobs during and after the running-in period and for the workshop after the 5th Service

No.	Services					regularly 1)		daily	Job Schedule	General notes and technical data, types of fluid and oil
	1.	2.	3.	4.	5.	annu al or every 500	every 2 years or 2000			
	operating hours									
1								X	Engine	<p>The difference between the MIN and MAX marking on the dipstick is approx. 4.0 litres.</p> <p>After 100 operating hours add oil to the MAX mark of the dipstick.</p> <p>Wait until level is just above the MIN marking. Do not fill above MAX marking.</p> <p>Oil quantity: 24.0 litres</p> <p>Oil grade: Fendt Extra Grade 15W-40 SHPD, Fendt Ultra Grade 10W-40 UHPD or SHPD engine oils acc. to ACEA E3-96.</p> <p>Valve clearance: Intake valve 0.5 mm, exhaust valve 0.5 mm, with engine cold (max 50 °C).</p> <p>Repeat more often if engine output begins to fall.</p> <p>Repeat more often if engine output begins to fall.</p> <p>Repeat more often if engine output begins to fall.</p> <p>Air conditioner compressor: 400+50 N (40+5 kp). Alternator left side. 450+50 N (45+5 kp).</p> <p>Adjust to distance of 92 mm between centres.</p> <p>Coolant level: With the engine cold, top up if necessary with clean, lime-free water containing antifreeze to between the MIN and MAX mark on the expansion reservoir.</p> <p>Coolant quantity: 26.0 litres</p> <p>A concentration of 35 - 50% vol. of antifreeze and anticorrosion agent is necessary throughout the year, even in frost-free areas.</p> <p>Add anti-freeze as indicated in Fendt Customer Service memo 11/02.</p>
	X		X		X	X			Check oil level.	
		X				X	1000		Replace engine oil and filter cartridge 2).	
					X	X	1000		Check valve clearance, adjust if necessary (at workshop).	
		X				X	as re- quired		Clean the filter strainer and filter chamber in the fuel hand pump.	
					X	X	annu- ally		Replace fuel filter unit.	
					X	X	as re- quired		Replace preliminary fuel filter (optional).	
		X		X		X	X		Check V-belt, retighten if necessary 1).	
			X			X		V-belt tightener.		
	X		X		X	X		X	Check coolant level, top up if necessary.	
							X		Replace coolant.	

No.	Services					regularly 1)		daily	Job Schedule See also Operating Manual Care and Maintenance	General notes and technical data, types of fluid and oil
	1.	2.	3.	4.	5.	annu al or every 500	every 2 years or 2000			
	operating hours									
								X	Clean the fan shroud.	Clean with high-pressure cleaner - also refer to Fendt Customer Service memo 12/02.
	X		X		X	X		as requi- red	Check, and if necessary clean the cooling fins on engine, hydraulic system, charge air, transmission and air conditioning system.	Blow out with compressed air or with a dust extractor.
								as requi- red	Air filter maintenance.	Maintenance required only if a fault (symbol) is indicated on the multiple display. Clean with compressed air at 5 bar max., then check for damage.
	X		X		X	X		X	Replace air filter main cartridge.	There should be no cracks on the intake hoses.
									Check air filter suction line for leaks, check maintenance switch and indication on multiple display 1).	There should be no cracks on the intake hoses.
						X	1000		Clean the heater and roof fan filters.	Repeat more frequently if fan output begins to fall.
						X	X		Clean the recirculating air filter of heater and roof fan.	Repeat more frequently if fan output begins to fall.
2	X		X		X	X			Transmission	Top up if necessary. For Min and Max marks, see reservoir.
								X	Check fluid level in reservoir for brake and clutch actuation 1).	
									Fluid for brake and clutch operation.	Filling capacity: 0.8 litres
								X	Check oil level in transmission and differential.	Type: Hydraulic oil Pentosin CHF 11 S (X 902.011.622).
									Change the transmission oil and replace transmission oil suction filter.	Quantity of oil between MIN and MAX markings: approx. 3.0 l
	X				X	1000 on in- dica- tor		X	Replace transmission oil pressure filter.	Max. oil quantity: 85.0 litres
									Front PTO: replace transmission oil.	Oil quantity: Vario 916-920 refill 65.0 l
										Oil quantity: Vario 924-930 refill 67.0 l
										Oil grade: Fendt Extra Trans 10W-40 or STOU SAE 10W-40 or 15W-40 acc. to API GL4 4).
										If the 'Pressure filter dirty' symbol appears on the multiple display, replace filter as soon as possible.
										Oil quantity: 4.2 litres
										Oil grade: Fendt Super Trans 85W-90, 80W or Hypoid transmission oil acc. to API-GL5. SAE 85W-90 or SAE 80W-90 or SAE 90. Not STOU or other any universal oil.

No.	Services					regularly 1)		daily	Job Schedule See also Operating Manual Care and Maintenance	General notes and technical data, types of fluid and oil Correct levels are determined by dipstick check or from the overflow at the inspection hole. Observe all accident prevention regulations and comply with directives for handling and disposing of fluid and lubricants.
	1.	2.	3.	4.	5.	annu al or every 500	every 2 years or 2000			
	operating hours									
	X				X	X			<p>Check oil level in axle drives or front PTO gear 1).</p> <p>Oil change for axle drives.</p> <p>Oil change for axle drives with rear axle stub (optional).</p>	<p>Oil level: up to overflow on filler hole.</p> <p>Oil quantity: Vario 916-920 each side 13.0 l</p> <p>Oil quantity: Vario 924-930 each side 16.0 l</p> <p>Oil grade: Fendt Super Trans 85W-90, 80W or Hypoid transmission oil acc. to API-GL5. SAE 85W-90 or SAE 80W-90 or SAE 90. Not STOU or other any universal oil.</p> <p>Oil quantity: 16.0 litres each side.</p> <p>Oil grade: Hypoid transmission oil in accordance with API-GL5. SAE 85W 140 Do not use STOU or any other universal oil.</p>
3			X			X			<p>Front axle</p> <p>Check oil level in differential gears and hub drives.</p> <p>Oil change for differential and hub drives.</p> <p>Check toe-in. Adjust, if necessary.</p>	<p>Oil level up to overflow at check bore, top up if necessary.</p> <p>Oil quantity: Differential gears 9.5 Ltr.</p> <p>Oil quantity: Axle hub each side 4.0 Ltr.</p> <p>Oil grade: Fendt Super Trans LS 85W-90 or Hypoid transmission oil with LS additives acc. to API-GL5. SAE 85W-90 or SAE 80W-90 or SAE 90. Not STOU or other any universal oil.</p> <p>Toe-in: 0 ±1 mm.</p>
4			X						<p>Hydraulic system</p> <p>Replace return line filter.</p> <p>Change oil, including return line filter and air vent filter.</p> <p>Replace fine filter for control pressure.</p>	<p>Oil quantity: about 70.0 l (extraction flow: 50.0 l)</p> <p>Oil quantity: Maximum fill ca. 100.0 l. (available: 80.0 l)</p> <p>Oil grade: Fendt Super Hyd, Fendt Extra Hyd 68 or STOU SAE 5W-30, 5W-40, 10W-30, 10W-40, 15W-30, 15W-40 or engine oil HD-SAE 5W-30, 5W-40, 10W-30, 10W-40, 15W-30, 15W-40 acc. to API-CD.</p> <p>Also permissible: For temperatures over 10°C, HD-SAE 20 W-20 to API-CD.</p>

No.	Services					regularly 1)		daily	Job Schedule See also Operating Manual Care and Maintenance	General notes and technical data, types of fluid and oil Correct levels are determined by dipstick check or from the overflow at the inspection hole. Observe all accident prevention regulations and comply with directives for handling and disposing of fluid and lubricants.
	1.	2.	3.	4.	5.	annu al or every 500	every 2 years or 2000			
	operating hours									
	X						X		<p>Check oil level of lifting shaft lubrication. Top up, if necessary. (Only if leaking).</p> <p>Oil level: Check using a measuring strip of about 40 mm straight length.</p> <p>Oil grade: Fendt Extra Trans 10W-40 or STOU SAE 10W-40 or 15W40.</p>	
5			X		X	X			<p>Electrical, electronic systems</p> <p>Check battery acid level; if necessary top up with distilled water. Not applicable to maintenance-free batteries.</p> <p>Check lighting and signalling system and all monitoring and warning systems for correct operation. Read out up diagnostic memory and remedy the faults.</p> <p>Check software version and interconnection of the electronic components and update if necessary.</p>	<p>Level about 15 mm above top of plates. Open-circuit voltage with battery fully charged 12.75 V.</p> <p>Short circuit sensor. A fault message (symbol) must appear on the multiple display accompanied by an intermittent audible signal.</p> <p>Complete tractor programming with end-of-line program - check interconnection.</p>
6	X		X		X	X		X as required	<p>Compressed air system</p> <p>Drain the water from the bottle.</p> <p>Check antifreeze level.</p>	<p>Pull cable to operate drainage valve.</p> <p>Top up with antifreeze at temperatures below 5 °C.</p> <p>Antifreeze: ethyl alcohol (X 902.015.003).</p>
7	X		X		X	X			<p>Assemblies / general</p> <p>Check that bolted connections are firmly seated, especially on engine, transmission, front axle, body and hydraulics; tighten if necessary. Tighten hydraulic screw connections only in the event of a leak. In particular, check steering and front hydraulic hoses for chafing points.</p> <p>Check the trailer hitch.</p> <p>Check and correct tyre pressure, if necessary.</p> <p>For lubrication of greasing points refer to Lubrication chart, lubricate all joints.</p> <p>Test drive the tractor, checking braking efficiency, adjust if necessary.</p>	<p>Check for chafing points on hydraulic hoses, loose parts or missing protection devices.</p> <p>Switch off engine before tightening the pressure lines.</p> <p>With front axle suspension, unload the pressure lines as well.</p> <p>Swivel joint on trailer hitch: maximum play 3 mm.</p> <p>See technical data.</p> <p>Fendt Ultra lithium grease, Fendt Extra EP or multi-purpose grease, lithium-saponified, NLGI class 2 (worked penetration 265 - 295).</p> <p>At 20 km/h, tractor must come to standstill within a stopping distance of 4 - 6 m.</p>

No.	Services					regularly 1)		daily	Job Schedule See also Operating Manual Care and Maintenance	General notes and technical data, types of fluid and oil
	1.	2.	3.	4.	5.	annu al or every 500	every 2 years or 2000			
	50	250	500	750	1000	operating hours				
	X		X		X	X			Check active parking function.	Brake pedal free play max. 110 mm. After the test drive. Stop the tractor using the joystick. Active symbol appears in the multi-display. After the tractor has been stationary for about 5 seconds, open the emergency operation cover. Engage driving mode II, turn the transmission adjuster about 15 degrees to the left. The tractor should not move forward.

For summary of services, see Operating Manual (inside back cover) and also the workshop data card.

- 1) Max. values Whichever comes first. In difficult operating conditions, more frequent maintenance is recommended. Always have the main service carried out **before** long periods of non-use.
- 2) If the fuel contains more than 0.5% sulphur, the oil replacement intervals should be halved.
- 4) For registered trade names, refer to the current list of Fluids and Lubricants, which is available (as customer information) from every Fendt-approved workshop.

3) VISCOSITY OF ENGINE OILS

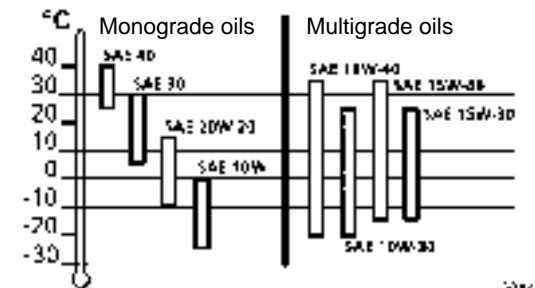

TECHNICAL DATA

A

Acceleration rates	38
Activating fuel consumption measurement	48
Activating the accelerator pedal function	50
ACTIVE symbol	38
Actuating the stored speed	44
Adjustable	28
Adjusting speed indicator	111
Adjusting the radar sensor	82
Air conditioning compressor V-belts	147
Alternator	160
Antifreeze	34
Antifreeze pump/tank	104
Automatic trailer coupling	98

B

Backup indicators	113
Ball coupling	99
Battery	160
Bleeding the fuel system	143
Brake and clutch system	148

C

Calculation of trailer weights	96
CARE AND MAINTENANCE	139
Change of direction of travel	37
Changing direction of travel	42
Changing the hydraulic oil	154
Changing the oil in the axle drives	151
Changing the oil in the front axle differential gear	151
Changing the transmission oil	149
Checking coolant level	158
Checking engine oil level	141
Checking oil level in power lift	153
Checking the transmission oil level	150
Checking toe-in	156
Cleaning the radiator	145
Cleaning the tractor	159
Cleaning the viscous fan	145
Clearing a warning or fault message	215
Clock	19
Clutch pedal	41
Compressed air system	104
Computer	114
Condenser	158
Connect jump leads to the discharging tractor's battery in sequence	36
Cruise control	44

D

Dashboard	17
Depth control	75, 77, 92
Difference in engine oil quantities	141
Differential lock	58
Dimmer	17
Dipstick	141

Displaying stored fault codes	112
Document box	19
Draining condensation water from the air bottle ..	105
Draining engine oil	140
Draw bar	101
Driving mode selector	39
Driving the tractor	40

E

Electronic slip control	81
Electrowelding	160
Engine management system	50
Engine speed	18
Engine temperature	18
EPC automatic mode	75
EPC safety lock	76, 90
Extendable lifting struts	86
External control	83
External hydraulic connection	74

F

Fast feed-in	75, 79
Fault code tables	229
Fault display	112
Fault messages	211
FAULTS AND REMEDIAL ACTIONS	205
Filling tyres	104
Filling with engine oil	141
Final speed control	41
Flange PTO shaft	55
Floating position	72, 94
Fluid reservoir	159
Foot brake	63
Four wheel drive (4-WD)	58
Front axle suspension	59, 152
Front external controls	93
Front hydraulic connections	75
Front power lift	88
Front PTO oil level	149
Front PTO speed	18
Fuel and lubricants	253
Fuel consumption measurement	48
Fuel prefilter	143
Fuel supply	18
Fuses	163

G

Glow and starter switch	16
-------------------------------	----

H

Hand brake	63
Hand throttle	19
Hazard light	17
Hazard warning flasher switch	17
Hazard warning triangle	37
Headlight flasher	16
Heated rear windshield	28

ALPHABETICAL INDEX

High beam	16
Hitching a trailer manually	97
Hitch-lift	75
Horn	16
Hydraulic connections, rear	74
Hydraulic trailer brake	64
Hydraulic trailer hitch	102
Hydraulics	65
I	
Implement control	120
Implement socket	85
Implement socket	29
IMPLEMENTS	204
J	
Joystick	37
Jump leads	36
Jump starting	36
L	
Left indicator	16
Lift height limiting	76, 78, 92
Lift speed	93
Load limit control	46
Locking the hydraulic valves	22
Lower links	85
Lowering speed	76, 78, 92
Lubrication chart	255
M	
Main cartridge	144
N	
Neutral position	37
O	
On-board computer	111
On-board electrical system voltage	18
Operating hours	19
Operating the valves	67
OPERATION	14
P	
Piton fix	102
Position of the power lift	76, 78, 92
Position/traction mix control	76, 78
Power lift automatic mode	60
Power lift lock	76, 90
Priority function	69
Programmed changes of travel direction	43
PTO	53
PTO automatic mode	61
PTO automatic mode with power lift	62
PTO clutch	56
PTO speed	54
Q	
Quick Lift key	75, 77, 91

R	
Radar sensor	81
Reading out a fault code	211
Rear PTO speed	18
Removing the heater fan filter	157
Replacing air vent filter	155
Replacing coolant	146
Replacing intake filter	150
Replacing pressure filter	150
Replacing the	142
Replacing the control pressure fine filter	155
Replacing the engine oil filter	140
Replacing the oil in front axle hub drives	152
Replacing the recirculating air filter	158
Replacing the return line filter	154
Replacing the roof fan filter	157
Reset function	31
Reversing device	204
Right indicator	16
Road haulage	80, 95
S	
Safety cartridge	145
SAFETY INSTRUCTIONS	9
Select main menu	114
Selecting acceleration rates	38
Selecting tyre size	112
Setting the clock	111
Setting the valves	70
Slip control	76
Socket (blue) for external pulse counter	29
Space for radio installation	28
Steering wheel adjustment	16, 65
Storing engine speeds	47
Storing speeds	45
Storing the settings	117
Swing compensation	88
T	
TECHNICAL DATA	247
Three-point link	85
Timer function	71
Top link	87
Top up with fuel	33
Towing instructions	48
Tow-starting	37
Tractor Management System	49
Trailer socket	29
Travel direction indicator lamps	37
Turboclutch	40
Twin tyres	110
U	
Unlocking the front power lift	91
Unlocking the power lift	76

V

Valve equipment	67
Valve heating	69
Variotronic Ti	126
Variotronic Ti fault messages	223
V-belt	147
V-belt tension	147, 159
Vehicle Identification Number	4
Vibration damping	80

W

Warning beacon	28
Warning light	38
Warning messages	205
Wheel slip indicator	18
Windshield washer system	16, 159
Windshield wipers	16
Winter fuel	34
Work lamps	28

Important information on service and maintenance

Your tractor will only perform to your complete satisfaction if you take good care of it from the very start. Your Customer Service Centre will therefore prepare your tractor, free of charge, and instruct you on how to operate and maintain it.

Protect your claims under Warranty by having all servicing carried out at the correct time by an authorised FENDT service workshop!

After 50 operating hours (1st service)

After 500 operating hours (2nd service)

After 1000 operating hours (3rd service)

All subsequent maintenance will be carried out at our customer workshops by skilled technicians at reasonable cost and as indicated in the Maintenance Schedule of this Operating Manual.

To extend the life of the tractor, we recommend our annual Major Service, which includes an engine oil change, immediately after the main working season (e.g. the autumn).

During the initial 100 operating hours, it is not advisable to subject the tractor to extreme loads.

Every 100 operating hours, top up engine oil to the upper notch on the dipstick.

Make sure that only FENDT original parts are used for all services and repairs.

Unauthorised changes and modifications, and any damage resulting from rigidly mounted implements (e.g. front loader) not purchased from FENDT, are not covered by the Warranty and are entirely at the owner's risk. This applies in particular to modifications to the power output limiter and maximum speed settings, and any damage as a result of exceeding the maximum permissible loads and weights.

Services carried out according to the Maintenance Schedule:

50 operating hours First service	2000 operating hours	4500 operating hours
Date and signature of mechanic	Date and signature of mechanic	Date and signature of mechanic
500 operating hours Second service	2500 operating hours	5000 operating hours
Date and signature of mechanic	Date and signature of mechanic	Date and signature of mechanic
1000 operating hours Third service	3000 operating hours	5500 operating hours
Date and signature of mechanic	Date and signature of mechanic	Date and signature of mechanic
1500 operating hours	3500 operating hours	6000 operating hours
Date and signature of mechanic	Date and signature of mechanic	Date and signature of mechanic