

MAHINDRA

T R A C T O R S

OPERATOR'S MANUAL & INSTALLATION INSTRUCTION 'ML170' Series

Click here to go on

[INDEX](#)

[Main Menu](#)



Cultivate
Your
DreamsSM

**Includes: Operator's Manual and Installation
Instructions**

Mahindra USA

Model ML170

Front End Loader



1503-1066

WARRANTY CONDITIONS

Warranty Coverage:

Mahindra USA, Inc., herein referred to as Mahindra, undertakes to replace or repair any part of a Mahindra loader where damage has been proven to be caused by defects in material or workmanship.

This Warranty is valid for a period of 1 year for all hydraulic components and attachments and for a period of 2 years for all other loader components from the date of the original retail sale. Parts replaced or repaired under the terms of this Warranty are guaranteed only until the original warranty expires.

It is further understood and agreed that the defect should be immediately reported to the Selling Dealer. The Selling Dealer will generally perform Warranty repairs or replacements and the Purchaser shall deliver the Mahindra Loader to the Dealer's place of business for repair. In the event Purchaser is located more than 75 miles from the Selling Dealer, any Mahindra Dealer authorized to sell and service Mahindra Products may perform the repair at its dealership.

The obligation of Mahindra to the Purchaser under this Warranty is limited to the repair or replacement of defective parts by an authorized Mahindra dealer. Repair or replacement in accordance with this Warranty shall constitute fulfillment of all liabilities of Mahindra and the Selling Dealer in respect to Mahindra Loaders.

There are no warranties beyond those which expressly appear herein. Any implied warranty of merchantability or fitness for a particular purpose is specifically excluded here from.

Warranty Provisions:

Mahindra's liability under this Warranty is subject to the observance by the Purchaser of the following provisions:

- The purchaser shall at all times in the operation of any Mahindra Product, use those brands and grades of lubricating oils, lubricants or fuel and spare parts officially approved by Mahindra.
- The Mahindra Loaders shall have been used in accordance with the procedures specified in the Operator's Manual. This Warranty does not extend to damage resulting from misapplication, abuse, misuse, failure to perform maintenance, negligence, fire, accidents or changes or faulty mounting carried out by the Purchaser. When making a Warranty exchange of parts, the Purchaser shall compensate Mahindra for the time that the parts have been used if they have been exposed to extreme wear.
- Compensation is not paid for physical harm, deadlock, resulting damages, or other losses.
- To obtain warranty service, the Purchaser must (1) report the product defect to an authorized Mahindra dealer and request repair within the applicable warranty term and (2) present evidence of purchase or date of original use.
- The Warranty shall be void if the Mahindra Loader has been altered or repaired outside of a Mahindra dealership in a manner, which, in the sole judgment of Mahindra, affects its performance, stability, or reliability.
- The customer shall be responsible for transportation expenses for the Mahindra Loader to the dealership or travel of dealer personnel to customer location for Warranty repair. The customer shall also pay any premium for overtime labor requested by the customer.
- Temporary repairs or additional costs due to the work being performed after normal working hours will not be compensated.
- The above warranty is in lieu of all other warranties on Mahindra's behalf and neither party assumes any other liability in connection with Mahindra's Products.
- Any dispute arising between Mahindra and the Purchaser concerning the liability of Mahindra under this warranty shall be subject to the laws of the State of Texas.

Right To Make Design and Product Changes:

Mahindra reserves the right to make changes in the design and other changes in its Mahindra Products at any time without incurring any obligation with respect to any product previously ordered, sold or shipped.

CONGRATULATIONS

You are now the proud owner of a MAHINDRA ML170 Loader. This loader is a product of quality engineering and manufacturing. It is made of fine materials and under a rigid quality control system. It will give you long, satisfactory service. To obtain the best use of your loader, please read this manual carefully. It will help you become familiar with the operation of the loader and contains many helpful hints about loader maintenance. The immediate use of new techniques in the manufacture of products may cause some small parts of this manual to be outdated. Mahindra dealers will have the most up-to-date information. Please do not hesitate to consult with them.

SAFETY ALERTS

This symbol, the industry's "Safety Alert Symbol," is used throughout this manual and on labels to warn of the possibility of personal injury. When you see this symbol, carefully read the messages and be alert to the possibility of injury or death. It is essential you read these instructions and safety regulations before you attempt to assemble or use this unit.

**DANGER:**

Indicates an imminently hazardous situation which, if not avoided, will result in death or serious injury.

**WARNING:**

Indicates a potentially hazardous situation which, if not avoided, could result in death or serious injury.

**CAUTION:**

Indicates a potentially hazardous situation which, if not avoided, may result in minor or moderate injury.

IMPORTANT:

Indicates that equipment or property damage could result if instructions are not followed.

NOTE:

Gives helpful information.



SAFETY

Most tractor and/or loader equipment accidents can be avoided by following simple safety precautions. The safety information given in this manual does not replace safety codes, insurance requirements, federal, state, and local laws. Make sure your machine has the correct equipment required by your local laws and regulations. Understand that your safety and the safety of other persons are measured by how you service and operate this loader.

Know the position and operations of all controls before you try to operate. Make sure you check all controls in a safe area before starting.

Read this manual completely and thoroughly and make sure you understand all controls. All equipment has a limit. Make sure you are aware of the stability and load characteristics of this loader before you begin operation.



This safety alert symbol indicates important safety messages in this manual. When you see this symbol, carefully read the message that follows and be alert to the possibility of personal injury or death.



SAFETY PRECAUTIONS



READ MANUALS AND DECALS

1. Read and understand both the tractor and the loader Operator Manuals and all decals before using the loader.
2. Lack of knowledge can lead to accidents.
3. It is the loader owner's responsibility to make sure anyone operating the loader reads and understands this manual first before operating the machine.
4. Follow all safety, operating, and service instructions.
5. Replace damaged or illegible safety labels. See following pages for required labels.

ROPS AND SEAT BELT

6. Equip your tractor with an approved rollover-protective structure (ROPS) or ROPS Cab and seat belt for your protection.
7. ROPS (Roll-Over Protective Structures) and seat belt equipped tractors are recommended for operator use in all loader operations.
8. Operator should wear safety hard hat, safety glasses, safety shoes, and other PPE. Avoid wearing loose clothing or jewelry that may catch in moving parts.
9. Use seat belt as specified by tractor/ROPS manufacturer.

YOURSELF

10. Do not stand, walk, or work under a raised loader bucket or attachment unless it is securely blocked and held in position.
11. Operate controls only when properly seated in the operator's seat.
12. Only one person, the operator, should be on the machine when it is in operation.
13. Accidental movement of valve handle/handles or leak in the hydraulic system could cause the loader to drop, or attachment to dump, causing severe injury.

OTHERS

14. Do not allow anyone in loader work area, under raised loader, or to reach through the loader boom when the bucket or attachment is raised.
15. A frequent cause of personal injury or death is persons falling off and being run over. Inadvertent movement of the loader or attachment could result in serious injury or death.
16. Do not permit others to ride on your tractor, loader, bucket, or any attachment.
17. Do not lift or carry anyone on buckets, forks, probes, or any other portion of the loader or loader attachments.
18. Do not allow children or unqualified persons to operate equipment.





SAFETY PRECAUTIONS



PREPERATION

19. Move the wheels to the tractor manufacturer's widest recommended settings to increase stability.
20. For better stability, always use a tractor equipped with a wide front axle, never use a tractor equipped with a tricycle type front axle.
21. Add rear ballast or rear weight to the tractor to compensate for the load and increase stability.
22. Add recommended rear tire liquid weight or rear wheel weights for increased stability.
23. Do not modify, alter, or permit anyone else to modify or alter the loader, any of its components, or any loader function without first consulting a Mahindra dealer.
24. Assemble, remove, and reinstall the loader only as directed in this manual. Failure to do this could result in serious personal injury or death.
25. The loader may shift during shipping and handling, making it unstable on the pallet. Support loader with an overhead hoist or other suitable means prior to removing bands or attaching straps securing loader to pallet. Failure to do so could result in accidental tip-over of the loader that could cause serious injury to you and/or bystanders.

BEFORE OPERATION

26. Before starting the engine of your tractor, make sure all operating controls are in park lock or neutral position.
27. Be certain lights and safety markings, as provided by the tractor manufacturer, are clean and operating when transporting the tractor/loader on public roads. Be certain that the Slow Moving Vehicle (SMV) emblem is visible. Check with local law enforcement for specific requirements.

OPERATION

28. Add wheel ballast and/or rear weight to counterbalance tractor/loader for stability at maximum loader capacity.
29. Additional counterweight requirements will vary with loader attachments and equipment application.
30. Move and turn the tractor at low speeds.
31. Carry loader boom at a low position during normal operation.
32. Never travel at high speeds with bucket loaded.
33. Use caution when operating the loader with a raised bucket or attachment.
34. Avoid driving over loose fill, rocks, holes, or anything that may be dangerous for loader operation or movement.
35. Allow for the loader length when making turns.
36. Use caution when handling loose or unstable loads.
37. Gradually stop the loader boom when lowering or lifting loads.
38. When using remote hydraulic tractor valves on some tractors, the loader lift and dump cylinders will continue moving unless the valve handle/handles are manually returned to neutral, or until relief pressure is reached at the ends of piston strokes. Observe the bucket movement and maintain control with valve handle/handles.
39. Travel speed should be such that complete control and machine stability is maintained at all times. Where possible, avoid operating near ditches, embankments, and holes. Reduce speed when turning, crossing slopes, and on rough, slick or muddy surfaces.
40. A loader attachment should be transported in a low position at slow ground speeds. Make turns slowly and use the tractor brakes cautiously. A loaded attachment in the raised position alters the center of gravity location of the machine and increases the possibility of mishaps.
41. Be careful during loading, transporting, and stacking to minimize rolling bales and tractor tip over.
42. Do not use buckets, forks, or other attachments without bale retaining devices.
43. Operate the tractor and loader such that complete control and machine stability is maintained at all times.
44. When using a loader, be alert of bucket or attachment position at all times. Loader in raised position with bucket or attachment rolled back can dump material onto tractor causing damage or injury to tractor and/or operator.

LARGE HEAVY OBJECTS

45. Never use loader for handling large heavy objects, such as large round or rectangular bales, logs, and oil drums unless loader is equipped with attachment that is designed to handle such objects.
46. Handling large heavy objects can be extremely dangerous due to danger of rolling the tractor over.
47. Handling large heavy objects can be extremely dangerous due to danger of upending the tractor.
48. Handling large heavy objects can be extremely dangerous due to danger of the object rolling or sliding down the loader boom onto the operator.



SAFETY PRECAUTIONS



49. If you must handle large heavy objects, protect yourself by using caution, moving slowly, and avoiding bumps and rough ground.
50. If you must handle large heavy objects, protect yourself by never lifting load higher than necessary to clear the ground.
51. If you must handle large heavy objects, protect yourself by adding rear ballast to the tractor to compensate for weight of load.
52. If you must handle large heavy objects, protect yourself by never lifting large heavy objects that may roll or fall on the operator.
53. Never lift any load from any point of the loader with a chain, rope, or cable unless loader is equipped with a Factory approved attachment that was designed and built for this type of lifting. Always follow lifting instructions included with these attachments.
54. Use only Factory bale probe or bale retaining device handler attachment when handling round bales.
55. Do not handle large square bales without a retaining device handler attachment.
56. Do not use buckets, forks, or other attachments without bale retaining devices.
57. Do not use loader for handling large, heavy objects such as logs, tanks, etc.

SLOPES

58. Stay off of slopes too steep for safe operation.
59. Shift down before you start up or down a hill with a heavy load. Avoid "free wheeling."
60. Use extreme caution when operating on a slope.
61. Always operate up and down the slope, never across the slope.

ELECTRICAL

62. Avoid contact with overhead wires, power lines, and obstacles when loader bucket or attachment is raised.
63. Electrocution from power lines can occur with or without contact.
64. Check for underground utilities before digging below grade level.
65. Contact with overhead power lines can cause severe electrical burns or death from electrocution. Make sure there is enough clearance between raised equipment and overhead power lines.

HYDRAULIC

66. Do not tamper with the relief valve setting. This will void warranty and could cause damage to loader and/or tractor.
67. Escaping hydraulic fluid under pressure can have sufficient force to penetrate the skin, causing serious personal injury. Do not use HANDS to search for suspected leaks. If injured by escaping fluid, obtain medical treatment immediately.
68. Visually check for hydraulic leaks and broken, missing, or malfunctioning parts. Never use your hand to check for suspected leaks under pressure. Use a piece of cardboard or wood for this purpose. Escaping hydraulic fluid or diesel fuel leaking under pressure can have sufficient force to penetrate the skin and cause serious infection or other personal injury. If injured by leaking fluid, seek medical attention immediately.
69. To prevent personal injury, relieve all pressure before disconnecting fluid lines.
70. Before applying hydraulic pressure, make sure all hydraulic connections are tight and components are in good condition.
71. Be sure to purge all the air from the hydraulic system before attempting to raise or lower this machine.
72. When using remote hydraulic tractor valves on some tractors, the loader lift and dump cylinders will continue moving unless the valve handle/handles are manually returned to neutral, or until relief pressure is reached at the ends of piston strokes. Observe the bucket or attachment movement and maintain control with valve handle/handles.
73. Raised loader or boom can fall due to hydraulic system failure.
74. To avoid serious injury or death: Block up or securely support loader and boom before working underneath.
75. To avoid serious injury or death: Purge all air from hydraulic system before attempting to raise or lower loader or boom.
76. To avoid serious injury or death: Stand clear if lowering or raising loader or boom.
77. Do not use hand or skin to check for hydraulic leaks. Use cardboard or wood. Wear eye protection.
78. High pressure oil leaks can penetrate skin causing serious injury and gangrene. Consult a physician immediately.
79. Lower the loader or boom and release hydraulic pressure before loosening fittings.





SAFETY PRECAUTIONS



AFTER OPERATION

80. Before leaving the tractor seat, lower attachment or loader boom to ground, stop engine, lock parking brakes, put all controls in neutral, relieve hydraulic pressure, and remove key before leaving operator's seat.
81. Before disconnecting hydraulic lines, relieve all hydraulic pressure.
82. Make sure all parked loaders on stands are on a hard level surface with all safety devices engaged to prevent loader from falling and being damaged or injuring someone.
83. Always park loader with bucket attached to loader.
84. When a front loader is mounted on the tractor, enter and exit the operator's seat only from left side of the tractor.
85. Always park loader with a Factory attachment attached to the loader.
86. Special care should be taken to park or store attachments with points or sharp edges in a safe manner.
87. Make sure all parked loaders are on a hard level surface. Engage all safety devices to prevent loader from falling and being damaged or injuring someone. Do not repair loader if it is not mounted on the tractor. Loss of hydraulic fluid or removal of parts could cause loader to collapse resulting in injury.

REPAIR

88. Visually check for hydraulic leaks and broken, missing, or malfunctioning parts.
Make necessary repairs before operation.
89. To keep mounting kit hardware from loosening during loader operation, hardware must be torqued to specifications noted in operator manual.
90. Always wear safety goggles when servicing or repairing the machine.
91. When servicing or replacing pins in cylinder ends, bucket, etc., always use a brass drift and hammer. Failure to do so could result in injury from flying metal fragments.
92. Never tow from any point of the loader with a chain, rope, or cable. Doing so could cause a roll over or serious damage to the loader.





DANGER, WARNING, AND CAUTION DECAL SAFETY MESSAGES



0595-3000 WARNING DECAL

1. Add recommended rear wheel ballast and/or rear counter-weight for stability.
2. Move wheels to widest recommended setting to increase stability.
3. Move and turn tractor at low speeds.
4. In transport carry the load low.
5. Lower loader to the ground when parked.
6. Before servicing or adjusting equipment:
 - * lower loader to the ground.
 - * shut off engine.
7. Relieve hydraulic pressure before disconnecting oil lines.
8. Observe safety recommendations in Loader Operations Manual.

0595-3001 WARNING DECAL

Crushing Hazard

9. Stay away from under lift arms and bucket!
10. Do not stand or work under a raised loader.
11. Support bucket and lift arms before working under loader.
12. Lower loader to the ground before leaving seat.

0595-3002 DANGER DECAL

13. Keep machine clear of overhead power lines to avoid death or serious injury.

0595-3003 WARNING DECAL

14. To prevent rollback onto operator use special loader attachments for handling large objects such as stumps and large round bales.
15. Transport load as low as possible to avoid overturning.

0595-3004 WARNING DECAL

16. Read the operator's manual for complete operating instructions and safety information before operating the loader.
17. Be certain anyone operating the loader is aware of safe operating practices and potential hazards.
18. Operate the loader from the operator's seat only.
19. Do not lift or carry anyone on loader or work from bucket or attachment.
20. Do not walk or work under raised loader or bucket or attachment unless it is securely supported.
21. Avoid loose fill, rocks, and holes; they can be dangerous for loader operation or, movement.
22. Use extra caution when working on inclines.
23. Avoid overhead powerlines or obstacles when loader is raised.



DANGER, WARNING, AND CAUTION DECAL SAFETY MESSAGES



0595-2190 CAUTION DECAL

24. To prevent bodily injury and loader instability when detaching loader, equip loader with a material bucket.

0595-3050 DANGER DECAL

To avoid serious injury or death:

25. Unload only on a level surface.

26. Keep bystanders clear of work area when loading and unloading bales.

0595-3051 WARNING DECAL

27. Do not operate without confirmation that coupler pins are fully engaged.

28. Loader attachment can fall off if not properly attached.

To avoid serious injury or death:

29. Only use loader manufacturer approved attachments.

30. Read all operators manuals and decals before operating. Follow all safety operating and service instructions.

Contact dealer for replacement parts.

0595-3052 WARNING DECAL

To avoid serious injury or death:

31. Do not use pallet fork attachment to lift large objects, round bales, or items that may roll or slide down loader arms onto the operator.

32. Never operate pallet fork without attaching plate guard.

33. Keep loads below pallet forks attaching plate guard heights.

34. Always transport loads with pallet forks low and level to ground.

35. Always keep pallet forks level when raising loads.

36. Avoid raising loads to full heights with pallet forks rolled back.

37. ROPS (Roll-Over Protective Structures) and seat belt equipped tractors are recommended for operator use in all pallet fork operations.

38. Do not lift or carry anyone on buckets, forks, probes, or any other portion of the loader or loader attachments.

39. Do not allow riders on tractor, loader, or forks.

40. Avoid contact with electrical power lines by loader or attachments.

0595-3053 CAUTION DECAL

41. Maximum load limit on combined pair of forks is 5700 pounds.

0595-3054 CAUTION DECAL

To avoid serious injury or death:

42. Read operators manual and decals before operating.

43. Follow all safety operating, and service instructions. Contact dealer for replacement.

44. Be careful during loading transporting, and stacking to minimize rolling bales and tractor tip over. ROPS (Roll-Over Protective Structures) and seat belt equipped tractors are recommended for operator use in all bale probe operations.

45. Do not allow riders on tractor loader or bale probe.

46. Avoid loading/unloading bales on sloping or uneven surfaces.

47. Avoid transporting with bales raised high. Keep bales tilted back and low to the surface while moving.

48. Approach, penetrate, and transport bales at low speeds. Reduce speeds on curves, hills rough ground, or when turning.

49. Do not lift anything with bale probe except round bales.

50. Never raise round bale to full height with bale probe rolled back.

51. Park and store bale probe points pointed against bale, building, or other stable object.



SAFETY DECALS



WARNING

1. Add recommended rear wheel ballast and/or rear counterweight for stability.
2. Move wheels to widest recommended setting to increase stability.
3. Move and turn tractor at low speeds.
4. In transport carry the load low.
5. Lower loader to the ground when parked.
6. Before servicing or adjusting equipment;
* lower loader to the ground.
* shut off engine.
7. Relieve hydraulic pressure before disconnecting oil lines.
8. Observe safety recommendations in Loader Operations Manual.

0595-3000

WARNING

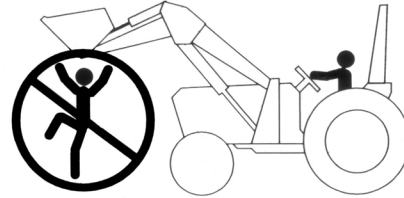

Crushing Hazard

Stay away from under lift arms and bucket!

1. Do not stand or work under a raised loader.
2. Support bucket and lift arms before working under loader.
3. Lower loader to the ground before leaving seat.

0595-3001

DANGER

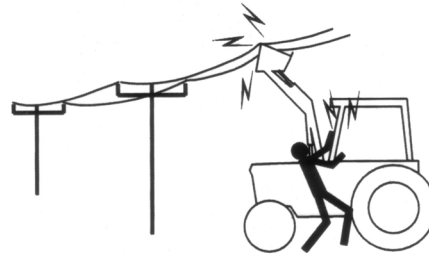

Keep machine clear of overhead power lines to avoid death or serious injury.

0595-3002



SAFETY DECALS



! WARNING



To prevent rollback onto operator - use special loader attachments for handling large objects such as stumps and large round bales.

Transport load as low as possible to avoid overturning.

0595-3003

! WARNING

1. Read the operator's manual for complete operating instructions and safety information before operating the loader.
2. Be certain anyone operating the loader is aware of safe operating practices and potential hazards.
3. Operate the loader from the operator's seat only.
4. Do not lift or carry anyone on loader or work from bucket or attachment.
5. Do not walk or work under raised loader or bucket or attachment unless it is securely supported.
6. Avoid loose fill, rocks and holes; they can be dangerous for loader operation or movement.
7. Use extra caution when working on inclines.
8. Avoid overhead powerlines or obstacles when loader is raised.

0595-3004



Safety Decal Locations

Important: Safety decals 0595-3000, 0595-3001, 0595-3002, 0595-3003, and 0595-3004 are located on the loader LH bearing box and are visible as you mount the tractor.

Care of Safety Decals

1. Keep safety decals clean and free of obstructing material.
2. Clean safety decals with soap and water and dry with a soft cloth.
3. Replace damaged or missing safety decals with new decals from your Mahindra Dealer.
4. If a component with a safety decal(s) affixed is replaced with a new part, make sure new safety decal(s) are attached in the same location(s) as the replaced components.
5. Mount new safety decals by applying on a clean dry surface and pressing air bubbles to outside edges.

TABLE OF CONTENTS

1. Specifications	14	10. Pin On Bucket	49
1.1. Attachment Specifications.....	14	10.1. Installation Instructions To Pin On Quick Attach	49
2. Introduction	15	10.2. Installation Instructions Direct To Loader	49
3. Installation Instructions	16	11. Pin On Bale Spear	50
3.1. Tractor Preparation	16	11.1. Pin On Bale Probe	51
3.2. Mounting Kit Installation.....	17	11.2. Assembly Instructions	51
3.3. Hydraulic Installation.....	21	11.3. Installation Instructions To Pin On Quick Attach	51
3.4. Loader Installation.....	28	11.4. Installation Instructions Direct To Loader	51
3.5. Connect Hydraulics.....	29	11.5. Operating Instructions.....	51
3.6. Bucket Level Indicator.....	30	12. Pin On Pallet Fork	52
Steering Stop	30	12.1. Pin On Pallet Fork.....	53
4. Pre-Operation Instructions	31	12.2. Assembly Instructions.....	53
4.1. Hydraulic Fluid	31	12.3. Installation Instructions Pin On Quick Attach	53
4.2. Initial Loader Operation.....	31	12.4. Installation Instructions Direct To Loader	53
4.3. External Loader Valve.....	31	12.5. Operating Instructions.....	53
4.4. Loader Mounted Valve Equipped With Single Handle Controller On A Loader Not Equipped With Hydraulic Self Level Option	32	12.6. Parking Instructions	53
4.5. Neutral Position.....	32	12.7. Parking Stability	53
4.6. Neutral Lock Position	32	13. Optional Pin On Quick Attach System	54
4.7. Float Position	32	13.1. Recommended Loader Factory Approved Attachments.....	54
4.8. Regenerative Dumping Position	33	13.2. Pin On Quick Attach	54
4.9. Initial Loader Operation.....	33	14. Installing Bucket Or Attachment To Pin On Quick Attach	55
4.10. Removing Air From Hydraulic System	33	14.1. Recommended Loader Factory Approved Attachments.....	55
4.11. Relief Noise	33	14.2. Operating Instructions.....	55
5. Daily Maintenance & Lubrication	34	15. Removing Bucket Or Attachment From Pin On Quick Attach	58
5.1. Daily Checks	34	15.1. Operating Instructions.....	58
5.2. Loader Lubrication	34	16. Service And Lubrication For Pin On Quick Attach	59
Service Areas.....	36	16.1. Keep These Areas Clean.....	59
6. Operating Instructions	37	16.2. Lubricate Annually	59
6.1. Filling The Bucket	37	17. Optional Skid Steer Tool Carrier System	60
6.2. Lifting The Load	37	17.1. Recommended Loader Factory Approved Attachments.....	60
6.3. Carrying The Load	37	17.2. Non-Loader Factory Attachments.....	60
6.4. Dumping The Bucket	38	17.3. Skid Steer Tool Carrier System Service & Lubrication	61
6.5. Lowering The Bucket	38	18. Installation & Operation Of Skid Steer Tool Carrier System	62
6.6. Operating With Float Control	38	18.1. Installation Instructions	62
6.7. Loading From A Bank	38	18.2. Skid Steer Tool Carrier Handles In Disengaged Position.....	62
6.8. Peeling And Scraping	39	18.3. Skid Steer Tool Carrier Handles In Engaged Position	63
6.9. Loading Low Trucks Or Spreaders From A Pile	39		
6.10. Backfilling.....	39		
6.11. Handling Large Heavy Objects	40		
6.12. Back Grading	40		
7. Dismounting The Loader	41		
8. Mounting The Loader	45		
9. Optional Grill Guard	48		
9.1. Installation Instructions	48		

19. Installing Bucket Or Attachment To Skid Steer Tool Carrier.....	64	22.4. Operating Instructions.....	70
19.1. Operating Instructions.....	64	23. Skid Steer Pallet Fork	71
20. Removing Bucket Or Attachment From Skid Steer Tool Carrier.....	67	23.1. Skid Steer Pallet Fork.....	72
20.1. Operating Instructions.....	67	23.2. Assembly Instructions.....	72
21. Skid Steer Bucket.....	68	23.3. Installation Instructions To Skid Steer Tool Carrier.....	72
21.1. Skid Steer Bucket	68	23.4. Operating Instructions.....	72
21.2. Installation Instructions To Skid Steer Tool Carrier.....	68	23.5. Parking Instructions	72
22. Skid Steer Bale Spear	69	24. Trouble Shooting Procedures.....	73
22.1. Skid Steer Bale Probe.....	70	24.1. Trouble Shooting For All Loaders	73
22.2. Assembly Instructions.....	70	24.2. Trouble Shooting For Loaders With Optional Self Leveling.....	77
22.3. Installation Instructions To Skid Steer Tool Carrier.....	70	25. Torque Chart.....	78

NOTES:

1. SPECIFICATIONS

**Model ML170
Front End Loader**

**For Use With
Model 7010 Tractor**

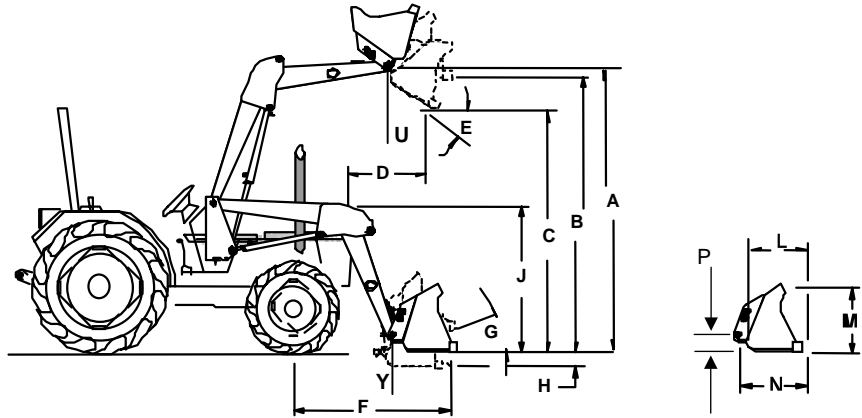

SPECIFICATIONS OF LOADER:	ML170
A. Maximum Lift Height to Pivot Pin	11' 0" (132")
B. Maximum Lift Height under Level Bucket	10' 3" (123")
C. Clearance with Bucket Fully Dumped	8' 6-1/2" (102.50")
D. Reach at Maximum Lift Height (to Grill Guard)	2' 8-3/4" (32.75")
E. Maximum Dump Angle	42 degrees
F. Reach With Bucket on Ground	7' 2" (86")
G. Maximum Rollback Angle	26 degrees
H. Digging Depth	6-1/4"
J. Overall Height in Carry Position	5' 5-1/2"* (65.50")
L. Bucket Depth	25.86"
M. Bucket Height	26.20"
N. Loader Bucket Pin to Front of Front Cutting Edge	33.46"
P. Loader Bucket Pin to Bottom of Front Cutting Edge	9.00"
U. Lift Capacity to Maximum Height at Pivot Pin	3300 lb.
Y. Breakout Force at Ground Line at Pivot Pin	5200 lb.

*Top of Arm at Bucket Pivot Pin with Bucket 12" off ground.

CYCLE TIMES

	1000 RPM	1500 RPM	2000 RPM	2500 RPM
Raising Time Ground Line to Maximum Lift Height	16.5 sec.	11.5 sec.	7.9 sec.	7.2 sec.
Lowering Time Maximum Lift Height to Ground Line	9.6 sec.	9.0 sec.	7.7 sec.	5.2 sec.
Dumping Time Full Rollback to Full Dump without Regen	10.0 sec.	7.8 sec.	5.4 sec.	4.5 sec.
Dumping Time Full Rollback to Full Dump with Regen	6.3 sec.	5.7 sec.	5.0 sec.	4.7 sec.
Rollback Time Full Dump to Full Rollback	7.0 sec.	5.6 sec.	3.5 sec.	3.1 sec.

Lift Cylinder Dia.	3"
Tilt Cylinder Dia.	2-1/2"
Tire Sizes (specifications taken with)	Front: 9.5Lx15 Rear: 16.9x28
Relief Valve Setting (Loader Valve) w/o Hyd. Self Level	2600 psi
Relief Valve Setting (Loader Valve) with Hyd. Self Level	2600 psi

Specifications taken with Mounting Kit, Hose Kit, and 78" Pin On Standard Bucket.
Specifications based on ASAE standards S301.3 and furnished for general information only as they can vary with different tractor models. Specifications are subject to change without notice and without liability therefore.

1.1. ATTACHMENT SPECIFICATIONS

BUCKET 78" Pin On Material	STRUCK CAPACITY 18.59 cu. ft.	RATED SIZE CAPACITY 22.82 cu. ft.
-------------------------------	----------------------------------	--------------------------------------

2. INTRODUCTION

This manual provides safety, installation, operation, maintenance, removing, storing, and reinstalling instructions for your new mid-mount loader.

Your loader has been designed to give many years of satisfactory service. Successful operation and long life of the loader depends, of course, on proper operation and care. Please read this manual carefully and follow the instructions. Correct operation and maintenance will save much time and expense.

OBSERVE and follow all CAUTION, WARNING, and DANGER instructions to help prevent personal injury and damage to the loader. The reference to right hand (RH) and left hand (LH) used in this manual refers to the position when standing at the rear of the unit and facing forward.

If, at any time, you have a service problem with your loader or need new parts, contact your local Mahindra dealer. Your dealer will need the loader model number and serial number to give you prompt, efficient service. The serial number plate is located on the LH inside front area of boom.

	KM/Ltd P.O. Box 207 Bilaspur, Chh. Pr. India - 491 001
Model No	_____
Serial No	_____



Before operating loader, check that your Dealer has covered the following information with you:

- _____ Equipment has been completely assembled as directed.
- _____ Equipment has been functionally tested for proper operation.
- _____ Purchaser has been instructed in proper & safe operating methods:
 - _____ Operators Safety Precautions
 - _____ Tractor Wheel Tread-Tire & Inflation Recommendations
 - _____ Tractor Hydraulic System & Loader Controls
 - _____ Rear Ballast Recommendations
 - _____ Hydraulic System Oil Level
 - _____ Proper Loader Operation
 - _____ Loader Removal
 - _____ Loader Installation
 - _____ Lubrication - Service Care
 - _____ Storage
- _____ Warranty Coverage & Operators Manual explained to purchaser.

Mahindra ML170 Loader Serial Number Information

LOADER SERIAL NUMBER _____

DATE PURCHASED _____

DEALER NAME _____

AND TELEPHONE NUMBER _____

3. INSTALLATION INSTRUCTIONS



CAUTION: Equip your tractor with a ROPS cab or frame for your protection. See your tractor/ROPS Operator Manual for correct seat belt usage.

Read entire instructions before beginning to install the loader. Personal injury and machine damage may be prevented if you read and understand these instructions and special safety messages.

When you are in the tractor seat looking forward, the RH and LH sides of the tractor and loader are the same as your right hand and left hand.

3.1. TRACTOR PREPARATION

3.1.1. Tractor Front Tires

Use front tires of equal size and maintain equal pressure in each tire. The pressure of the front tractor tires must be increased to the maximum approved pressure recommended by the tire manufacturer to compensate for additional load placed on the tires with the Front End Loader. See your tractor Operator Manual. Adjust the front tires to the widest recommended setting on adjustable models for maximum stability. Front end weights must NOT be used while loader is on the tractor.

3.1.2. Tractor Rear Tires

Maintain equal pressure in each of the rear tires. Use the widest recommended rear wheel setting for maximum stability.

3.1.3. Tractor Ballast



CAUTION: To help prevent rollover, use recommended rear tractor ballast and widest wheel settings to maximize stability. See your tractor Operator Manual for recommendations

Front tractor weights must only be used when the loader is parked. Weights must be removed before remounting loader or serious damage will occur to loader or tractor front axle due to excessive weight.

The use of adequate rear counterweight to counterbalance for maximum loader capacity is required for safe loader operation. Weight added to the rear of the tractor provides better traction and easier, more efficient loader operation.

IMPORTANT: Do not exceed the maximum load capacity of the tires on your tractor. See Tire and Wheel Specifications in tractor Operator Manual for more information.

3.1.4. Remove all loader components from shipping packaging.



WARNING: To avoid serious injury or death: Read before cutting bands or removing attaching straps. The loader may shift during shipping and handling, making it unstable on the pallet. Support loader with an overhead hoist or other suitable means prior to removing bands or attaching straps securing loader to pallet. Failure to do so could result in accidental tip-over of the loader that could cause serious injury to you and/or bystanders.



CAUTION: Lift and support all loader components safely.

3.2. MOUNTING KIT INSTALLATION

3.2.1. Position the tractor and loader on a hard level surface under a hoist.

3.2.2. Remove front weights from tractor.

IMPORTANT: Do not tighten any hardware until all components are attached onto the tractor.



CAUTION: Lift and support all loader components safely.

3.2.3. Check right hand side of tractor in front axle area. Reposition components as shown so they will clear loader bracket.

Reposition components



3.2.4. Position hoist with chain through center bracket hole to support bracket during installation.

Position hoist with chain through this hole when mounting center bracket.

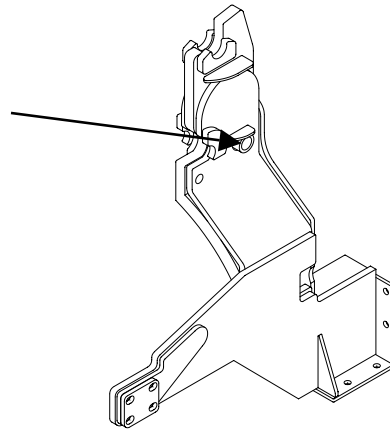

3.2.5. With hoist supporting center bracket, locate oscillation stop with tab under and toward front of tractor and 1/2" thick 4-hole spacer between center bracket and tractor. Install 16mm x 2.0P x 90mm hex bolts Grade 10.9, 5/8" lockwashers, and 5/8" flatwashers, 4 places. Do not remove hoist.

Oscillation Stop

Spacer, 4-Hole

**16mm x 2.0P x 90mm Grade 10.9 Hex Bolt,
5/8" Lockwasher, and 5/8" Flatwasher,
4 places.**

Center Bracket

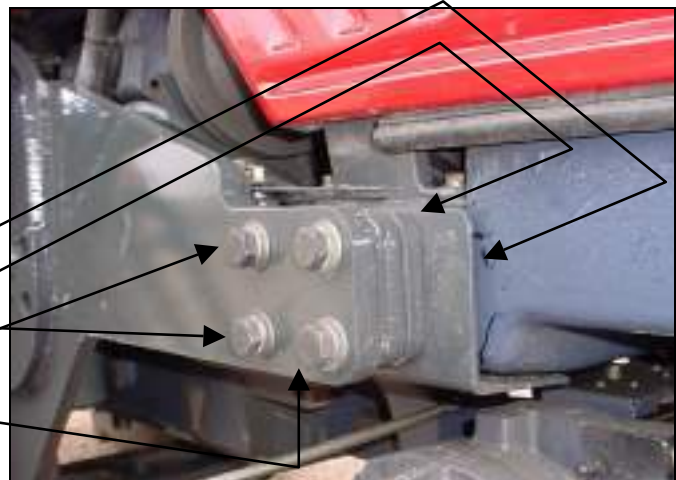

3.2.6. With hoist supporting center bracket, install 16mm x 2.0P x 30mm Grade 8.8 hex bolts and 5/8" lockwashers, 2 places inside and 2 places outside of bracket in front area of cab. Do not remove hoist.

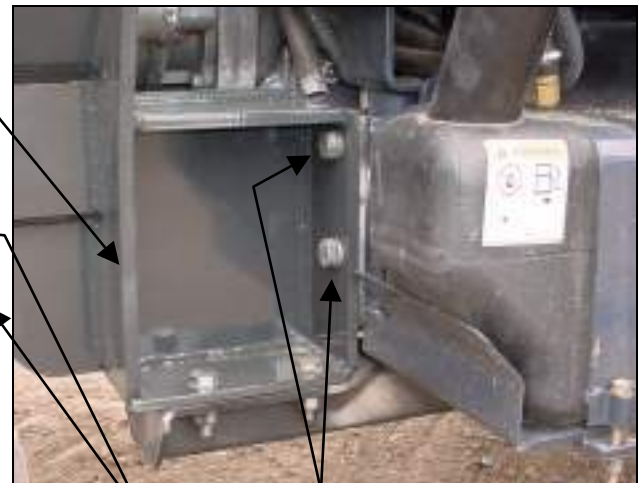
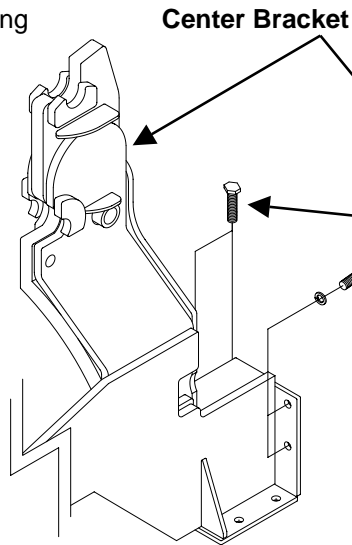

16mm x 2.0P x 30mm Grade 8.8 Hex Bolt and 5/8" Lockwasher, 2 places inside (shown in illustration) and 2 places outside (shown in photo).

3.2.7. From rear axle, remove inside set of bolts and lockwashers securing 3-point components to rear axle. Save hardware.

Position of bolts to be removed one on each side of axle.

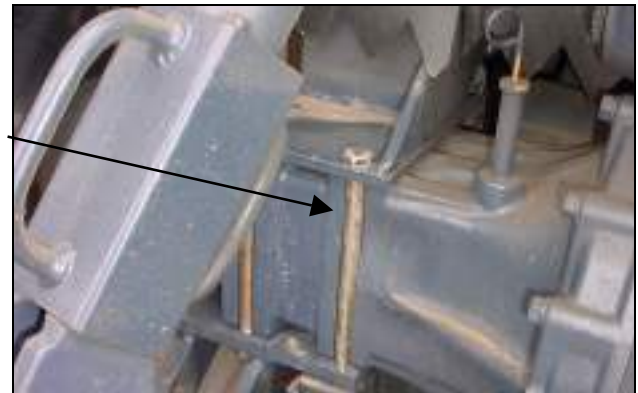

3.2.8. Install rear rail to center bracket using 5/8" x 1-3/4" hex bolts Grade 5, lockwashers, and hex nuts, 2 places outside only.

Center Bracket
5/8" x 1-3/4" Hex Bolt Grade 5,
5/8" Lockwasher, and 5/8" Hex Nut.
2 places outside only.
Rear Rail



3.2.9. Install rear rail to rear axle as shown re-using bolts and lockwashers just removed along with 1/2" flatwashers included with mounting kit.

Position of bolts previously removed.

Tractor Bolt and Lockwasher along with Mounting Kit 1/2" Flatwasher, 2 places each side

Rear Rail, 1 place each side

3.2.10. Remove hoist from center bracket.

3.2.11. Install opposite brackets using previous instructions.

3.2.12. Install crossbrace to RH and LH center brackets using 5/8" x 2" hex bolts Grade 5, lockwashers, flatwashers, and hex nuts, 2 places Inside only.

RH Center Bracket

**5/8" x 2" Hex Bolt Grade 5,
5/8" Lockwasher, and 5/8" Hex Nut,
2 places each side inside only**

RH Rear Rail

Crossbrace

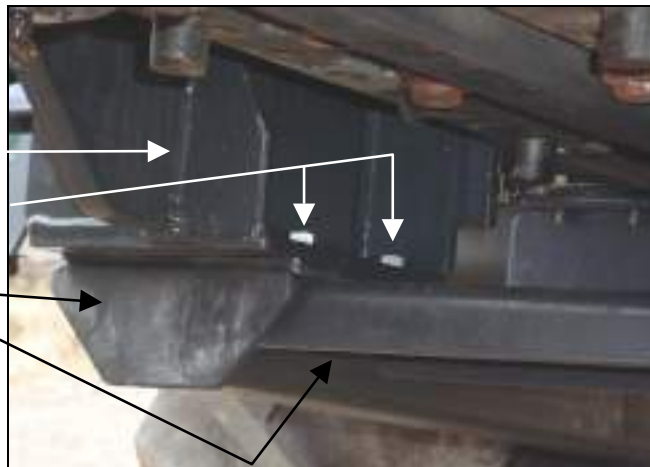
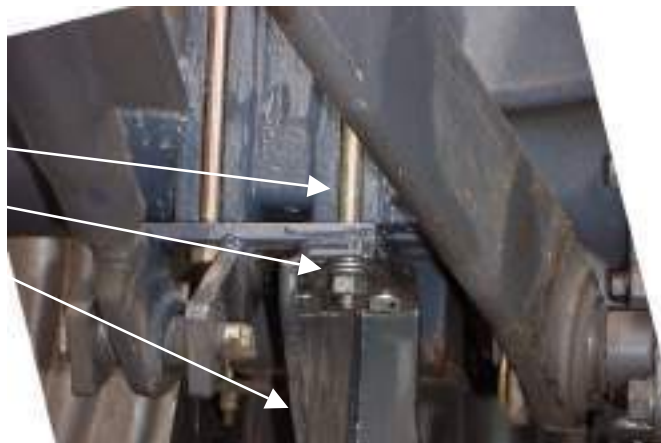

3.2.13. *Reference Photo:*

5/8" x 1-3/4" hardware, securing rear rail to center bracket is located in outside 2 holes.

5/8" x 2" hardware, securing crossbrace and rear rail to center bracket is located in inside 2 holes.

RH Rear Rail

Crossbrace

**5/8" x 2" hardware,
inside 2 holes each side**

LH Rear Rail

**5/8" x 1-3/4" hardware,
outside 2 holes each side**



NOTE: Do not tighten any of the crossbrace hardware until all other mounting bracket hardware is torqued to specifications.

CRITICAL: Torque all mounting kit hardware.

- A. Identify hardware size and grade.
- B. Refer to Torque Chart, page 78 and find correct torque for your hardware size and grade.
- C. Torque hardware to this specification unless otherwise specified.

IMPORTANT NOTE: To keep mounting kit hardware from loosening during loader operation, hardware must be torqued to specifications.

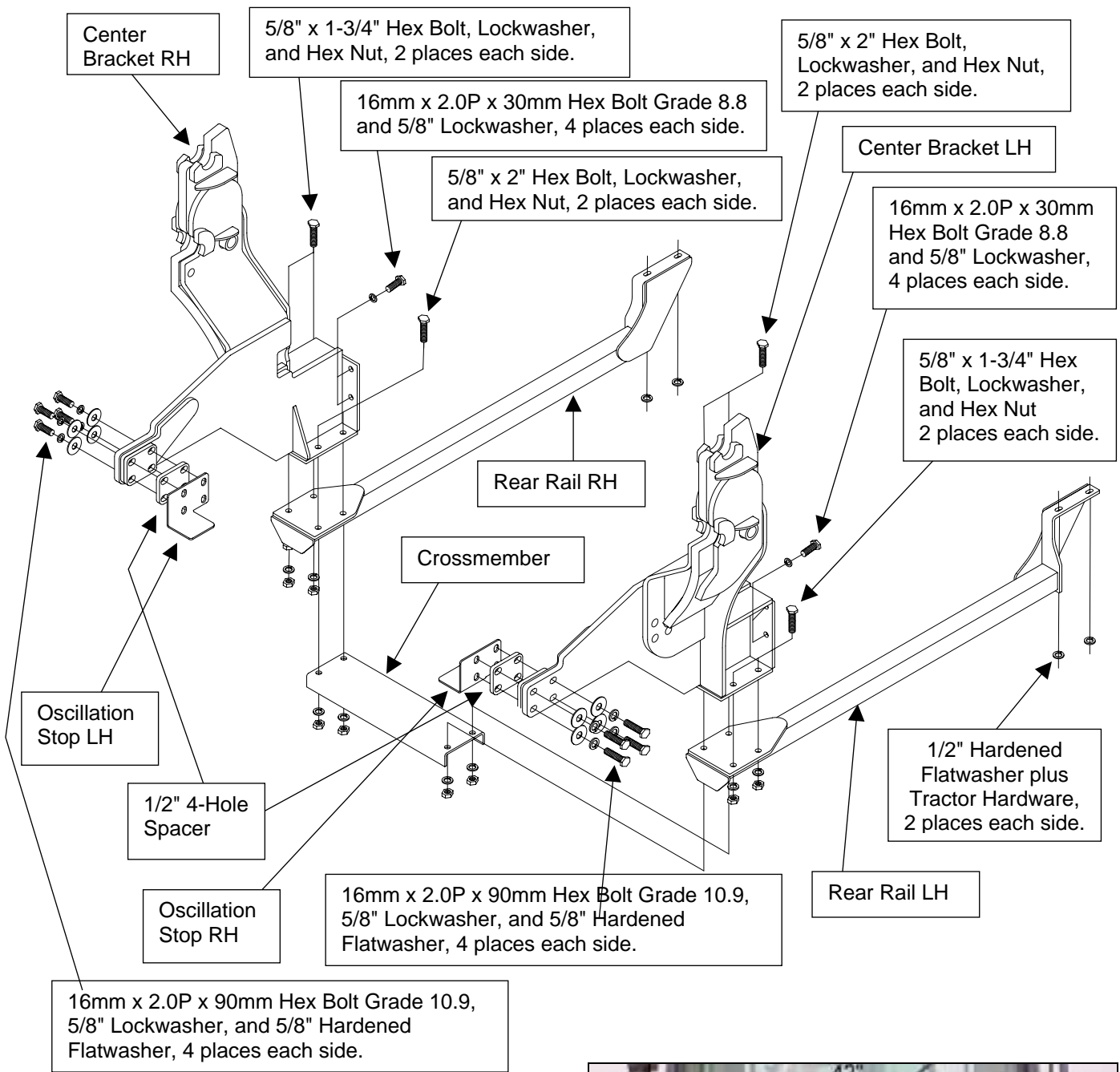

3.2.14. Verify outside surface of brackets are level and the centerline measurement from RH to LH towers reads 42" plus or minus 3/8".



3.3. HYDRAULIC INSTALLATION

3.3.1. Remove RH cab console components to reveal existing console bracket. Save console components and console hardware.

RH Cab Wall
Existing Console Bracket
(installed on tractor).

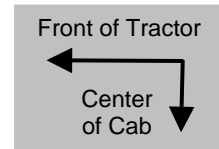
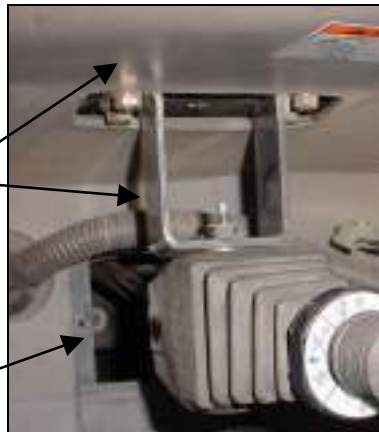

3.3.2. Remove RH cab floor plate cover to reveal opening to outside of cab. Save floor hardware.

Cab Floor Opening.

3.3.3. Peel rubber boot back from controller to expose controller linkage. Position single lever controller with cables so solid post is positioned toward front and center of tractor.

Float part of decal faces toward front of tractor.

Rubber Boot, in raised position.

Lift Cable controls Raise & Lift functions of Loader.

Solid post positioned toward front and center of tractor.

Single Lever Controller.

8mm x 80mm Hex Bolt Grade 10.9 and 5/16" Lockwasher, 2 places.

Tilt Cable controls Dump & Rollback functions of Attachment.

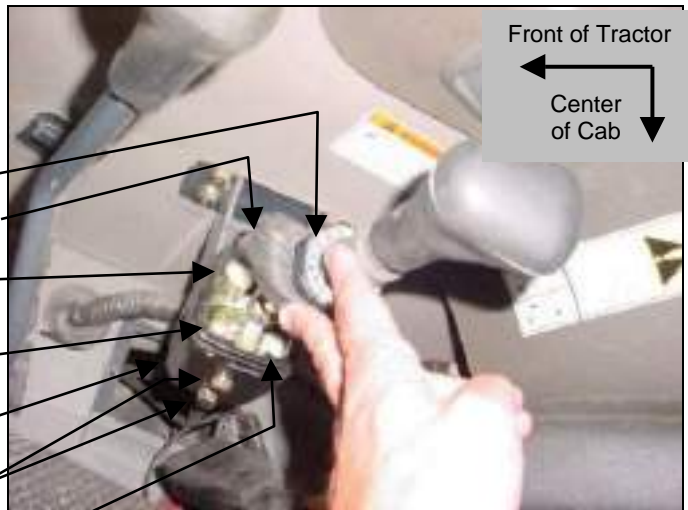

3.3.4. Install single lever controller to existing console bracket using 8mm x 80mm hex bolts Grade 10.9 and 5/16" Lockwashers.

Existing Console Bracket
Two 5/16" spacer flatwashers
on top bolt only.

Single Level Controller
with pre-assembled Cables.

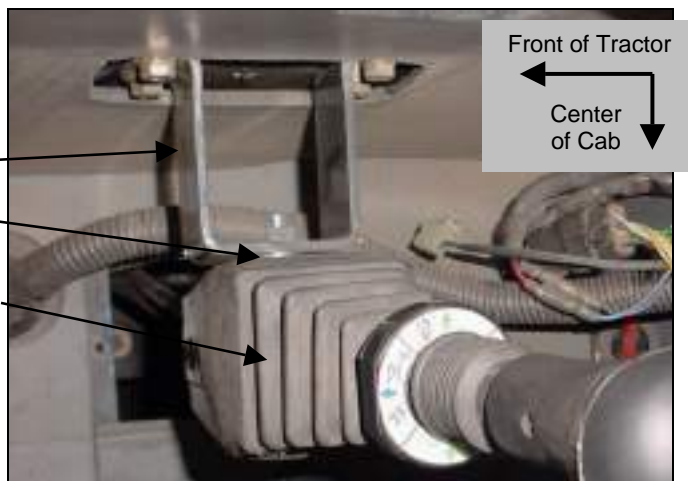

IMPORTANT NOTE: Two flatwashers must be used on top bolt between controller and console bracket to tilt handle toward operator. Do not use flatwashers on bottom bolt.

Two 5/16" spacer flatwashers on top bolt only.
No Flatwashers on bottom bolt.
Existing Console Bracket
Single Level Controller

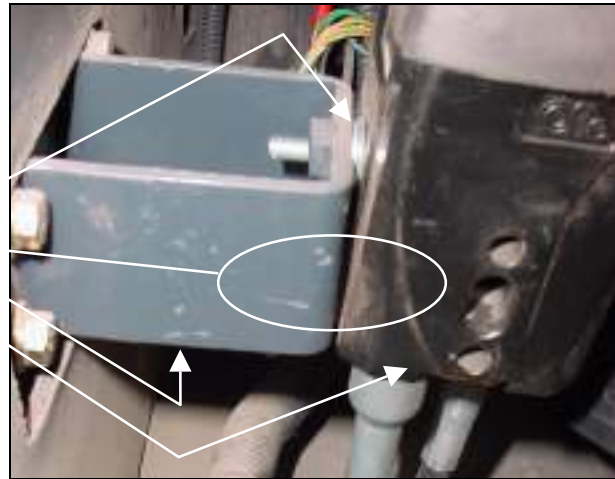

3.3.5. Route cables down through cab floor opening. Install new triangle floorboard plates around cables re-using floor hardware just removed.

Triangle Floorboard Plates.
Re-use floor hardware.

3.3.6. Apply silicone sealant around cables and between triangle plates to reduce air and dust leaks.

Silicone sealant must be supplied by installer.

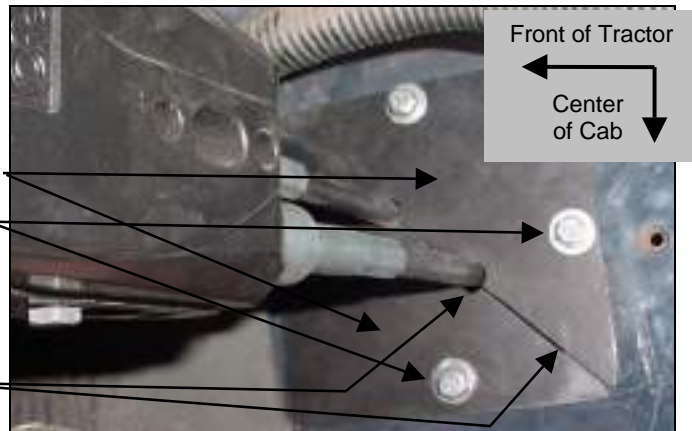

3.3.7. Reposition rubber boot over single level controller.

Rubber Boot repositioned.

3.3.8. Reinstall cab console components and secure using console hardware.

Cab Console Components Reinstalled

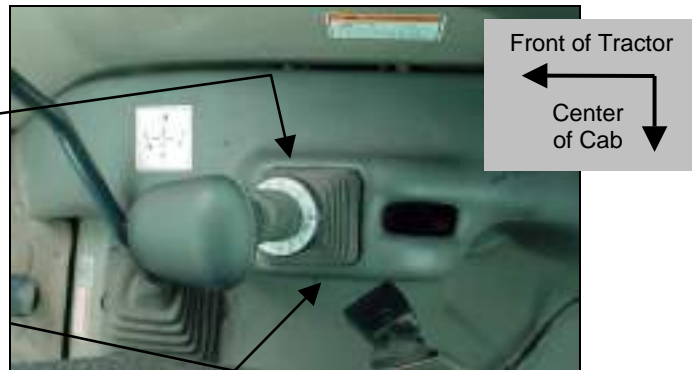

3.3.9. Remove RH cab step. Save step and step hardware.

RH Cab Step



3.3.10. From RH side of tractor underneath cab, remove hydraulic hose connecting tractor pressure port to tractor power beyond port. Keep tractor fittings in place.

Tractor Power Beyond Port Location.

Tractor Hose – Remove.

Tractor Fittings – Do Not Remove.

Tractor Pressure Port Location.

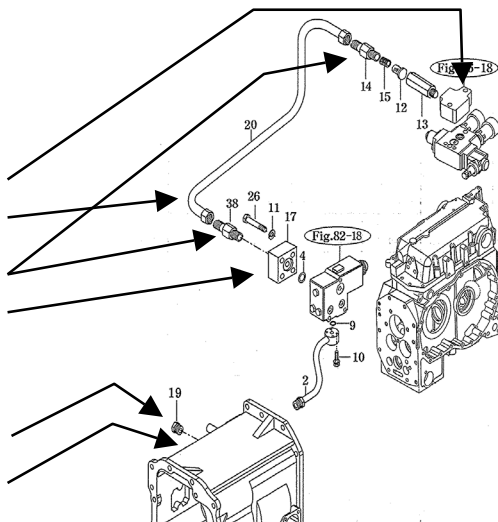

3.3.11. Remove plug from tractor transmission port.

Tractor Plug – Remove.

Tractor Transmission Port

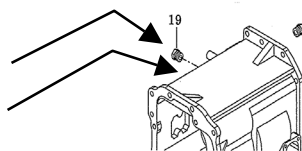

3.3.12. **Pressure "IN" Line:** Install 17" hose to tractor straight fitting in tractor pressure port.

Tractor Pressure Port

Tractor Straight Fitting

Hose 1/2" x 17"
BSPP F 1/2" 90° x JICF 3/4"

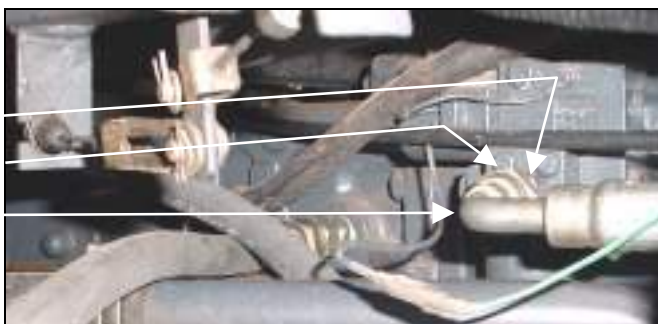

3.3.13. **Return "OUT" Line:** Install fitting and 25" hose to tractor return port.

Tractor Return Port

Fitting Straight
BSPT F 1/2" x JIC M 7/8"

Hose 1/2" x 25"
JICF 7/8" X JICF 3/4" 90°

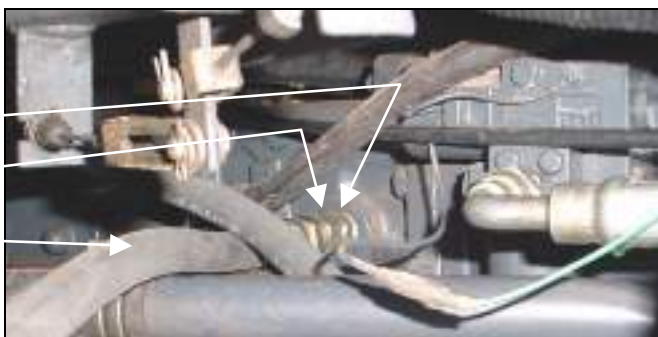

3.3.14. **Power Beyond Line:** Install 60" hose to tractor straight fitting in tractor power beyond port.

Tractor Power Beyond Port

Tractor Straight Fitting

Hose 1/2" x 60"
BSPT M 1/2" 90° x JICF 3/4"

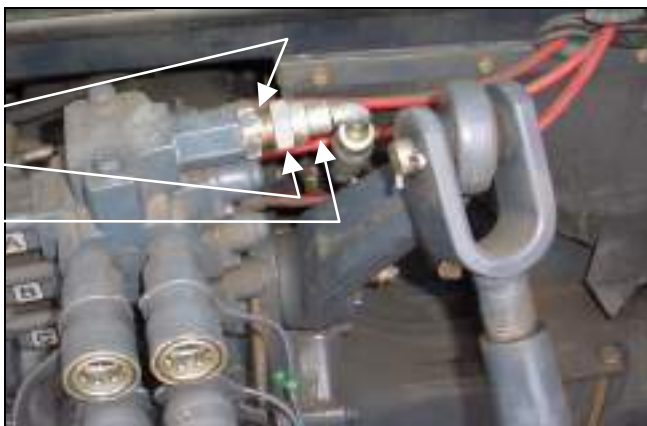

NOTE: Do not start tractor engine until these hoses are installed and secured to the loader valve.

3.3.15. **Loaders That Are Not Equipped With Hydraulic Self Leveling:** Rotate loader valve so that Port "D" is upward. Install orifice fitting by dropping it into Port "D" with slot of orifice facing upward. Screw fitting into Port "D" to secure orifice into port. (Do not install orifice on Loaders equipped with Hydraulic Self Leveling.)

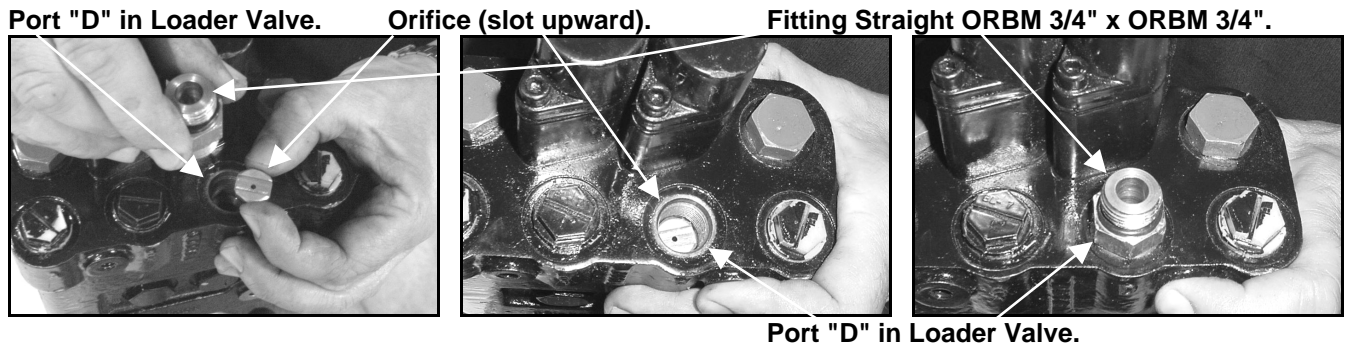

3.3.16. Install fittings to valve as follows:

Power Beyond side of valve.

- Port "C" Tilt Cylinder Base End
Yellow Tie
- Port "D" Tilt Cylinder Rod End
Red Tie
- Port "B" Lift Cylinder Rod End
Blue Tie
- Port "A" Lift Cylinder Base End
Green Tie

NOTE: Do not tighten power beyond or pressure hose until they are connected to tractor.

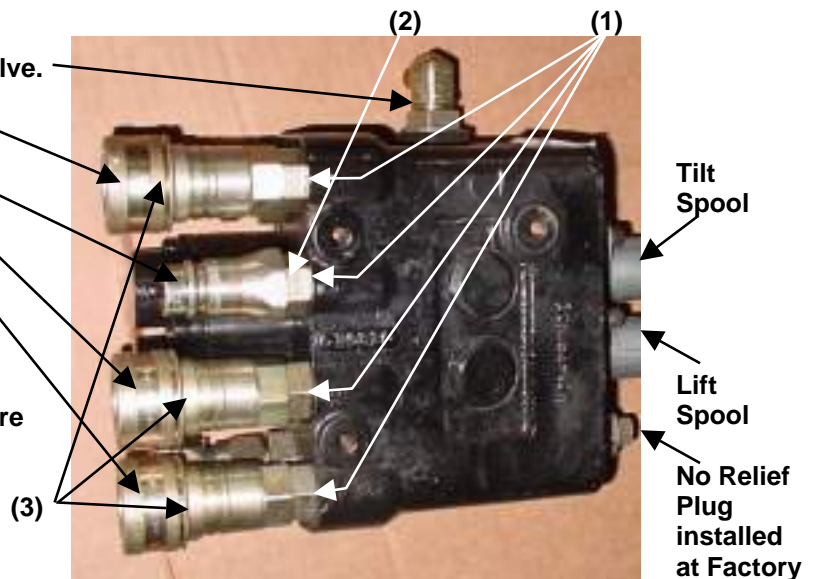

(1) **Port "A", "B", "C", & "D":** Install Fitting Straight ORBM 3/4" x ORBM 3/4".

(2) **Port "D":** Install Male Quick Coupler, only into Port "D".

(3) **Port "A", "B", & "C":** Install Female Quick Coupler, into remaining three ports.

(4) **Power Beyond Port:** Install Fitting 90° JICM 3/4" x ORBM 3/4".

(6) **Return "OUT" Port:** Install Fitting Straight JICM 3/4" x ORBM 7/8".

(7) **Pressure "OUT" Port:** Install Fitting 90° JICM 3/4" x JICF 3/4".

(8) **Pressure "IN" Port:** Install Fitting Straight JICM 3/4" x ORBM 7/8".

(9) **Pressure "IN" Port:** Install Fitting 90° JICM 3/4" x JICF 3/4".

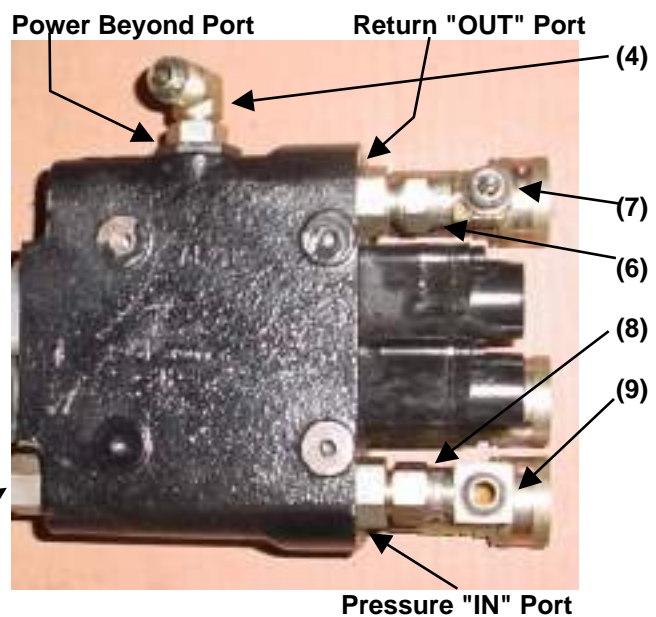

No Relief Plug installed at Factory

3.3.17. Install valve mount to tractor mount located under RH side of cab behind cab step that was just removed. Secure using 8mm x 20mm hex bolt and 5/16" lockwasher, 3 places.

Valve Mount
8mm x 1.25P x 20mm Hex Bolt
and 5/16" Lockwasher,
3 places.
Tractor Mount

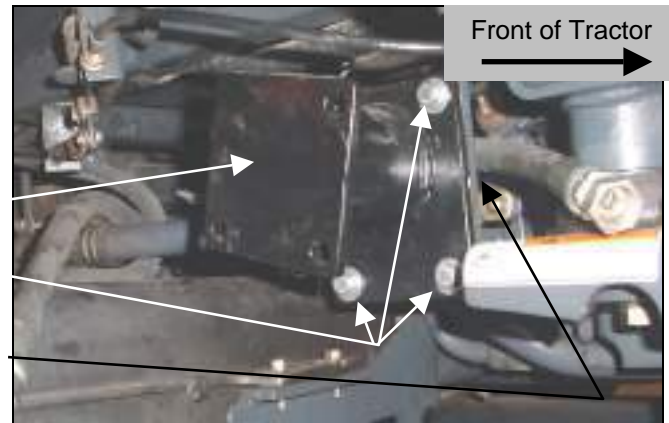

3.3.18. Install valve to valve mount under RH side of cab using 5/16" x 1" hex bolt and 5/16" lockwasher, 3 places.

Valve
5/16" x 1" Hex Bolt
and 5/16" Lockwasher,
3 places.
Valve Mount

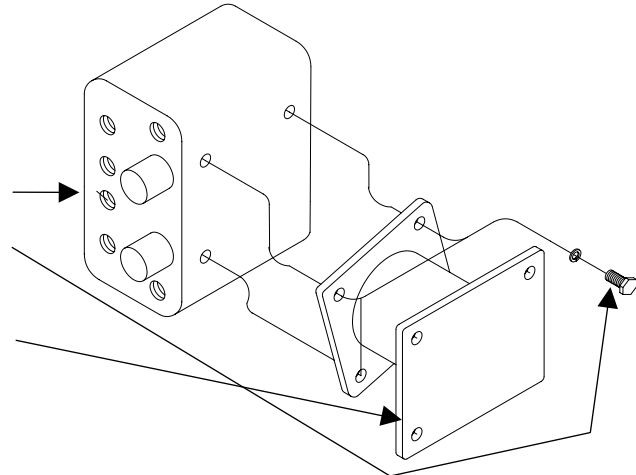

3.3.19. Identify and trace cables from Single Lever Controller.

Raise and Lower (Lift) Cable is Frontward Cable

Dump and Rollback (Tilt) Cable is Rearward Cable

3.3.20. Install raise and lower (lift) cable to upper spool of valve and dump and rollback (tilt) cable to lower spool of valve as follows. Refer to photo and illustration following.



- A. Thread large jam nuts entire length of threaded hubs and onto cables.
 - B. Place dual flange over both cables.
 - C. Thread sleeves entire length of threaded hubs and onto cables.
 - D. Thread small jam nuts onto cable threaded rods until they bottom out on threads.
 - E. Place connectors onto threaded rods and against jam nuts. Align connectors so they will mate with spool terminal eyes and secure jam nuts against connectors.
 - F. Slide connectors onto spools and align the holes. Insert pins through connectors and spool holes.
 - G. With cables attached to valve and single handle controller, turn the sleeves onto threaded hubs until they are flush with the valve face.
- NOTE: When turning the sleeves, make sure the single handle controller remains in the neutral position.
- H. Tighten large nuts against sleeves to lock in position.
 - I. Slide dual flange into position and secure using socket head cap screws and flatwashers.



Install Dump and Rollback (Tilt) Cable to Lower Spool of Valve

Install Raise and Lower (Lift) Cable to Upper Spool of Valve

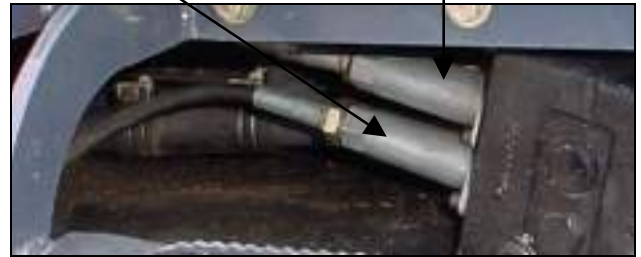

NOTE: Over-tightening will distort flange.

NOTE: Controller handle can be repositioned slightly by tightening or loosening sleeves.

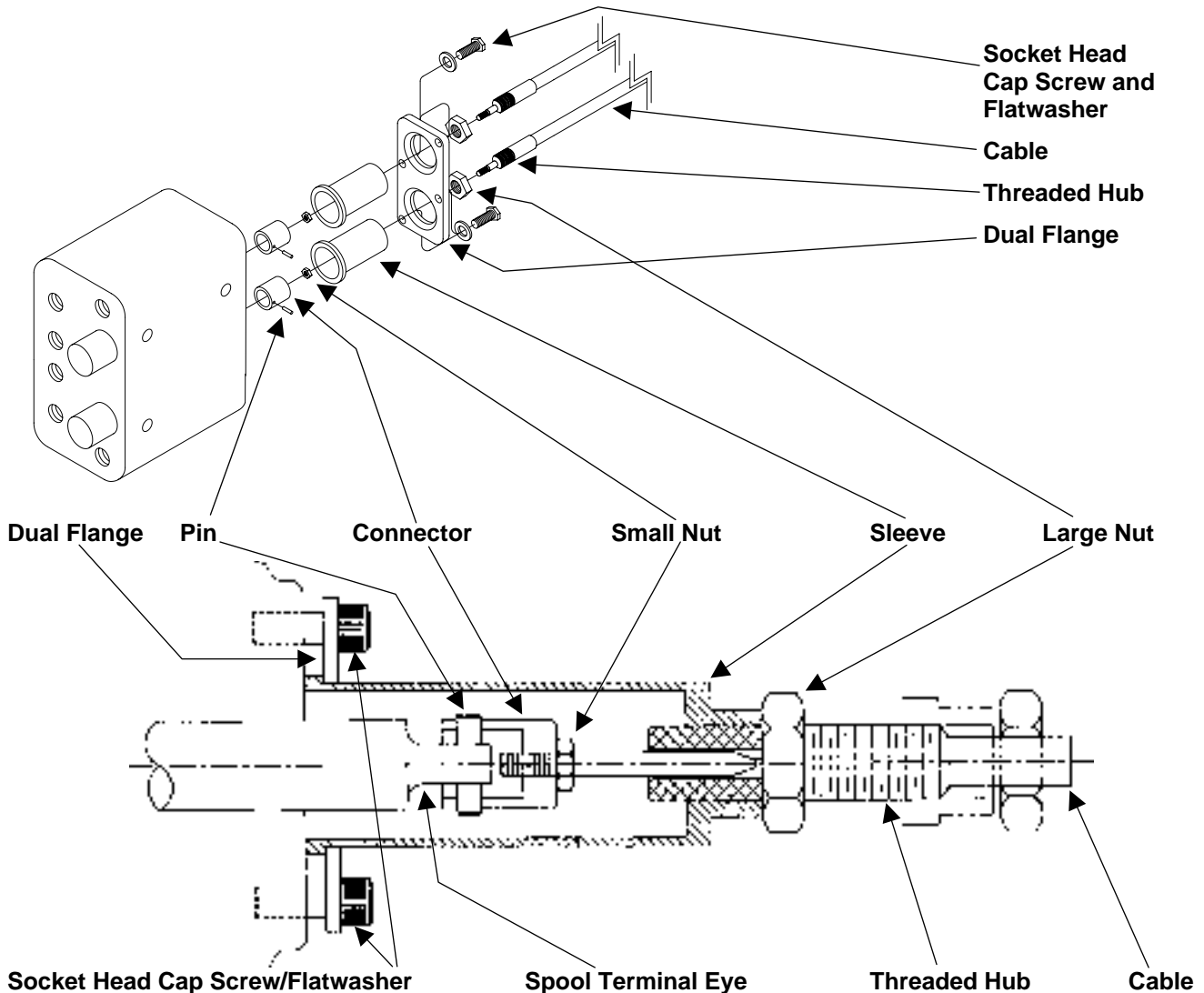

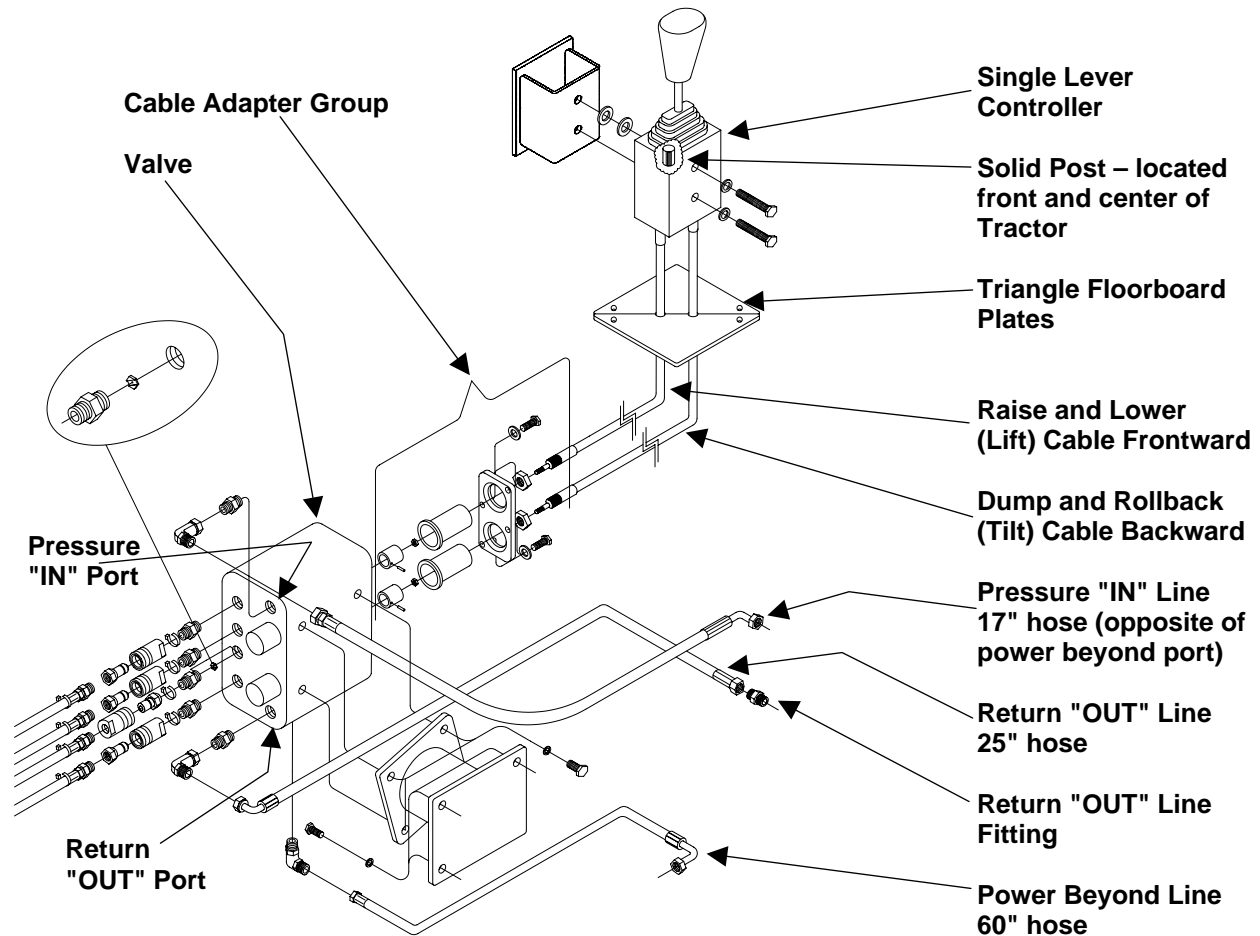

3.3.21. Route 17" pressure hose to fittings in pressure port of valve.

17" Pressure Hose

3.3.22. Route 25" return hose to fittings in return port of valve.

25" Return Hose

3.3.23. Route 60" power beyond hose to fitting in power beyond port of valve.

60" Power Beyond Hose

3.3.24. Remove all twists from hoses then tighten hydraulic connections.

3.3.25. Check that all hydraulic connections have been tightened.

3.3.26. Reinstall RH cab step reusing cab step hardware.

- Cab Step Hardware**
- Raise and Lower (Lift) Cable**
- Dump and Rollback (Tilt) Cable**
- RH Cab Step**

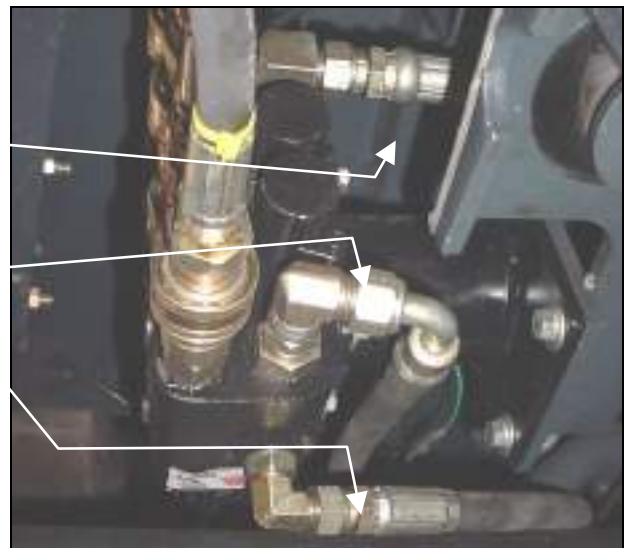

3.4. LOADER INSTALLATION

3.4.1. Remove all loader components from shipping package.



CAUTION: Lift and support all loader components safely.

IMPORTANT: Do not extend tilt cylinders without attachment pinned to loader. Failure to follow these instructions could cause loader damage and void warranty.

3.4.2. Loader valve hoses and quick couplers have been pre-assembled on loader. Unwrap these hoses by cutting nylon ties securing them to side of loader.

3.4.3. Before installing loader to tractor, use a hoist to install pin on bucket or pin on attachment and bucket or skid steer attachment and bucket on loader. Secure using pins and e-clips, 4 places.

**Top Pin 1-1/8" x 7.01",
Grease Fitting 1/4"-28 and E-Clip,
1 place each side.**

**Bottom Pin 1-1/8" x 7.01",
Grease Fitting 1/4"-28 and E-Clip,
1 place each side.**

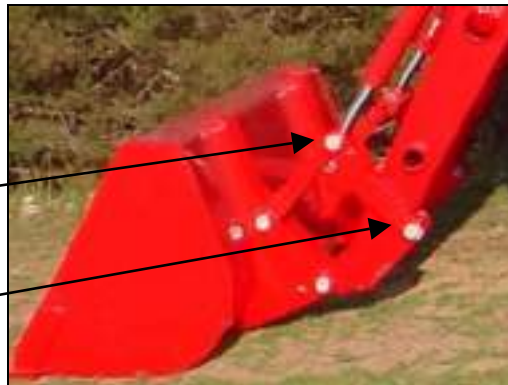

Refer to Section 10 for Pin On Bucket, page 49.

Refer to Section 11 for Pin On Bale Spear, pages 50 to 51.

Refer to Section 12 for Pin On Pallet Fork, pages 52 to 53.

Refer to Sections 13 to 16 for Optional Pin On Quick Attach System, pages 54 to 59.

Refer to Sections 17 to 20 for Optional Skid Steer Tool Carrier System, pages 60 to 67.

3.4.4. Following these instructions will add stability to loader package and will allow easier handling of loader with hoist.

3.4.5. Support the loader by using a hoist. Install loader to mounting brackets previously installed on tractor.

Refer to Section 8 — Mounting the Loader, pages 45 to 47.



CAUTION: Lift and support all loader components safely.

3.5. CONNECT HYDRAULICS

3.5.1. Verify all working port hose connections.

- (C) Connect Port "C" to Tilt Cylinder Base End
- (D) Connect Port "D" to Tilt Cylinder Rod End
- (B) Connect Port "B" to Lift Cylinder Rod End
- (A) Connect Port "A" to Lift Cylinder Base End

- (1) "PBY" Power Beyond Port.
- (2) "OUT" Return Port.
- (3) "IN" Pressure Port.
- (4) Loader Valve.

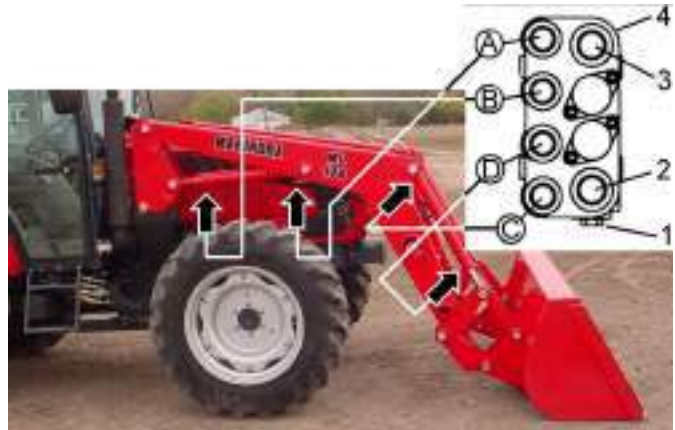

3.5.2. Using color nylon ties, install one on each quick coupler fitting. These color ties will allow easy identification of loader circuits when mounting and dismounting loader.

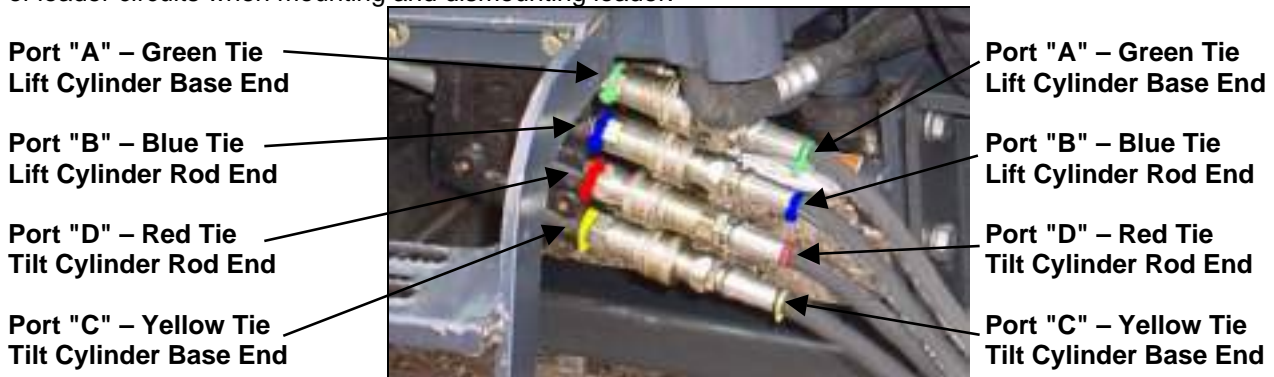

IMPORTANT: Valve Port "C" must be connected to Tilt Cylinder Base End port and Valve Port "D" must be connected to Tilt Cylinder Rod End port or else Regen Function of Valve will not work correctly.

CAUTION: When properly installed, the external valve handle will control loader hydraulic circuits as described in Item 4.4, page 32.

3.6. BUCKET LEVEL INDICATOR

3.6.1. Install bucket level indicator rod assembly into bucket level indicator tube assembly.

3.6.2. Attach bucket level indicator tube assembly to base end of RH tilt cylinder using 5/16 x 1-1/2" hardware.

3.6.3. Attach bucket level indicator rod assembly to rod end RH tilt cylinder using 5/16" x 1/2" hardware.

3.6.4. Adjust bucket level tube for proper alignment with bucket level rod by sliding slotted bracket to desired position and tightening bolt.

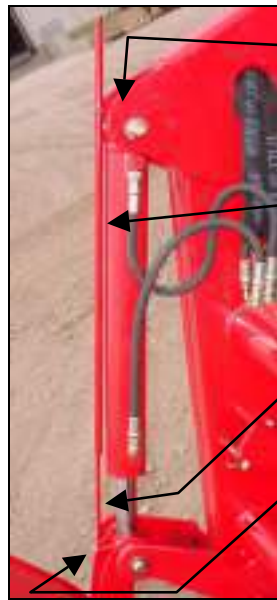

Hex Bolt 5/16" x 1-1/2" Grade 5, 5/16" Lockwasher, and 5/16" Flatwasher

Bucket Level Indicator Tube Assembly

Bucket Level Indicator Rod Assembly

Hex Bolt 5/16" x 1/2" Grade 5 and 5/16" Lockwasher

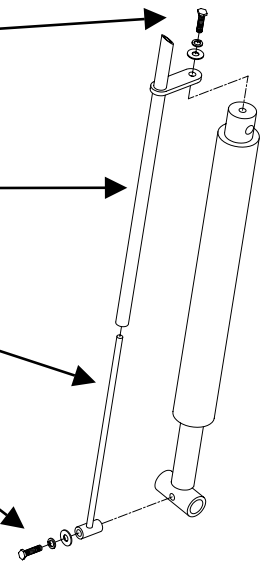

3.6.5. After installing loader on tractor, position loader on ground with bucket flat, then paint or mark end of bucket level indicator rod so operator can identify when bucket is level on ground.

Paint or mark end of BLI rod.



3.7. STEERING STOP

3.7.1. Set steering stop out to a maximum of 29/32" between top of nut and top of bolt head.



4. PRE-OPERATION INSTRUCTIONS

4.1. HYDRAULIC FLUID

Check the tractor hydraulic fluid level and fill, if required.

4.2. INITIAL LOADER OPERATION

NOTE: If any loader cavitation is noticed during loader operation, check tractor hydraulic fluid level and correct.

NOTE: Keep engine speed at low idle during the initial loader operation.



CAUTION: Escaping hydraulic fluid under pressure can have sufficient force to penetrate skin, causing serious personal injury. Before disconnecting lines, be sure to relieve all pressure.

Before applying pressure to system, be sure all connections are tight and that lines, tubes, and hoses are not damaged.

Fluid escaping from a very small hole can be almost invisible. Use a piece of cardboard or wood, rather than hands, to search for suspected leaks.

If injured by escaping fluid, see a doctor at once. Serious infection or reaction can develop if proper medical treatment is not administered immediately.

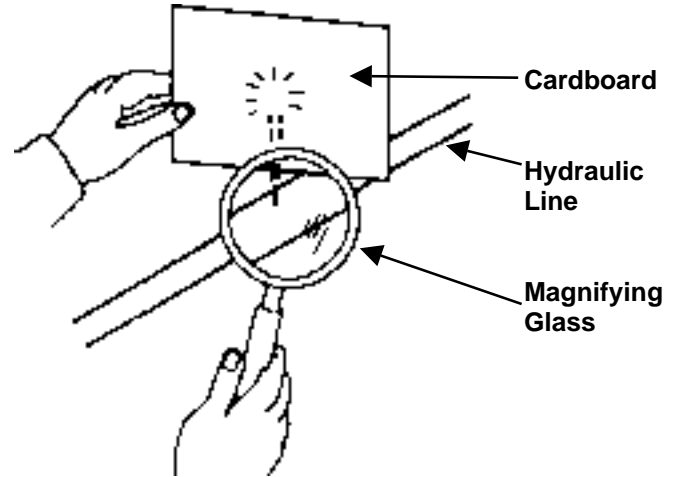

4.3. EXTERNAL LOADER VALVE



CAUTION: When properly installed, the loader valve handle will control loader hydraulic circuits as described below.

IMPORTANT: Contaminants in hydraulic fluid can cause valve spools to stick. **BE ALERT** when operating loader and follow your tractor Operator Manual hydraulic fluid maintenance schedule.

4.4. LOADER MOUNTED VALVE EQUIPPED WITH SINGLE HANDLE CONTROLLER ON A LOADER NOT EQUIPPED WITH HYDRAULIC SELF LEVEL OPTION

4.4.1. **LOADER WITHOUT SELF LEVEL VALVE:** Your loader utilizes a loader mounted valve equipped with single handle control and it will function as described.

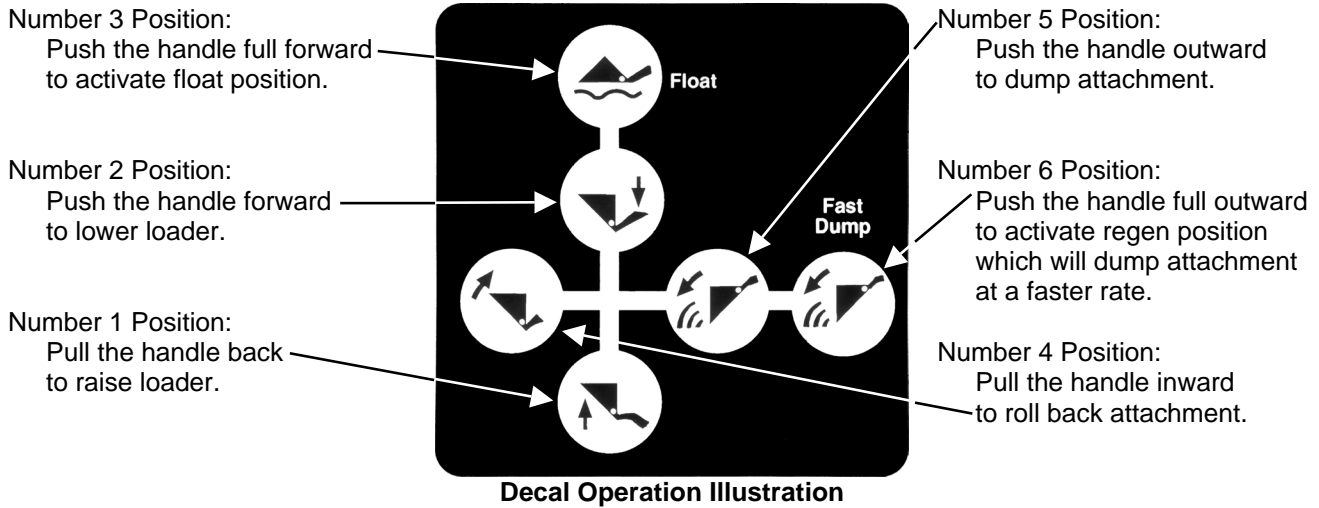

View of Decal from front side of handle

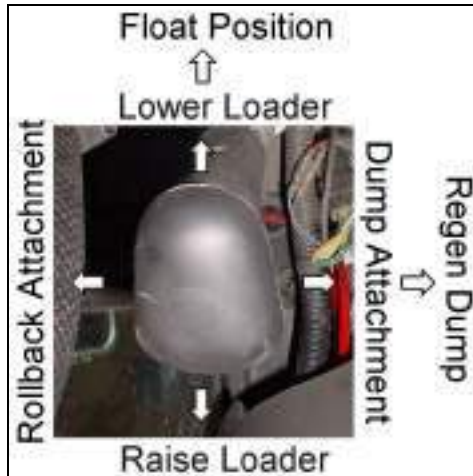

View of Decal from back side of handle

Controller Collar

4.5. NEUTRAL POSITION

The loader external valve has a "neutral position" which prevents movement of the loader or attachment. When the valve handle is manually released from the work position, the valve spool will return to the neutral position.

4.6. NEUTRAL LOCK POSITION

Push collar down to lock controller into neutral position — Red button is out when neutral position is locked.
Lift collar up to unlock controller from neutral position — Green button is out when neutral position is unlocked.

4.7. FLOAT POSITION

The loader valve has a "float position" incorporated into the lift cylinder circuit which allows the loader to float. This float feature is important for satisfactory operation when scraping, sweeping, leveling, or any job where it is necessary to follow the contour of the surface. To activate float position, lower the bucket or attachment and push the valve handle all the way forward into detent. The valve will stay in float detent position until the operator manually pulls the valve handle out of detent position to deactivate float.

4.8. REGENERATIVE DUMPING POSITION

The loader valve has a "Feel Position Regenerative Spool" incorporated in the attachment spool. The tilt cylinders must be connected to this spool allowing the operator to choose normal dump or fast dump during loader operation.

NOTE: Use normal dump position when digging with loader. This will allow operator to put full tractor weight on cutting edge during this operation. The regenerative function can then be used when dumping load from bucket.

NOTE: Valve circuits must be hooked up correctly to allow regen to operate correctly.

IMPORTANT: If the bucket or attachment does not operate as indicated on the directional decal, lower the bucket to the ground, stop the engine, and relieve all hydraulic pressure. Recheck hydraulic circuits hookup to loader valve and correct.

NOTE: Use of regen function during dumping will eliminate attachment cylinder cavitation, which will reduce or eliminate any free movement of bucket or attachment during loader operation.



CAUTION: Do not tamper with relief valve setting. The relief valve is pre-set at the factory. Changing the setting can cause overloading of the loader and tractor, which may result in serious injury.

4.9. INITIAL LOADER OPERATION

NOTE: Keep engine speed at low idle during the initial loader operation.

Before operating the loader, fully raise and lower the boom two or three times. Then raise the loader bucket approximately four (4) feet above the ground and cycle the tilt cylinders two or three times. Lower the bucket or attachment to the ground. Check the tractor hydraulic fluid level and fill as required. Refer to the tractor Operator Manual for the proper hydraulic fluid and the correct hydraulic fluid level.



CAUTION: Before leaving the tractor seat, lower attachment or loader boom to ground, stop engine, lock brakes, relieve hydraulic pressure, and remove key.

IMPORTANT: Always keep the cylinders in a retracted position when the loader is not in use to guard against rust and contamination which may cause damage to the cylinder rods and hydraulic system.

4.10. REMOVING AIR FROM HYDRAULIC SYSTEM

Repeat raising and lowering the loader boom and bucket until all the air is removed from the system and the system responds properly.

Check the tractor hydraulic fluid level and fill, if required.

4.11. RELIEF NOISE

When operating loaders at high RPMs with orifice installed in attachment circuit, some hydraulic oil will go over pressure relief. This could cause some relief noise from relief cartridge, which is normal.

5. DAILY MAINTENANCE & LUBRICATION

5.1. DAILY CHECKS

5.1.1. Check all hardware daily before operation. Tighten hardware to torque values as specified in the Torque Chart, page 78 unless otherwise specified.

IMPORTANT NOTE: To prevent mounting kit hardware from loosening during operation always torque mounting kit hardware to specified torque noted in Loader Operator Manual. Check bolt torque every 50 hours of loader operation.

5.1.2. With the engine off and the bucket on the ground, inspect all hoses for cuts or wear. Check for signs of leaks and make sure all fittings are tight.



CAUTION: Escaping hydraulic fluid under pressure can have sufficient force to penetrate skin, causing serious personal injury. Before disconnecting lines, be sure to relieve all pressure. Before applying pressure to system, be sure all connections are tight and that lines, tubes, and hoses are not damaged. Fluid escaping from a very small hole can be almost invisible. Use a piece of cardboard or wood, rather than hands, to search for suspected leaks. If injured by escaping fluid, see a doctor at once. Serious infection or reaction can develop if proper medical treatment is not administered immediately.

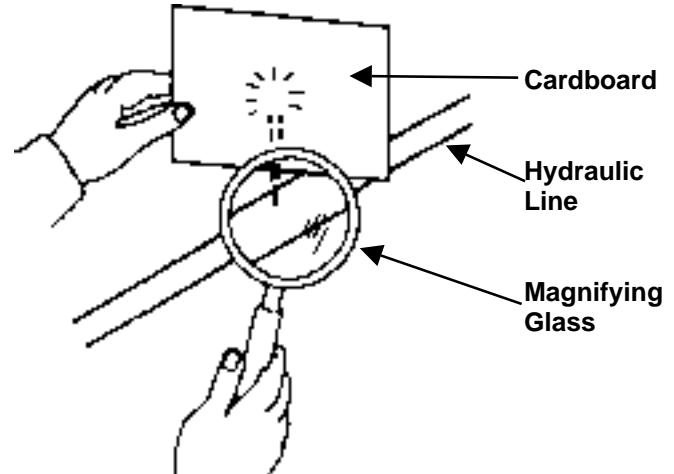

5.1.3. Service your loader at the intervals and locations as specified. When you service your loader, use only high quality lubricants. The engine hour meter on the tractor shows the amount of hours the engine has worked. Use the hour meter to service your loader at the correct time periods.

IMPORTANT: Lower the loader boom to the ground and relieve pressure in loader hydraulic lines prior to doing any service or maintenance operations on the tractor or loader.

Check the tractor hydraulic fluid level as specified in the tractor Operator Manual.

NOTE: When checking hydraulic system fluid level, the loader boom must be on the ground with the bucket or attachment resting flat on a level surface.

5.2. LOADER LUBRICATION

5.2.1. There are 16 grease fittings on this loader, one at each pivot. Lubricate pivots as specified.



CAUTION: Do not stand, walk, or work under a raised loader or attachment unless it is securely blocked or held in position. Accidental movement of the valve handle/handles or leaks in the hydraulic system could cause the loader to drop, or attachment to dump, causing severe injury.

5.2.2. Lower loader boom until bucket or attachment rests on ground, and relieve all hydraulic pressure before lubricating.

(1) Lubricate these 16 pivot points every 10 hours of operation.

NOTE: Lift Cylinder Rod End Grease Zerk must face downward.



5.2.3. During initial setup, and as required; apply a small amount of grease to each tower in areas of tower bottom receiver (A), tower top receiver (B), and handle pin bushing (C). This will aid in parking loader.

Tower

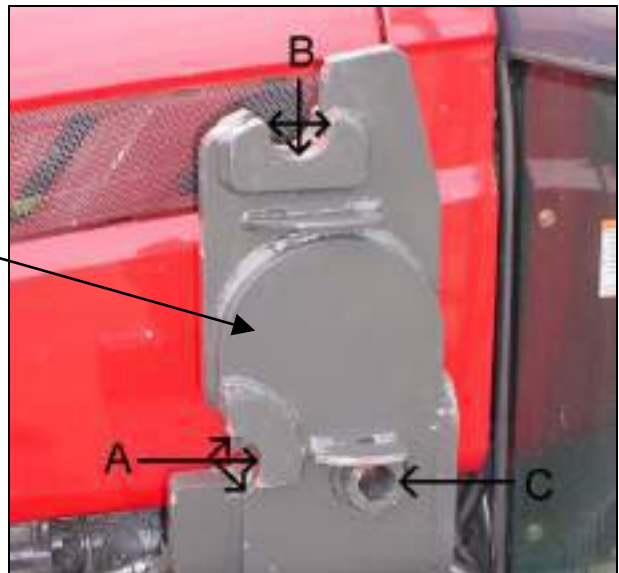

5.2.4. Before servicing your tractor, always do one of the following.

. Park the loader off of the tractor.

B. Position loader with bucket and/or attachment level with ground, then relieve all hydraulic pressure.



CAUTION: Do not stand, walk, or work under a raised loader or attachment unless it is securely blocked or held in position. Accidental movement of valve handle/handles or leaks in the hydraulic system could cause the loader to drop, or attachment to dump, causing severe injury.

5.2.5. Clean area identified with arrow of all material if build up occurs during operation. This will prevent damage to loader components.



NOTE: Clean this area of all material if build up occurs during operation.

5.3. SERVICE AREAS

5.3.1. **RH SIDE SERVICE NOTE:** If a lift cylinder hose is replaced, always locate and secure hose as shown in photo to prevent hose from being pinched between loader and cylinder causing damage to hose.

RH Lift Cylinder Base End Hose

RH Lift Cylinder Rod End Hose

Nylon Ties

NOTE: Route hoses so they either do not contact notch area or they only rest against notch area. Do not twist hoses so they are pulled against notch area.



5.3.2. **LH SIDE SERVICE NOTE:** If a lift cylinder hose is replaced, always locate and secure hose as shown in photo to prevent hose from being pinched between loader and cylinder causing damage to hose.

LH Lift Cylinder Rod End Hose

LH Lift Cylinder Base End Hose

Nylon Ties



6. OPERATING INSTRUCTIONS

The loader should be operated with the tractor engine running from 1700 to 2200 rpm. Excessive speeds are dangerous, and may cause bucket spillage and unnecessary strain on the tractor and loader. When operating in temperatures below 30°F, run the tractor engine below 1200 rpm until the hydraulic fluid temperature exceeds 30°F. The following text and illustrations offer suggested loader and tractor operating techniques.

6.1. FILLING THE BUCKET

Approach and enter the pile with a level bucket. Then rollback and lift the bucket.

The rollback and lifting of the bucket will increase efficiency because a level bucket throughout the lifting cycle resists bucket lift and increases breakaway effort.

NOTE: Do not be concerned if the bucket is not completely filled during each pass. Maximum productivity is determined by the amount of material loaded in a given period of time. Time is lost if two or more attempts are made to fill the bucket on each pass.

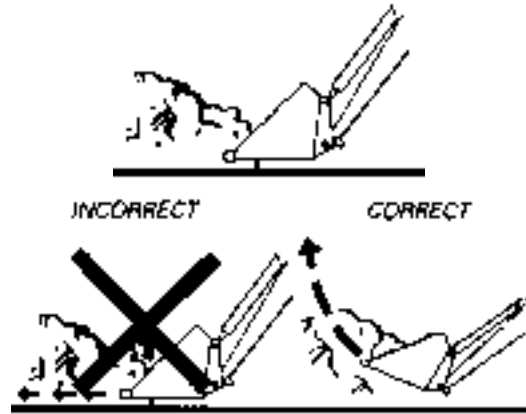

6.2. LIFTING THE LOAD

When lifting the load, keep the bucket positioned to avoid spillage.



CAUTION: Do not attempt to lift bucket or attachment loads in excess of the loader capacity.

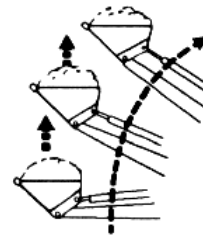

6.3. CARRYING THE LOAD

Position the loader in a low position when transporting a loaded or empty bucket or attachment. Use extreme care when operating the loader on a slope. Keep the bucket as low as possible. This keeps the bucket and tractor center of gravity low and will provide maximum tractor stability.



CAUTION: Operating the loader on a hillside is dangerous and is not recommended.

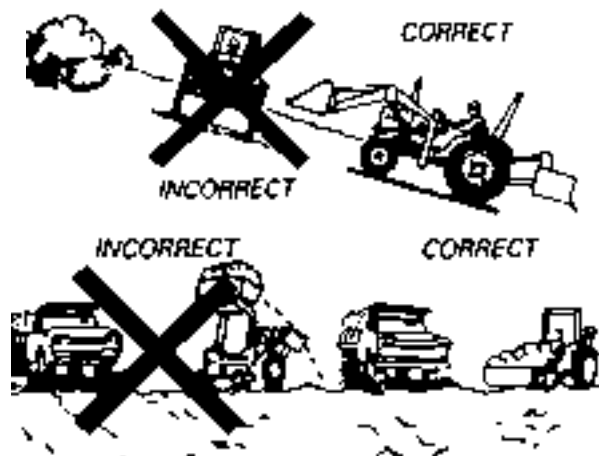

When transporting a load, keep the bucket as low as possible to avoid tipping, in case a wheel drops in a rut.

6.4. DUMPING THE BUCKET

Lift the bucket just high enough to clear the side of the vehicle. Move the tractor in as close to the side of the vehicle as possible, then dump the bucket.



6.5. LOWERING THE BUCKET

After the bucket is dumped, back away from the vehicle while lowering and rolling back the bucket.

6.6. OPERATING WITH FLOAT CONTROL

During operation on hard surface, keep the bucket level and position the lift control in the float position to permit the bucket to float on the work surface. If hydraulic down pressure is exerted on the bucket, the cutting edge will wear faster than normal.

The float position will also avoid mixing of surface material with stockpile material. The float position will reduce the chance of surface gouging while removing snow or other material, or when working with a blade.

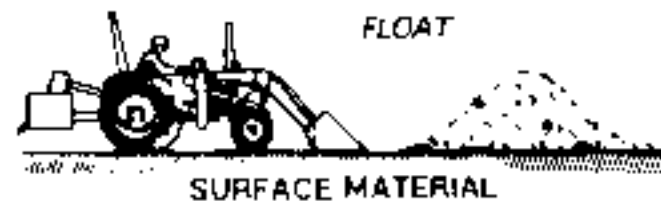

6.7. LOADING FROM A BANK

Choose a forward gear that provides a safe ground speed and power for loading.



CAUTION: Exercise caution when undercutting high banks. Dirt slides can be dangerous. Load from as low as possible for maximum efficiency. Loader lift and breakaway capacity diminish as loading height is increased.



Side cutting is a good technique for cutting down a big pile.



If the pile sides are too high and liable to cause cave-in, use the loader to break down the sides until a slot can be cut over the top.



Another method for large dirt piles is to build a ramp approach to the pile.



It is important to keep the bucket level when approaching a bank or pile. This will help avoid gouging the work area.

6.8. PEELING AND SCRAPING

Use a slight bucket down angle, travel forward, and hold the lift control forward to start the cut. Make a short cut and breakout cleanly.

With the bucket level, start a cut at the notch approximately 2 in. deep. Hold the depth by feathering the tilt control to adjust the cutting edge up or down. When the front tires enter the notch, adjust the lift cylinder to maintain proper depth.

Make additional passes until the desired depth is reached. During each pass, use only the tilt control while at working depth. This will allow you to concentrate on controlling the bucket angle to maintain a precise cut.

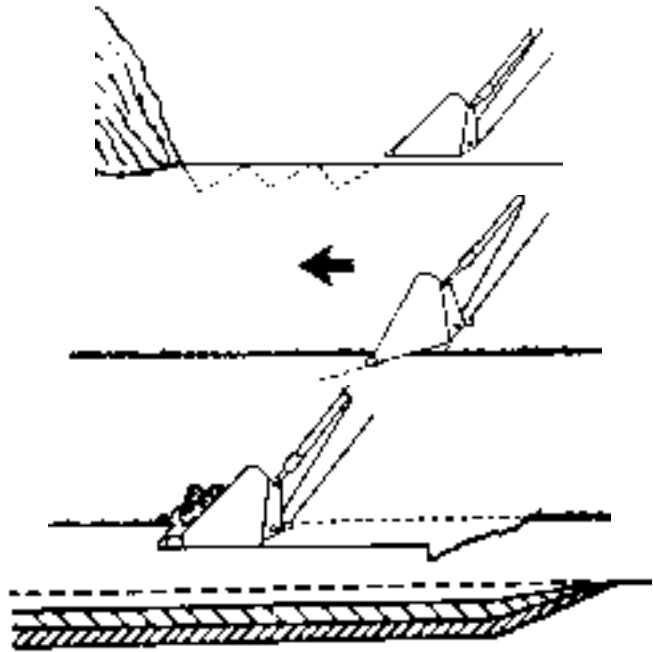

6.9. LOADING LOW TRUCKS OR SPREADERS FROM A PILE

For faster loading, minimize the angle of turn and length of run between pile and spreader.

Back grade occasionally with a loaded bucket to keep the work surface free of ruts and holes. Also, hold the lift control forward so the full weight of the bucket is scraping the ground. Use the heel of the bucket.

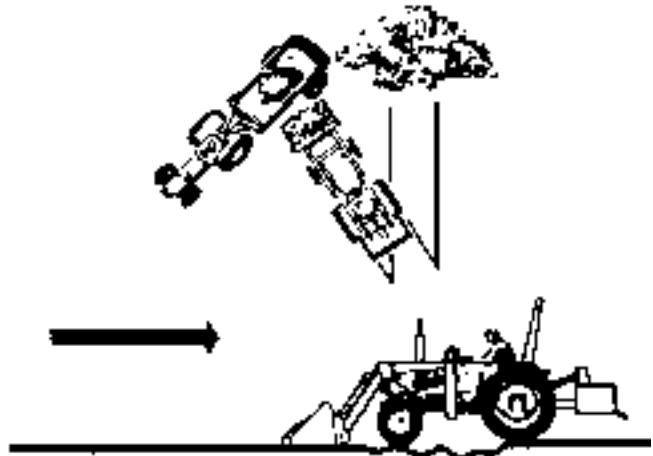

6.10. BACKFILLING

Approach the pile with the bucket flat.

Poor operating methods actually move no more dirt and make it more difficult to hold a level grade. Do not use the bucket in the dumped position for bulldozing. This method will impose severe shock loading on the dump-linkage, the tilt cylinders, and the tractor.

Leave dirt in the bucket because dumping on each pass wastes time.

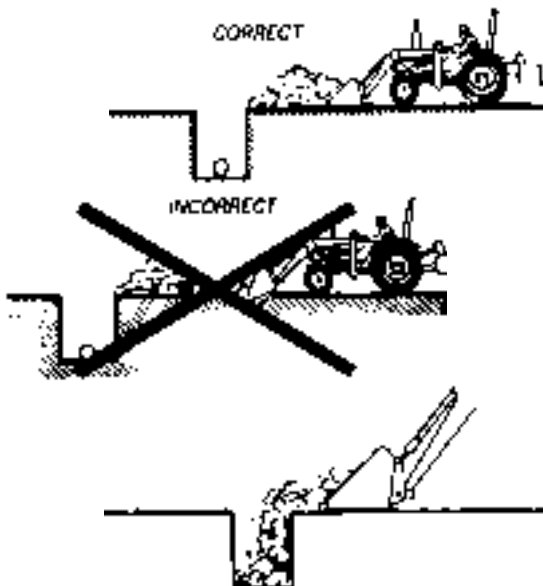

Operate at right angles to the ditch, taking as big a bite as the tractor can handle.

Leave dirt that drifts over the side of the bucket for final clean up.

Pile dirt on the high side for easier backfilling on a slope.

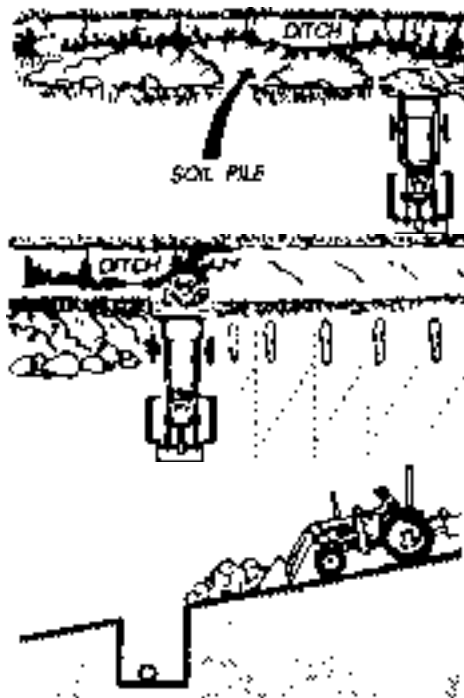

6.11. HANDLING LARGE HEAVY OBJECTS

CAUTION: Handling large heavy objects can be extremely dangerous due to:



- Danger of rolling the tractor over.
- Danger of upending the tractor.
- Danger of object rolling or sliding down the loader boom onto the operator.

CAUTION: If you must perform the above work, protect yourself by:



- Never lifting the load higher than necessary to clear the ground when moving.
- Adding rear ballast to the tractor to compensate for the load.
- Never lifting large objects with equipment that does not have an anti-rollback device.
- Moving slowly and carefully; avoiding rough terrain.

6.12. BACK GRADING

When back grading, the angle between the bottom of the bucket and the ground must not be more than 15 degrees. Failure to follow these instructions could cause loader tilt cylinders to fail and void warranty.



7. DISMOUNTING THE LOADER



CAUTION: Always park loader with material bucket attached to the loader.



CAUTION: Before leaving the tractor seat, lower attachment or loader boom to ground, stop engine, lock brakes, relieve hydraulic pressure, and remove key.



CAUTION: Do not stand, walk, or work under a raised loader or attachment unless it is securely blocked or held in position. Accidental movement of valve handle/handles or leaks in the hydraulic system could cause the loader to drop, or attachment to dump, causing severe injury.



CAUTION: Do not allow bystanders in loader work area.

IMPORTANT: Never allow weight of tractor to be placed on parking stands when mounting or dismounting loader.

7.1.1. Position the loader on a hard level surface. The more level the surface the easier the loader is to mount and dismount.

7.1.2. Raise loader, dump bucket over, and then lower loader so that bucket cutting edge is approximately 1/2" off of ground.



7.1.3. Remove rubber strap and loosen hoses from RH side of tractor cab.



7.1.4. Remove snap pins from handle pins located in bearing boxes.

Bearing Box

Handle Pin

Snap Pin

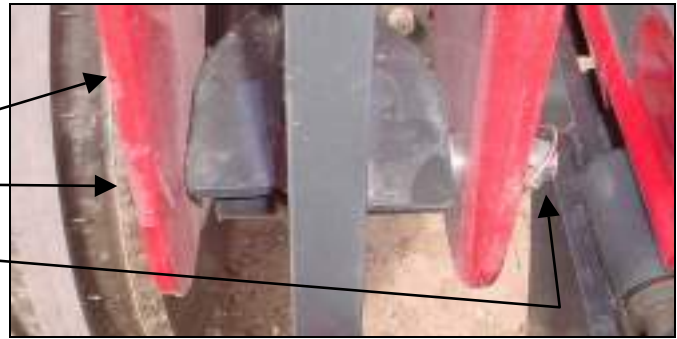

7.1.5. Remove handle pins from bearing boxes.

Bearing Box

Handle Pin



7.1.6. Remove parking stands from storage positions in the boom crosstubes. Return hairpin cotters to storage positions.

**Hairpin Cotter
in Storage Position.**

**Parking Stand
in Storage Position.**

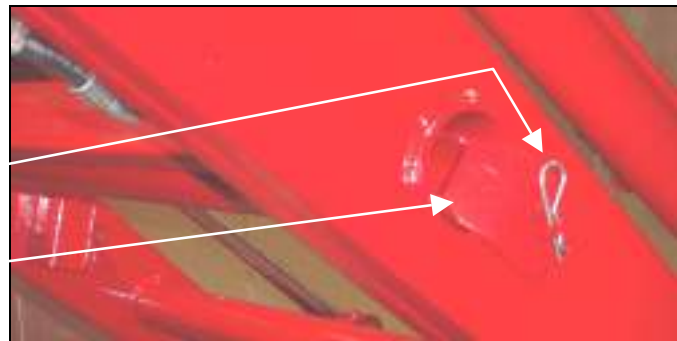

7.1.7. Position parking stands in attaching brackets on inside of each boom arm. Secure using clevis pins and hairpin cotters.

**Clevis Pin and Hairpin Cotter
in Park Position.**

Attaching Bracket.

**Parking Stand
in Park Position.**

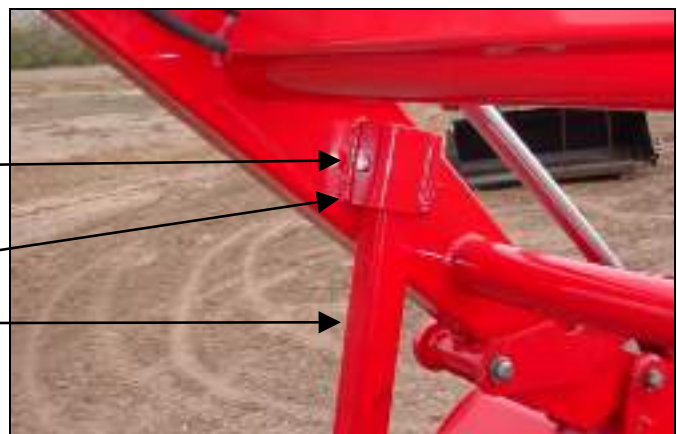

7.1.8. Make sure long end of parking stand is located toward rear end of tractor. Photo shows parking stands in park position and loader ready to be dismounted.

Parking Stands in Park Position with long end of stands positioned rearward.



7.1.9. Retract tilt cylinders (A) to roll bucket back and retract lift cylinders (B) to lower loader boom down until parking stands make firm contact with ground.

NOTE: Driving the tractor forward slowly while positioning loader will allow parking stands to contact ground firmly.

**Parking Stands contacting ground firmly.
Bucket resting on ground.**



7.1.10. Retract lift cylinders (C) until bearing box pins (D) lift out of tower hooks and clear towers.



7.1.11. Slowly drive tractor forward while (E) retracting tilt cylinders (F). Doing this will allow towers to guide loader as it is being parked off of tractor. This will allow loader to be held in position to clear exhaust during dismounting.



7.1.12. Retract tilt cylinders (G) until bucket is level on ground.

7.1.13. Make sure all loader components clear tractor. Back tractor away (H) slightly.

7.1.14. Stop the tractor engine and then work valve handle/handles to relieve hydraulic fluid pressure in lines. Refer to tractor operator manual for additional information.



7.1.15. Reinstall handle pins and snap pins to bearing boxes for storage.

7.1.16. Return rubber strap to RH Cab hand rail for storage.

7.1.17. Disconnect loader hoses from quick couplers.

7.1.18. Start tractor and slowly back tractor away from the loader.



IMPORTANT: To avoid hydraulic hose damage, be alert and make sure hoses do not catch on tractor and/or loader during mounting or dismounting.

WARNING: Make sure parked loader is on a hard level surface. Engage all safety devices to prevent loader from falling and being damaged or injuring someone. Do not repair loader if it is not mounted on the tractor. Loss of hydraulic fluid or removal of parts could cause loader to collapse resulting in injury.



8. MOUNTING THE LOADER



CAUTION: Do not stand, walk, or work under a raised loader or attachment unless it is securely blocked or held in position. Accidental movement of valve handle/handles or leaks in the hydraulic system could cause the loader to drop, or attachment to dump, causing severe injury.



CAUTION: Do not allow bystanders in loader work area.

IMPORTANT: Never allow weight of tractor to be placed on parking stands when mounting or dismounting loader.

8.1.1. To aid in mounting and dismounting loader, apply a small amount of grease, if needed, to each tower in areas of tower bottom receiver (A), tower top receiver (B), and handle pin bushing (C).

Tower

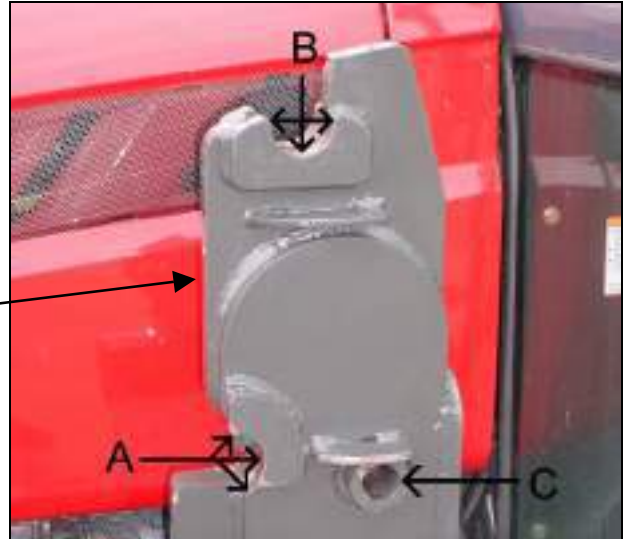

8.1.2. Remove handle pins and snap pins from bearing boxes.

8.1.3. Slowly drive tractor forward to a position where the hoses can be connected to the quick couplers.

8.1.4. Stop the engine. Connect the loader hydraulic hoses to the correct quick couplers.

8.1.5. Route loader hoses away from exhaust between exhaust and cab.



8.1.6. Check that lift cylinders are fully retracted. Then drive tractor forward. Use tilt cylinders to position height of bearing box top pin making sure all loader components clear all tractor components.

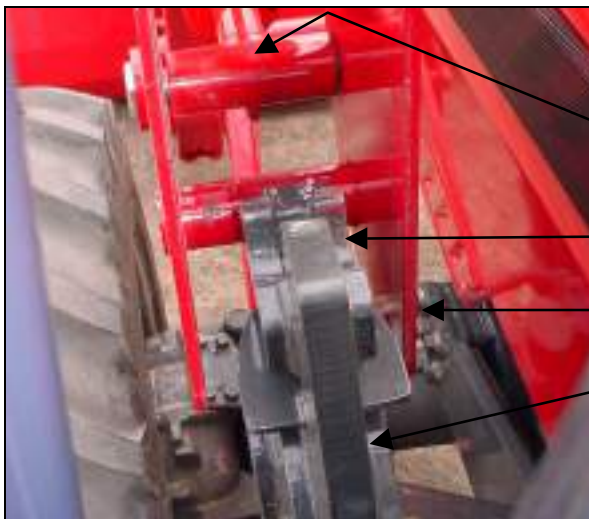

Bearing Box Top Pin

Tower Top Receiver

Bearing Box

Tower

8.1.7. Align bearing box top pin with tower top receiver guide post, both sides. Make sure loader is centered right to left on both towers.

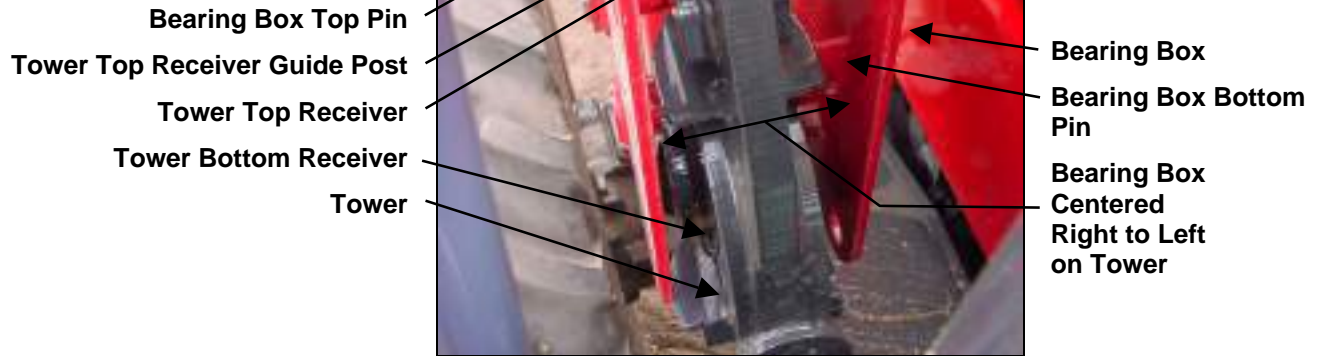

8.1.8. Extend lift cylinders (A) slowly making sure loader seats completely in tower top receivers (B) and tower bottom receivers (C).

8.1.9. Extend tilt cylinders (D) until bucket is rolled over 90°. Adjust lift cylinder so bucket is approximately 1/2" off ground.

8.1.10. Secure loader to mounting brackets as follows.

Bucket positioned 1/2" off ground.



8.1.11. Reinstall handle pins to bearing boxes and secure using snap pins.

Bearing Box

Handle Pin and Snap Pin



8.1.12. Remove parking stands from parked position. Return clevis pins and hairpin cotters to attaching brackets for storage.

Clevis Pin and Hairpin Cotter in Park Position.

Attaching Bracket.

Parking Stand in Park Position.

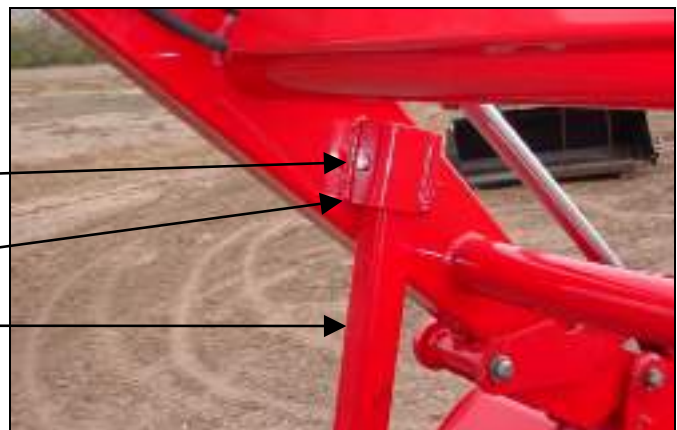

8.1.13. Return parking stands to storage positions in the boom crosstubes. Secure using hairpin cotters.

**Hairpin Cotter
in Storage Position.**

**Parking Stand
in Storage Position.**

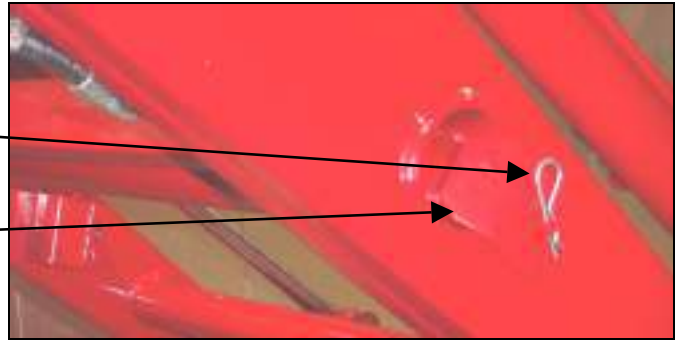

8.1.14. Remove rubber strap from RH cab hand rail.

8.1.15. Route hoses away from tractor exhaust.

**Loader Hoses
(route toward center of tractor)**

Tractor Exhaust



8.1.16. Route hoses to RH side of tractor cab as shown. Secure hoses to cab hand rail using rubber strap.

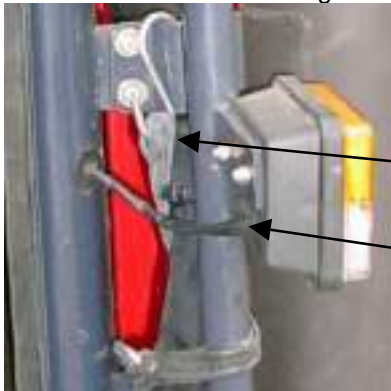

Tractor Exhaust

Loader Hoses

RH Tractor Cab Hand Rail

**Rubber Strap secured
to Cab Hand Rail**

**Rubber Strap wrapped
around Tractor Hoses**



IMPORTANT: To avoid hydraulic hose damage, be alert and make sure hoses do not catch on tractor and/or loader during mounting or dismounting.

9. OPTIONAL GRILL GUARD

9.1. INSTALLATION INSTRUCTIONS

9.1.1. Attach grill guard to front of tractor.
Secure re-using tractor hardware.

Grill Guard.
Tractor Hardware,
6 places.



9.1.2. Weight Frame of tractor can be attached to
front face of Grill Guard. Secure re-using tractor
hardware.

Grill Guard
Weight Frame



10. PIN ON BUCKET

IMPORTANT: Read safety information in this section and on decals before operating attachments.

WARNING: To avoid serious injury or death from large round or square hay bale handling:



- Use only Factory bale spear or bale retaining device handler attachment when handling round bales.
- Do not handle large square bales without a retaining device handler attachment
- Do not use buckets, forks, or other attachments without bale retaining devices.
- Do not use loader for handling large, heavy objects such as logs, tanks, etc.

WARNING: To avoid serious injury or death, realize handling large heavy objects can be extremely dangerous due to:



- Danger of rolling the tractor over.
- Danger of upending the tractor.
- Danger of the object rolling or sliding down the loader arms onto the operator.

WARNING: To avoid serious injury or death:



- Do not lift or carry anyone on buckets, forks, probes, or any other portion of the loader or loader attachments.
- Avoid contact with electrical power lines by loader or attachment



WARNING: Inadvertent movement of the loader or attachment could result in serious injury or death.

10.1. INSTALLATION INSTRUCTIONS TO PIN ON QUICK ATTACH

IMPORTANT: Refer to Pages 55 to 57 for instructions concerning Installing Attachment to Pin On Quick Attach.

IMPORTANT: Refer to Page 58 for instructions concerning Removing Attachment from Pin On Quick Attach.

10.2. INSTALLATION INSTRUCTIONS DIRECT TO LOADER

10.2.1. Install pin on bucket direct to loader. Secure using pins and e-clips.

NOTE: Clean arrow area of all material if build up occurs during operation.

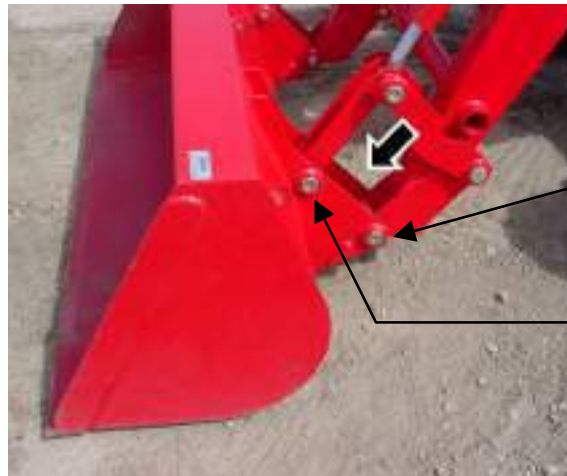



Bottom Pin
1-1/8" x 7.01"
and E-Clip,
1 place each side.

Top Pin
1-1/8" x 7.01"
and E-Clip,
1 place each side.

11. PIN ON BALE SPEAR

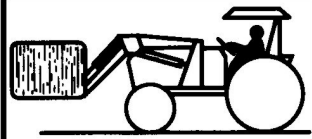

CAUTION

To avoid serious injury or death:

- Read operators manual and decals before operating. Follow all safety, operating, and service instructions. Contact dealer for replacement.
- Be careful during loading, transporting, and stacking to minimize rolling bales and tractor tip over.
- ROPS (Roll-Over Protective Structures) and seat belt equipped tractors are recommended for operator use in all bale probe operations.
- Do not allow riders on tractor, loader, or bale probe.
- Avoid loading/unloading bales on sloping or uneven surfaces.
- Avoid transporting with bales raised high. Keep bales tilted back and low to the surface while moving.
- Approach, penetrate, and transport bales at low speeds. Reduce speeds on curves, hills, rough ground, or when turning.
- Do not lift anything with bale probe except round bales.
- Never raise round bale to full height with bale probe rolled back.
- Park and store bale probe points pointed against bale, building, or other stable object.

0595-3054

IMPORTANT: Read safety information in this section and on decals before operating attachments.



DANGER



To avoid serious injury or death:

- Unload only on a level surface.
- Keep bystanders clear of work area when loading and unloading bales.

0595-3050



CAUTION

To prevent bodily injury and loader instability when detaching loader, equip loader with a material bucket or a manure fork.

0595-2190



IMPORTANT: It is not recommended that loader be detached with bale spear attached. Loaders will park safely; however, bale spear could be damaged during parking. Always detach loader with bucket or other loader Factory approved attachment attached.



CAUTION: When transporting a round bale, tilt the bale spear slightly back from level and carry the load in a low position.



CAUTION: Never raise round bale to full height with bale spear rolled back as serious injury or death could occur.



CAUTION: To prevent bodily injury, park and store bale spear with points pointed against bale, building, or other stable object.

11.1. PIN ON BALE PROBE

IMPORTANT: This spear is a high strength alloy – drop forged steel and should not be welded or heat-treated.

IMPORTANT: Maximum load limit on super penetrator bale spear is 2,000 pounds.

11.2. ASSEMBLY INSTRUCTIONS

11.2.1. Install Bale Spear into tapered sleeve and secure with nut. Torque nut 515 ft. lb. Failure to follow these instructions could cause damage to spear and void your warranty.

(1) Upper Spear.

Flat surface of spear located upward.

(2) Tapered Sleeve.

(3) Upper Spear Nut, 28mm.

Torque nut to 515 ft. lb.

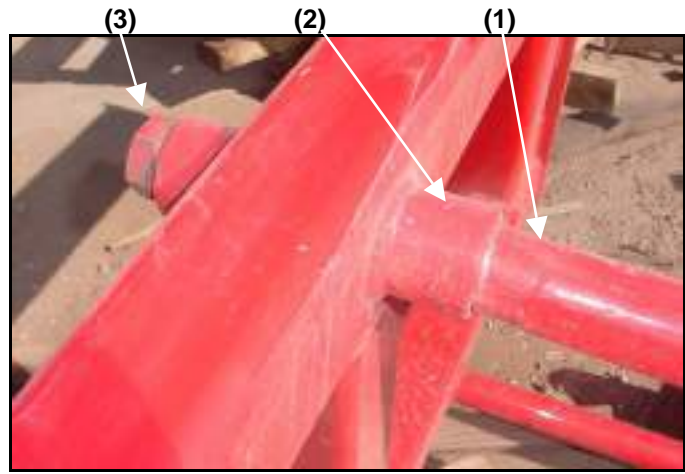

11.3. INSTALLATION INSTRUCTIONS TO PIN ON QUICK ATTACH

IMPORTANT: Refer to Pages 55 to 57 for instructions concerning Installing Attachment to Pin On Quick Attach.

IMPORTANT: Refer to Page 58 for instructions concerning Removing Attachment from Pin On Quick Attach.

11.4. INSTALLATION INSTRUCTIONS DIRECT TO LOADER

11.4.1. Install pin on bale spear direct to loader. Secure using pins and e-clips.

Top Pin 1-1/8" x 7.01" and E-Clip, 1 place each side.

Bottom Pin 1-1/8" x 7.01" and E-Clip, 1 place each side.

11.5. OPERATING INSTRUCTIONS

11.5.1. With bale spear level with ground, slowly spear bale slightly above center.



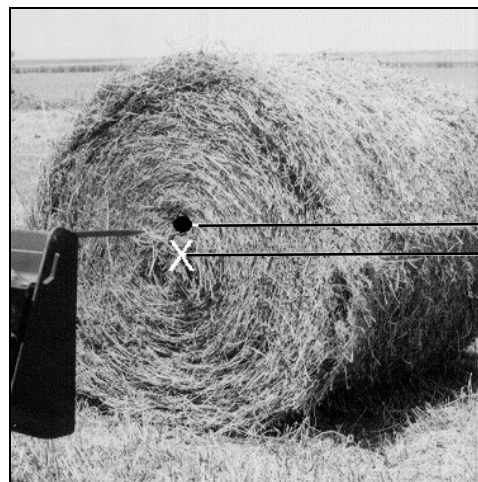

11.5.2. With all three spears completely engaged into bale, tilt bale spear slightly back from level and transport the load in a low position.



Spear bale slightly above center of bale.

12. PIN ON PALLET FORK

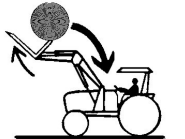
IMPORTANT: Read safety information in this section and on decals before operating attachments.

	 <h3>WARNING</h3>	<ul style="list-style-type: none"> • Always keep pallet forks level when raising loads. • Avoid raising loads to full heights with pallet forks rolled back. • ROPS (Roll-Over Protective Structures) and seat belt equipped tractors are recommended for operator use in all pallet fork operations. • Do not lift or carry anyone on buckets, forks, probes, or any other portion of the loader or loader attachments. • Do not allow riders on tractor, loader, or forks. • Avoid contact with electrical power lines by loader or attachments.
	<p>To avoid serious injury or death:</p>	<p>0595-3052</p>
	<ul style="list-style-type: none"> • Do not use pallet fork attachment to lift large objects, round bales, or items that may roll or slide down loader arms onto the operator. • Never operate pallet fork without attaching plate guard. • Keep loads below pallet forks attaching plate guard heights. • Always transport loads with pallet forks low and level to ground. 	

 <h3>CAUTION</h3>
<p>Maximum load limit on combined pair of forks is 5700 pounds.</p> <p>0595-3053</p>

 <h3>CAUTION</h3>
<p>To prevent bodily injury and loader instability when detaching loader, equip loader with a material bucket or a manure fork.</p> <p>0595-2190</p>



WARNING: The pallet fork attachment is specifically designed to engage and load palletized materials. Do not use forks to handle large loads such as bales, posts, etc. as they can fall or roll back onto operator causing serious injury or death.



CAUTION: Maximum load limit on combined pair of forks is 5700 pounds.

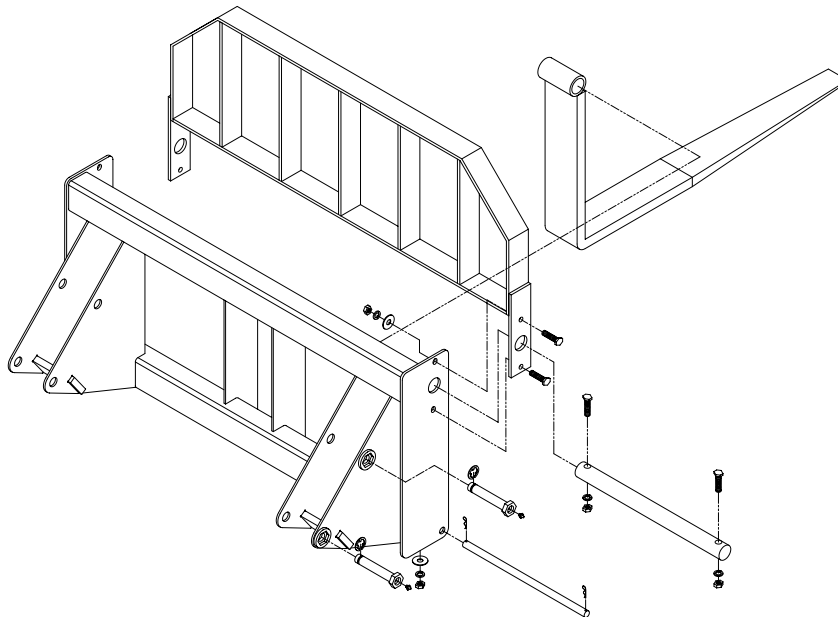

12.1. PIN ON PALLET FORK

12.1.1. The Pin On Pallet Fork has two tines each 1-1/2" x 4" x 42".

12.2. ASSEMBLY INSTRUCTIONS

12.2.1. Install (4) guard to (7) pallet fork frame using (5) 1-2" x 1-1/2" bolt, lockwasher, flatwasher, and nut, 2 places each side.

12.2.2. Install (3) forks to (7) pallet fork frame using (1) pins, 2 places secure using (2) 3/8" x 2-1/2" bolts, lockwashers, and nuts, 4 places.

12.2.3. Locate (6) hooks on (3) forks on backside of angle to prevent fork rotation.

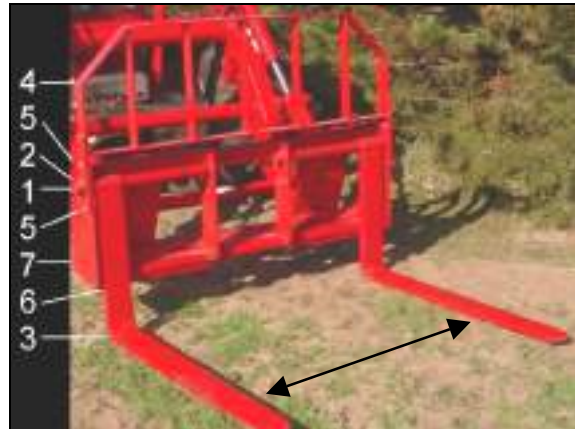

12.3. INSTALLATION INSTRUCTIONS PIN ON QUICK ATTACH

IMPORTANT: Refer to Pages 55 to 57 for instructions concerning Installing Attachment to Pin On Quick Attach.

IMPORTANT: Refer to Page 58 for instructions concerning Removing Attachment from Pin On Quick Attach.

12.4. INSTALLATION INSTRUCTIONS DIRECT TO LOADER

12.4.1. Install pin on bale spear direct to loader. Secure using pins and e-clips.

Top Pin 1-1/8" x 7.01" and E-Clip, 1 place each side.

Bottom Pin 1-1/8" x 7.01" and E-Clip, 1 place each side.

12.5. OPERATING INSTRUCTIONS

The operator must keep the load centered and as far back on the forks as possible. Operator must always keep load level. Carry the load low and at a slow speed.

12.6. PARKING INSTRUCTIONS

If parking loader from tractor with pallet fork attachment, move forks outward to widest position (see photo above).

NOTE: Move Forks outward to Widest Position

12.7. PARKING STABILITY

If parking pallet fork off of loader, store as shown at right for stability.



13. OPTIONAL PIN ON QUICK ATTACH SYSTEM

IMPORTANT: Read safety information in this section and on decal before operating attachment.

 **WARNING**

Do not operate without confirmation that coupler pins are fully engaged. Loader attachment can fall off if not properly attached. To avoid serious injury or death:

- Only use loader manufacturer approved attachments.
- Read all operators manuals and decals before operating. Follow all safety, operating, and service instructions. Contact dealer for replacement parts.

0595-3051

NOTE: Pin On Quick Attach System is optional equipment



WARNING: Always read and follow operating instructions before operating Pin On Quick Attach System.

13.1. RECOMMENDED LOADER FACTORY APPROVED ATTACHMENTS

IMPORTANT: Use only Loader Factory Approved Attachments for mounting on this Pin On Quick Attach System.

13.2. PIN ON QUICK ATTACH



WARNING: Always read and follow operating instructions before operating Pin On Quick Attach System.

13.2.1. Install pin on quick attach direct to loader. Secure using pins and e-clips.

Top Pin
1-1/8" x 7.01"
and E-Clip,
1 place each side.

Bottom Pin
1-1/8" x 7.01"
and E-Clip,
1 place each side.



14. INSTALLING BUCKET OR ATTACHMENT TO PIN ON QUICK ATTACH



CAUTION: Before leaving the tractor seat, stop the engine and lock brakes when installing or removing bucket or attachment.



CAUTION: Do not stand, walk, or work under a raised loader or attachment unless it is securely blocked or held in position. Accidental movement of valve handle/handles or leaks in the hydraulic system could cause the loader to drop, or attachment to dump, causing severe injury.

14.1. RECOMMENDED LOADER FACTORY APPROVED ATTACHMENTS

14.1.1. Use only the following Loader Factory Approved Attachments for mounting on this Pin On Quick Attach System.

- ◆ Pin On Bucket 72"
- ◆ Pin On Bucket 78"
- ◆ Pin On Bucket 84"
- ◆ Pin On Bale Spear
- ◆ Pin On Pallet Fork

14.2. OPERATING INSTRUCTIONS

14.2.1. Make sure the following areas of Pin On Quick Attach are clean (SEE WHITE ARROWS).

14.2.2. Install pin on quick attach direct to loader. Secure using pins and e-clips.

Top Pin 1-1/8" x 7.01" and E-Clip, 1 place each side.

Bottom Pin 1-1/8" x 7.01" and E-Clip, 1 place each side.

14.2.3. To attach bucket or attachment to loader, lower loader boom to ground with pin on quick attach rolled forward slightly. Pull up on pin handle until spring pin is above top bushing surface. Rotate pin assembly slightly. Flip handle forward. Repeat for other side.

Pin Assembly – pull up and rotate.

Spring Pin – resting on top edge of bushing.

Handle – flipped forward.

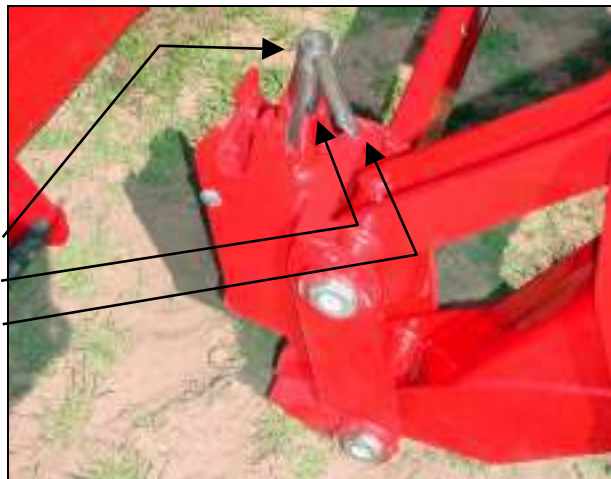
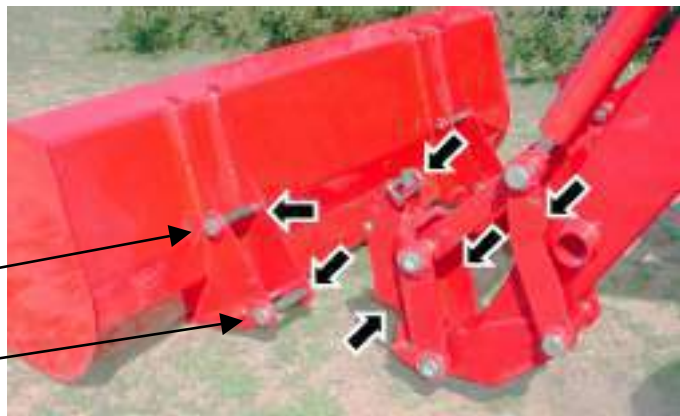

14.2.4. Roll quick attach forward by extending tilt cylinders just enough to allow pin on quick attach receiver to engage bucket or attachment upper pin. Drive tractor forward, aligning quick attach with bucket or attachment.

Bucket or Attachment Upper Pin

Quick Attach Receiver – align with bucket or attachment upper pin.

Quick Attach - roll forward and lower.

NOTE: Over extension of tilt cylinders during this operation could cause damage to Pin On Quick Attach handles due to handles contacting bucket or attachment. Make sure handles are flipped forward.

14.2.5. When pin on quick attach is aligned with pin on bucket or attachment, raise loader boom slowly making sure pin on quick attach receivers engage attachment. Then roll quick attach back slowly.

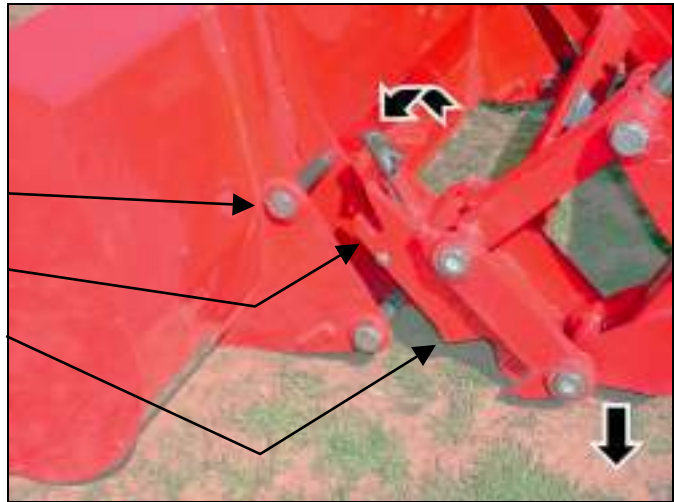

14.2.6. Position loader so attachment is approximately 1" off ground. Position pin assembly into the engaged position by pulling up on handle and rotating pin assembly so the spring pin is located in bushing slot. Repeat for other side.

Pin Assembly – rotate pin assembly so that spring pin is fully engaged in bushing slot.

Attachment – approximately 1" off of ground.

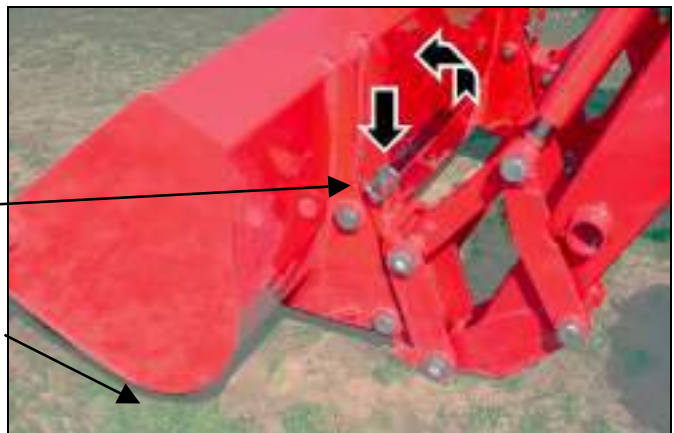

14.2.7. Check that bucket or attachment is securely attached to pin on quick attach by raising loader boom 3 to 4 feet, dumping bucket or attachment against stops, and checking to be sure bottom of bucket or attachment does not roll forward away from pin on quick attach.



WARNING: A bucket or attachment that is not securely locked into Pin On Quick Attach could come off during loader operation causing serious injury or death.

14.2.8. Inspect Pin On Quick Attach attaching areas to verify that Pin On Quick Attach pins have engaged bucket or attachment fully.

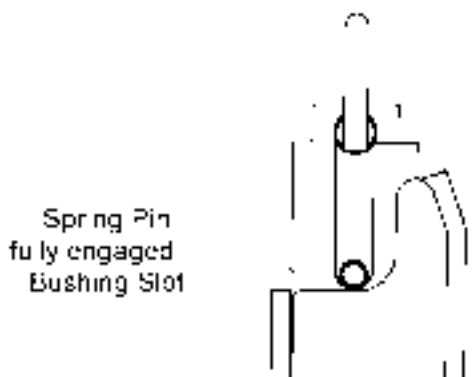

Spring Pin – fully engaged in bushing slot.

Bucket or Attachment Lower Pin.

Pin On Quick Attach Pin Assembly engaging bucket or attachment.

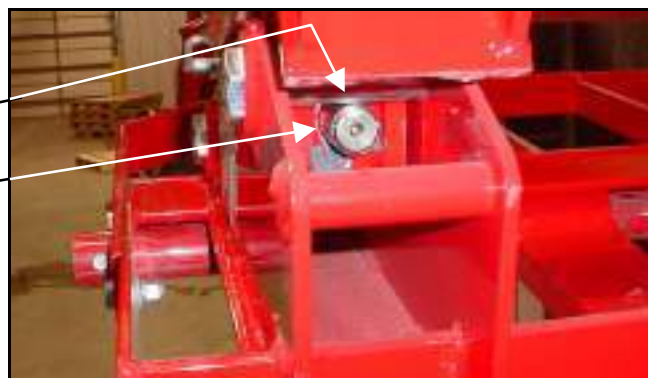

15. REMOVING BUCKET OR ATTACHMENT FROM PIN ON QUICK ATTACH



CAUTION: Before leaving the tractor seat, stop the engine and lock brakes when installing or removing bucket or attachment.



CAUTION: Do not stand, walk, or work under a raised loader or attachment unless it is securely blocked or held in position. Accidental movement of valve handle/handles or leaks in the hydraulic system could cause the loader to drop, or attachment to dump, causing severe injury.

15.1. OPERATING INSTRUCTIONS

15.1.1. To disconnect bucket or attachment from loader, position bucket or attachment slightly rolled back and approximately 1" off of ground. Pull up on pin handle until spring pin is above top bushing surface. Rotate pin assembly slightly. Flip handle forward. Repeat for other side.

Bucket or Attachment – rolled slightly back.

Pin Assembly – pull up and rotate.

Spring Pin – resting on top edge of bushing.

Handle – Flip Forward.

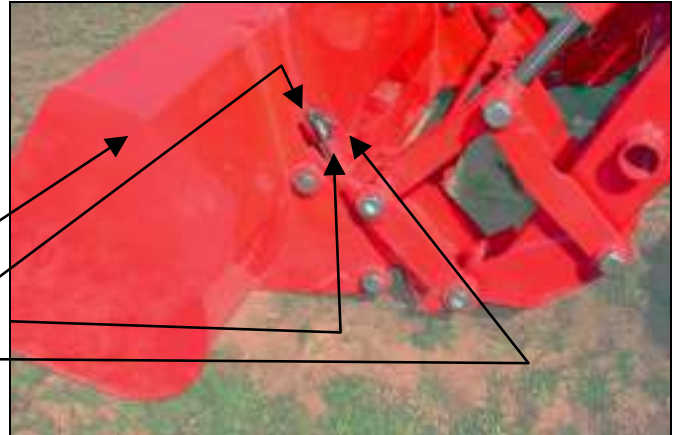

15.1.2. Roll bucket or attachment forward and lower to ground. Back loader away from bucket or attachment.

NOTE: Over extension of tilt cylinders during this operation could cause damage to Pin On Quick Attach handle due to handle contacting bucket or attachment.



15.1.3. Position pin assembly into the engaged position by pulling up on handle and rotating pin assembly so the spring pin is located in bushing slot. Repeat for other side.

Pin Assembly – Rotate pin assembly so that spring pin is fully engaged in bushing slot.



16. SERVICE AND LUBRICATION FOR PIN ON QUICK ATTACH

16.1. KEEP THESE AREAS CLEAN

16.1.1. Keep these areas clean to allow pin on quick attach system to function properly.

IMPORTANT: To maintain your Pin On Quick Attach System functioning properly, always inspect Pin On Quick Attach System components for damage or wear. If damage or wear exists, replace components immediately.



16.2. LUBRICATE ANNUALLY

16.2.1. Lubricate Quick Attach Pins annually using a good grade of grease. Remove front covers of quick attach by loosening 3/8" nut and then removing sealant and cover plate. Grease components and pin and then reinstall cover plate and seal using Sika-Flex Sealant.

Lubricate these areas of Pin On Quick Attach.

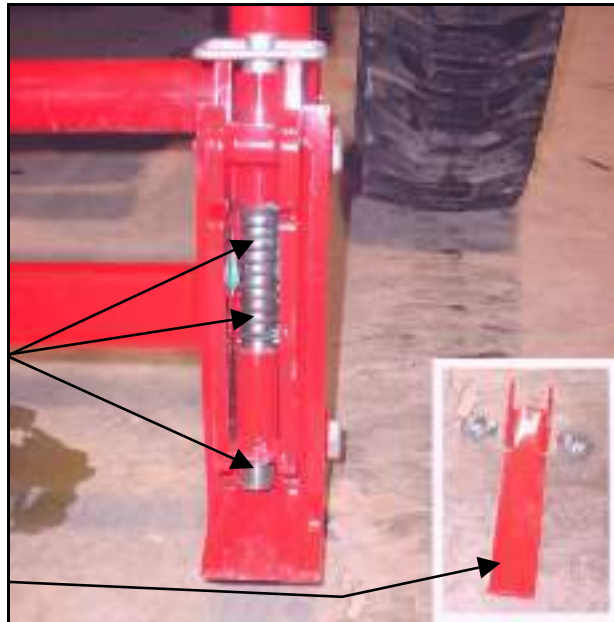

Cover Plate shown removed.

Lubricate these areas of Pin On Quick Attach.



17. OPTIONAL SKID STEER TOOL CARRIER SYSTEM

IMPORTANT: Read safety information in this section and on decal before operating attachment.



WARNING

Do not operate without confirmation that coupler pins are fully engaged. Loader attachment can fall off if not properly attached.

To avoid serious injury or death:

- Only use loader manufacturer approved attachments.
- Read all operators manuals and decals before operating. Follow all safety, operating, and service instructions. Contact dealer for replacement parts.

0595-3051

NOTE: Skid Steer Tool Carrier System is optional equipment



WARNING: Always read and follow operating instructions before operating Skid Steer Tool Carrier System.



17.1. RECOMMENDED LOADER FACTORY APPROVED ATTACHMENTS

17.1.1. Use only Loader Factory Approved Attachments for mounting on this Skid Steer Tool Carrier System.

17.2. NON-LOADER FACTORY ATTACHMENTS

17.2.1. If you are going to connect a non-Loader Factory Attachment to this Skid Steer Tool Carrier System, read and understand the following instructions and safety information. Always make sure Skid Steer Tool Carrier is locked onto all attachments.

NOTE "A": If your attachment back is not running at a 20 degree angle, your loader rollback and dump angles will change per attachment angle change.

NOTE "B": If your attachment point is lower than this, your attachment may not touch the ground when loader is fully lowered.

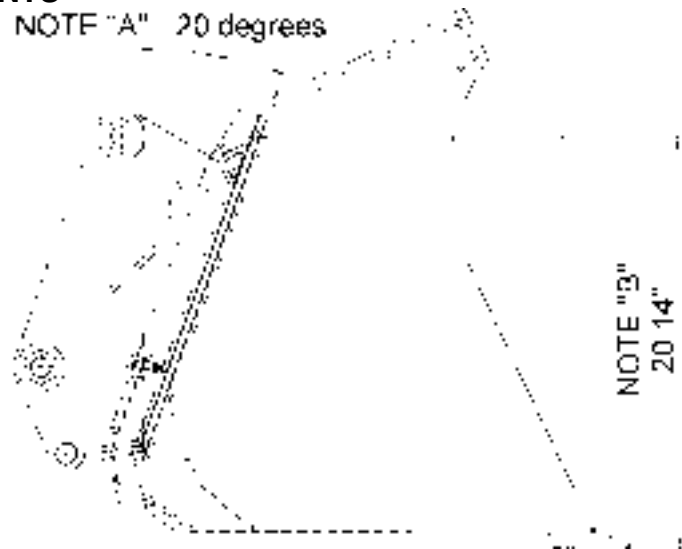

17.3. SKID STEER TOOL CARRIER SYSTEM SERVICE & LUBRICATION

IMPORTANT: To maintain your Skid Steer Tool Carrier System functioning properly, always keep handle components and latching areas clean.

Keep all these areas clean.

Refer to 3 photos at right and below.

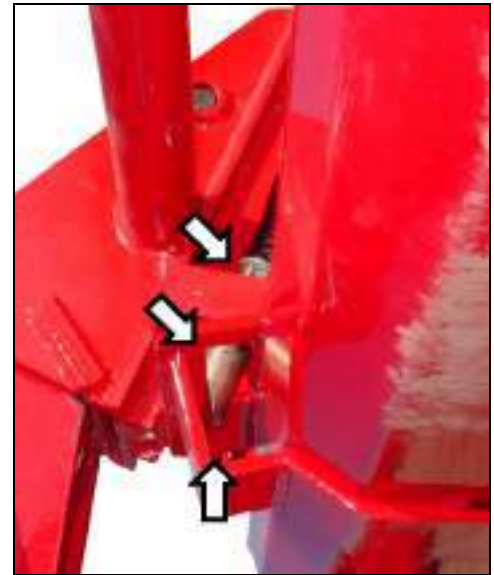

IMPORTANT: To maintain your Skid Steer Quick Attach System functioning properly, always inspect Skid Steer Quick Attach System components for damage or wear. If damage or wear exists, replace components immediately.



17.3.1. Check and tighten this 1/2" bolt after every 20 hours of operation.

17.3.2. A small amount of light oil applied to pins occasionally will improve ease of function of skid steer latching components.

17.3.3. Inspect latching components and groove pins. If damaged, only replace with Factory approved components.

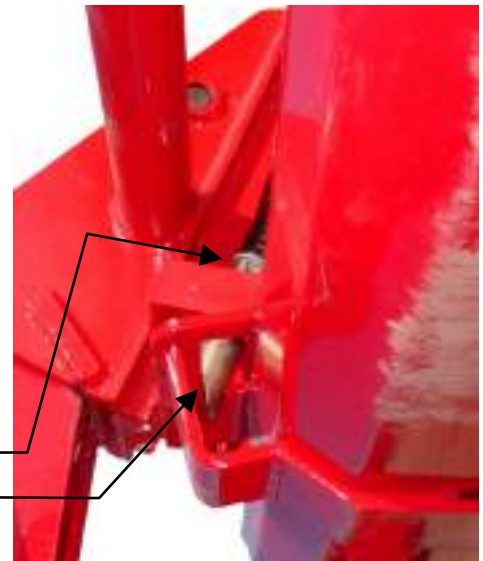
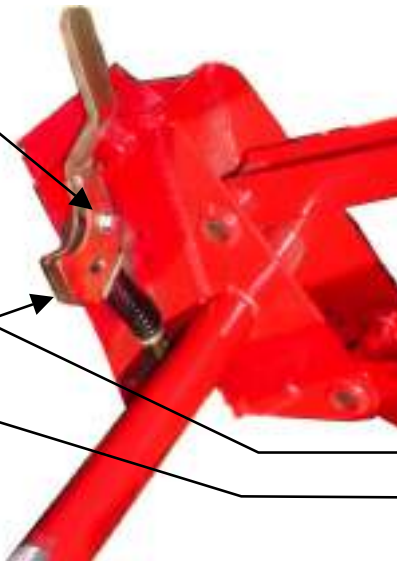

18. INSTALLATION & OPERATION OF SKID STEER TOOL CARRIER SYSTEM

IMPORTANT: Read safety information in this section and on decal before operating attachment.



WARNING

Do not operate without confirmation that coupler pins are fully engaged. Loader attachment can fall off if not properly attached.

To avoid serious injury or death:

- Only use loader manufacturer approved attachments.
- Read all operators manuals and decals before operating. Follow all safety, operating, and service instructions. Contact dealer for replacement parts.

0595-3051



WARNING: Always read and follow operating instructions before operating Skid Steer Tool Carrier System.

18.1. INSTALLATION INSTRUCTIONS

IMPORTANT: Do not extend bucket cylinders without Skid Steer Tool Carrier installed on loader. Failure to follow these instructions could cause loader damage and void warranty.

18.1.1. Install Skid Steer Tool Carrier to loader. Secure as shown.

Top Pin 1-1/8" x 7.01" and E-Clip, 1 place each side.

Bottom Pin 1-1/8" x 7.01" and E-Clip, 1 place each side.

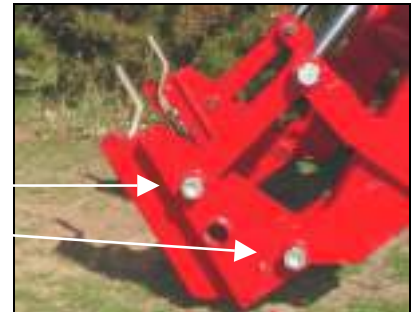

18.2. SKID STEER TOOL CARRIER HANDLES IN DISENGAGED POSITION

18.2.1. To position handles into the handle disengaged position, pull skid steer tool carrier handle upward.

Pull Handles
Upward

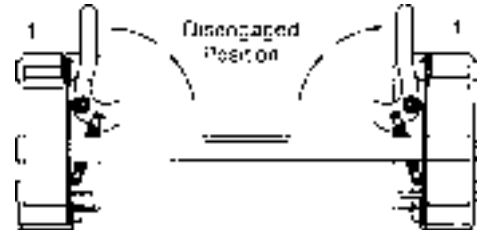

(1) Handles disengaged position.

18.3. SKID STEER TOOL CARRIER HANDLES IN ENGAGED POSITION

18.3.1. To position handles into the handle engaged position, push skid steer tool carrier handle downward until they latch into position.

**Push Handles
Downward.**

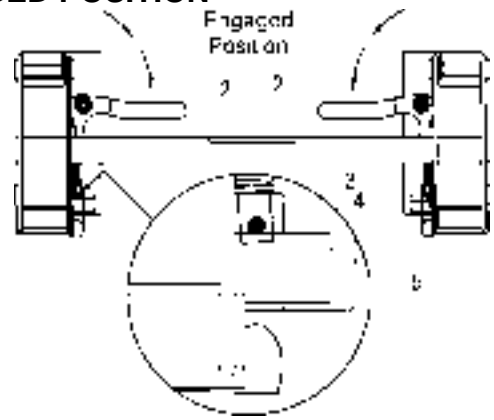

NOTE: Handles should be positioned parallel to ground if properly latched.

IMPORTANT: If properly latched into skid steer tool carrier attachment, the lower skid steer groove pin should be contacting quick attach pin support bar.

- (2) Handles engaged position.
- (3) Groove pin.
- (4) Contact point.
- (5) Pin support bar.

19. INSTALLING BUCKET OR ATTACHMENT TO SKID STEER TOOL CARRIER

IMPORTANT: Refer to Pages 62 to 63 for instructions concerning Skid Steer Tool Carrier Handles Disengaged and Engaged Positions.



CAUTION: Before leaving the tractor seat, stop the engine and lock brakes when installing or removing bucket or attachment.



CAUTION: Do not stand, walk, or work under a raised loader or attachment unless it is securely blocked or held in position. Accidental movement of valve handle/handles or leaks in the hydraulic system could cause the loader to drop, or attachment to dump, causing severe injury.

19.1. OPERATING INSTRUCTIONS

19.1.1. To attach bucket or attachment to loader, lower loader boom to ground with Skid Steer Tool Carrier attachment rolled forward slightly.



19.1.2. To position handles into the handle disengaged position, pull skid steer tool carrier handle upward.

Pull Handles Upward

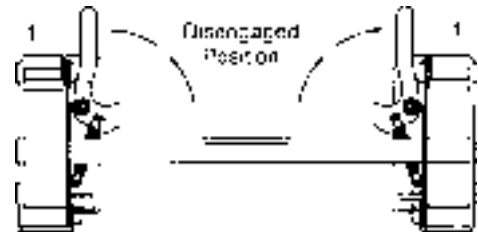

(1) Handles disengaged position.

19.1.3. Roll Skid Steer Tool Carrier attachment forward by extending tilt cylinders just enough to allow Skid Steer Tool Carrier upper vee to engage Skid Steer attachment vee channel. Drive tractor forward, aligning Skid Steer Tool Carrier vee components.

Align Skid Steer Tool Carrier vee with Skid Steer Attachment vee channel.

NOTE: Over extension of tilt cylinders during this operation could cause damage to Skid Steer Tool Carrier handles due to handles contacting bucket or attachment.



19.1.4. When Skid Steer Tool Carrier attachment is aligned with bucket or attachment, raise loader boom slowly making sure Skid Steer Tool Carrier vee components engage. Then roll Skid Steer bucket or attachment back slowly.



19.1.5. Position loader so attachment is approximately 1" off ground.

19.1.6. To position handles into the handle engaged position, push skid steer tool carrier handle downward until they latch into position.

Push Handles Downward.

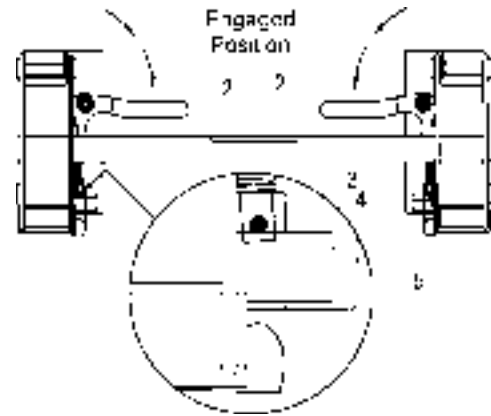

NOTE: Handles should be positioned parallel to ground if properly latched.

IMPORTANT: If properly latched into skid steer tool carrier attachment, the lower skid steer groove pin should be contacting quick attach pin support bar.

- (2) Handles engaged position.
- (3) Groove pin.
- (4) Contact point.
- (5) Pin support bar.

19.1.7. Position loader so attachment is approximately 1" off ground.

1" off ground.



19.1.8. Check that bucket or attachment is securely attached to Skid Steer Tool Carrier by raising loader boom 3 to 4 feet, dumping bucket or attachment against stops, and checking to be sure bottom of bucket or attachment does not roll forward away from Skid Steer Tool Carrier Assembly.

19.1.9. Inspect Skid Steer Tool Carrier attaching areas to verify that Skid Steer Tool Carrier pins have engaged bucket or attachment fully.



19.1.10. Inspect Skid Steer Tool Carrier attaching areas to verify that Skid Steer Tool Carrier pins have engaged bucket or attachment fully.

19.1.11. Skid Steer Quick Attach (1) lower roll pin should be contacting (2) Quick attach pin support bar.

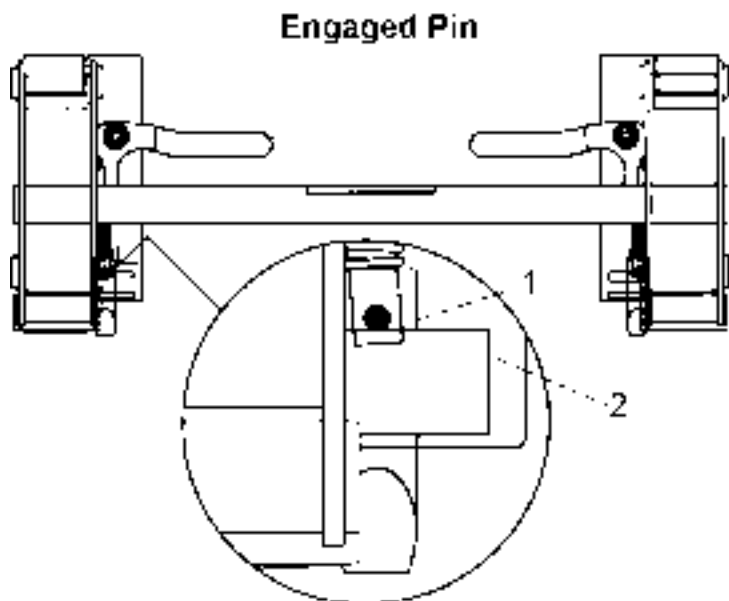

19.1.12. Skid Steer Quick Attach (3) pin should be engaged into (4) bucket or attachment as shown.

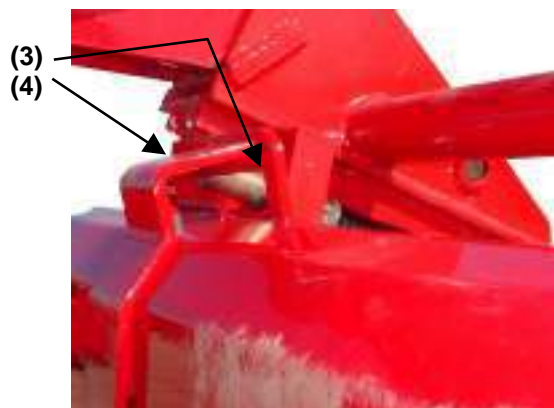

WARNING: A bucket or attachment that is not securely locked into Skid Steer Tool Carrier could come off during loader operation causing serious injury or death.

19.1.13. If installing an attachment utilizing a third cylinder hydraulic circuit, connect loader hose quick couplers at attachment quick couplers.

20. REMOVING BUCKET OR ATTACHMENT FROM SKID STEER TOOL CARRIER

IMPORTANT: Refer to Pages 62 to 63 for instructions concerning Skid Steer Tool Carrier Handles Disengaged and Engaged Positions.



CAUTION: Before leaving the tractor seat, stop the engine and lock brakes when installing or removing bucket or attachment.



CAUTION: Do not stand, walk, or work under a raised loader or attachment unless it is securely blocked or held in position. Accidental movement of valve handle/handles or leaks in the hydraulic system could cause the loader to drop, or attachment to dump, causing severe injury.

20.1. OPERATING INSTRUCTIONS

20.1.1. To disconnect bucket or attachment from loader, position bucket or attachment slightly rolled back and approximately 1" off of ground.



20.1.2. To position handles into the handle disengaged position, pull skid steer tool carrier handle upward.

Pull Handles Upward

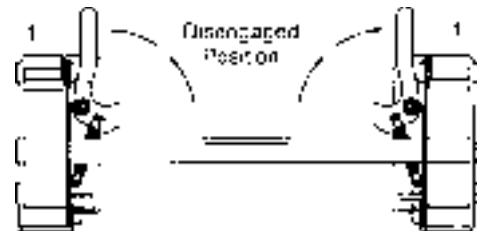

(1) Handles disengaged position.

20.1.3. Roll bucket or attachment forward and lower to ground. Back loader away from bucket or attachment.

NOTE: Over extension of tilt cylinders during this operation could cause damage to Skid Steer Tool Carrier handle due to handle contacting bucket or attachment.



20.1.4. If removing an attachment utilizing a third cylinder hydraulic circuit, disconnect loader hose quick couplers from attachment quick couplers. Secure and store loader hoses on loader frame.

21. SKID STEER BUCKET

IMPORTANT: Read safety information in this section and on decals before operating attachments.

WARNING: To avoid serious injury or death from large round or square hay bale handling:



- Use only Factory bale spear or bale retaining device handler attachment when handling round bales.
- Do not handle large square bales without a retaining device handler attachment
- Do not use buckets, forks, or other attachments without bale retaining devices.
- Do not use loader for handling large, heavy objects such as logs, tanks, etc.

WARNING: To avoid serious injury or death, realize handling large heavy objects can be extremely dangerous due to:



- Danger of rolling the tractor over.
- Danger of upending the tractor.
- Danger of the object rolling or sliding down the loader arms onto the operator.

WARNING: To avoid serious injury or death:



- Do not lift or carry anyone on buckets, forks, probes, or any other portion of the loader or loader attachments.
- Avoid contact with electrical power lines by loader or attachment



WARNING: Inadvertent movement of the loader or attachment could result in serious injury or death.

21.1. SKID STEER BUCKET



21.2. INSTALLATION INSTRUCTIONS TO SKID STEER TOOL CARRIER



IMPORTANT: Refer to Pages 64 to 66 for instructions concerning Installing Attachment to Skid Steer Tool Carrier.

IMPORTANT: Refer to Page 67 for instructions concerning Removing Attachment from Skid Steer Tool Carrier.

22. SKID STEER BALE SPEAR

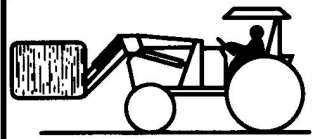

CAUTION

To avoid serious injury or death:

- Read operators manual and decals before operating. Follow all safety, operating, and service instructions. Contact dealer for replacement.
- Be careful during loading, transporting, and stacking to minimize rolling bales and tractor tip over.
- ROPS (Roll-Over Protective Structures) and seat belt equipped tractors are recommended for operator use in all bale probe operations.
- Do not allow riders on tractor, loader, or bale probe.
- Avoid loading/unloading bales on sloping or uneven surfaces.
- Avoid transporting with bales raised high. Keep bales tilted back and low to the surface while moving.
- Approach, penetrate, and transport bales at low speeds. Reduce speeds on curves, hills, rough ground, or when turning.
- Do not lift anything with bale probe except round bales.
- Never raise round bale to full height with bale probe rolled back.
- Park and store bale probe points pointed against bale, building, or other stable object.

0595-3054

IMPORTANT: Read safety information in this section and on decals before operating attachments.



DANGER



To avoid serious injury or death:

- Unload only on a level surface.
- Keep bystanders clear of work area when loading and unloading bales.

0595-3050



CAUTION

To prevent bodily injury and loader instability when detaching loader, equip loader with a material bucket or a manure fork.

0595-2190



IMPORTANT: It is not recommended that loader be detached with bale spear attached. Loaders will park safely; however, bale spear could be damaged during parking. Always detach loader with bucket or other loader Factory approved attachment attached.



CAUTION: When transporting a round bale, tilt the bale spear slightly back from level and carry the load in a low position.



CAUTION: Never raise round bale to full height with bale spear rolled back as serious injury or death could occur.



CAUTION: To prevent bodily injury, park and store bale spear with points pointed against bale, building, or other stable object.

22.1. SKID STEER BALE PROBE

IMPORTANT: This spear is a high strength alloy – drop forged steel and should not be welded or heat-treated.

IMPORTANT: Maximum load limit on super penetrator bale spear is 2,000 pounds.

22.2. ASSEMBLY INSTRUCTIONS

22.2.1. Install Bale Spear into tapered sleeve and secure with nut. Torque nut 515 ft. lb. Failure to follow these instructions could cause damage to spear and void your warranty.

(1) Upper Spear.

Flat surface of spear located upward.

(2) Tapered Sleeve.

(3) Upper Spear Nut, 28mm.

Torque nut to 515 ft. lb.

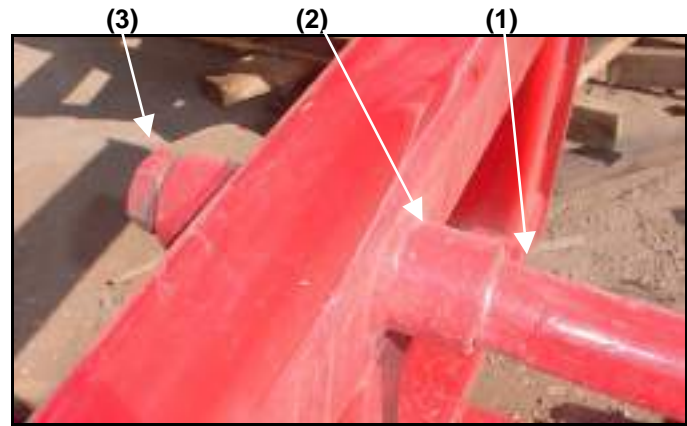

22.3. INSTALLATION INSTRUCTIONS TO SKID STEER TOOL CARRIER

IMPORTANT: Refer to Pages 64 to 66 for instructions concerning Installing Attachment to Skid Steer Tool Carrier.

IMPORTANT: Refer to Page 67 for instructions concerning Removing Attachment from Skid Steer Tool Carrier.

22.4. OPERATING INSTRUCTIONS

22.4.1. With bale spear level with ground, slowly spear bale slightly above center.



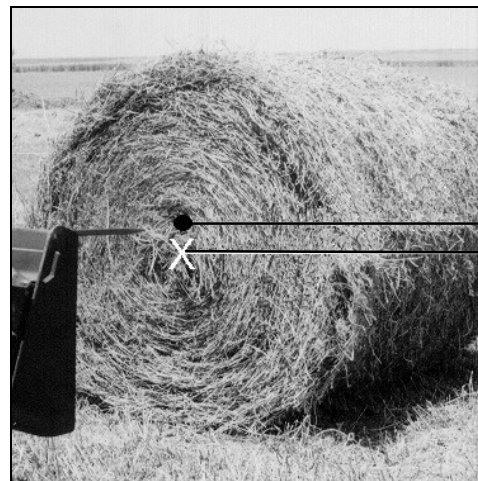

22.4.2. With all three spears completely engaged into bale, tilt bale spear slightly back from level and transport the load in a low position.



Spear bale slightly above center of bale.

23. SKID STEER PALLET FORK

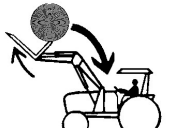
IMPORTANT: Read safety information in this section and on decals before operating attachments.

	 <h3>WARNING</h3>	<ul style="list-style-type: none"> • Always keep pallet forks level when raising loads. • Avoid raising loads to full heights with pallet forks rolled back. • ROPS (Roll-Over Protective Structures) and seat belt equipped tractors are recommended for operator use in all pallet fork operations. • Do not lift or carry anyone on buckets, forks, probes, or any other portion of the loader or loader attachments. • Do not allow riders on tractor, loader, or forks. • Avoid contact with electrical power lines by loader or attachments.
	<p>To avoid serious injury or death:</p>	
	<ul style="list-style-type: none"> • Do not use pallet fork attachment to lift large objects, round bales, or items that may roll or slide down loader arms onto the operator. • Never operate pallet fork without attaching plate guard. • Keep loads below pallet forks attaching plate guard heights. • Always transport loads with pallet forks low and level to ground. 	

0595-3052

 <h3>CAUTION</h3>
<p>Maximum load limit on combined pair of forks is 5700 pounds.</p> <p style="text-align: right;">0595-3053</p>



 <h3>CAUTION</h3>
<p>To prevent bodily injury and loader instability when detaching loader, equip loader with a material bucket or a manure fork.</p> <p style="text-align: right;">0595-2190</p>

 **WARNING:** The pallet fork attachment is specifically designed to engage and load palletized materials. Do not use forks to handle large loads such as bales, posts, etc. as they can fall or roll back onto operator causing serious injury or death.

23.1. SKID STEER PALLET FORK

23.1.1. The Skid Steer Pallet Fork has two tines each 1-1/2" x 4" x 42".

23.2. ASSEMBLY INSTRUCTIONS

23.2.1. Install (4) guard to (7) pallet fork frame using (5) 1-2" x 1-1/2" bolt, lockwasher, flatwasher, and nut, 2 places each side.

23.2.2. Install (3) forks to (7) pallet fork frame using (1) pins, 2 places secure using (2) 3/8" x 2-1/2" bolts, lockwashers, and nuts, 4 places.

23.2.3. Locate (6) hooks on (3) forks on backside of angle to prevent fork rotation.

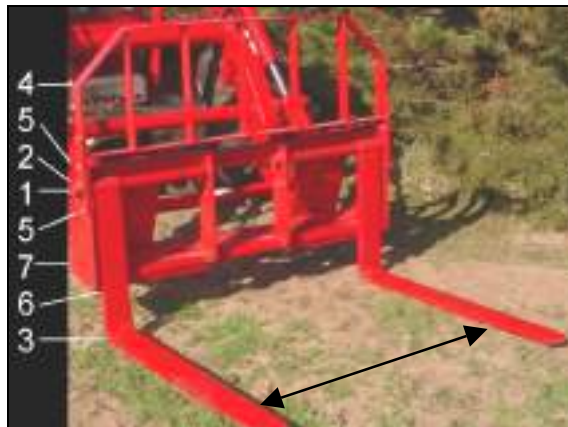

23.3. INSTALLATION INSTRUCTIONS TO SKID STEER TOOL CARRIER

IMPORTANT: Refer to Pages 64 to 66 for instructions concerning Installing Attachment to Skid Steer Tool Carrier.

IMPORTANT: Refer to Page 67 for instructions concerning Removing Attachment from Skid Steer Tool Carrier.

23.4. OPERATING INSTRUCTIONS

The operator must keep the load centered and as far back on the forks as possible. Operator must always keep load level. Carry the load low and at a slow speed.

23.5. PARKING INSTRUCTIONS

If parking loader from tractor with pallet fork attachment, move forks outward to widest position (see photo above).

NOTE: Move Forks outward to Widest Position

24. TROUBLE SHOOTING PROCEDURES

This Trouble Shooting Chart is provided for reference to possible loader operational problems.

Determine the problem that best describes the operational problem being experienced and eliminate the possible causes as listed by following the correction procedures.

For further assistance contact your dealer.

24.1. TROUBLE SHOOTING FOR ALL LOADERS

PROBLEM	POSSIBLE CAUSE	CORRECTION
Lift and Tilt Cylinders inoperative	Low hydraulic fluid level.	Check and replenish hydraulic fluid.
	Hydraulic hoses connected improperly.	Check and correct hydraulic hose connections
	Hydraulic Hoses to/from loader valve blocked.	Check for damaged (kinked) hoses, etc.
	Loader valve or tractor main relief valve stuck open.	Check system pressure. Repair or replace relief valve.
	Low system pressure supplied from hydraulic pump.	Check system pressure. Repair or replace pump.
	Loader valve linkage broken.	Inspect. Repair as required.
	Quick disconnect coupler(s) are not fully connected.	Check coupler connections. Replace coupler(s) if necessary.
	Hydraulic hose or tubeline blockage.	Check all hoses and tubes for leaks, damage, or restrictions. Replace damaged or restricted hoses or tube lines.
Lift and/or tilt cylinders operate in wrong direction relative to valve handle position	Cylinder piston assembly defective (not sealing).	Check cylinders for internal leakage as described in service section under cylinder leakage tests.
	Loader valve blockage.	Inspect for blockage. Disassemble valve if necessary.
Attachment will dump but will not rollback	Hydraulic hoses connected incorrectly.	Correct hydraulic hose connections.
Slow or erratic lift	Hydraulic circuit connected incorrectly.	Refer to plumbing diagram on Page 32 and correct hose connections.
	Low hydraulic fluid level.	Check and replenish hydraulic fluid.
	Cold hydraulic fluid.	Allow hydraulic system to warm up to operating temperature.
	Engine R.P.M. too slow (hydraulic pump R.P.M. too slow).	Increase engine speed to obtain satisfactory loader operation.
	Excessive weight in bucket. Material weight exceeds maximum specified loader capacity.	Reduce material load.
	Loader valve linkage binding/defective.	Check loader valve linkage and repair if worn/defective.

PROBLEM**POSSIBLE CAUSE****CORRECTION**

	Aeration of hydraulic fluid	Refer to "Aeration of Hydraulic Fluid".
	Quick disconnect coupler restriction or coupler.	Check coupler connections. Repair or replace.
	Hydraulic hose or tubeline restriction (hoses/tubeline kinked or pinched).	Check hoses and tubelines for evidence of restriction.
	Lift cylinder piston assembly leakage.	Check cylinders for leakage. Repair as needed.
	Relief valve erratic or set below specifications.	Check and reset relief valve setting as needed.
	Loader valve leaking internally. (Bypassing fluid within valve.)	Replace loader valve and recheck operation.
	Inadequate hydraulic pump capacity.	Refer to "Hydraulic Pump Capacity Inadequate".
Inadequate lifting capacity	Engine R.P.M. too slow.	Increase engine R.P.M.
	Excessive load – material weight exceeds specified loader capacity.	Reduce Load.
	Relief valve setting below specifications.	Check and reset relief valve setting as needed.
	Lift cylinder piston assembly leakage.	Check cylinders for leakage. Repair as needed.
	Loader valve leaking internally.	Replace loader valve and recheck operation.
	Hydraulic pump defective.	Refer to "Hydraulic Pump Capacity Inadequate".
Aeration of Hydraulic Fluid (generally indicated by foamy appearance of fluid).	Low hydraulic fluid level.	Check and refill hydraulic system to proper level.
	Air leaking into suction side of hydraulic pump.	Check for loose or defective connections between reservoir and hydraulic pump.
	Hydraulic fluid foaming due to improper hydraulic oil usage.	Refer to Tractor Operator's Manual and replace hydraulic oil using recommended hydraulic oil.
System relief valve squeals.	Cold Hydraulic Fluid.	Allow hydraulic fluid to warm up to operating temperature.
	Excessive load in bucket. Weight exceeds specified loader capacity.	Reduce load.
	Relief valve setting below specifications.	Check and reset valve setting as needed.
	Hydraulic hose, tubeline, or quick disconnect coupler restriction.	Check for evidence of restriction in hydraulic oil flow. Repair or replace defective components.

PROBLEM	POSSIBLE CAUSE	CORRECTION
Loader drops with loader valve spool in "Centered" position (no external oil leakage evident.)	Cylinder Piston assembly leakage.	Check cylinders for leakage.
	Loader valve internal leakage. Note: A gradual drop over an extended period of time is a normal condition.	Replace loader valve and recheck.
Loader valve spool(s) will not return to centered position.	Valve handle linkage binding.	Determine origin of binding and repair.
	Loader valve spool centering is broken.	Replace centering spring.
	Loader valve spool binding in valve body spool bore.	Disassemble valve for inspection and repair.
Loader bucket moves freely after dumping load	Tilt cylinder cavitation has occurred.	Use of regen function while dumping load will eliminate problem. Refer to Page 32. Contact Factory for optional orifice kit availability.
External hydraulic fluid leakage.	Loose hydraulic connection.	Tighten loose connections.
	Defective hydraulic hose, tubeline, adapter fitting or adapter fitting o-ring.	Check for origin of oil leak and replace defective part.
	Loader valve o-rings defective.	Replace defective o-rings.
	Loader valve spool or body damaged or worn.	Replace loader valve.
	Cylinder rod packing set leakage.	Check cylinders for leakage. Repair as needed.
Hydraulic pump capacity inadequate.	Cold hydraulic fluid.	Allow hydraulic fluid to warm up to operating temperature.
	Engine R.P.M. too slow.	Increase engine R.P.M.
	Low hydraulic fluid supply.	Refer to Tractor Operator's Manual for service recommendations.
	Hydraulic hose restriction.	Check for evidence of restriction in hydraulic hoses.
	Hydraulic pump defective.	Refer to Tractor Operator's manual for recommended service procedures. Replace hydraulic pump if determined to be defective.
Lift cylinder rods bend when lift cylinders extended.	Excessive shock load on lift cylinders during transport.	Replace defective parts. Review and observe proper and safe operational practices.
Bucket cutting edge wear is uneven side to side	Bucket is not level to ground.	Check rear tire inflation and adjust to level bucket to ground.

PROBLEM

Bucket cutting edge wear rate is excessive. (Wear rate is even across full width of bucket).

POSSIBLE CAUSE

Incorrect operational practices.
Excessive down pressure placed on bucket when used on hard abrasive surfaces.

Bucket wear pads worn.

Note: Extensive use of bucket on concrete or asphalt surfaces will accelerate wear rate of bucket cutting edge.

CORRECTION

Refer to operation – scraping section for correct operating procedures. Utilize float position.

Replace wear pads.

Loader is slow and/or will not dump.

Hydraulic oil too heavy.

Change to proper oil.

Oil filter plugged.

Clean or replace filter.

Hydraulic pump worn.

Repair or replace pump.

Oil line restricted or leaking.

Check all hoses and tubes for leaks, damage, or restrictions. Replace damaged or restricted hoses or tube lines.

Loader valve does not shift properly.

Inspect clean, repair, or replace valve.

Cylinder leaks internally.

Replace seals.

Faulty valve.

Repair or replace valve.

Loader chatters or vibrates when raising or lowering.

Air in hydraulic system.

Cycle lift cylinders and tilt cylinders.

Slow leakdown.

Oil level too low.

Add oil as required.

Worn loader valve.

Have authorized Mahindra dealer replace seals.

Worn cylinder piston seals.

Have authorized Mahindra dealer replace seals.

Attachment will dump but will not rollback

Hydraulic circuit connected incorrectly.

Check that Port "C" of loader valve is connected to tilt cylinder base end and that Port "D" of loader valve is connected to rod end of tilt cylinder.

24.2. TROUBLE SHOOTING FOR LOADERS WITH OPTIONAL SELF LEVELING

PROBLEM	POSSIBLE CAUSE	CORRECTION
Bucket does not self-level	Bad float switch in the valve handle.	Repair or replace the handle and switch.
	On-Off Solenoid Valve stuck in the ON position.	Check the Solenoid Valve on Self Level Valve.
Bucket does not maintain level while raising or lowering at engine speeds other than high idle.	Bucket self-leveling is designed to work optimally at high RPM.	Run engine at high RPM (1700 or above).
	Loader valve lift spool not fully stroked.	Fully stroke the loader lift spool.
Bucket does not maintain level while raising at high idle.	Flow divider spool stuck.	*Check flow divider spool for free operation. (Check for contamination.)
	Raise counterbalance valve stuck.	*Remove and check for contamination.
Bucket does not maintain level while lowering at high idle.	Flow divider spool stuck.	*Check flow divider cartridge for free operation.
	Lower modulator valve stuck.	*Remove and check for contamination. (Spool should move freely in bore.)
	Lift check valve stuck (cartridge).	*Remove and check for contamination.
Excessive bucket drift in the dump direction.	Bad bucket cylinder seal.	Repack cylinder.
	Raise counterbalance valve stuck.	*Remove and check for contamination.
	Bad Anti-Cavitation relief valve cartridge.	*Check Anti-Cavitation check valve cartridge. Remove and check for contamination or replace.
	Excessive loader control valve bucket spool port leakage.	Check with Factory on acceptable valve spool leakage rate. Replace if required.
Bucket moves freely when putting down pressure on cutting edge.	Pilot operator check is not closing (cartridge plus pilot piston).	*Remove and check for contamination. Replace if required.
Loader bounces with lowering load.	Low hydraulic flow.	Increase tractor RPM to increase hydraulic flow.
Self-Leveling does not operate after initial hook-up.	Circuit not hooked up correctly.	Check that circuits are hooked up as follows.



Self Level Valve Ports to Loader Valve	Self Level Valve Ports to Loader Cylinders	Circuit	Color Tag
1	5	Lift Base	Green
2	6	Lift Rod	Blue
3	7	Tilt Base	Yellow
4	8	Tilt Rod	Red

***NOTE: This service must only be accomplished by an Authorized Mahindra Service Person. Failure to follow these instructions will void warranty.**

25. TORQUE CHART

SAE FASTENER TORQUE CHART



NOTE: Use these torques, unless other torques are specified. Values are for UNF and UNH thread fasteners, plated or unplated, as received from supplier. Fasteners can be dry or lubricated with normal engine oil. Values do not apply if graphite, moly disulfide or other extreme pressure lubricant is used.

SAE Grade No.	2				5				8*			
												
Bolt Size	LB FT		Nm		LB FT		Nm		LB FT		Nm	
	Min	Max	Min	Max	Min	Max	Min	Max	Min	Max	Min	Max
1/4	5	8	7	8	9	11	12	15	12	15	16	20
5/16	10	12	14	16	17	20.5	23	29	24	29	32	36
3/8	20	23	27	31	35	42	48	57	45	54	57	73
7/16	30	35	41	47	54	64	73	87	70	84	95	114
1/2	45	52	61	70	80	96	107	130	110	132	149	179
9/16	65	75	88	102	110	132	149	179	160	192	217	260
5/8	85	100	120	142	150	180	203	244	220	264	298	358
3/4	150	185	205	251	270	324	364	439	380	464	515	618
7/8	180	205	217	271	400	480	542	651	600	720	814	976
1	250	300	309	400	580	680	787	944	900	1060	1200	1454
1-1/8					850	980	1085	1293	1280	1440	1635	1950
1-1/4					1120	1240	1519	1681	1820	2000	2458	2712
1-3/8					1400	1600	1860	2278	2380	2720	3077	3586
1-1/2					1840	2000	2631	2980	3100	3520	4290	4877

NOTE: Bolt head identification marks as per grade. Manufacturing marks will vary. *Flock nuts must be used with Grade 8 bolts.

METRIC FASTENER (ISO) TORQUE CHART

NOTE: Use these torques, unless other torques are specified. Values are for coarse thread fasteners, plated or unplated, as received from supplier. Fasteners can be dry or lubricated with normal engine oil. Values do not apply if graphite, moly disulfide or other extreme pressure lubricant is used.

ISO Class No.	8.8				10.9				12.9			
												
Bolt Size	Nm		LB FT		Nm		LB FT		Nm		LB FT	
	Min	Max	Min	Max	Min	Max	Min	Max	Min	Max	Min	Max
M4	3	4	3	3	4	5	3	4				
M5	5.5	8	5	8	8.5	11	7	9				
M6	10.5	12	8	9	15	17.5	11	13				
M8	26	31	18	23	37	43	27	32				
M10	52	61	38	45	75	87	51	64				
M12	90	107	66	79	125	150	90	112				
M14	154	172	110	127	200	245	149	178				
M16	217	271	150	200	310	380	250	290				
M20	444	510	320	380	610	730	450	540				
M24	675	810	500	600	1050	1270	780	940				
M30	1250	1500	920	1100	2000	2400	1470	1770				
M36	2175	2600	1600	1900	3600	4300	2680	3200				

NOTE: Bolt head identification marks as per grade. Manufacturing marks will vary.

Because of the low ductility of these fasteners, the torque range is to be determined individually for each application. As a general rule, the torque ranges specified for grade 10.9 fasteners can be used satisfactorily on 12.9 fasteners.

*M14 is not a preferred size.