

OPERATOR'S MANUAL

KUBOTA TRACTOR

MODEL

B5100D·B5100E

B6100D·B6100E

B7100D



F-1920

LINE NO.		40251		SERIAL NO.		66701-67019	
QTY.		1		DESCRIPTION		B-SERIES OWNERS	
CITY, STATE		OTT, MISS		SALES PRICE		6006.01	
CITY, STATE		OTT, MISS		CITY, STATE		OTT, MISS	
CITY, STATE		OTT, MISS		CITY, STATE		OTT, MISS	
CITY, STATE		OTT, MISS		CITY, STATE		OTT, MISS	
CITY, STATE		OTT, MISS		CITY, STATE		OTT, MISS	
CITY, STATE		OTT, MISS		CITY, STATE		OTT, MISS	
CITY, STATE		OTT, MISS		CITY, STATE		OTT, MISS	
CITY, STATE		OTT, MISS		CITY, STATE		OTT, MISS	

READ AND SAVE THIS BOOK





SAFETY ALERT SYMBOL

This is the industry "Safety Alert Symbol". This symbol is used to call your attention to items or operations that could be dangerous to you or other persons using this equipment. Please read these messages and follow these instructions carefully.

It is essential that you read the instructions and safety regulations before you attempt to assemble or use this unit.



WARNING

TO AVOID PERSONAL INJURY:

1. Keep PTO shield in place at all times.
2. Do not operate the PTO at speeds faster than the speed recommended by the implement manufacturer.



CAUTION

TO AVOID PERSONAL INJURY:

1. Read and understand operator's manual before attempting to start or operate the tractor.
2. Before starting engine, make certain everyone is at a safe distance from machine and PTO is OFF.
3. Never permit passengers on tractor.
4. Before dismounting, stop engine, set park brake, and lower implement to the ground.
5. Keep all shields in place and stay away from all moving parts.
6. Slow down for turns, rough roads, and when applying individual brakes.
7. Lock the brake pedals together for road travel.
8. On public roads use SMV emblem and warning lights.
9. Always attach towed loads to the tractor drawbar.



FOR SAFE OPERATION

Read these safety tips. Improper use of the tractor and its equipments can result in injury. To reduce this possibility, pay complete attention to the job at hand, and observing the following cautions. If you can prevent an accident, your time will have been spent well.

1. Fuel Supply and Starting Engine

- (1) Always stop the engine before refueling.
- (2) To avoid the danger of exhaust fume poisoning, do not operate the engine in a closed building without proper ventilation.
- (3) Before starting the engine, sit in the seat, disengage the clutch, and place shift levers in the neutral position. Fasten seat belt if equipped with ROPS.
- (4) Before starting the tractor, check to see that there are no people around.
- (5) Before driving the tractor in reverse, check to see that there are no obstacles around.

2. Operation

- (1) Unreasonable operation such as on dangerous terrain, beyond the load capacity or beyond the intended use of the tractor must be avoided as it may cause the tractor to tip over. Refer to "The Superior Limit of Implement" on page 2 which outlines the maximum loads for safe tractor operation.
- (2) For your safety ROPS with a seat belt is recommended by KUBOTA for most applications. Check operator's manual and discuss with your local dealer.



CAUTION:

- Always use seat belt when the tractor is equipped with a ROPS. Never use the seat belt when the tractor is not equipped with a ROPS.

(ROPS: Roll-Over Protective Structures)

- (3) Keep all safety covers in place.
- (4) When working in cooperation with other tractors, let the other drivers know what you are doing.
- (5) Keep people away from the tractor during operation.
- (6) When using an implement, be sure to install the proper ballast weight on the tractor.

3. Loading and Unloading

- (1) Securely fix a rugged ramp with non-skids and check to see that there are no people around before starting to load or unload.
- (2) When loading or unloading, chock or block the truck tires.

4. Traveling

- (1) Before traveling on the road, be sure to interlock the two brake pedals.
- (2) If descending a slope, never disengage the clutch or shift levers to neutral to avoid overspeeding.
- (3) When traveling on the public road, observe the traffic regulations.

- (4) Always slow down the tractor before turning. Turning at a high speed may tip the tractor over.
- (5) Do not drive with your foot resting on the clutch pedal.
- (6) Do not apply the differential lock while traveling.
- (7) Before operating, widen the rear wheel tread to the outermost recommended position for better stability.
- (8) When you drive the tractor with the cabin on public road, you should equip the rear view mirror, which the ASAE standard provides. But when your tractor has no cabin, please consult with your local dealer if the rear view mirror is necessary.

5. Operating with Implement

When installing or using the implement, be sure to read the instruction for the implement and keep precautions in mind.

6. Other Operating Cautions

- (1) Never operate the tractor or any agricultural equipment while under the influence of alcohol or other drugs, or while under fatigue.
- (2) Avoid driving the tractor in loose, bulky clothes.
- (3) Check, service and clean the tractor after stopping the engine, follow the directions of the Operator's Manual.
- (4) Avoid touching the muffler and the radiator during or immediately after operating.
Service or check the tractor after it has completely cooled off.
- (5) When working in the fields or muddy areas, be sure to scrape off mud or soil from the bottom of your shoes before mounting the tractor.
- (6) Before allowing other people to use your tractor, explain how to operate and lend this manual beforehand.
- (7) Read the implement operator's manual to insure safe operating procedures.
- (8) Only use 2nd or 3rd PTO gear if such speed is recommended in label, implement manual, or other instructions.
Otherwise, use only 1st PTO gear speed (8.6 r/s; 514 rpm).
- (9) Keep first aid kit and fire extinguisher near by at all times.
- (10) Never pull from the top link, the rear axle or any point above the drawbar.
Doing so could cause the tractor to tip over rearward causing personal injury.
For pulling, attach to the drawbar (fixed or swinging type). Use the 3-point hitch only with equipment designed for 3-point hitch usage.

7. Tractor Safety Labels

① Part No. 35260-3491-1



CAUTION

TO AVOID PERSONAL INJURY:

1. Read and understand operator's manual before attempting to start or operate the tractor.
2. Before starting engine, make certain everyone is at a safe distance from machine and PTO is OFF.
3. Never permit passengers on tractor.
4. Before dismounting, stop engine, set park brake, and lower implement to the ground.
5. Keep all shields in place and stay away from all moving parts.
6. Slow down for turns, rough roads, and when applying individual brakes.
7. Lock the brake pedals together for road travel.
8. On public roads use SMV emblem and warning lights.
9. Always attach towed loads to the tractor drawbar.

② Part No. 35260-2979-1



WARNING

TO AVOID PERSONAL INJURY:

1. Attach pulled or towed loads to the drawbar only.
2. Use the 3-point hitch only with equipment designed for 3-point hitch usage.

③ Part No. 35260-2978-1



CAUTION

TO AVOID PERSONAL INJURY:

1. Roll-Over Protective Structure (ROPS) with a seat belt is recommended by KUBOTA in most applications. Check operator's manual and discuss with your local dealer.
2. Always use seat belt when the tractor is equipped with Roll-Over Protective Structure (ROPS). Never use seat belt when the tractor is not equipped with ROPS.

④ Part No. 35200-2534-1



WARNING

TO AVOID PERSONAL INJURY:

1. Keep PTO shield in place at all times.
2. Do not operate the PTO at speeds faster than the speed recommended by the implement manufacturer.

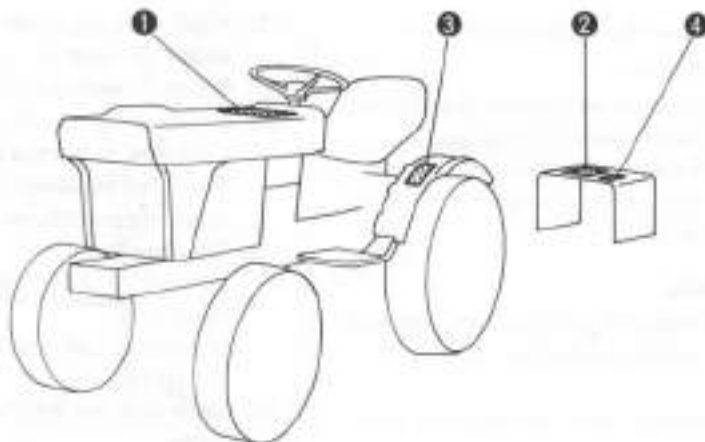

CARE OF SAFETY SIGNS

- (1) Keep safety signs clean and free from obstructing material.
- (2) Clean safety signs with soap and water, dry with a soft cloth.
- (3) Replace damaged or missing safety signs with new safety signs from your Kubota dealer.
- (4) If a component with safety sign(s) affixed is replaced with new part, make sure new safety sign(s) is (are) attached in the same location(s) as the replaced component.
- (5) Mount new safety signs by applying on a clean dry surface and pressing any bubbles to outside edge.

Specifications

Model:	B5100D	B5100E	B6100D	B6100E	B7100D	
Engine:	KUBOTA Z500-1A		KUBOTA D650-A		KUBOTA D750-A	
Type	Vertical, water-cooled, 4-cycle engine					
Cylinders	2		3			
Total displacement	508cm ³ (31 cu.in.)		675cm ³ (41.2 cu.in.)		762cm ³ (46.5 cu.in.)	
Bare horse power and speed	8.8 kW at 50 r/s (12 HP at 3000 rpm)		10.3 kW at 46.7 r/s (14 HP at 2800 rpm)		11.7 kW at 46.7 r/s (16 HP at 2800 rpm)	
Cylinder bore and stroke	68 x 70mm (2-5/8 x 2-3/4 in.)		64 x 70mm (2-1/2 x 2-3/4 in.)		68 x 70mm (2-5/8 x 2-3/4 in.)	
Fuel	High speed diesel fuel or No. 2 diesel fuel					
Starter	Electric starter with battery, glow plug and decompression device, 12V, 0.8 kW					
Lubrication	Forced lubrication by trochoidal pump					
Cooling	Water with pressurized radiator (natural circulation)					
Battery	12V 35Ah		12V 45Ah			
Fuel tank cap.	8 ℓ (2.1 gals.)		13 ℓ (3.4 gals.)			
Engine oil case cap.	2.3 ℓ (2.4 qts.)		3.9 ℓ (4.1 qts.)			
Engine coolant cap.	3 ℓ (3.2 qts.)		4.6 ℓ (4.9 qts.)			
Transmission oil case cap.	8.5 ℓ (9.0 qts.)		11.5 ℓ (12.2 qts.)			
Dimensions:						
Overall length	1820mm (71-5/8 in.)		1950mm (77-3/16 in.)		2000mm (78-3/4 in.)	
Overall width	820mm (36-1/4 in.) (tire outer width)		975mm (38-3/8 in.) (tire outer width)	930mm (36-5/8 in.) (tire outer width)	1015mm (40 in.) (tire outer width)	
Overall height	1120mm (44-1/16 in.)		1135mm (44-5/8 in.)	1145mm (45-1/8 in.)	1155mm (45-1/2 in.)	
Wheel base	1180mm (46-7/16 in.)		1250mm (49-1/4 in.)	1240mm (48-13/16 in.)	1250mm (49-1/8 in.)	
Minimum ground clearance	220mm (8-5/8 in.) (to front axle)	260mm (10-1/4 in.) (to transmission case bottom)	250mm (9-7/8 in.) (to transmission case bottom) 240mm (9-1/2 in.) (to front axle)	250mm (9-7/8 in.) (to transmission case bottom)	290mm (11-3/8 in.) (to transmission case bottom) 240mm (9-1/2 in.) (to front axle)	
Treads	Front	670mm (26-3/8 in.)	660mm (26 in.)	785mm (30-7/8 in.)	790mm (31-1/8 in.)	825mm (32-31/64 in.)
	Rear	640mm, 740mm (25 in., 29 in.)		650mm, 700mm (25-19/32 in., 27-9/16 in.)		
Tires	Front	4.50-10-2PR (18 x 6.5 - 8)	4.00-9-2PR (18 x 8.5 - 8)	6-12-2PR (20.5 x 8.00 - 10)	4.00-9-2PR (20 x 8.00 - 10) 6.90-6-2PR (20.5 x 8.00 - 10)	6-12-2PR (20.5 x 8.00 - 10)
	Rear	7-16-4PR (27 x 8.50 - 15)		7-16-4PR (27 x 8.50 - 15)	7-16-4PR (29 x 12.00 - 15) (27 x 8.50 - 15)	8-16-4PR (29 x 12.00 - 15)
Weight:	405 kg (893 lbs.)	385 kg (805 lbs.)	470 kg (1036 lbs.)	440 kg (970 lbs.)	490 kg (1080 lbs.)	
PTO shaft:						
Location	Transmission case rear 1 (Engine front 1)					
Ground clearance	450mm (17-13/32 in.)		445mm (17-1/2 in.)		490mm (19-1/4 in.)	
Revelution direction	Right viewed from rear					
Revelution	2 steps (10.1, 16.1 r/s at 50.0 engine r/s) (603, 963 rpm at 3000 engine rpm)		3 steps (8.6, 14.6 and 25.0 r/s at 46.7 engine r/s) (514, 876 and 1498 rpm at 2800 engine rpm)			
Clutch:	Dry single plate type					
Steering:	Ball screw type					
Transmission:	Gear shift					
Speed changes:	6 forward, 2 reverse					
Minimum turning radius:	1.68m (66 in.)	1.65m (65 in.)	1.85m (73 in.)	1.75m (69 in.)	1.9m (75 in.)	
Brake:	Internal-expanding type, right and left independent with interlocking device					
Differential device:	Bevel gear type (both for front and rear wheels)	Bevel gear type (only for rear wheels)	Bevel gear type (both for front and rear wheels)	Bevel gear type (only for rear wheels)	Bevel gear type (both for front and rear wheels)	

■ Travelling Speed

Gear shift	Travelling speed						Uses
	mph			km/h			
	B5100D B5100E	B6100D B6100E	B7100D	B5100D B5100E	B6100D B6100E	B7100D	
1st	0.58	0.65	0.62	0.94	1.04	1.00	Rotary tilling, levelling, ridging
2nd	0.99	1.10	1.06	1.60	1.77	1.71	Rotary tilling levelling
3rd	1.62	1.88	1.82	2.62	3.02	2.93	Rotary furrowing, puddling
4th	2.84	2.95	2.85	4.58	4.74	4.59	Puddling, plowing
5th	4.87	5.02	4.86	7.85	8.08	7.83	Plowing
6th	7.98	8.59	8.32	12.84	13.82	13.39	Trailing work, road travelling
R1	0.81	0.94	0.91	1.31	1.52	1.47	
R2	4.00	4.32	4.18	6.43	6.95	6.73	

★ The Kubota B5100D, B6100D, B7100D is shipped with a choice of the following accessory assortments:

- (1) B5100D
 - (2) B6100D
 - (3) B7100D
 - (4) B5100D-P
 - (5) B6100D-P
 - (6) B7100D-P
- } Tractor
- } Tractor and 3-point hitch

★ The Kubota B5100E, B6100E is shipped with a choice of the following accessory assortments:

- (1) B5100E
 - (2) B6100E
 - (3) B5100E-P
 - (4) B6100E-P
- } Tractor
- } Tractor and 3-point hitch

CONTENTS

1. REQUESTING FOR DEALER'S SERVICES	1
2. THE SUPERIOR LIMIT OF IMPLEMENT	2
3. MAJOR PARTS IDENTIFICATION	4
4. INSTRUMENT PANEL AND CONTROLS	5
4. 1 Switches	5
4. 2 Controls	6
5. OPERATING INSTRUCTIONS	11
5. 1 Pre-start checks	11
5. 2 Operating the engine	11
5. 3 Operating the tractor	12
5. 4 Check during driving	12
5. 5 Directions for operating differential lock pedal	13
6. MAINTENANCE	14
6. 1 Daily check	14
6. 2 Periodic checks	15
7. CHECK AND MAINTENANCE	16
7. 1 Fuel	16
7. 2 Engine oil	18
7. 3 Transmission oil	19
7. 4 Changing front differential case oil (B5100D/B6100D/B7100D)	20
7. 5 Changing front wheel gear case oil (Right and left)(B5100D/B6100D/B7100D)	20
7. 6 Oiling and greasing points before starting	21
7. 7 Radiator	22
7. 8 Tire pressure	24
7. 9 Air cleaner	24
7.10 Battery	25
8. ADJUSTMENTS	26
8. 1 Fan drive belt tension	26
8. 2 Clutch	26
8. 3 Brake	26
8. 4 Steering wheel	27
8. 5 Implement lowering speed	27
8. 6 Implement lifting and lowering limits	27
8. 7 Rear wheel tread	28
8. 8 Toe-in	28
8. 9 Center pin	28
8.10 Exhaust pipe with muffler	28
9. TROUBLESHOOTING	29
9. 1 Battery troubleshooting	29
9. 2 Engine troubleshooting	30
10. LONG-TERM STORAGE	31
11. THREE-POINT HITCH	31
11.1 Three-point hitch adjustment	32
12. OPTIONS	33
13. WIRING DIAGRAM	34

1. Requesting For Dealers Service

Your dealer is interested in your new tractor and has the desire to help you get the most value from it. After reading this manual thoroughly, you will find that you can do many of the regular service jobs quickly and easily.

However, when in need of parts or major service, be sure to see your KUBOTA dealer.

When in need of parts, be prepared to give your dealer both the tractor and engine serial numbers.

The tractor serial number is located on the clutch housing case, left side. The engine serial number is located on the engine crankcase, right side.

Locate the serial numbers now and record them in the space provided.

KUBOTA B5100D/B5100E/B6100D/B6100E/B7100D
TRACTOR

Tractor Serial No. B6001-24682
Engine Serial No. 1006 K2-C-750 650
Date of Purchase

(To be filled in by purchaser)



2. The Superior Limit of Implement

The Kubota tractor has been thoroughly tested for proper performance with implements sold or approved by us. Use with implements which exceed the maximum specifications listed below, or which are otherwise unfit for use with the Kubota tractor may result in malfunctions or failures of the

tractor, damage to other property and injury to the operator or others. [Any malfunctions or failures of the tractor resulting from use with improper implements are not covered by the warranty.]

Model		B5100	B6100	B7100
Operating condition		General control operation (Flat ground and slope condition)		
Lower link end max. loading weight W_0		Below 140 kg (300 lbs.)	Below 180 kg (400 lbs.)	
Actual figures	Implement weight W_1	As in the following list		
	Trailer loading weight W_2	Below 360 kg (800 lbs.) (without brake) Below 720 kg (1600 lbs.) (with brake)	Below 500 kg (1100 lbs.) (without brake) Below 1000 kg (2200 lbs.) (with brake)	

Lower link end max. loading weight The max. allowable load which can be put on the lower link end: W_0
 Implement weight The implement's weight which can be put on the lower link: W_1
 Trailer loading weight The max. loading weight for trailer (without trailer's weight): W_2

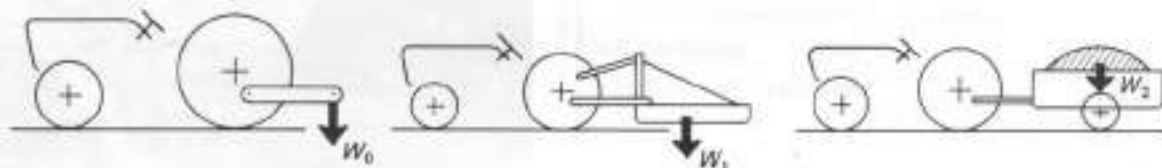

Implement		Remarks	B5100	B6100	B7100
Rotary mower	Rear (1 Blade)	Max. cutting width Max. weight	/	1070mm (42 in.) 140 kg (300 lbs.)	1070mm (42 in.) 140 kg (300 lbs.)
	Rear Mid (2-3 Blade)	Max. cutting width Max. cutting width Max. weight	1120mm (44 in.) 1120mm (44 in.) 110 kg (250 lbs.)	1220mm (48 in.) 1220mm (48 in.) 140 kg (300 lbs.)	1220mm (48 in.) 1520mm (60 in.) 140 kg (300 lbs.)
	Sickle bar	Max. cutting width	1220mm (48 in.)	1220mm (48 in.)	1220mm (48 in.)
Rotary tiller		Max. tilling width Max. weight	910mm (36 in.) 140 kg (300 lbs.)	1070mm (42 in.) 170 kg (380 lbs.)	1070mm (42 in.) 180 kg (400 lbs.)
Bottom plow		Max. size	250mm (10 in.) x 1	300mm (12 in.) x 1	360mm (14 in.) x 1
Disc plow		Max. size	510mm (20 in.) x 1	560mm (22 in.) x 1	560mm (22 in.) x 1
Cultivator		Max. size	1070mm (42 in.) (1 row)	1220mm (48 in.) (1 row)	1220mm (48 in.) (1 row)
Disc harrow		Max. harrowing width Max. weight	1070mm (42 in.) 90 kg (200 lbs.)	1220mm (48 in.) 90 kg (200 lbs.)	1370mm (54 in.) 140 kg (300 lbs.)
Sprayer		Max. tank capacity	93 ℓ (25 gals.)	100 ℓ (30 gals.)	110 ℓ (30 gals.)
Front blade		Max. cutting width Sub frame Oil pressure, relief valve	1070mm (42 in.) Necessary 11.4 MPa (116 kgf/cm ² , 1650 psi)	1220mm (48 in.) Necessary 11.4 MPa (116 kgf/cm ² , 1650 psi)	1220mm (48 in.) Necessary 11.4 MPa (116 kgf/cm ² , 1650 psi)
Rear blade		Max. cutting width Max. weight	1220mm (48 in.) 90 kg (200 lbs.)	1520mm (60 in.) 140 kg (300 lbs.)	1520mm (60 in.) 160 kg (350 lbs.)
Front loader		Max. lifting capacity Max. width Sub frame	160 kg (350 lbs.) 970mm (38 in.) Necessary	227 kg (500 lbs.) 1070mm (42 in.) Necessary	227 kg (500 lbs.) 1070mm (42 in.) Necessary
Box blade		Max. cutting width Max. weight	1070mm (42 in.) 90 kg (200 lbs.)	1070mm (42 in.) 170 kg (380 lbs.)	1070mm (42 in.) 170 kg (380 lbs.)
Backhoe		Max. digging depth Max. weight Sub frame	/	1830mm (72 in.) 270 kg (600 lbs.) Necessary	1830mm (72 in.) 270 kg (600 lbs.) Necessary
Snow blower		Max. working width Max. weight Sub frame	1070mm (42 in.) 140 kg (300 lbs.) Necessary	1070mm (42 in.) 160 kg (350 lbs.) Necessary	1220mm (48 in.) 160 kg (350 lbs.) Necessary
Trailer		Max. load capacity	360 kg (800 lbs.)	500 kg (1100 lbs.)	500 kg (1100 lbs.)
Three point lift		Max. load capacity	140 kg (300 lbs.)	140 kg (300 lbs.)	180 kg (400 lbs.)

3. Major Parts Identification

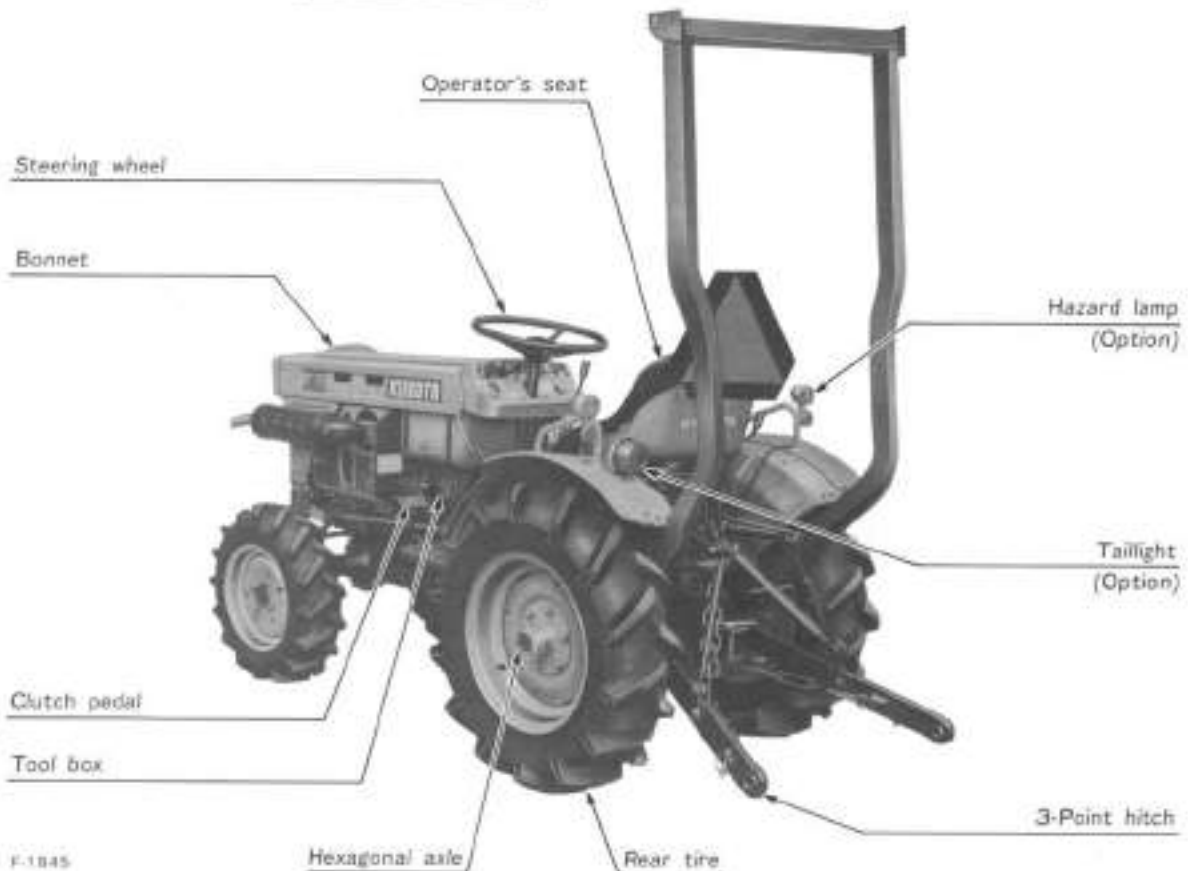
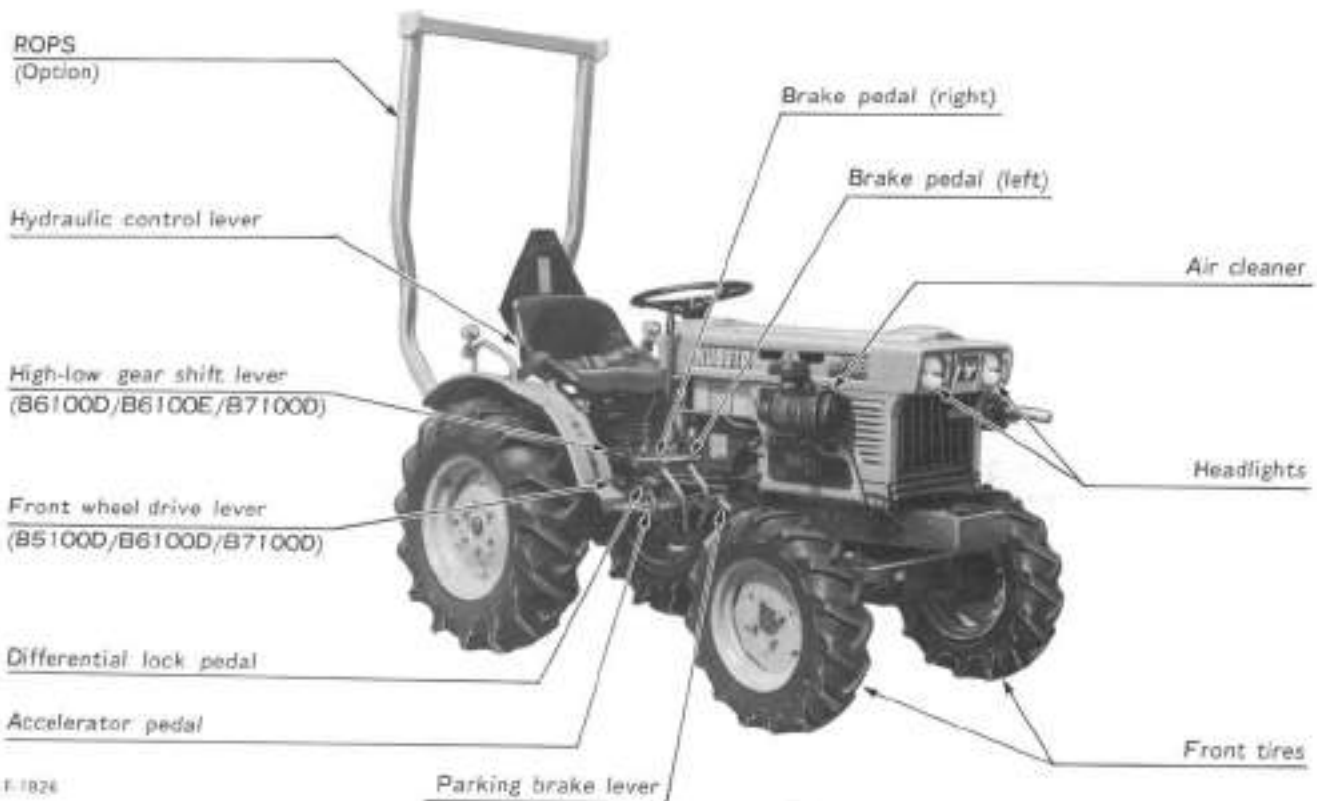

4. Instrument Panel And Controls

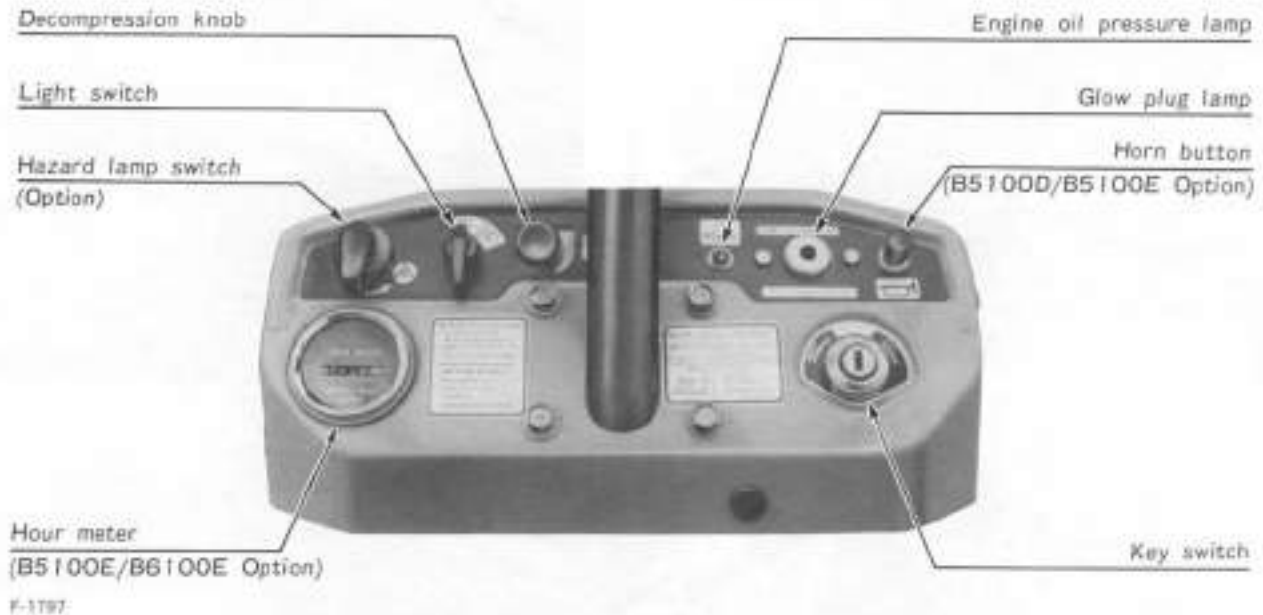

4.1 SWITCHES

■ Key Switch

Inserting the key and turning it one click to the right closes the electrical circuit and lights up the engine oil pressure lamp (RED). Depress the clutch pedal and disengage the clutch. Next, turning the key left activates the glow plug (preheating coil), proceeding to preheat the combustion chamber. After ascertaining that the glow plug lamp has turned red and that the engine has been preheated completely, turn the key switch right and the cell starter will start to rotate and the engine will then start. Release the key switch and it will return to the home position ☉

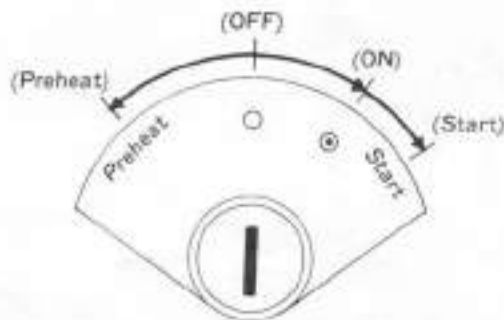

■ Glow Plug Lamp

Turn the key switch left and the glow plug lamp will start turning red, indicating that the engine is preheating.

■ Hour Meter (B5100E/B6100E : Option)

As the hour meter works electrically, it starts to work when the key switch is turned to ON or PREHEAT.

■ Horn Button (B5100D/B5100E : Option)

Turning the key switch one click to the right then pressing the horn button (RED) sounds the horn.

■ Light Switch

Turning the light switch one click to the right illuminates the headlights and taillight (Option).

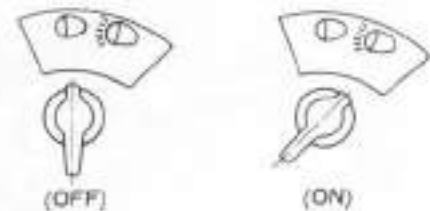

■ Hazard Lamp Switch (Option)

When the hazard lamp switch is turned counterclockwise, the Hazard Lamp blinks.

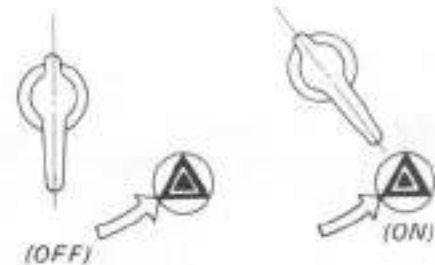

■ Engine Oil Pressure Lamp (RED)

The oil pressure lamp will glow red when the starter switch is turned on. This indicates the light and electrical wiring are okay. The light should go out after engine starts. If light remains on, stop engine and determine cause.

■ Decompression Knob

To assist in cold weather starting, or starting with a weak battery, the following procedures should be used:

- Set throttle to proper start position,
- Pull out the decompression knob,
- Engage starter and allow engine RPM to build up,
- While cranking engine, push decompression knob back in to allow engine to start.

■ Fuses

Opening the bonnet reveals the 5-ampere and 3-ampere fuses (on the rear of the instrument panel) which safeguards the electrical circuit. When the fuse (s) is blown, examine the cause of the overcurrent, eliminate the trouble and replace with a new fuse. After that, ensure normal amperage. (Spare fuses are provided with new tractor.)

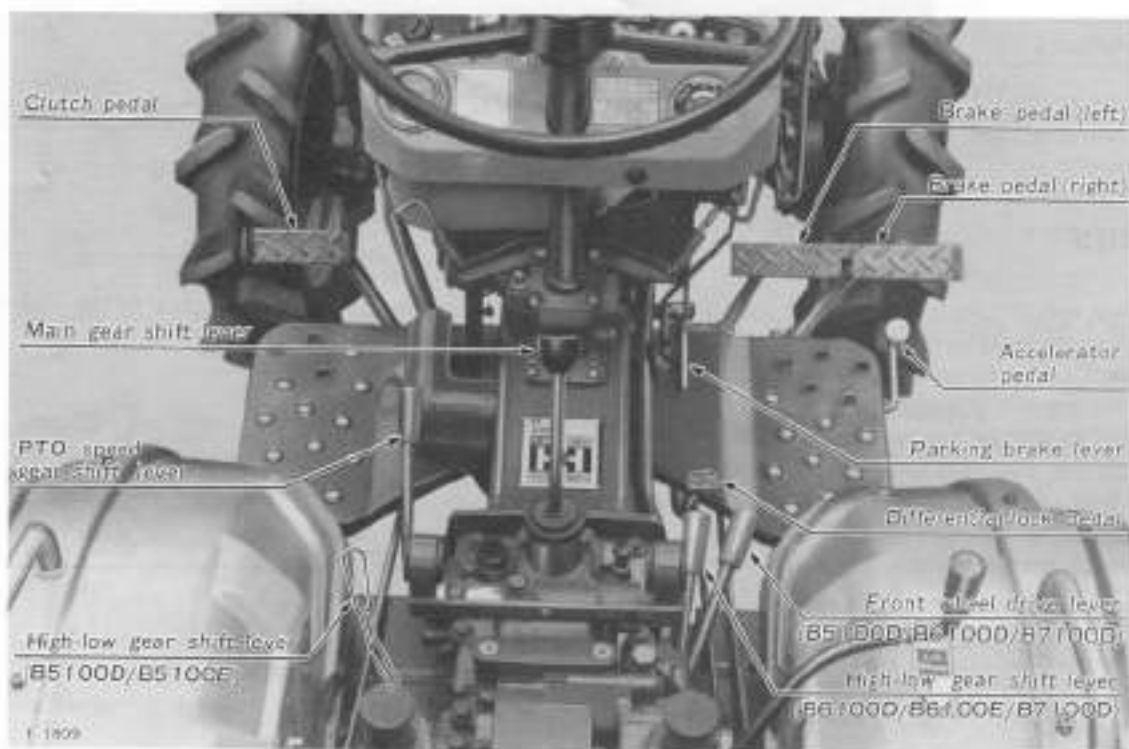

4.2 CONTROLS

■ Accelerator Lever and Pedal

Moving the accelerator lever backward slows down the engine and moving it forward speeds up the engine. In addition, the engine is speeded up by stepping on the accelerator pedal with the accelerator lever left in the backward position. To stop the engine, pull the engine stop lever (release arm).

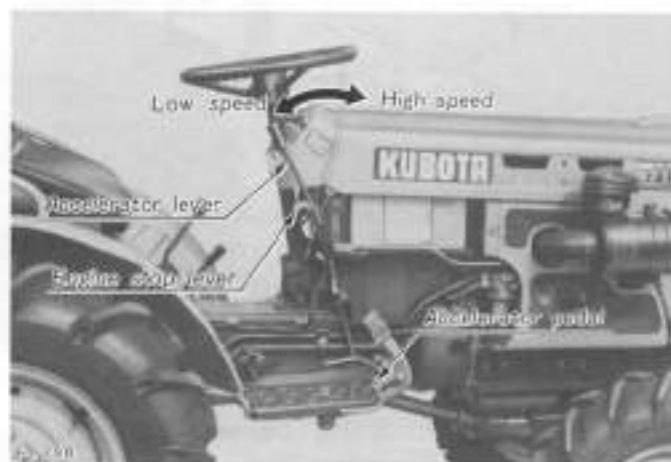

Hydraulic Control Lever

Operating the hydraulic control lever actuates the hydraulic lift arm, which controls the elevation of the tractor implement. Moving the lever forward lowers the implement and moving it backward raises the implement. When the implement reaches the upper or lower limit, the lever automatically returns to the neutral position. In addition, when the lever is brought to the neutral position while the implement is moving up or down, the implement stops and remains at that level.

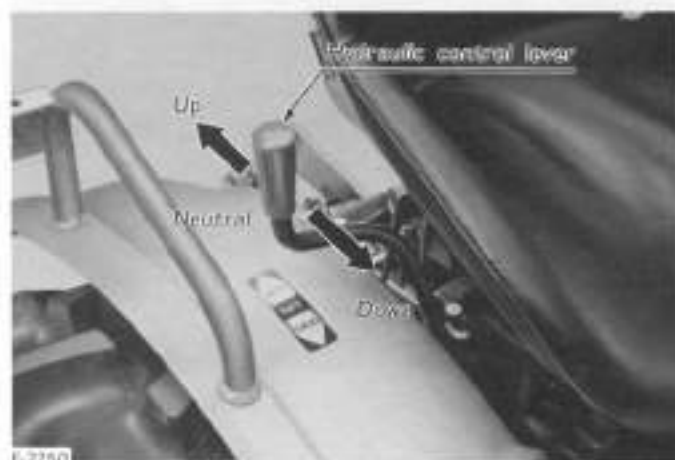

Main Gear Shift Lever and High-Low Gear Shift Lever

The main gear shift lever positions are of H-configuration and the high-low gear shift lever positions of I-configuration. Combined operation of both speed control lever makes possible 6 forward speed changes and 2 reverse speed changes. Specifically, 3 forward speeds and one reverse speed are achieved with the high-low gear shift lever set at LOW while 4th to 6th forward speed and 2nd reverse speed are achieved with the high-low gear shift lever set at HIGH.

B6100D/B6100E/B7100D



B5100D/B5100E

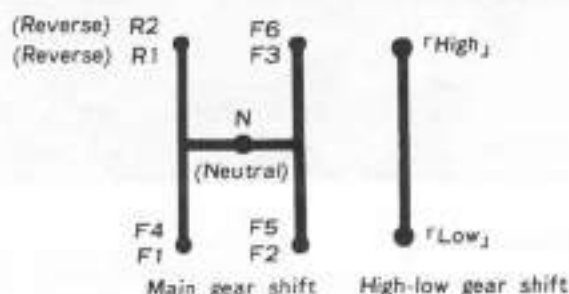

PTO Speed Gear Shift Lever

PTO shaft speed is controlled in 3 steps (B6100D/B6100E/B7100D), 2 steps (B5100D/B5100E). To change PTO shaft speed, be sure to step on the clutch pedal to disengage the clutch.

CAUTIONS:

- When using a rotary tiller, use only 1st gear for rotating in extremely hard or rocky field. Otherwise, troubles may occur. Also this would ensure smooth operation and maximum possible depth.
- Never use PTO 2nd or 3rd gear except following the instruction of the implements.
When necessary PTO to use PTO 2nd or 3rd gear, adjust the restricting plate as follows. (B6100D/B6100E/B7100D).
 - When use 2nd gear, loosen the bolt and slide the plate forward.
 - When use 3rd gear, take off the plate.



■ Front Wheel Drive Lever (B5100D/B6100D/B7100D)

The front wheel drive lever is used in the event that greater traction power is required on a slope or a wet field or that the tractor must be prevented from lunging during rotary-tilling hard soil.

Lowering the lever drives the front wheels—4 wheel drive.



■ Clutch Pedal

Fully stepping on the pedal disengages the clutch off the power transmission.



CAUTION:

- (1) The clutch pedal must be quickly disengaged and be slowly engaged.
- (2) Never run the machine with your foot placed on the clutch pedal.

■ Brake Pedals (Right and Left)

- (1) When operating the tractor on a road, be sure to interlock the right and left pedals as illustrated below. It will be very dangerous to use only one brake.
- (2) Use individual brakes to assist in making sharp turns. Disengage the brake lock and depress only one brake pedal.



■ Parking Brake Lever

When getting off the tractor for parking or checking, be sure to interlock the right and left brake pedals.

This procedure locks the parking brake latch on the slots of brake pedal, applying the parking brake.

To release the parking brake, step on the brake pedal again.



■ Differential Lock Pedal

Differential lock is applied in cases where: the wheels are likely to slip, only one of the rear wheel slips, or the tractor climbs a slope or runs over the field rows.

Lightly stepping on the differential lock pedal with the heel makes the rear wheels run at equal speed. To unlock, just release the pedal.



■ Seat

The seat can be adjusted to three pre-set positions to the operator's convenience. The adjustment is effected by lifting the front of the seat and resetting the lock pin from one to another hole.

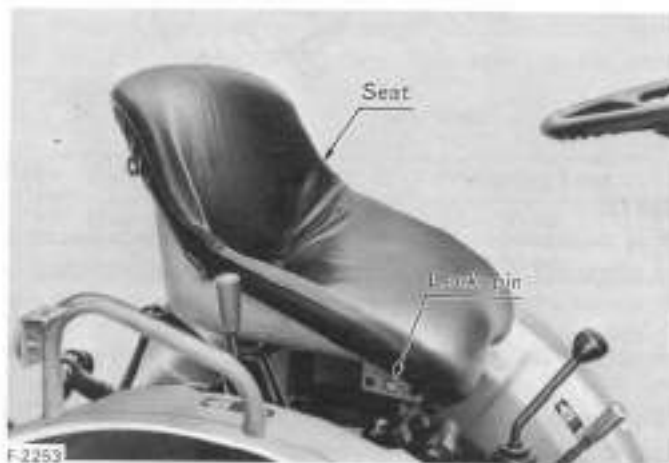

■ Implement Lock Chain (B5100D/B5100E : Option)

When transporting on the road or checking the implement in the raised position, be sure to hook one end of the implement lock chain on the chain bracket as shown in the picture so as to prevent the implement from dropping.

When the chain is not being used, remove it from the bracket, and fasten it to the hook.

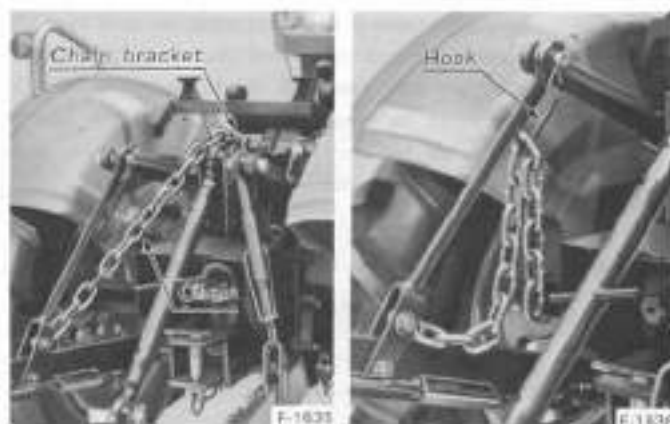

■ How to Open the Bonnet



SAFETY PRECAUTION:

- Never open the bonnet while the engine is running.

To open the bonnet, take off the bonnet latch on the right and left sides.



Directional Control Valve

(B5100D/B6100D/B6100E/B7100D)



[CAUTION]

- Escaping hydraulic fluid under pressure can have sufficient force to penetrate skin, causing serious personal injury. Before disconnecting lines, be sure to relieve all pressure. Before applying pressure to the system, be sure that all connections are tight and that lines, pipes and hoses are not damaged. Fluid escaping from a very small hole can be almost invisible. Don't use hands to search for suspected leaks, but use a piece of cardboard or wood.

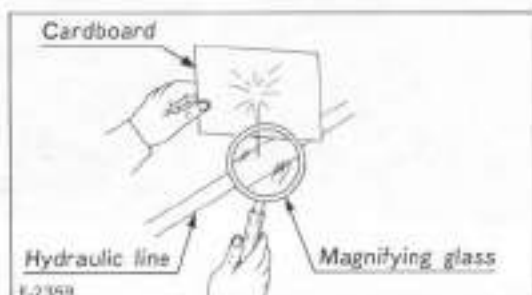

If injured by escaping fluid, see a doctor at once. Serious infection or reaction may result if proper medical treatment is not administered immediately.

When a hydraulically operated implement is connected to the tractor, oil flow can be switched to the control valve on the implement by means of the grip on the directional control valve assembly.

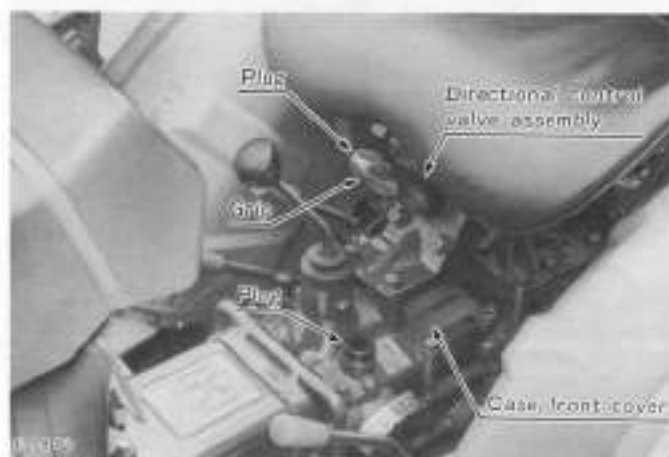

- With the arrow on the grip in the position shown in the figure, oil flows into the cylinder in the tractor.

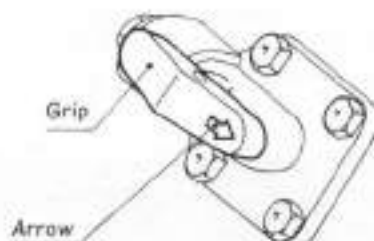

- To permit oil to flow into the control valve on the implement:

- Remove the plug from the directional control valve assembly and connect the hose from the implement to the assembly (screw : PS $\frac{1}{2}$).
- Remove the plug from the case front cover, and connect the return hose from the implement to the cover (screw : PF $\frac{1}{2}$).
- Move the control lever on the tractor backwards, and turn the grip on the directional control valve assembly by 180°. Oil will then flow into the control valve on the implement.

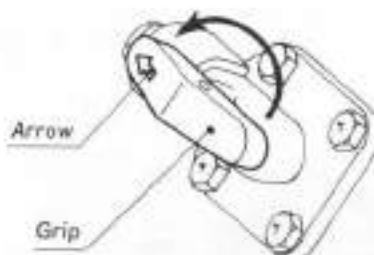

NOTE:

- If an implement (e.g. rotary tiller) or a balance weight is connected to the rear of the tractor, lower the implement or weight a little so that the control lever can be operated with ease.

5. Operating Instructions

5.1 PRE-START CHECKS

Prior to starting the engine, make pre-start checks according to the Service Schedule on page 14.

5.2 OPERATING THE ENGINE



SAFETY PRECAUTION:

- (1) Do not start the engine in a closed room. Otherwise, the air will be polluted with exhaust gas and this is very dangerous.
- (2) Make it a rule to set the main gear shift lever and PTO speed gear shift lever to the "neutral" positions when starting the engine.

■ Starting

- (1) Sit down on the operator's seat.
- (2) Step on the parking brake.
- (3) Place the main gear shift lever and the PTO speed gear shift lever to the neutral position.
- (4) Set the accelerator lever to the high position.
- (5) Plug the key into the key switch and turn it on.
- (6) Make sure that the engine oil pressure lamp has lit up.
- (7) Fully step on the clutch pedal and turn the key switch left, waiting for the glow plug lamp to turn red.

Though the glow plug lamp turns red in about 10 seconds, it takes at least 20 seconds until the preheating coil in the combustion chamber is fully heated. The lower the ambient temperature, the longer the preheating time. For the necessary preheating time, refer to the table below:

Temperature	Preheating Time
Over 0°C (32°F)	20 – 30 sec.
0 to -5°C (32 to 23°F)	20 – 60 sec.

- (8) Turn the key switch to the start position and the starter will run and the engine will then start.
- (9) Make sure that the engine oil pressure lamp has gone off. If the lamp is still on, immediately stop the engine and check the lubrication system (See page 18).
- (10) Perform warm-up operations by running the engine at the medium speed.

CAUTION:

- (1) While the engine is running, do not turn the key switch.
- (2) If the engine does not catch motion 10 seconds after the key switch is turned on, wait about 20 seconds more and repeat the procedure above. If the key switch is continuously set to the Start position for more than 30 seconds, it may lead to the trouble with the starter.

- (3) Be sure to perform warm-up operations regardless of the ambient temperature. If the tractor is run before the engine warms up, the engine life is reduced, and the tractor life, in turn, will also be affected.
- (4) Don't use starting fluid to prevent the serious trouble of engine.

■ Starting with Dull Battery or in Cold Weather

Perform the following procedure between the steps (6) and (9) on Starting:

- (1) Pull out the decompression knob.
- (2) Depress the clutch pedal all the way and turn the key switch to the start position.
- (3) After the flywheel starts to run at full pitch in 3 to 5 seconds, push the decompression knob back. If necessary, operate preheating before drawing the decompression knob.

CAUTION:

When the ambient temperature is less than -15°C (5°F), remove the battery from the tractor and store it somewhere warm until next operation.

■ Stopping

- (1) Slow down the engine to less than 16.7 r/s (1000 rpm) by moving the accelerator lever backward and releasing the accelerator pedal.
- (2) Fully raise the stop lever and the engine will stop.
- (3) Turn the key switch off and draw the key out.

CAUTION:

Although engine can be stopped by drawing the decompression knob, this should never be done except in such an emergency case that the engine cannot be stopped by pulling the engine stop lever. Especially, if the decompression knob is drawn while the engine is running at high speed, there is the danger that the valve seat may bite dust or that the decompression device may develop troubles. For this reason, be absolutely sure not to draw the decompression knob when the engine is running except in emergency cases.

5.3 OPERATING THE TRACTOR

■ Starting

- (1) Depress the clutch pedal and disengage the clutch.
- (2) Shift the main and high-low gear shift levers to the desired speed positions.
- (3) Unlock the parking brake.
- (4) Speed up the engine by moving the accelerator lever forward or by stepping on the accelerator pedal.
- (5) Slowly release the clutch pedal and the tractor will move.



SAFETY PRECAUTIONS:

- (1) Sudden release of the clutch pedal makes the tractor dangerously lunge forward.
- (2) Gear shift cannot be accomplished during driving. To do this, be sure to stop the tractor by fully stepping on the clutch pedal.
- (3) Interlock the right and left brake pedals before starting. Uneven braking results in a sharp turn, which may even turn over the tractor.
- (4) Do not allow any person other than the driver to ride on the tractor.
- (5) Do not drive the tractor close to the edges of ditches or banks which may break under the weight of the tractor, especially when the ground is loose or wet.
- (6) When turning the tractor, be sure to slow down the engine and, as necessary, moving the high-low gear shift lever to LOW.
- (7) Do not drive the tractor on the road with the implement in motion.
- (8) After the differentail lock has been used, be sure to see that it has been released.
- (9) When going down a slope, apply the engine brake. Stepping only on the brake pedal is dangerous.
- (10) When traveling on a road, attach the S.M.V. emblem to the tractor to identify itself to be a low speed vehicle (Option).

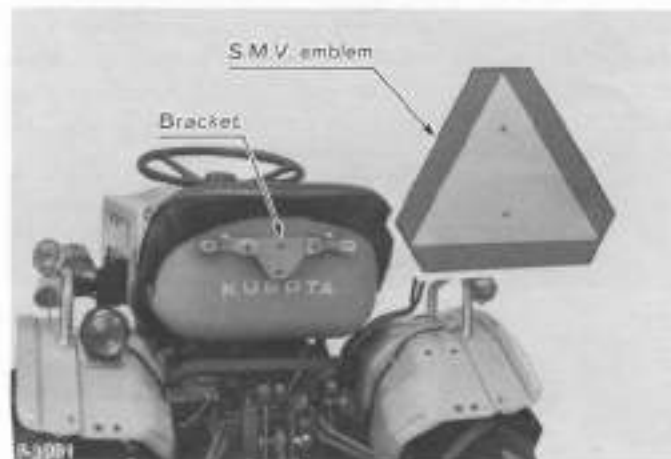

CAUTION:

- (1) Do not start the tractor with the parking brake on. Trouble may occur.
- (2) Do not drive with your foot on the clutch pedal.

■ Stopping

- (1) Slow down the engine.
- (2) Step on both the clutch pedal and brake pedal and the tractors will stop.
- (3) Place the main gear shift lever to the neutral position and release the clutch pedal.
- (4) Interlock the right and left brake pedals then apply the parking brake.

■ Parking



SAFETY PRECAUTIONS:

- (1) When parking, be sure to apply the parking brake.
- (2) When parking on a slope, be sure to place the stones or the like behind the wheels to prevent accidental rolling of the machine.

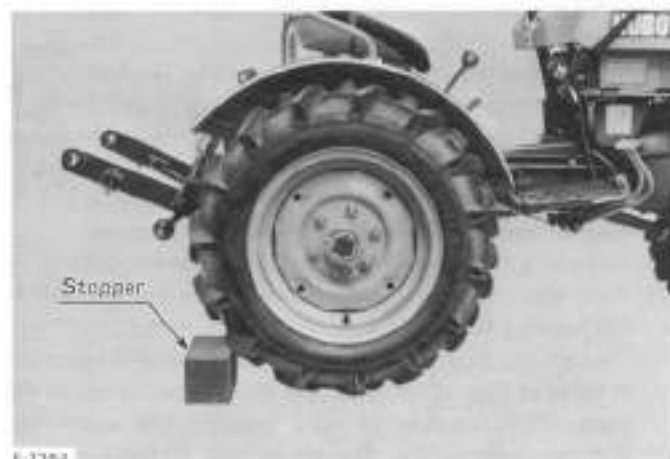

- (3) Before getting off the tractor, be sure to stop the engine and lower the implement to the ground to prevent sudden dashing or implement drop.

5.4 CHECK DURING DRIVING

While driving, make the following checks to see that all the parts are functioning normally.

■ Cooling Water



SAFETY PRECAUTION:

- To remove the radiator cap, wait for about 10 minutes after stopping the engine. Immediate removal of the radiator cap lets the hot water spray out, scalding the operator.

If the temperature of the cooling water rises above 100°C (212°F) and the vapor and water don't stop running out of the overflow pipe, immediately stop the engine and exercise the following checks and remedies, with the safety precautions in mind.

- (1) Shortage or leakage of the cooling water.
- (2) Foreign matter on the radiator net and dust and dirt between the radiator fins and tube.
- (3) Slackness of the fan drive belt.
- (4) Fur formation in the radiator tube.
- (5) Unnecessary addition of anti-freeze to the cooling water not in cold weather.

■ Engine Oil Pressure Lamp

The pressure lamp signals to the operator that the engine oil pressure falls under the prescribed level. If the lamp should go on during driving and off even at more than 16.7 r/s (1000 rpm), immediately stop the engine and check:

- (1) The level of the engine oil (See page 18).
- (2) The conditions of the lubrication system (See page 19).

■ Fuel

Be careful for the fuel tank not to run dry. Otherwise air may be sucked into the fuel system. Should this happen, the system must be bled. (See page 16).

■ Exhaust Fumes

- (1) Exhaust fumes are colorless at normal output drive.
- (2) Exhaust fumes become a little colored when output power develops above the rating, but does not affect the traction. If the exhaust turns dark continuously during driving, this probably indicates an overburden on the engine. In such a case, corrective action should be applied to conditions of operation so that subsequent damage to the engine can be avoided.

■ Urgent Stop

Should the following abnormally take place, immediately stop the engine.

- (1) The engine suddenly slows down or speeds up.
- (2) Unusual noises are suddenly heard.
- (3) Exhaust fumes suddenly become very dark.
- (4) The engine oil pilot lamp goes on during driving.

For checks and remedies in the above situations, consult your dealer for instruction.

5.5 DIRECTIONS FOR OPERATING DIFFERENTIAL LOCK PEDAL

The proper use of the differential lock enhances your tractor performance to a great extent while its wrong use may subject the operator to serious dangers or lead to tractor troubles. Thus be sure to observe the following precautions when applying the differential lock.

- (1) Do not apply the differential lock immoderately and instead limit its use to the below situations. Note, however, that the differential lock may sometimes be not engaged when the right and left rear wheels are running at the same speed.
 - When the tractor enters or leaves the farm field, it cannot run straight because of excessive individual wheel-spin under difficult or slippery field conditions.
 - One rear wheel is caught in a loose area of the field and the tractor cannot run due to wheel-spin.
 - In the case of plowing, the rear wheel closer to the ridge is caught in the loose soil and is affected by wheel-spin.
- (2) The use of the differential lock must be limited to a particular period of time and cannot be applied beyond that limit.
- (3) When the rear wheel is subjected to excessive loads, even releasing the pedal sometimes may not unlock the differential although the pedal springs back. Should the differential not unlock when turning the tractor, lightly step on the brake pedal opposite to the turn side or else turn back the steering wheel and run the tractor straight. By doing so, the differential can be unlocked. If the brake pedal of the turn side is depressed during turning, the differential lock system takes on an undue load. Be careful about such a improper operation. The tractor cannot turn with the differential locked and attempting this is very dangerous. Take utmost care not to do this.

6. Maintenance

6.1 DAILY CHECK

To prevent trouble from occurring, it is important to know the conditions of the tractor well. Check it before starting.



SAFETY PRECAUTION:

Be sure to check and service the tractor on a flat place with the engine shut off and the parking brake on.

- 1) Check the parts where there was trouble before.
- 2) Walking around the tractor:
 - (1) Check the tire pressure, and check for wear and damage. (See page 24)
 - (2) Check for oil and water leaks. (See page 18 to 20, 22 to 24)
 - (3) Check the engine oil level and check for contamination. (See page 18)
 - (4) Check the amount of transmission oil and whether it is contaminated. (See page 19)
 - (5) Check if there is enough fuel. (See page 16)
 - (6) Check if there is enough cooling water in the radiator. (See page 22)

- (7) Check for dust load on the air cleaner dust cup. (See page 25)
 - (8) Check the tractor body for damage and check that all bolts and nuts are tight.
 - (9) Check the pilot lamps for failure.
 - (10) Check the S.M.V. emblem plate for stains and damage.
- 3) While sitting on the driver's seat:
 - (11) Check the brake and clutch pedals. (See page 26 to 27)
 - (12) Check the parking brake. (See page 27)
 - (13) Check the steering wheel. (See page 27)
 - 4) Turning the key switch on:
 - (14) Check the performance of the pilot lamp and check for any stains.
 - (15) Check the electric horn, headlights, taillight, and hazard lamps.
 - 5) Starting the engine:
 - (16) Check the color of the exhaust fumes.

6.2 PERIODIC CHECKS

Frequency of Checks	Check Points	Reference Pages
Initial operation (initial 60 hours)	During this period, pay special attention to the following. (1) After the initial 35 hours of use, change the engine oil and clean the oil filter. (2) After the initial 50 hours of use, change the transmission oil and the oil filter. (3) Sudden starting or braking should be avoided.	—
Every 50 hours	Check chasis greasing or oiling: King pin, rod end, center pin, interlock rod, pedal shaft, front wheel drive lever.	21 to 22
Every 75 hours	Change engine oil.	18
Every 100 hours	Clean air cleaner element.	24
	Clean fuel filter.	17
	Check nozzle piece and change it when horsepower drops abnormally.	—
	Check fuel pipe.	17
	Check fan drive belt tension.	26
	Check clutch play.	26
	Check brake play.	26 to 27
	Check steering wheel play.	27
Every 150 hours	Change engine oil filter cartridge.	19
	Check radiator hose.	23
Every 300 hours	Change transmission oil; Transmission case, front differential case (4WD), front wheel gear case (right and left) (4WD), steering case	19 to 20
Every 500 hours	Clean radiator interior.	23
Every one to two months	Top up battery.	25
Every 3 months	Change inhibitor and cooling water.	22 to 24
Every year or every 6 times of cleaning	Change air cleaner element.	25
Every year	Change anti-freeze and cooling water.	22, 24
Every 2 years	Change battery.	25
	Change radiator hose and tightener band.	23
	Change fuel pipe and tightener band.	17

7. Check And Maintenance

7.1 FUEL

■ Checking and Refueling



SAFETY PRECAUTION:

- Stop the engine before adding fuel. Keep away from sparks and flames.

- (1) Check the fuel level. Take care that the fuel level does not fall under the prescribed lower limit.

Fuel tank capacity

B6100D/B6100E/B7100D	13ℓ (3.4 gals.)
B5100D/B5100E	8ℓ (2.1 gals.)

- (2) Use high speed diesel fuel or No. 2 diesel fuel.
- (3) Use No. 1 diesel fuel, if temperature is below -10°C (15°F).



CAUTION:

- (1) Always use a strainer in refueling, or the mingled dust and sand may impair the fuel injection pump.
- (2) Once the fuel tank becomes empty air is admitted to the fuel system, in such case, starting cannot be effected without bleeding.

■ Bleeding the fuel tank

Air must be removed:

- (1) when the fuel filter and piping are removed.
- (2) when fuel is used up.
- (3) after the tractor has not been used for a long period of time.

Bleeding procedure is as follows:



SAFETY PRECAUTION:

- Do not perform bleeding when the engine is hot.

- (1) Fill the fuel tank with fuel, and open the fuel cock.

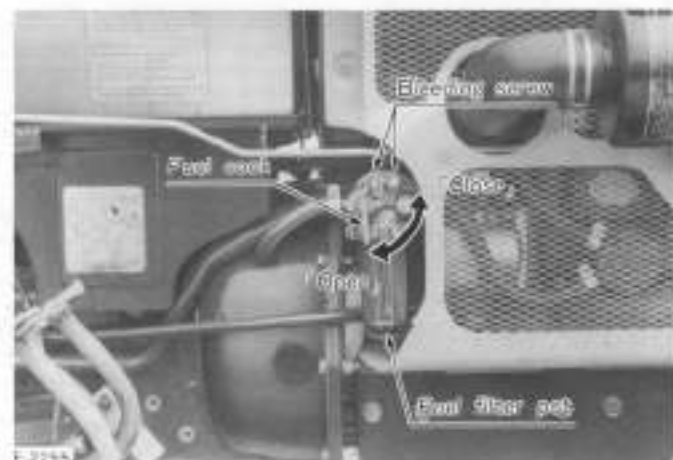

- (2) Twist off the bleeding screws at the top of the filter with two turns.
- (3) When bubbles disappear from fuel coming out of the plug, twist it back on.



- (4) Open the air vent plug on the fuel injection pump.
- (5) Pull the engine stop lever to stop the engine, and start the cell starter for about 10 seconds.

Need small O ring on filter
Air vent plug



SAFETY PRECAUTION:

- Be sure to pull the throttle lever completely before starting the cell starter.

(6) Close the air vent plug when air bubbles disappear from the fuel flowing out.

■ **Checking Fuel Pipe**



SAFETY PRECAUTION:

- (1) Stop the engine when attempting the check and change prescribed below.
- (2) Never fail to check the fuel pipe periodically. If the fuel pipe is subject to wear and aging, fuel may leak out onto the running engine, causing a fire.

Although checking the fuel pipe connections is recommended every 100 service hours, it should be done every 6 months if operation does not exceed 100 hours in 6 months.

(1) If the tightener band is loose, apply a slight coat of lubricant onto the threads and securely retighten it.

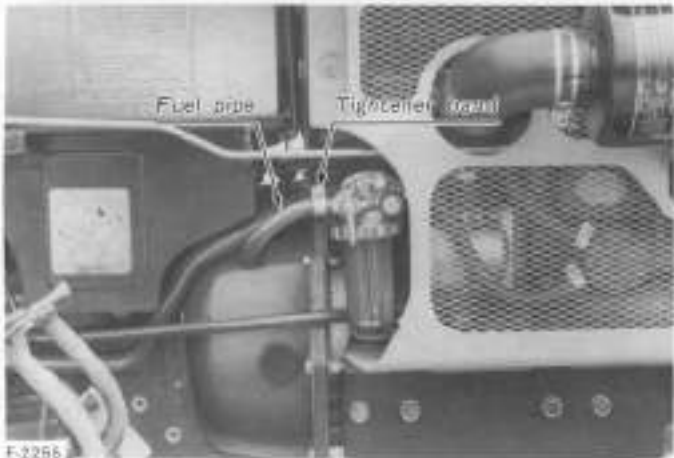

- (2) The fuel pipe is made of rubber and ages regardless of period of service. Change the fuel pipe together with the tightener band every two years and securely tighten.
- (3) If the fuel pipe and tightener band are found damaged or degraded earlier than two years, then change or remedy.
- (4) After the fuel pipe and tightener band have been changed, bleed the fuel system.

CAUTION:

When the fuel pipe is disconnected for change, close both ends of the fuel pipe with a piece of clean cloth or paper to prevent dust and dirt from entering. Entrance of dust and dirt causes malfunction of the fuel injection pump. In addition, particular care must be taken not to admit dust and dirt into the fuel pump.

■ **Cleaning the Fuel Filter Pot**

When period of operation reaches approx. 100 hours, clean the fuel filter. This job should not be done in the field, but in a clean place so as to prevent dust intrusion.

(1) Close the fuel filter pot cock.

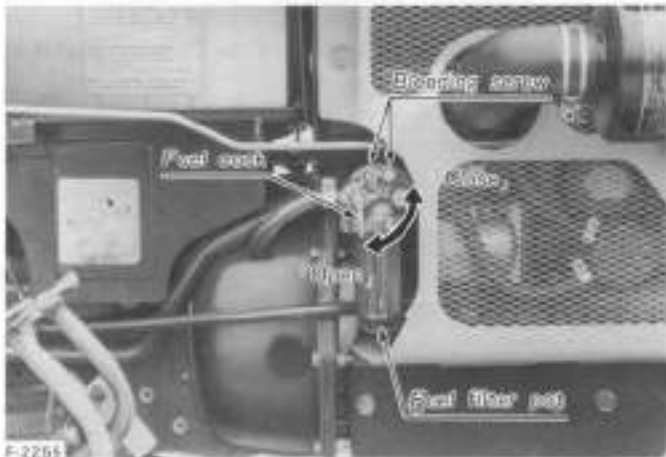

- (2) Unscrew and remove the top cap, and rinse the inside with kerosene.
- (3) Take out the element and dip it in the kerosene to rinse.

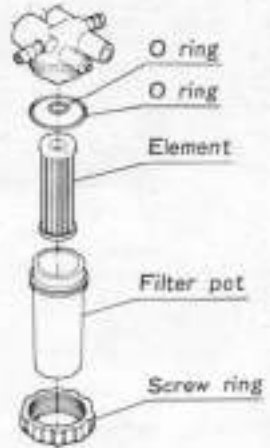

- (4) After cleaning, reassemble the fuel filter, keeping out dust and dirt.
- (5) To bleed the fuel filter, open the fuel cock and loosen the bleeding screws (two) with two or three turns of a wrench. When air bubbles disappear from the fuel flowing out, retighten the bleeding screws.
- (6) Also bleed the injection pump.

CAUTION:

If dust and dirt enter the fuel, the fuel pump and injection nozzle are subject to quick wear. To shut off this, be sure to clean the fuel filter pot periodically.

7.2 ENGINE OIL

■ Oil Level Check and Replenishment

- (1) Check engine oil either before starting the engine or 5 minutes or more after the engine has stopped.
- (2) To check the oil level, draw out the dipstick, wipe it clean, replace it, and draw it out again. Check to see that the oil level lies between the two notches.
- (3) If the level is too low, add new oil to the prescribed level at the oil port.

Use Engine Oil SAE or equivalent.

Capacity

B6100D/B6100E/B7100D	3.9ℓ (4.1 qts.)
B5100D/B5100E	2.3ℓ (2.4 qts.)

B6100D/B6100E/B7100D

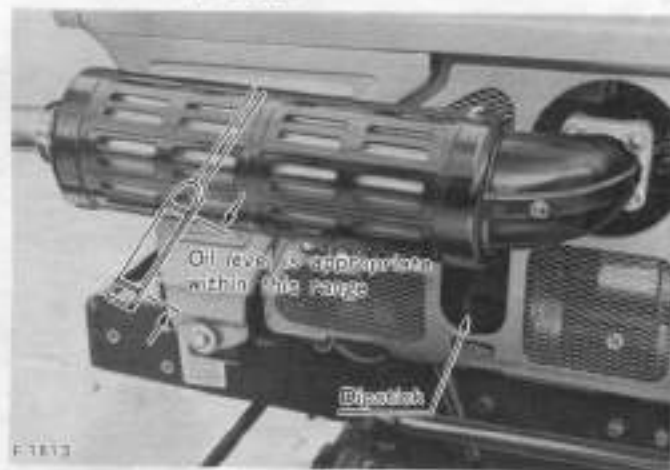

B5100D/B5100E



- (4) When using an oil of different type, make or viscosity from the previous one, remove all of the old oil. Never mix two different types of oil.
- (5) Use the proper Engine Oil SAE according to the ambient temperatures:

Below 0°C (32°F)	SAE10W or 10W-30
0~25°C (32~77°F)	SAE20 or 10W-30
Above 25°C (77°F)	SAE30 or 10W-30

■ Engine Oil Change



SAFETY PRECAUTION:

- Before changing the oil, be sure to stop the engine.

- (1) To change the used oil, remove the drain plug at the bottom of the engine and drain the oil completely. All the used oil can be drained out easily when the engine is still warm.



- (2) Top up with the new oil up to the upper notch on the oil gauge.

KUBOTA OIL FILTER 70000-15241

Oil Filter Cartridge Change



SAFETY PRECAUTION:

- Be sure to stop the engine before changing the oil filter cartridge.

- The oil filter cartridge must be changed every 150 service hours.
- Apply a slight coat of oil onto the cartridge gasket.
- To install the new cartridge, screw it in by hand. Over-tightening may cause deformation of rubber gasket.
- After the new cartridge has been replaced, the engine oil normally decreases a little. Thus see that the engine oil does not leak through the seal and be sure to read the oil level on the gauge. Then, replenish the engine oil up to the prescribed level.



KUBOTA UDT oil is now used for the transmission of this tractor. Whenever replenish or replace, use only multi-purpose oil shown the belows or equivalents.

Maker	Brand
KUBOTA	UDT hydrostatic transmission oil
SHELL	DONAX-TD, DONAX-TM
Mobil	Mobil Fluid 350
Exxon	Torque Fluid 56

Do not mix up the other nature of oil other than above. When it is necessary to use SAE No. 80 gear oil by some reasons, you must drain oil off completely.

Capacity

B5100D/B5100E	8.5ℓ (9.0 qts.)
B6100D/B6100E/B7100D	11.5ℓ (12.2 qts.)

B6100D/B6100E/B7100D



B5100D/B5100E



7.3 TRANSMISSION OIL



SAFETY PRECAUTION:

- Be sure to stop the engine before checking and changing the transmission oil.

Transmission Oil Check and Replenishment

Draw out the dipstick atop the transmission case and wipe off oil. Then, replace it and remove it again to determine the oil level. The appropriate oil level is on the upper notch. If short, replenish through the oil port.

■ Transmission Oil Change

The oil in the transmission case is also used for the hydraulic drive system.

To drain the transmission case, place a oil pan underneath the transmission case and remove the drain plugs at the bottom of the transmission case.

After draining, disassemble and clean the hydraulic oil filter. Then, after reassembling fill with new oil.



F-1809

■ Cleaning Hydraulic Oil Filter (in changing transmission oil)

As the finest dust in the oil could impair the component parts of the hydraulic system precision-built to withstand high pressure, the suction pipe end is fitted with an oil filter. When changing the transmission oil, disassemble and rinse the oil filter with kerosene to completely clean off dust. On reassembly, undertake utmost care not to damage the parts.

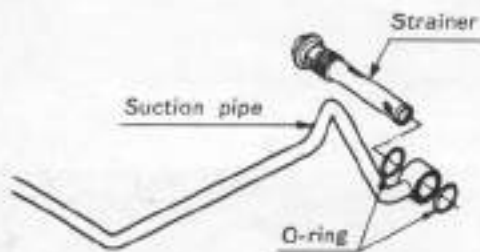

F-2248

7.4 CHANGING FRONT DIFFERENTIAL CASE OIL (B5100D/B6100D/B7100D)

Remove the drain and filling port plugs. After draining, replace the drain plug and fill with new oil.

Type of oil: Gear Oil SAE 80 or equivalent

Quantity of oil:

B5100D/B6100D	0.5ℓ (0.53 qt.)
B7100D	0.7ℓ (0.74 qt.)



F-1806

7.5 CHANGING FRONT WHEEL GEAR CASE OIL (RIGHT AND LEFT) (B5100D/B6100D/B7100D)

Remove the drain and filling port plugs to discharge the used oil. After draining, replace the drain plug and fill with new oil.

Type of oil: Gear Oil SAE 80 or equivalent

Quantity of oil: 0.15 ℓ (0.15 qt.)

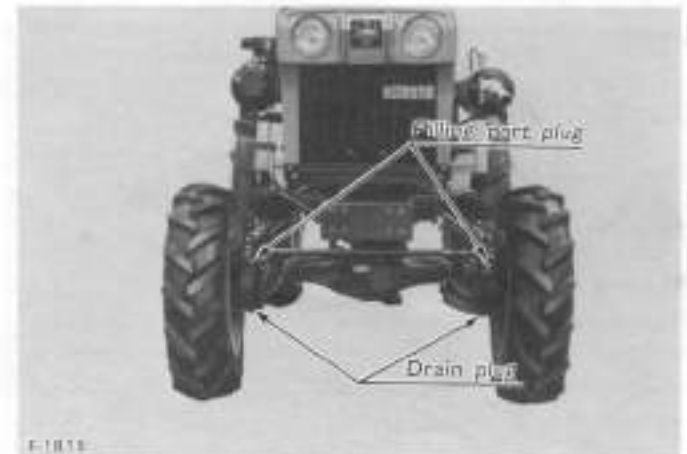

F-1811

7.6 OILING AND GREASING POINTS BEFORE STARTING

Oil or grease the following points before starting.

■ King Pins, Rod Ends and Center Pin

Grease the king pins, rod ends and center pin with the provided grease gun.

B5100D/B6100D/B7100D

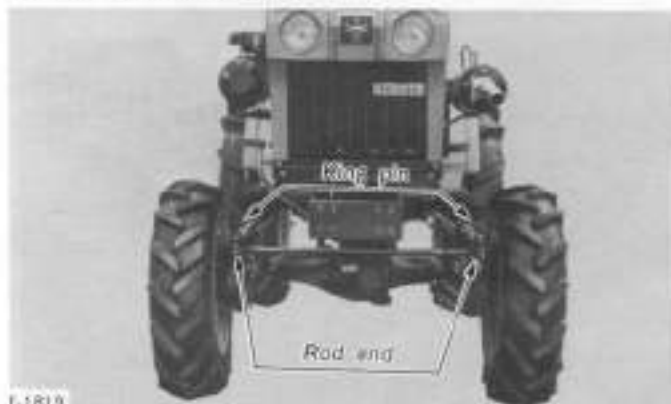

F-1819

B5100E/B6100E

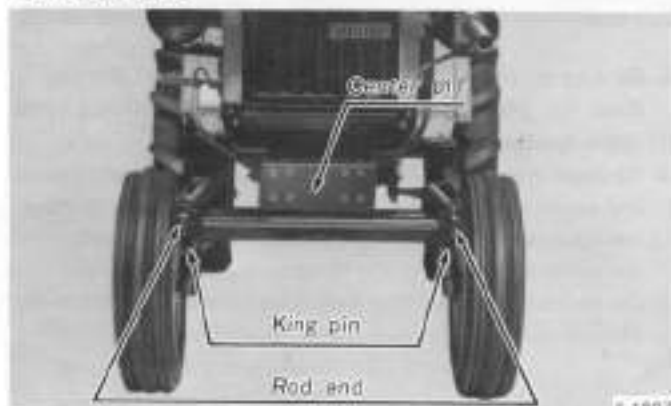

F-1807



F-1820

■ Interlock Rod

Oil or grease the interlock rod and sliding holder.

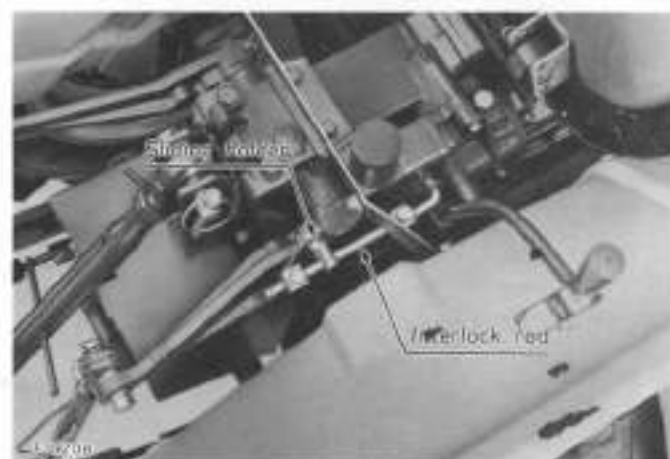

■ Pedal shafts

Grease the grease nipples on both ends of the pedal shaft.

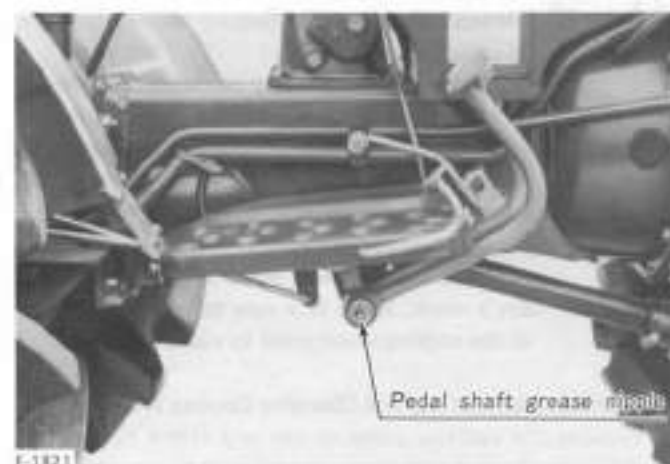

F-1821



F-1822

■ Front Wheel Drive Lever (B5100D/B6100D/B7100D)

Oil the ball race at the root of the front wheel drive lever.



7.7 RADIATOR



SAFETY PRECAUTION:

- (1) Before changing the cooling water, be sure to stop the engine.
- (2) Do not open the pressure cap while the engine is running under heavy loads or immediately after the engine has stopped. Otherwise, hot water may spray out, scalding the operator. So make it a habit to wait for about 10 minutes before opening the cap.
A full tank of cooling water is enough for one day's work. Make it a rule to check the level of the cooling water prior to operation.

■ Checking, Replenishing and Changing Cooling Water

- (1) Remove the radiator pressure cap and check to see that the water level is just below the port. If short, add fresh tap or well water.

Prescribed quantity

B5100D/B6100E	3ℓ (3.2 qts.)
B6100D/B6100E/B7100D	4.6ℓ (4.9 qts.)



CAUTION:

- (1) Never replenish with muddy water or salt water.
 - (2) Securely tighten the pressure cap.
- (2) When draining the used cooling water, open the water drain cock and the pressure cap at the same time. With the pressure cap closed, complete drainage cannot be achieved.

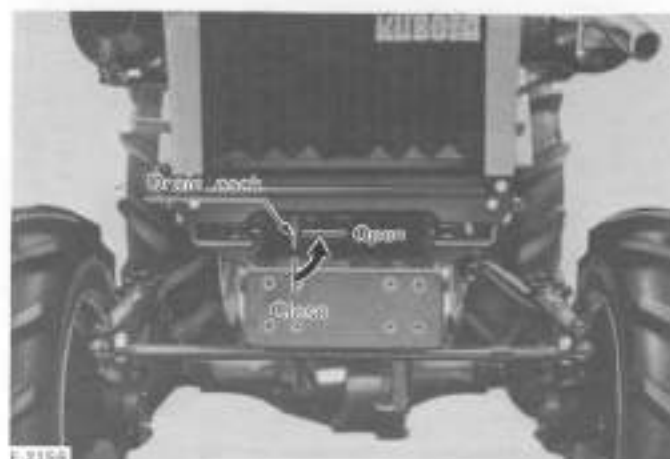

- (3) Be sure to close the pressure cap securely. If the cap is loose or improperly closed, water may spill out and water shortage will result.
- (4) Radiator should be filled with 50/50 parts of anti-freeze and water at all times. The anti-freeze contains a corrosion inhibitor and will allow a higher operating temperature in the radiator during the hot season.
- (5) Do not use an anti-freeze and a fur inhibitor at the same time.

■ Checking and Cleaning Radiator for Flooding

- (1) Adherence of insects and chaff to the radiator net decreases cooling performance. In such cases, detach the net and wash away the obstacles.



- (2) Remove the dust from between the fins and the tube.
- (3) Tighten the fan drive belt as necessary. For this, refer to page 25.
- (4) If fur forms in the tube, clean with the Kubota Fur Inhibitor.

■ Checking Radiator Hose

Checking radiator hose tightness is prescribed about every 150 service hours, but every 6 months is all right so long as service duration does not exceed 150 hours in 6 months.

- (1) If the tightener band is loose, securely retighten and apply a slight coat of oil.
- (2) The radiator hose is made from rubber and tends to age. It must be changed every two years. Together change the tightener band and securely tighten.

■ Kubota Fur Inhibitor No. 11

- (1) The Kubota Fur Inhibitor No. 11 prevents fur formation in the cooling water. Fur, which builds up in either hard or soft water, sharply reduces cooling efficiency.
- (2) The Fur Inhibitor is effective for 3 months so a complete change of cooling water must be done every 3 months.

■ Remedying Water Leakage

- (1) Water leakage can easily be eliminated with the Kubota Radiator Cement No. 40.
- (2) If water leakage should become extremely excessive, consult your local dealer.

■ Cleaning Cooling System

- (1) The water cooling system should be cleaned on the following occasions:
 - Every 500 service hours
 - When adding an anti-freeze solution.
 - When changing from water containing anti-freeze to pure water.
- (2) When cleaning the water cooling system, the Kubota Fur Inhibitor No. 20 is recommended to effectively wash away the built-up fur.

Parts Name	B6100D/B6100E/B7100D		B5100D/B5100E	
	Code Nos.	Unit	Code Nos.	Unit
Radiator hose 1	15371-7285-1	1	15261-7285-1	1
Radiator hose 4	15371-7294-1	1	15261-7294-1	1
Tightener band	15108-7287-3	4	15261-7278-2	3
			15108-7287-3	1

■ Anti-Freeze

If the cooling water freezes, the engine cylinder and radiator may crack. In cold weather when the temperature drops below 0°C (32°F), drain out the water or add a proper amount of anti-freeze when the tractor is shut down.

- (1) There are two types of anti-freeze solutions, permanent type (PT) and semi-permanent type (SPT). For the Kubota Engine, be sure to use the permanent type.
- (2) When anti-freeze is used for the first time, fill and drain clean water two or three times so as to completely clean the inside of the radiator.
- (3) Radiator should be filled with 50/50 parts of anti-freeze and water at all times. The anti-freeze contains a corrosion inhibitor and will allow a higher operating temperature in the radiator during the hot season. Remember that the effective cooling water capacity of the radiator is shown on the table below.

Capacity

B6100D/B6100E/B7100D	4.6ℓ (4.9 qts.)
B5100D/B5100E	3ℓ (3.2 qts.)

- (4) Stir the anti-freeze well in the water and then pour the mixture into the radiator.
- (5) When the cooling water mixed with anti-freeze decreases due to evaporation, replenish with water only. If loss has been due to leaking, water and anti-freeze mixture with the same mix ratio as the original preparation.
- (6) Anti-freeze solutions absorb moisture, so be sure to securely close the container after use.
- (7) Anti-freeze and water should be changed every year.
- (8) Do not use an anti-freeze and a fur inhibitor at the same time. This may cause sludge to form, adversely affecting the engine parts.

7.8 TIRE PRESSURE

Though the tire pressure is factory-set to the prescribed level, it naturally drops slowly in the course of time. Thus, check it everyday and inflate as necessary. To inflate the wheel tires, use an air compressor or hand pump.

	Normal wheel tire pressures	
	Front	Rear
B5100D/B6100D/ B7100D	0.10 MPa (14 psi, 1.0 kgf/cm ²)	0.12 MPa (18 psi, 1.2 kgf/cm ²)
B5100E/B6100E	0.16 MPa (23 psi, 1.6 kgf/cm ²)	0.12 MPa (18 psi, 1.2 kgf/cm ²)

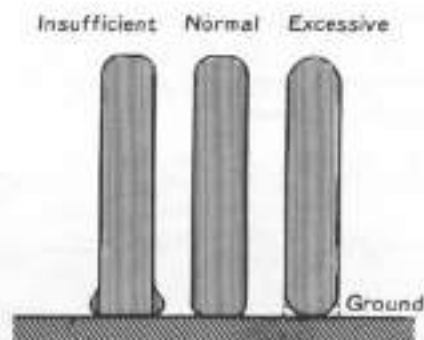

7.9 AIR CLEANER

- (1) As the air cleaner uses a dry element, never apply oil.
- (2) Do not let dust build up to more than a half of the dust cup. Detach the dust cup and throw away the dust—normally once a week, but everyday if working conditions are especially dusty.
- (3) Do not touch the filter element except in cases where cleaning is required.
- (4) When cleaning the element, refer to the Instructions attached.
- (5) If the element is strained with carbon or oil, apply one of the following cleansers:
 - TR-10000 (by Tokyo Filter Co.)
 - ND-1500 (by Japan Donaldson)
- (6) Change the element once yearly or every time the air cleaner is rinsed with water (6 times a year).



CAUTION:

Be sure to refit the dust cup with the arrow ↑ (on the rear) upright. If the dust cup is improperly refitted, dust passes by the dust cup and directly adheres to the element, badly affecting the service life.

7.10 BATTERY



SAFETY PRECAUTION:

- Never take off the cap while the engine is running. Keep electrolyte away from eyes, hands and clothes. If you are spattered with it, wash it away completely with water.

Mishandling the battery shortens the service life and adds to maintenance costs. Be sure to handle it correctly so that it will develop its full potential performance.



- (1) If the battery is dull, the engine is difficult to start and the lamps become dim. It is important to check the battery daily and recharge before such trouble occurs.
- (2) The water in the electrolyte evaporates during recharging. Liquid shortage damages the battery and excessive liquid spills over and damages the tractor body. If short, be sure to top up the battery with distilled water.

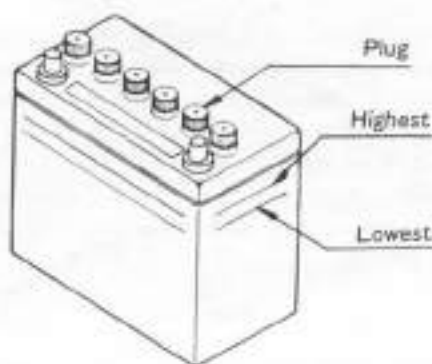

- (3) To top up the battery connect the battery positive terminal to the charger positive terminal and the negative to the negative, then recharge in the standard fashion.
- (4) A boost charge is only for emergencies. It charges partially the battery at a high rate and in a short time. When using a boost-charged battery, it is necessary to recharge the battery as early as possible after the operation has been finished. Failure to do this extremely affects the service life due to overdischarge.

CAUTION:

- (1) When connecting the battery, do not reverse the polarities. Connection with reverse polarities causes troubles to the battery and electrical system in the tractor.
- (2) When disconnecting the cord from the battery, start with the negative terminal first. When connecting, start with the positive terminal first. Reversing the steps may cause short-circuiting, should a screwdriver touch the terminals.

■ Directions for Storage

- (1) When shutting down the tractor for long periods of time, remove the battery from the tractor, top up it, adjust the electrolyte to the proper level and store in a dry place out of direct sunlight.
- (2) The battery self-discharges even while it is stored. Recharge it once a month in hot seasons and once every two months in cold seasons.

8. Adjustments



SAFETY PRECAUTION:

- When making adjustments, park the tractor on flat ground and apply the parking brake.

8.1 FAN DRIVE BELT TENSION

If the fan drive belt becomes loose, the engine may sometimes overheat. When the belt is deflected excessively, loosen the adjusting nut and tighten the tension bolt to stretch the belt. After adjustment, securely tighten the adjusting nut.

Moderate belt tension:

The belt should deflect approx. 10mm (25/64 in.) when the center of the belt is depressed with a finger pressure of 98N (10 kg, 22 lbs.).

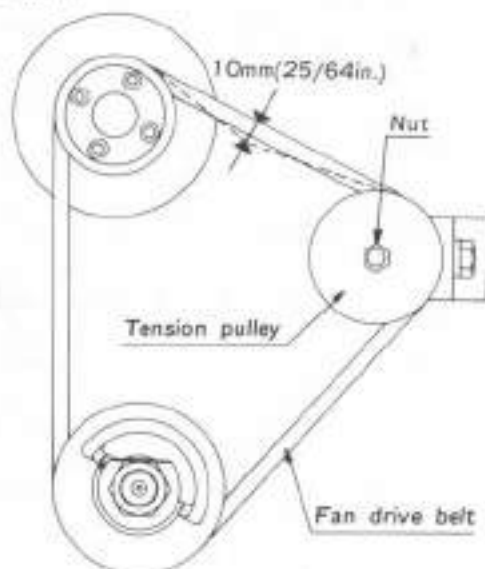

8.2 CLUTCH

Moderate clutch pedal play ranges from 2 to 4mm (5/64 to 5/32 in.) and moderate clutch pedal travel is 8mm (5/16 in.).



F-2257

■ B6100D/B6100E/B7100D

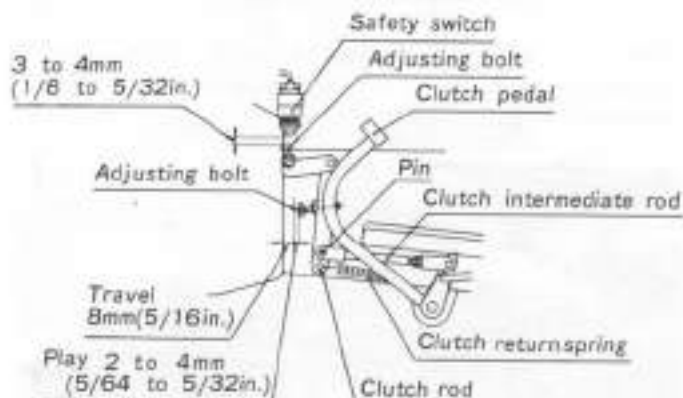

F-2039

■ B5100D/B5100E

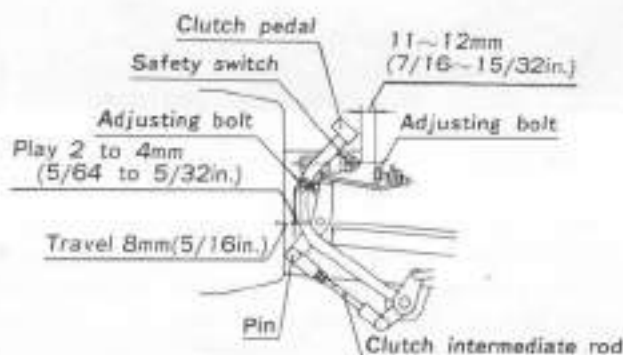

F-2040

- If the clutch becomes difficult to disengage or pedal play decreases, adjust the length of the intermediate rod after removing the pin. When the clutch is difficult to disengage, extend the intermediate rod. When the clutch play is too little, shorten the intermediate rod.
- To adjust pedal travel, loosen the lock nut and turn the adjusting bolt to the point where the clutch is disengaged completely.

8.3 Brake

If brake pedal travel becomes too great or travel varies too greatly between the right and left pedals, loosen the turnbuckle lock nut and turn the turnbuckle in the desired direction until the proper pedal travel is achieved. Moderate right and left pedal play ranges from 10 to 30mm (25/64 to 1-3/16 in.).

After adjustment, interlock the right and left brake pedals and finally tighten the lock nut securely.

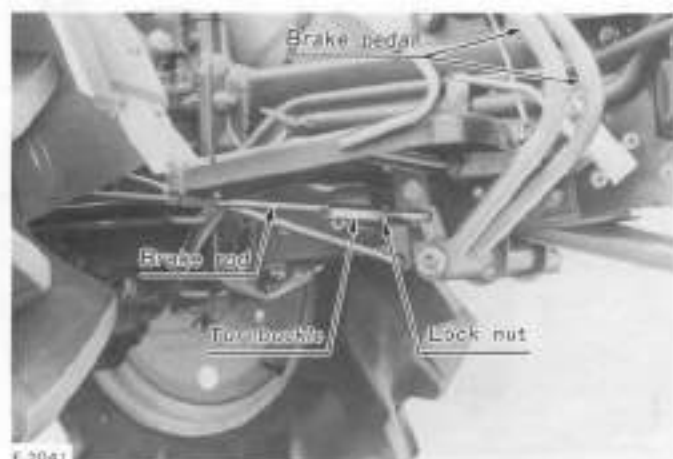

F 2041

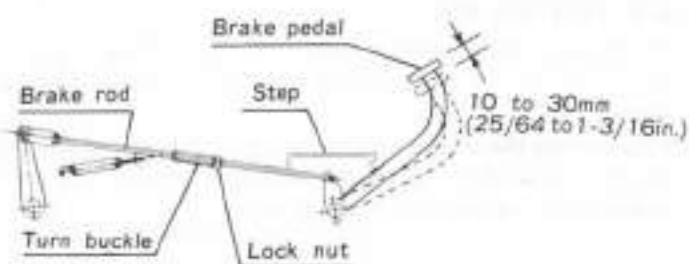

8.4 STEERING WHEEL

Moderate steering wheel play is 10 to 30mm (25/64 to 1-3/16 in.). To adjust this, loosen the lock nut and turn the adjusting bolt to the right. After adjustment, securely retighten the nut.



F 2003

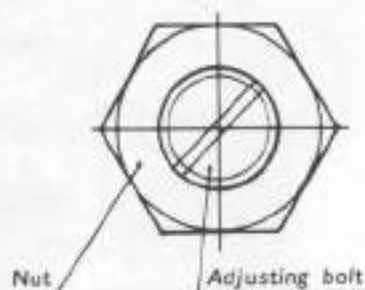

8.5 IMPLEMENT LOWERING SPEED

Implement lowering speed can be adjusted in accordance with the type of the implement and operating conditions. To do this, after loosening the lock nut, tighten or loosen the adjusting bolt on the hydraulic control valve. Tightening the adjusting bolt slows down the lowering speed while loosening it accelerates the speed. After adjustment, securely tighten the lock nut.

Note that the proper lowering speed of a rotary tiller is such that it takes two or three seconds to descend from the top position to the ground.



F 2004

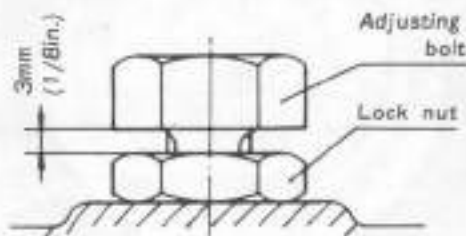

8.6 IMPLEMENT LIFTING AND LOWERING LIMITS

The implement lifting and lowering limits can be changed by shifting the locker (A) or (B).

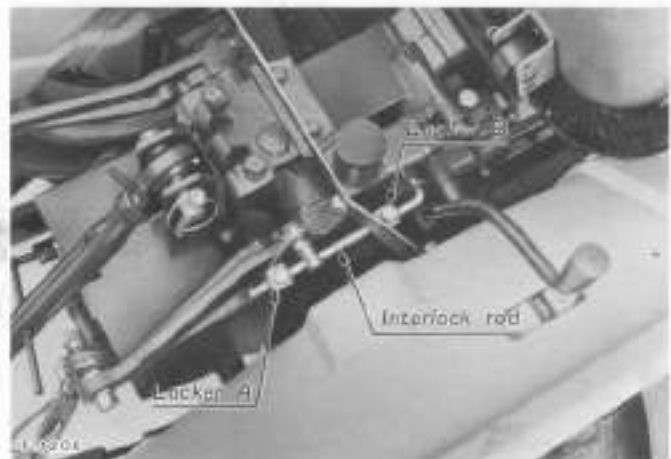

F 2004

■ Lower Limit

The lower limit can be changed by shifting the fixing position of the locker (A). Shifting the locker (A) backward lowers the limit and shifting it forward raises the limit.

■ Upper Limit

The upper limit can be changed by shifting the fixing position of the locker (B). Shifting the locker (B) backward lowers the upper limit and shifting it forward raises the limit.

8.7 REAR WHEEL TREAD

The rear wheel is fixed to the hexagonal axle and hub by the use of a pin and set bolt. Rear wheel tread can be changed at 3 steps (B6100D/B6100E/B7100D), 2 steps (B5100D/B5100E) by selecting one of the pin holes on the axle. Adjust the rear wheel tread according to operating conditions.

Tread (Between the center of the tires)

B6100D/B6100E/B7100D	660mm, 710mm, 760mm (26 in., 28 in., 30 in.)
B5100D/B5100E	640mm, 740mm (25 in., 29 in.)



F-2256

8.8 TOE-IN

The toe-in needs to be adjusted if the tractor runs unstably or if the steering wheel becomes heavy or difficult to handle.

Measure the front wheel distances (AB and CD) and adjust to the following value.

CD minus AB should be approximately zero to 5mm (0.2 in.), which is common to the B5100D/B5100E/B6100D/B6100E/B7100D. To perform this adjustment, loosen the tierod lock nut and turn the tierod the desired number of turns.

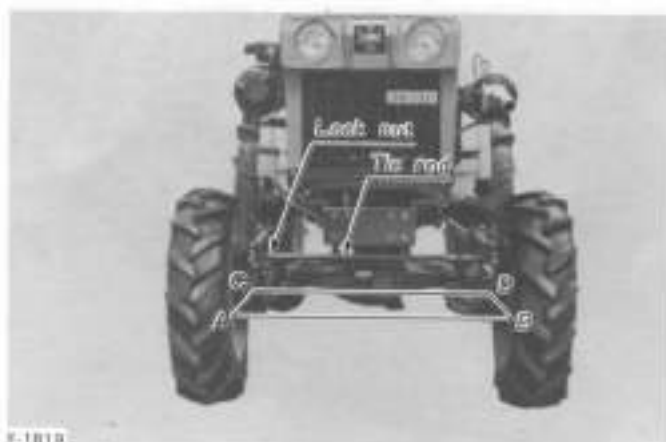

F-1819

8.9 CENTER PIN

If cross-axle play occurs between the front wheel support and the front axle, it must be eliminated in the following fashion:

First remove the set spring, then retighten the slotted nut on the front axle while turning the steering wheel until the play is eliminated. Lastly replace the set spring.



F-1819

8.10 EXHAUST PIPE WITH MUFFLER

The exhaust pipe can be rotated. Adjust this properly while the tractor operate between the crop rows.



F-1817

9. Troubleshooting

9.1 BATTERY TROUBLESHOOTING

Trouble	Cause	Countermeasure	Preventive measure
The cell starter does not start.	* Lights have been overused until they become dim.	* Charge the battery for a long enough time by the standard method.	* Charge the battery properly, or avoid overdischarging.
	* Battery has not been recharged.		
	* Poor terminal connection.	* Clean the terminal and tighten securely.	* Keep the terminal clean and tight. Apply grease and treat with anti-corrosives.
	* Battery is dead.	* Renew battery.	
The cell starter does not start even after changing, and lights soon become dim.	* Insufficient charging.	* Charge the battery for a long enough time by the usual method.	* Top up the battery before use.
When viewed from top, the top of plates looks whitish.	* Battery was used with an insufficient amount of electrolyte.	* Add distilled water and charge the battery.	* Regularly check the electrolyte level.
	* Battery was used too much without recharging (overdischarged).	* Charge the battery for a long enough time by the usual method.	* Charge the battery properly, or avoid overdischarging.
Recharging is impossible.	* Battery is dead.	* Renew battery.	
Terminals are severely corroded and heat up.	* Poor terminal connection or stained terminal	* Clean the terminal and tighten securely.	* Keep the terminal clean and tight. Apply grease and treat with anti-corrosives.
Battery electrolyte level drops rapidly.	* There is a crack or pin holes in the electrolytic cells.	* Renew electrolytic cells.	* Install the electrolytic cells securely.

If you have any questions, contact your Kubota dealer.

9.2 ENGINE TROUBLESHOOTING

If something is wrong with the engine, refer to the table below for the cause and its corrective measure.

Trouble	Cause	Countermeasure
Engine is difficult to start.	1) No fuel flows.	1) Check the fuel tank and the fuel filter, and remove dirt buildup. 2) All fuel passes through the fuel filter and much dust is caught in it. Should there be deposits on the filter, replace it.
	2) Air and water is in the fuel system.	1) Check to see if the fuel pipe coupler bolt and nut are tight. 2) Bleed the fuel system (See page 16)
	3) In winter, oil viscosity increases, and engine revolution is heavy.	1) Pour hot water over the radiator. 2) Use oils of different viscosities, depending on ambient temperatures.
	4) Battery becomes dull and the engine does not overcome compression.	1) Charge the battery. 2) Use the decomp knob. 3) In cold weather, always remove the battery from the engine, charge it and store it indoors. Install it in the engine only when the tractor is going to be used.
Insufficient engine power.	1) Insufficient fuel. 2) The air cleaner is clogged.	Check the fuel system. Clean the element.
Engine stops suddenly.	Insufficient fuel.	1) Refuel. 2) Check to see if air mingles in the fuel system.
Exhaust fumes are storage color.	Fuel quality is poor.	Change to a quality fuel.

If you have any questions, contact your Kubota dealer.

10. Long-Term Storage



SAFETY PRECAUTION:

- When storing, remove the key from the key switch.

When the tractor is not going to operate for two or three months or longer, clean stains off well and perform the following treatment before storage.

- (1) Repair the parts where needed.
- (2) Check bolts and nuts for looseness and tighten as necessary.
- (3) Apply grease or engine oil to the parts most likely to rust.
- (4) Remove the weight.
- (5) Pump up the wheel tires to a little above the standard pressure levels.
- (6) Change the engine oil and run the engine for five minutes so that the oil circulates through the entire system.
- (7) Stop the engine by fully pulling out the engine stop lever.
- (8) Drain the radiator.

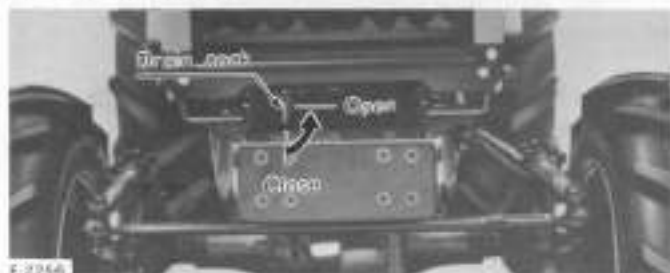

F 2256

- (9) Lock the clutch pedal with the provided wooden block. If the tractor is stored for a long period with the clutch left engaged, the clutch disc may rust, rendering it inoperative.
- (10) Lower the implement to the ground.
- (11) Remove the battery from the tractor, recharge it, adjust the electrolyte to the proper level, and store in a dry place out of direct sunlight.
- (12) The battery runs down over time even while in storage. Recharge it once a month in hot seasons and once every two months in cold seasons.
- (13) Store the tractor where dry and sheltered from rain. Further cover the tractor with a sheet.
- (14) When leaving the tractor outdoors, keep the muffler out of the rain.

CAUTION:

To clean the tractor stop the engine. If you must clean the tractor with the engine going, utmost care should be taken not to allow water to enter the air cleaner. Engine trouble may occur if water enter the engine.

11. Three-point Hitch

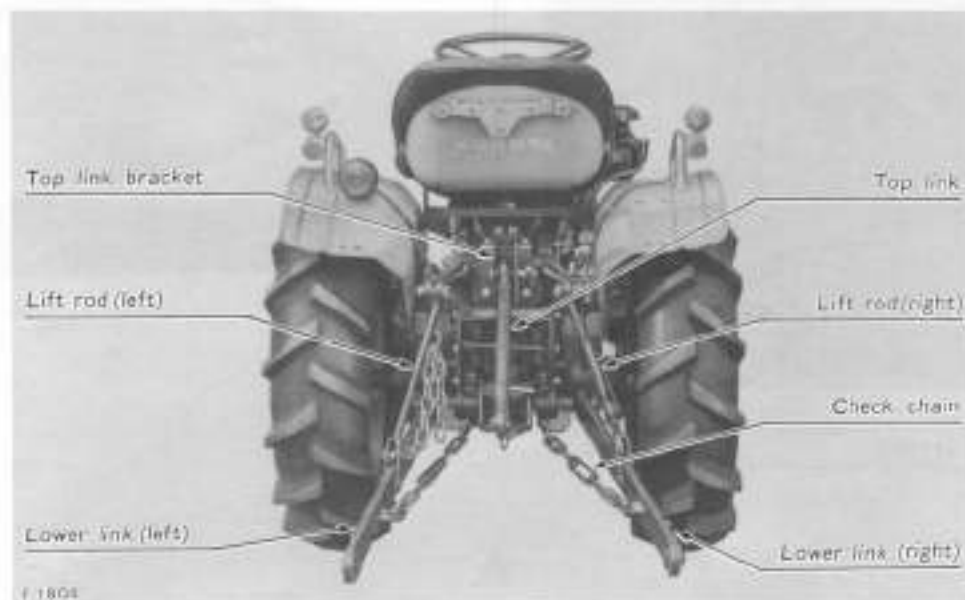

F 1804

11.1 THREE-POINT HITCH ADJUSTMENT

■ Top Link

Implement tilt can be adjusted by changing the length of the top link. Shortening the top link, for example, tilts the implement head down, thereby enhancing plowing efficiency.

■ Lift Rod

The lift rod (right) is provided with an adjustment handle for extending or shortening the lift rod. To level the implement, operate the handle.

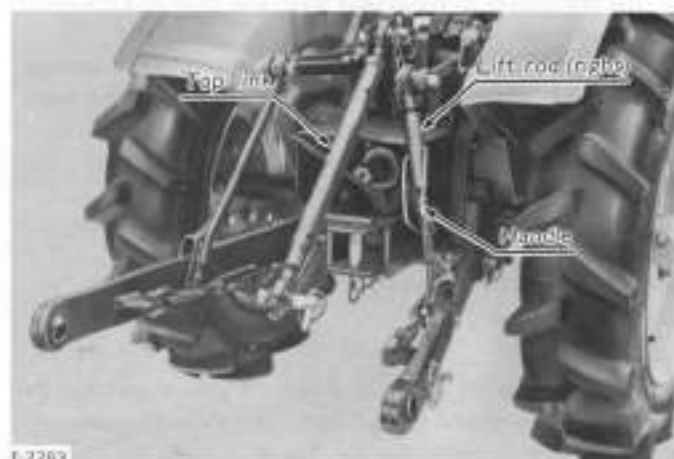

F-2253

■ Check Chain

The check chains prevent 3-point hitch mounted implements from swaying and keep the bottom links from rubbing against the inside of the rear tires. The check chains may be adjusted by turning the check chain turnbuckle. If the check chains are too loose, 3-point mounted implements will sway and the bottom links will rub against the inside of the rear tires. To properly adjust check chain tension, turn the check chain turnbuckle until it is hand-tight. Once the check chain is adjusted, tighten the locking nuts against the turnbuckle.



F-2262

CAUTION

When setting the universal joint of implement to the PTO shaft, be careful to follow the instructions below.

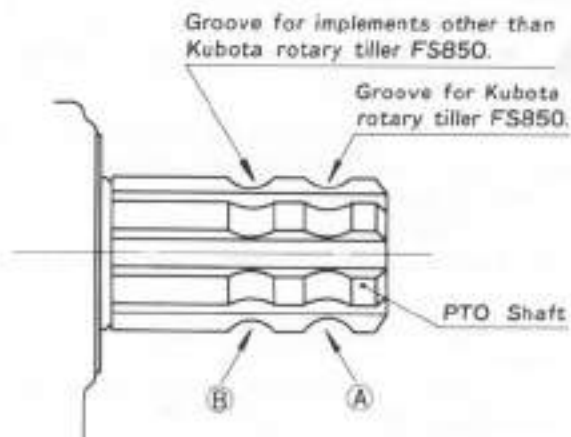

F-1207

(Kubota rotary tiller model FS850)

Set the joint in (A) groove. If the joint is set in (B) groove and the implement lifted to a high position, the angle of the joint becomes bigger and the joint will touch the PTO shaft.

(Implements other than Kubota rotary tiller model FS850)

Set the joint in (B) groove.

It would be better to set the joint as close to the tractor as possible.

Then it would be possible to get longer life of the bearing of the PTO shaft and joint.

12. Options

- R.O.P.S. (B1022) Can't be used with BK-7A trencher mounted
- 2 Post with seat belt & bolt.
ROPS is strongly recommended for your safety.

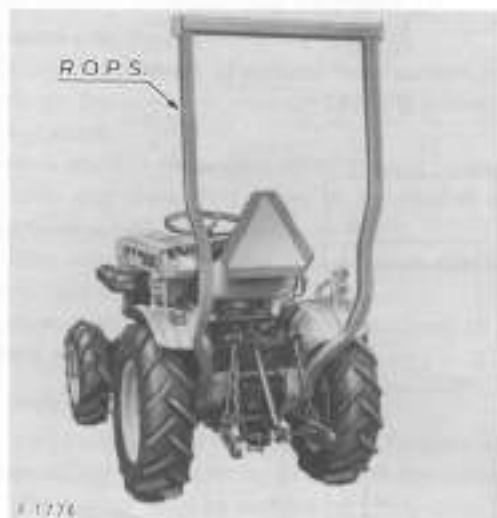

- Implement Lock Chain (B5100D/B5100E)

- Horn (B5100D/B5100E)

Code No.	66494-8120-1
----------	--------------

- Hour Meter (B5100E/B6100E)

Code No.	66704-8210-1
----------	--------------

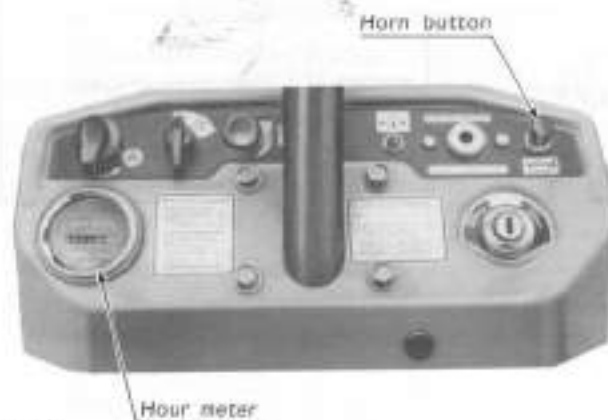

- Upright Muffler

The horizontal muffler can be converted into an upright muffler with minor changes of parts.

To convert:

- (1) Remove 4 bolts (M8) fastening the elbow and muffler, then detach the stay.
- (2) Turn the muffler inlet upright and lock with 4 nuts (M8).
- (3) Replace the horizontal exhaust pipe with an upright exhaust pipe and clamp with the band.

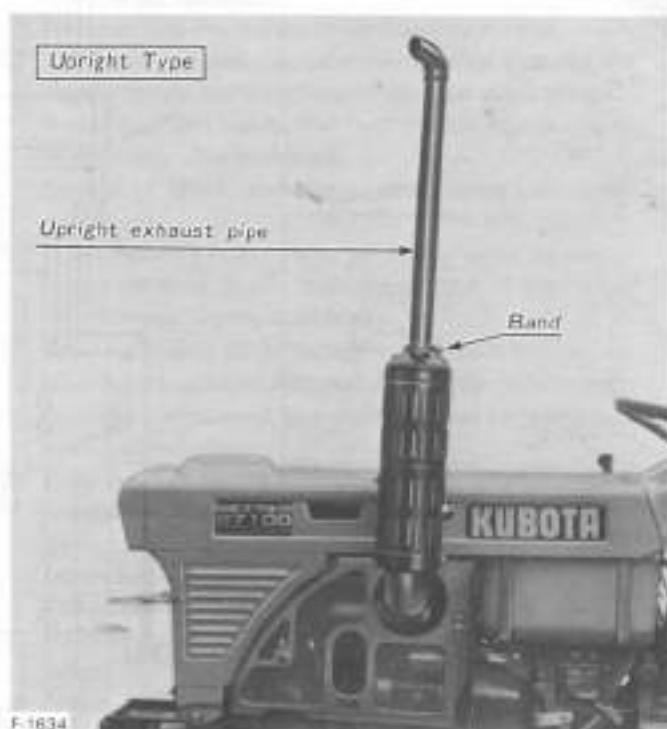

Code No.	66711-8251-1
----------	--------------

13. Wiring Diagram

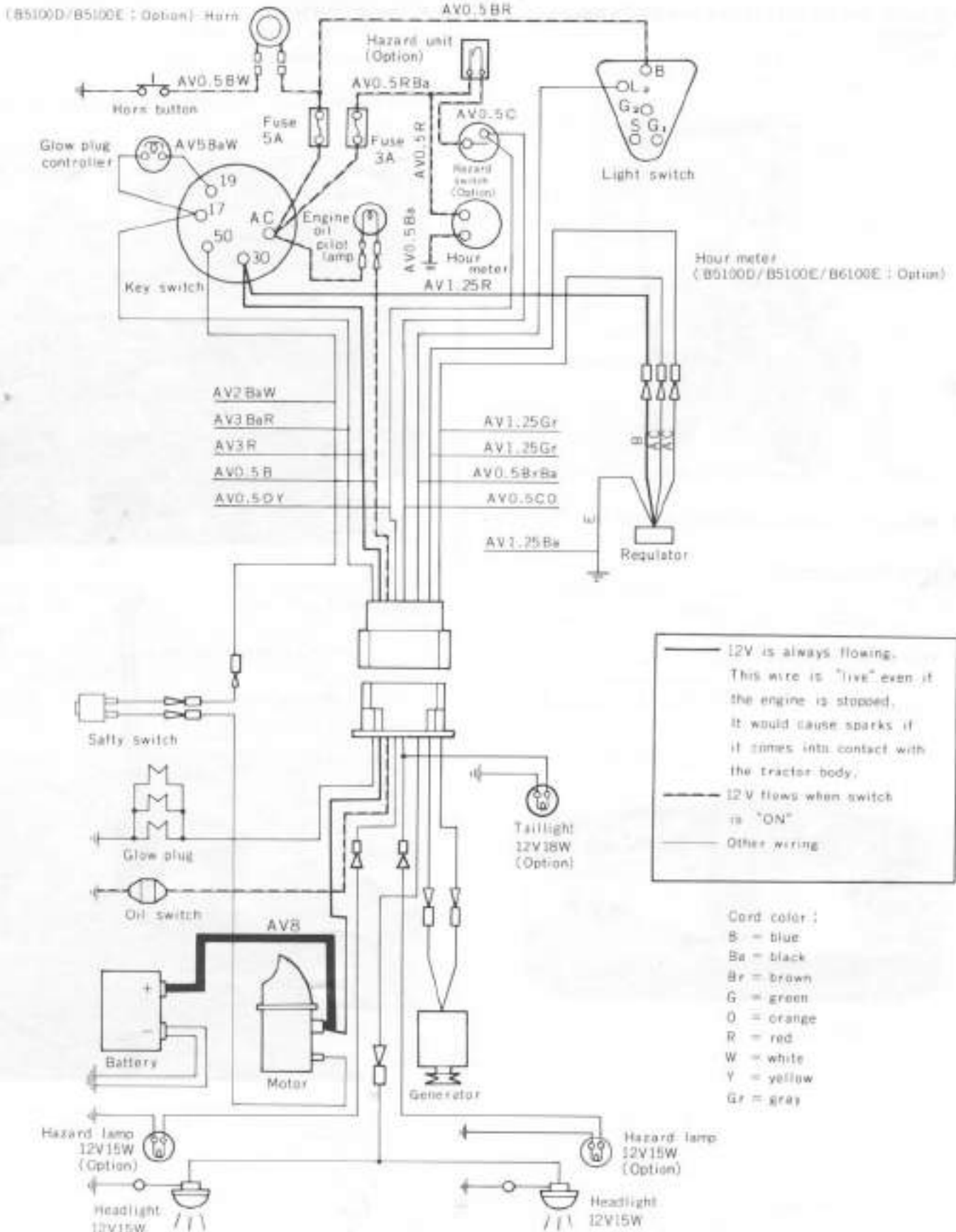

Kubota, Ltd. is . . .

Since its inception in 1890, Kubota, Ltd. has grown to rank as one of the major firms in Japan.

To achieve this status, the company has through the years diversified the range of its products and services to a remarkable extent. Today, 19 plants and 19,000 employees produce over 1,000 different items, large and small.

All these products, and all the services which accompany them, however, are unified by one central commitment. Kubota makes products which, taken on a national scale, are basic necessities. Products which are indispensable. Products intended to help individuals and nations fulfill the potential inherent in their environment. For Kubota is the Basic Necessities Giant.

This potential includes water supply, food from the soil and from the sea, industrial development, architecture, construction, and transportation.

Thousands of people depend on Kubota's know-how, technology, experience and customer service. You too can depend on Kubota.



KUBOTA

- **Head Office** : 2-47, Shikishinagashi 1-chome, Naniwa-ku, OSAKA 556-91 JAPAN
Telephone : (06) 648-2111
Cable : IRONKUBOTA OSAKA
Telex : 526-7785 KUBOTA J
- **Tokyo Office** : 3, Nihonbashi-muramachi 3-chome, Chuo-ku, Tokyo, Japan
Telephone : (03) 270-2111
Cable : IRONKUBOTA TOKYO
Telex : 222-3681 KUBOTA J
- **Kubota America Corporation** : 623 West Sixth Street, Suite 1113, Los Angeles, California 90014, U.S.A.
Telephone : (Area Code 213) 627-6377
Cable : IRONKUBOTA LOSANGELESCALIF
Telex : 230-67-3238 IRONKUBOTA LSA
- **Bangkok Liaison Office** : Thaniya Bldg. 4th Floor, 62, Silom Road, Bangkok, Thailand
Telephone : 37880, 37882
Cable : KUBOTA BANGKOK
Telex : 2369 KUBOTA TH
- **Jakarta Office** : P.T. Skyline Building No.9, Jl. M.H. Thamrin, Jakarta, Indonesia
- **Athens Office** : 20, 28th of October Street Filorise, Athens, Greece
Telephone : 682-5646
Telex : 214-227, EXSE, GR
- **Affiliated Companies**
 - Brazil** : KUBOTA-TEKKO DO BRASIL INDUSTRIA E COMERCIO, LTDA.
Rua Pedro America 32, C.P. 5228, Sao Paulo, Brazil
 - Taiwan** : SHIN TAIWAN AGRICULTURAL MACHINERY CO., LTD.
282, Se-chuen 2nd Road, Kaohsiung, Taiwan
 - Malaysia** : PAN MALAYSIAN AGRICULTURAL MACHINERY SDN. BERHAD
Galan 205, Petaling Jaya, P. O. Box No. 2, Selangor, Malaysia
 - U.S.A.** : KUBOTA TRACTOR CORPORATION
550 West Artesia Blvd, P.O.Box 7020, Compton, California, 90220, U.S.A.
 - Indonesia** : P. T. KUBOTA INDONESIA
Dji Setya Budi, 279, Semarang, Indonesia
 - France** : KUBOTA TRACTOR EUROPE S. A.
12, Boulevard des Martyrs de Chateaubriant Zone Industrielle BP 88 95101
Argenteuil Cedex FRANCE
 - Iran** : IRAN KUBOTA INDUSTRIAL WORKS, LTD.
Alborz Industrial City IP. O. Box 1253 Gaevin, Iran
 - Canada** : KUBOTA TRACTOR CANADA LTD.
390 Sawlows Road, Unit 2, Markham, Ontario L3R 1G2, Can.