

SERVICE MANUAL

Кубота

MODELS: B1600 - B1600DT



Contents

Maintenance and guarantee	1
Small special car	2
Knowledge of equipment	3
Switch and Metre.....	3
Operation equipment	5
Rotary Tiller up?down.	9
Caltivate Adjuster.....	10
3 Points Linkage	10
The method of skillful operation	13
Starting of Engine ..	13
Stop of Engine ..	14
It accustoms and is about operation....	15
Cautions .17 of the receipts and payments to Field	
Start operation (cold season).....	15
The way of start and a run	15
The way of a stop	16
The method of operation on a slope ..	17
The way of revolution	17
Loading/unloading	17
Cautions under public road run	17
Loading to Truck	18
Rotary equipment	19
How to remove Rotary equipment ...	19
How to attach the PTO equipment of Side Drive (RS form)	20
How to attach Tiller Tine of Side Drive (RS form)	21
How to attach Tiller Tine of Centre Drive (RK form)	21
The attachment-and-detachment method	22
Regulation of Rear Cover	23
How to treat Rotary Tiller	23
Effective use of Rotary Tiller	24
Cautions at a farm of handling	26

About check before work (Act check)27
Check Points.....27	How to Check.....27
Simple care and measures of a tractor.....	3 1
Fuel.....31	Break Adjustment.....41
A way of ventilation.....31	Adjust of Clutch.....41
Refueling and exchange oil.....32	Adjust of Fan Belt.....41
Exchange filters.....34	Adjust of Steering wheel.....42
Exchange Coolant.....35	Toe In check and adjust.....42
Exchange Air Cleaner Element.....36	Front Axle leg gutter adjust.....42
Battery Liquid supply.....37	Adjust of PTO rod.....43
Check of Pipes.....37	Exchange Fuse and Bulb.....43
Injection Points of Grease.....38	Care of Long-Term Storage.....44
Adjust of wheel width.....39	periodic inspection point table.....45
Adjust of lifting machine.....40	Malfunction and measures of an engine.....46
Adjust of Cultivate Speed.....40	

Additional	4 7
Attachment.....47		Wiring.....55
Implement50		State Inspection Report.....56
Specification.....53		recommended oil grease.....57

Switch and Indicator

Switch and Indicator

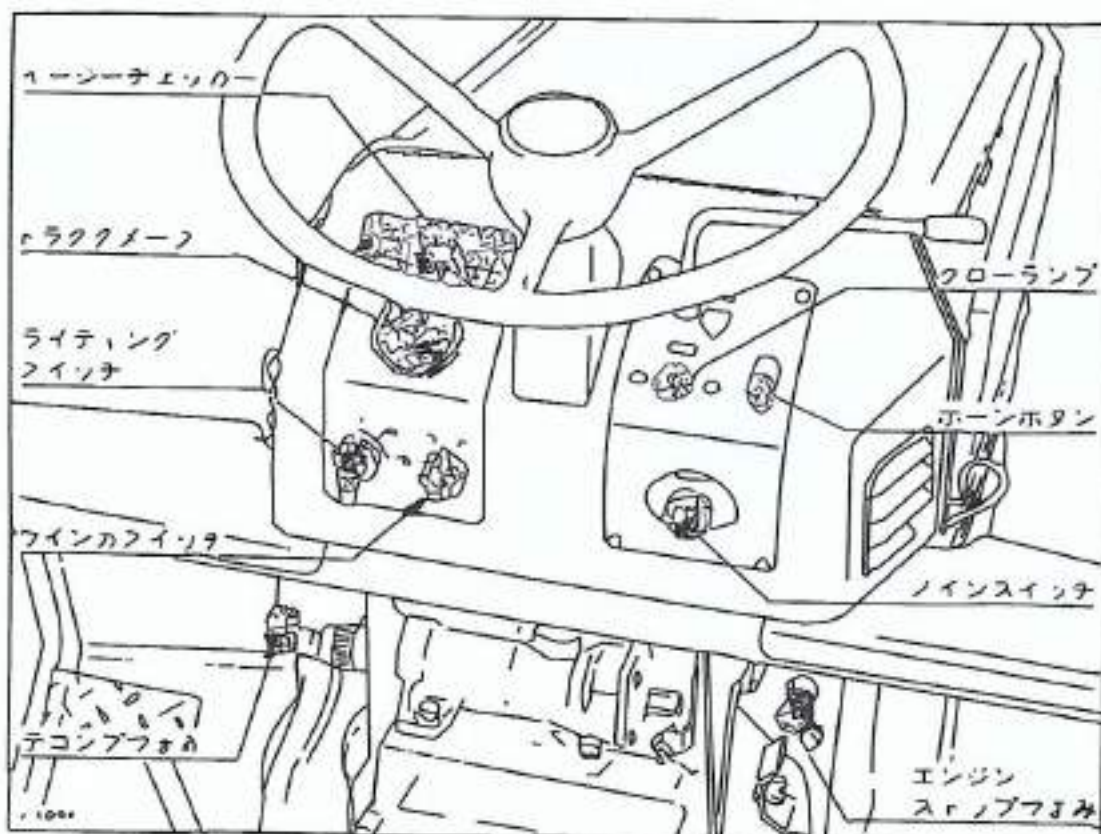

■Main Switch

-Key
- ◎Engine Running position
- GlowGlow Heating position
- StartA clutch steps much,
Start engine position

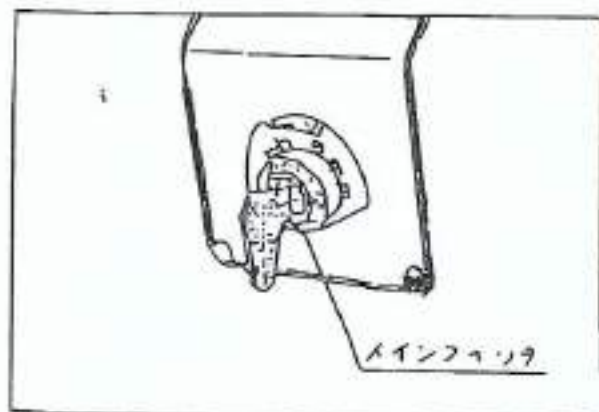

■Lighting Switch

- 1.....head lamp upswing position
- 2.....head lamp downswing position
- OFF.....Head lamp off position

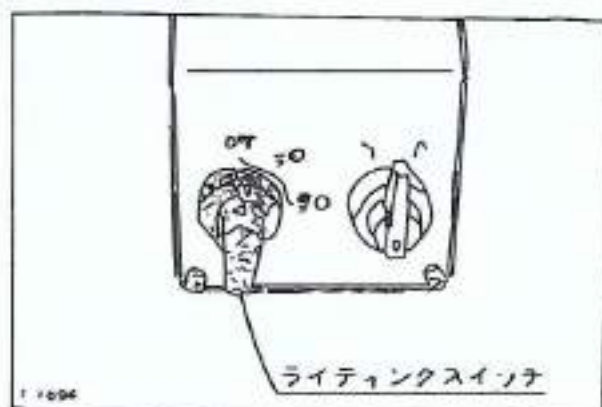

■ The glow switch

Preheating status in the combustion chamber is shown.

■ The decomp control

The compression of 引< and the engine goes through the decomp.

Use in the following case.

(1)

When starting at the time of the cold season cold sake

(2)

In case of the battery charging rate lack

[Note]

● After decomp use, reset a control surely beforehand.

When neglecting, it becomes in the compression leakage boiling of an engine and the engine output doesn't come out.

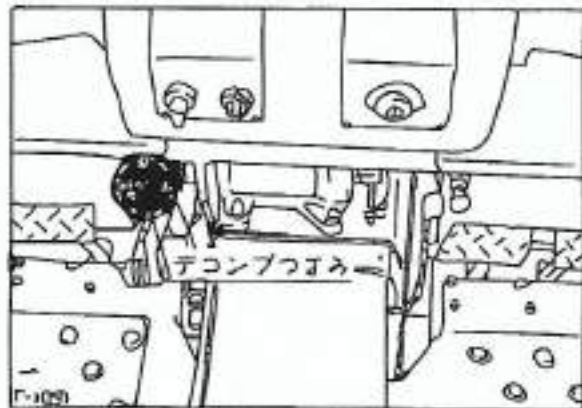

■ The turn signal switch

(1) When operating to the direction of the turning-over, the turn signal lamp blinks.

(2) If the turning-over ends, let's return a switch to Central.

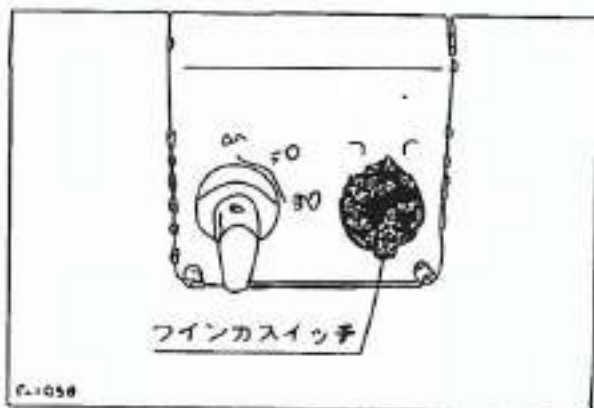

■ The horn buttons

The horn sounds when making a battery switch the position of "◎" and pressing a horn buttons.

■ イージーチェッカー

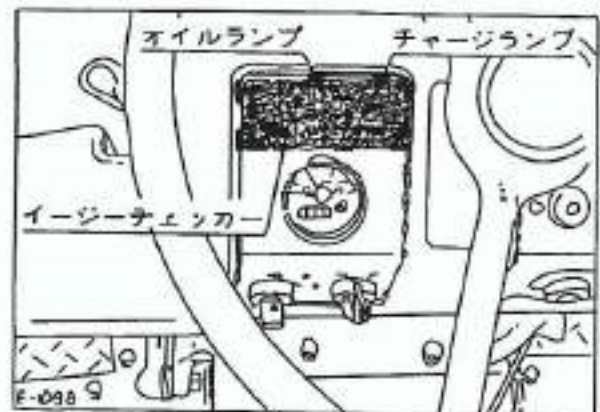

◆ The oil lamp

It is the oil pressure warning light which lights up when the lubrication system is a malfunction while the engine turns.

It lights up when making main switch "◎" in the engine not running and it goes out when starting. At the time as it lit up, check the engine oil quantity.

◆ The charge lamp

It is the charge warning light which lights up when the charging system is a malfunction while the engine turns. It lights up when making a battery switch "◎" in the engine not running and it goes out when starting.

[Note]

● Only by the easy checker, the daily inspection check finishing. surely.

(Page 27 everyday check-up reference)

■ The tractor meter

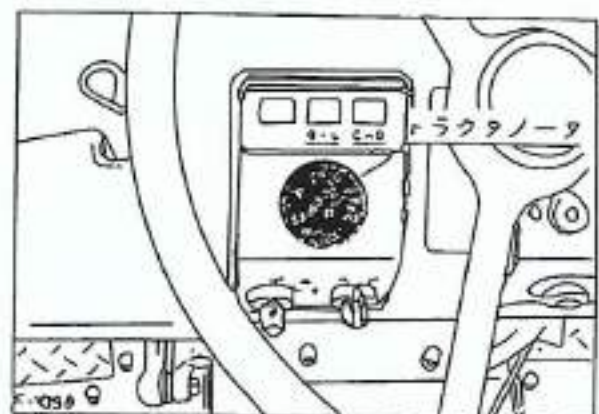

◆ The elapsed time integrator

The time when using an engine in the rated-revolution is shown.

It is a ◆ engine tach indicator in 6 minutes in the " minute " unit time and 170 hours of it becoming.

[ex.] 0170(1)..... when doing the figure while white boils, being sextuple.

A 1 minute engine rotation number is shown.

■ Bonnet and a safe cover open

(1) When Locke lifts a loser when pull bonnet credit metal fittings, a bonnet opens.

(2) Lock a bonnet with a bonnet stopper when open bonnet.

When closed, please do shut after lifting a bonnet stopper in an arrow direction.



(3) When remove disassembly of safe cover right and left just to take off a bolt.

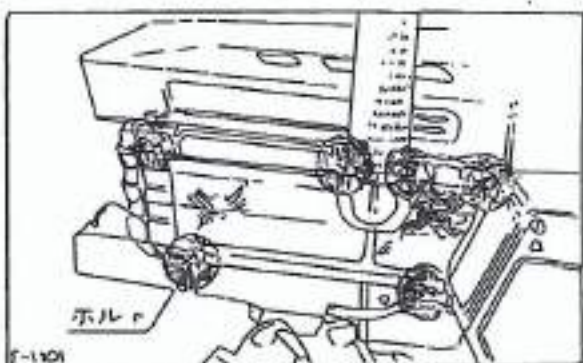
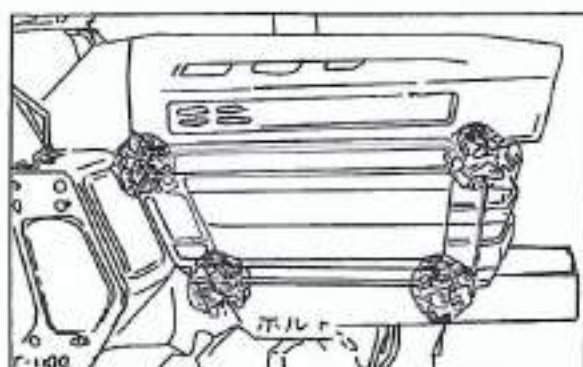

Operation Equipment

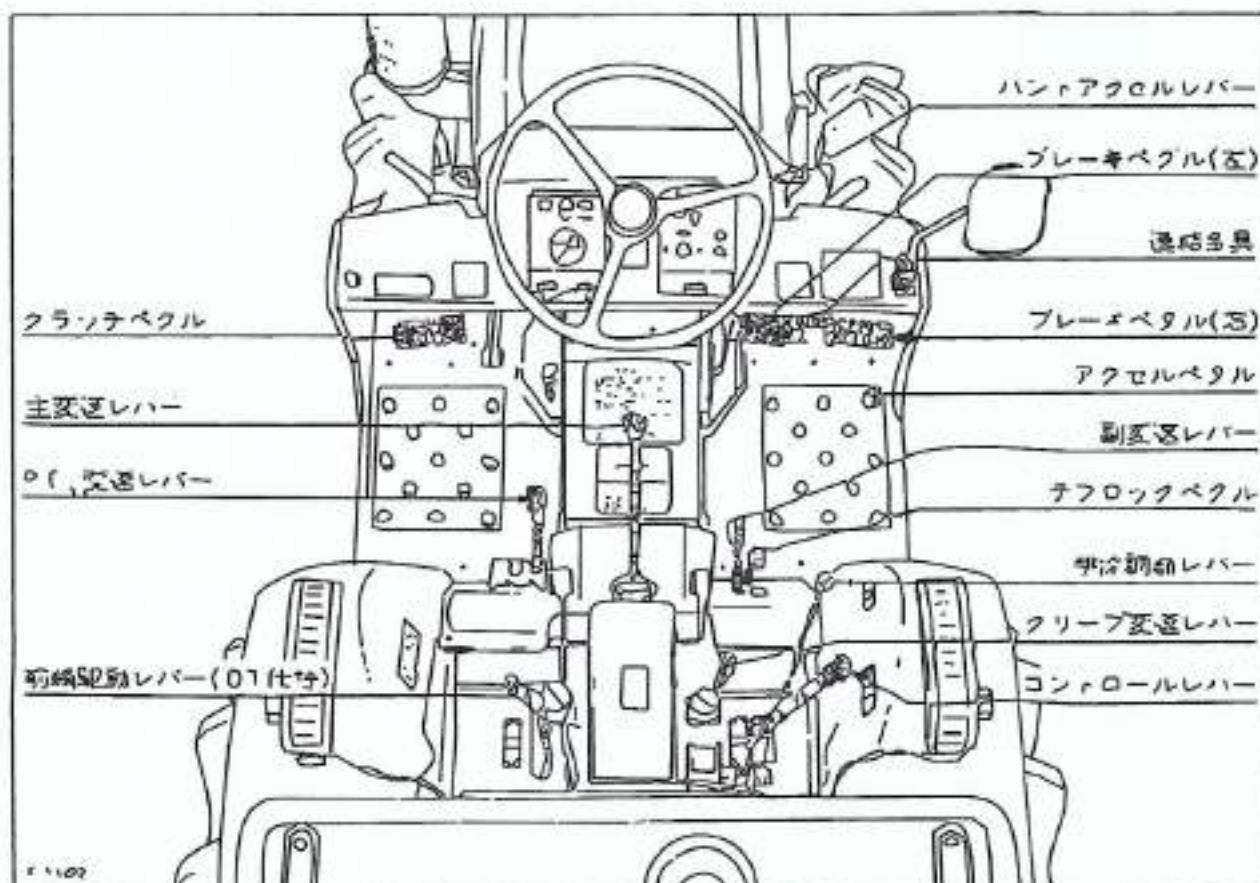

- The main gearshift lever
- A vice-gearshift lever
- A creep gearshift lever

It provide by putting three levers together whether it is tractor speed of 12 steps of forward / four steps of reverse

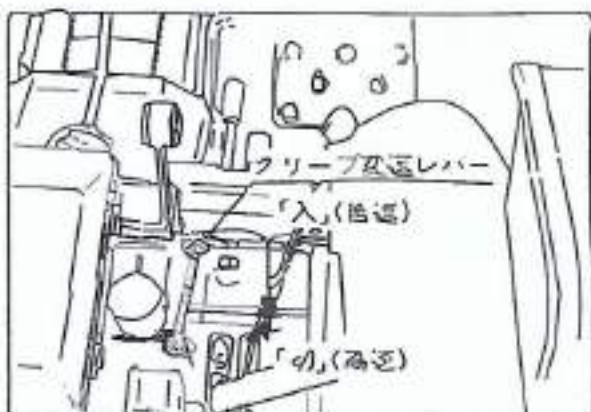
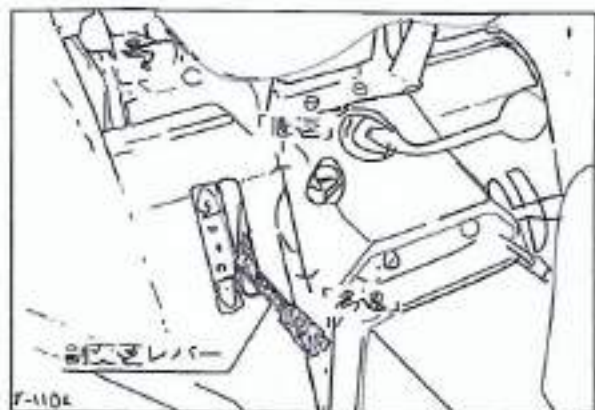

◆ How to use super low speed [creep speed]
Super low speed (creep speed) causes trouble when I take the wrong use and handling.
Please use it after attention about next.

(1) Usable work

- in case deep cultivating / fine soil tiller work by a rotary.
- When use for hard soil by normal speed.
- It work on transplant by a planter.

● Work (limited for agriculture) by a trencher for agriculture.

● Loading in to a car, loading and unloading.

(2) The work that It cannot use (It cause trouble)

● It work on escape from a submergence state in an ill-drained paddy.

● Traction / trailer work.

● Front loader work.

● Front blade work (The snow-removal work.)

● Engineering works work.

● Comings and goes to Field.

(3) When It use super low speed (creep speed).

Please protect next by all means.

● Shifting please perform a lot of clutches after stepping.

● Please perform departure after taking off an emergency brake by all means.

● A stop. Please take Break after cutting a clutch by all means.

[Attention]

● Because rotary power of an axle becomes very strong at super low speed (creep speed). It do not hear brakes even if I strongly step on only a brake pedal. It cause trouble.

■ A hand accelerator lever and accelerator pedal hand accelerator re are ruined.....It use it at the time of farming mainly.
An accelerator pedal.....It use it at the time of a road run mainly.

.. which an accelerator pedal links an accelerator lever, and step in pedalAn engine turn is finished.

It separate a foot from a pedal.....An idling state.



■ The engine-stop control

When pulling a control to the full, the engine stops. After stop, always push a stop control immediately and prepare for the following start.

To be as it pulled start.

Also, as for being as station on the way, the engine output doesn't come out.

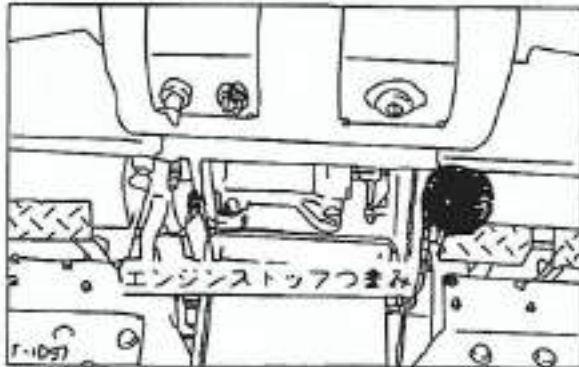

■ The clutch pedal

Clutch is the equipment which continues intermittently in each operation part in the engine power. A clutch is broken in the pedal when stepping. The clutch leads when separating a leg from the pedal.

■ The brake pedal

By the equipment that the brake makes a fuselage stop compulsorily. By the condition of to have hung a connecting-fitting on the transit-time of the road of different from the general vehicle, each of either side is independent and only one ring of the rear wheel can hang boiling Brake.

By the condition of to have removed a connecting-fitting at the time of the farming



Safety Points

● During road moving, the upslope and downhill and job site crossing, always do either side of the brake pedal at connection with the connecting-fitting.

■ The parking brake

The nail meshes in the ditch boiling when connecting a brake pedal on either side and stepping and raising a brake lock lever and the parking brake hangs.

Release from the pedal if stepping when removing

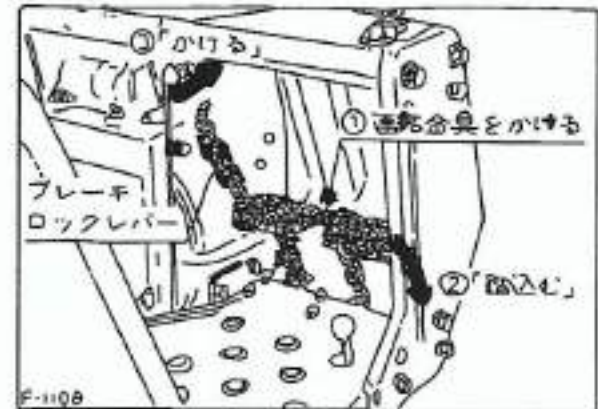

■ The diff-lock pedal

It is the equipment which is driven at the turning speed with the same rear wheel on either side and there is an effect in the slippery prevention. A pedal is locked when stepping. It comes automatically when separating a leg from the pedal.

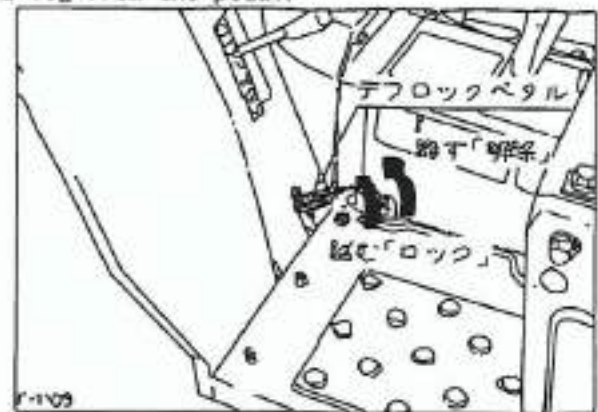

◆ How to use of the diff-lock

Be careful because it is very useful when using a diff-lock skillfully but it causes the danger such as the tumble and the trouble when making a mistake in the usage.

- (1) When slippery and one wheel can not go straight on in going in and out of to a farm and front Rhoda's work, and so on
- (2) When one wheel goes into the weak place of the part of the farm, and slippery and it becomes difficult for there to be running
- (3) When the wheel is slippery with the work which needs tractive force as the plow work, and so on

【 Note 】

(1) When putting a diff-lock, do after lowering an engine turn. (2) When putting a diff-lock (working a diff-lock pedal), don't turn over by all means. It causes the trouble when turning over. (3) When it is difficult for the diff-lock to come off, disengage the clutch or step on Brake Pedal alternately lightly on either side. (It causes the trouble when stepping strongly.)

Safety Points

● It is very dangerous in case of being as it put a diff-lock and turning over. Always remove before turning-over

It sometimes causes a life accident when not following the above.

■ PTO gear lever

The gears can be changed of the turning speed of the PTO axis (the power taking-out axis) to 3 steps.

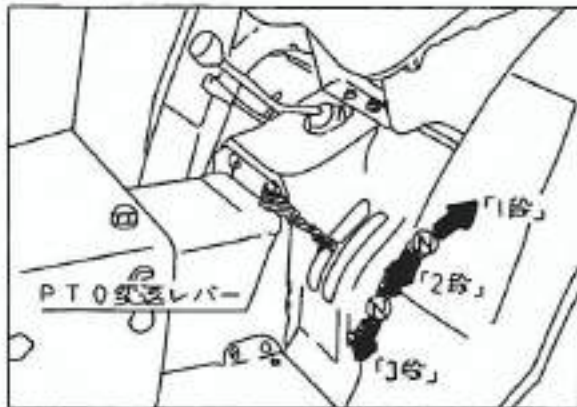

■ The front-wheel lever 【 DT type 】

A front wheel is driven when stepping and making a lever "入" in the clutch pedal with the lever to use for the continuing intermittently of the front-wheel. A front-wheel is broken when making a lever "切".

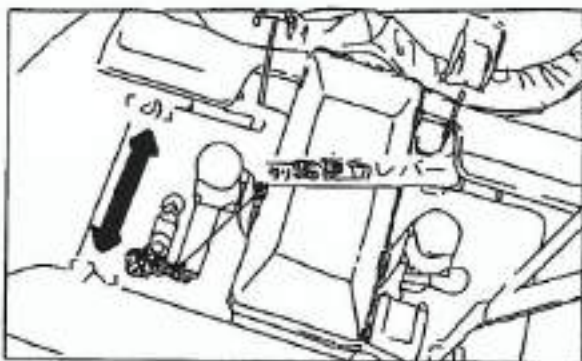

■ The sheet (1) To be operated in the easy posture according to the size of the body, the pin hole can be controlled to 3 steps back and forth by moving it.

(2) When rainy, when laying a sheet before beforehand, there is not wet anxiety.

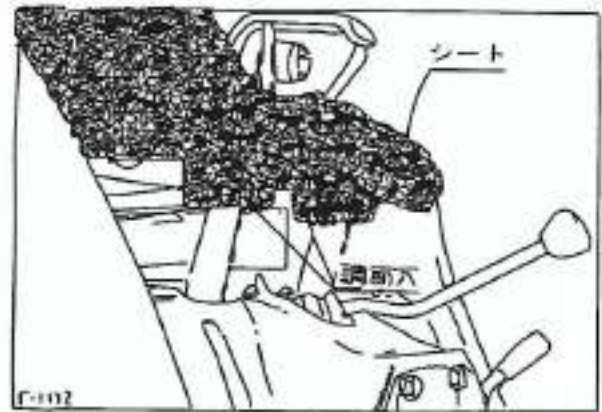

■ The rear mirror

Adjust to the position where rear view can be sufficiently confirmed.

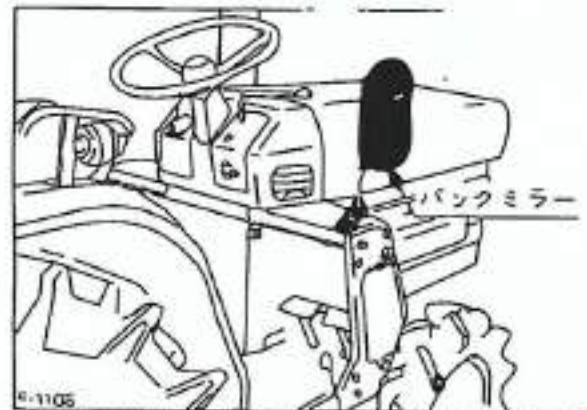

■ Tow Hitch (The optional part)

The tow do only the implementation which is adopted for this tractor in the boiling.

When towing the other one, always consult a purchase shop.

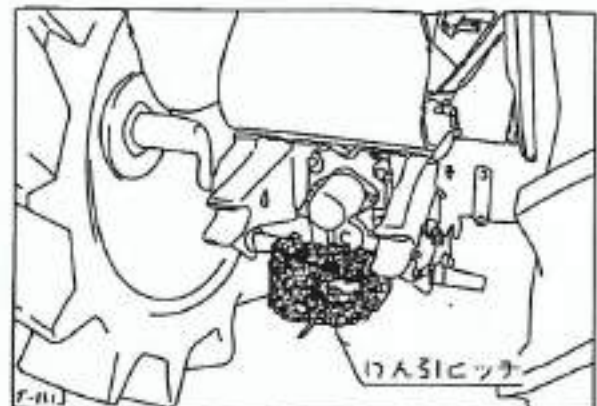

◎The safe point

● When working in the tow, always use tow Hitch and make not pull him in the top link mounting base.

There is fear which causes a life accident by the tumble when neglecting it.

■PTO axis cover

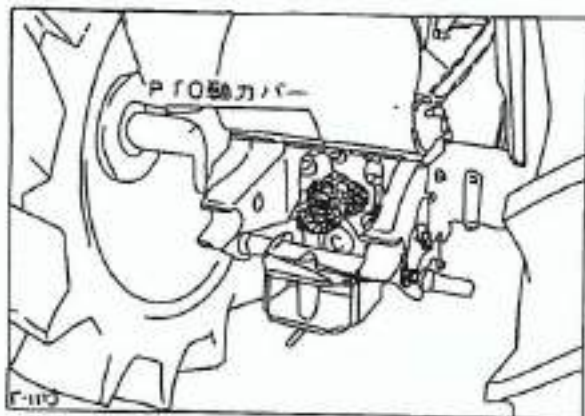

Safety Points

● When not using PTO axis, after applying grease to the PTO axis, install a cover beforehand.

There is fear which causes the life accident which depends to be caught when neglecting.

The handling of the implement

The hydraulic system always operates while the engine turns.

Also, it operates irrespective of the continuing intermittently of the clutch.

■ The control lever

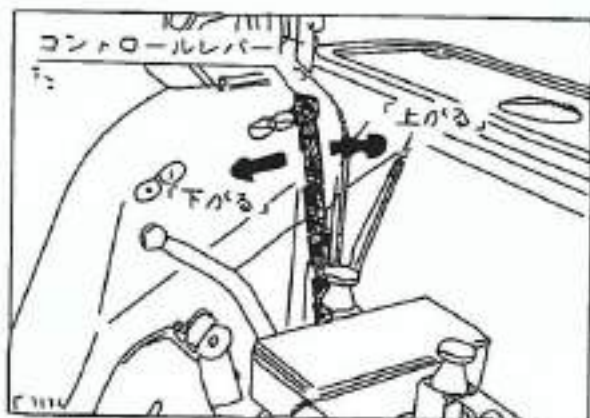

The implement rises when pulling a lever back with the equipment to make an implement go freely up and down with the control stalk. The implement descends when laying in front of the lever.

■ The control of the implement rate of descent. The fall adjusting-lever can be controlled by turning it.

Fall Adjust Lever	Descent Rate
Turn to the right	Slow
Turn to the left	Fast

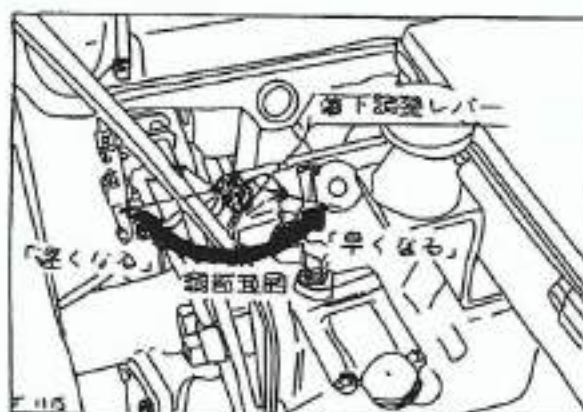

■ The chain for the safety-catch

When doing a rotary part in the inspection and maintenance, gradually the rotary part sometimes falls when raising a rotary part and running.

Always, it boils a rotary part up to the full, lower a rotary part to the position where the hook, the chain set up a chain to the chain pula blanket and use it.

When undoing the chain from chain Brackett, always hang on the tick metal fittings.

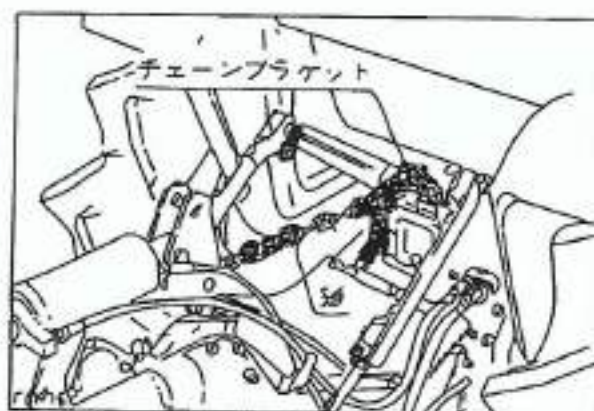

【 Note 】 ● So as not for the end of the chain to insert between the operation part, hitch to the position of the figure above right.

■ The way of installing of three links

- Remove rotary equipment.

(Page 19 reference)

- It installs a reinforcement plate in the screw part in the defense gear case lower part with three bolts.

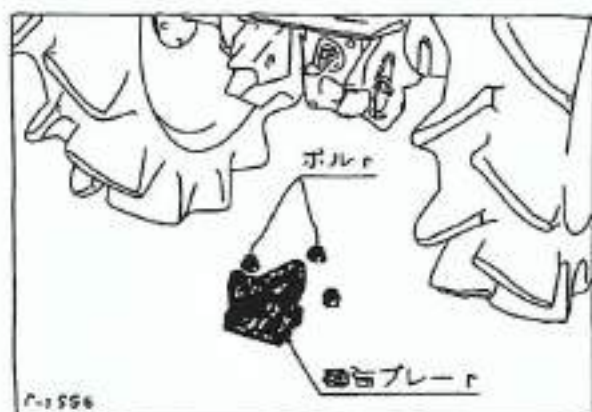

- It inserts a lower link fulcrum pin in the reinforcement plate like the figure and it fixes a position with the set bolt.

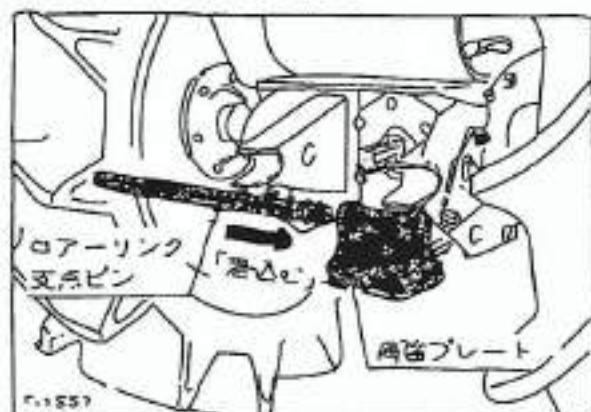

- It removes two bolts which are fastening up chain Brackett, and it replaces top link Brackett's installation with the long bolt, it gives it a lift on chain Brackett and it tightens up together.

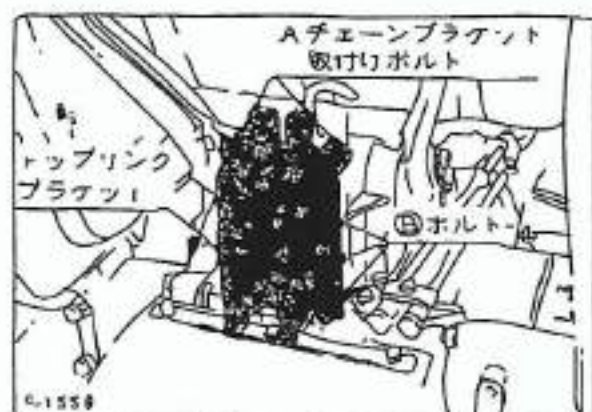

- The way of installing

It tacks earlier with two bolts of M10 in the hole of A and it puts a total to the B hole next with six bolts of M10. Surely put two pieces of Porto who tacked after that with the total.

- It inserts lower link either side in the lower link fulcrum pin and it does a coming-off stop with the link retention pin.
- It installs chain Brackett in the axle case.
- It installs a check chain in the check chain pula blanket.

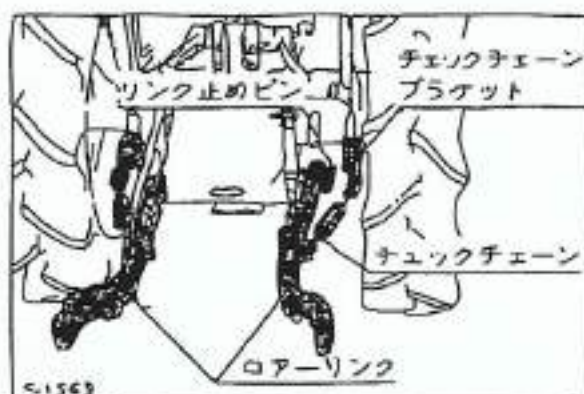

- It installs a link pin in the going-up and down arm.

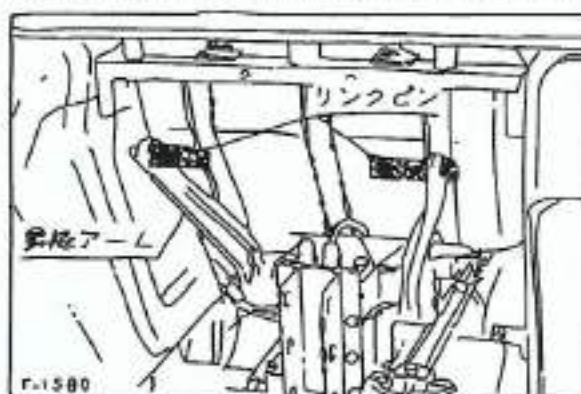

- It installs the lift rod right (the side which has a handle) in the lower link right and the going-up and down arm right and it installs the lift rod left in the lower link left and the going-up and down arm left respectively with the pin.

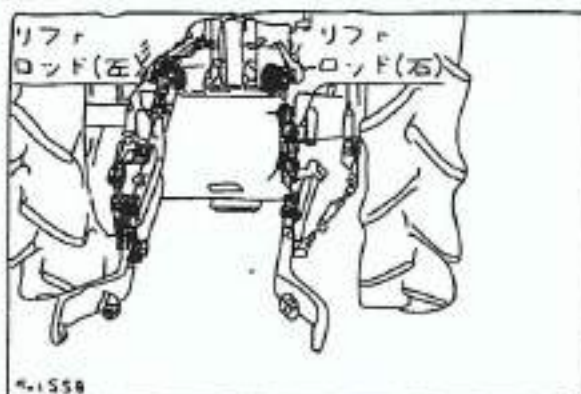

- It installs a top link with the top link installation pin.

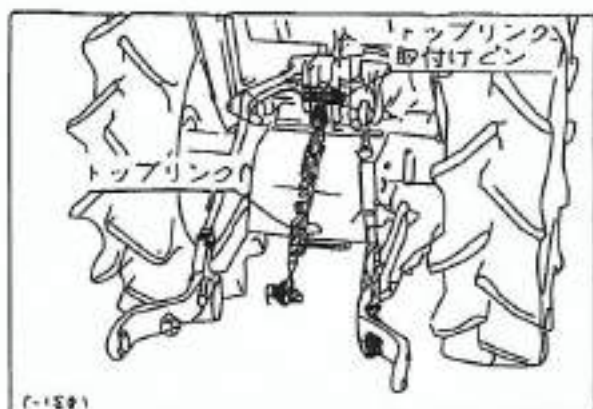

(Note) ● The installation of the top link standardize on a B hole and use A hole by need.

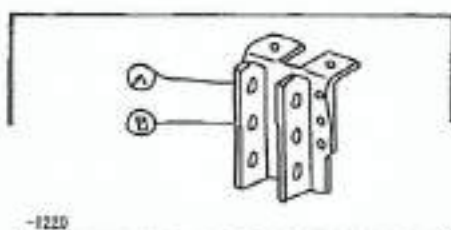

- It installs a chain.

When doing the check and the service of the implement, the implement make not fall, hitching a chain.



- Note when not installing an implement
When not installing an implement, be careful so as not for the lower link to hit a rear wheel. Do a movement stop to either side beforehand for its purpose.

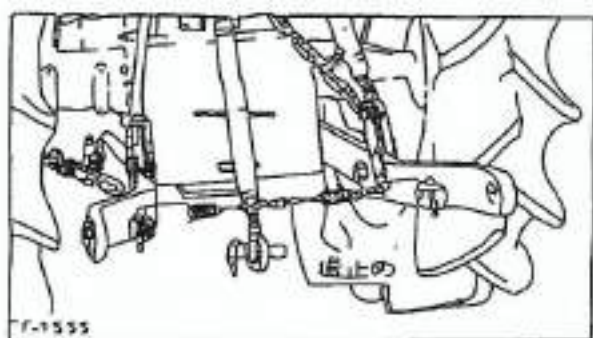

- The adjustment of the top link

- (1) Make be elastic and adjust the inclination of the implement.
- (2) The top link mounting point depends on the kind of the implement.

Safety Points

- Confirm for the protest length of the top link stretching-screw to become always equal to or more than 1.5 cm. There is fear which causes a life accident by the fall when neglecting it.

- The adjustment of the lift rod
Command to operate the handle which is on the lift rod right and to keep to do water plain on either side of the implement.

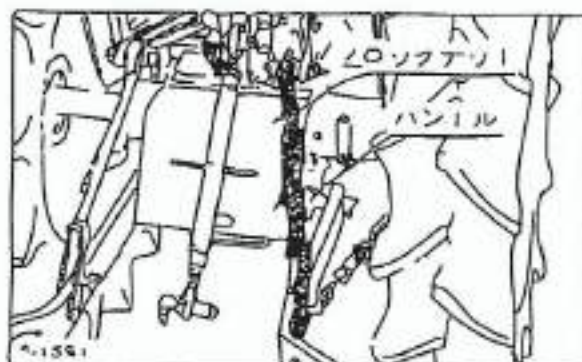

- The adjustment of the check chain
Turn a turnbuckle and limit that the prosperous of the implement which is transversal is done.

Implement	tension condition of the chain
Plow, Harrow, Sub-Soiler, Digger	loosens (The degree that the implement moves by 5 - 6 cm to the crosswise direction).
Rotary, Moer, Header, Cultivator	tightens up lightly

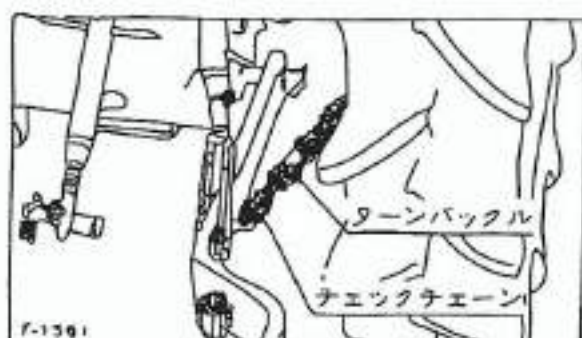

The way of the good operation

About the start of the engine

■ The manner of the start

- It makes a fuel cock "ON".

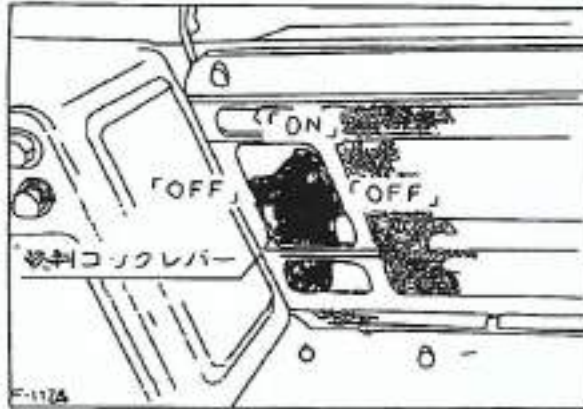

- It makes a gear lever and PTO gear lever "neutral".

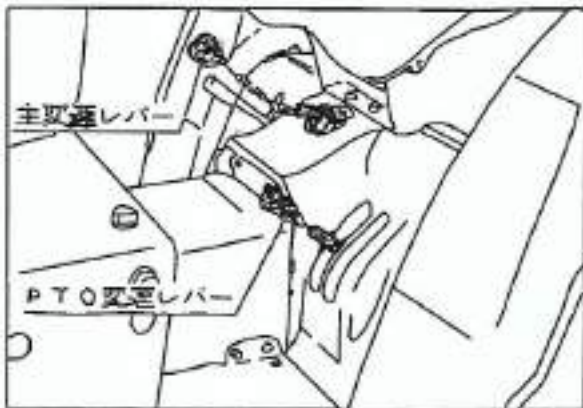

- It lays in front of the control stalk and it lowers an implement.

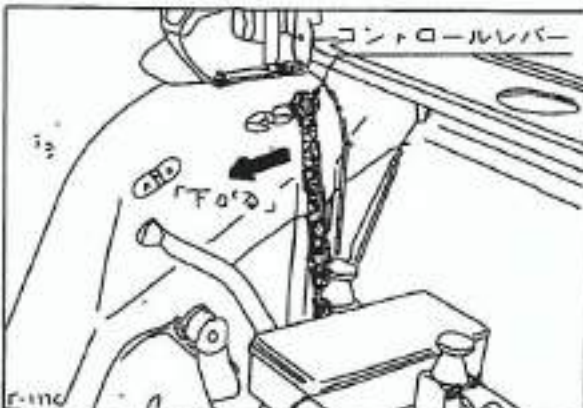

- It pulls a hand accelerator lever to the halfway.

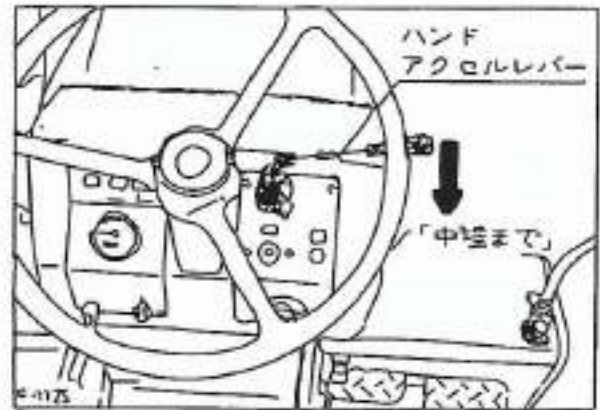

- It inserts a key in the battery switch and it turns it to the preheating position. In the season of the spring, the summer and the autumn, for about 15 seconds, it preheats a pre-heat-time for about 30 seconds in preheating, the winter. But, when an engine is already warmed up, this operation isn't necessary.

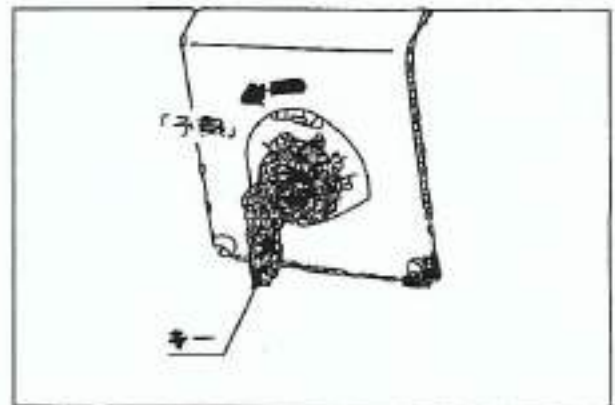

- It steps in the clutch pedal.

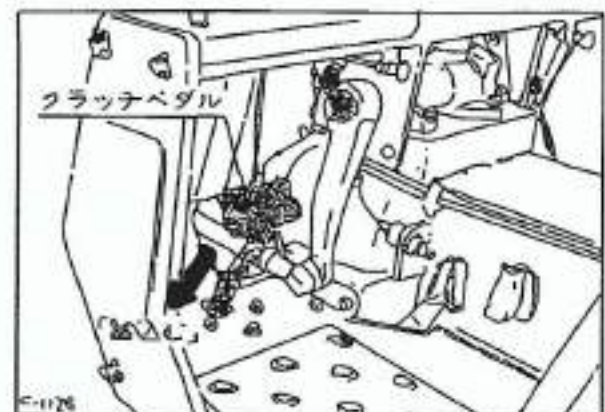

【 Note 】 ● In the clutch pedal, when not stepping to the full, the cutout switch operates and the engine doesn't start.

- It turns the key of the battery switch to the "始動" position.

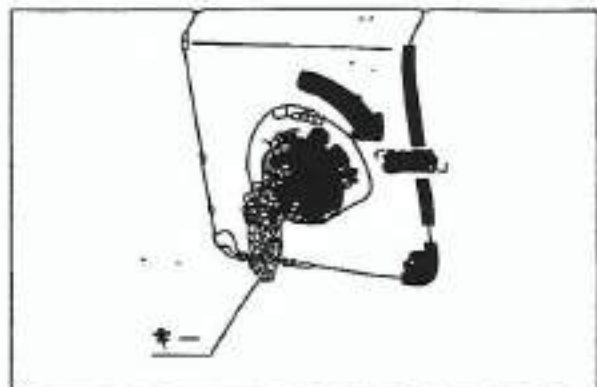

【 Note 】

● Because the starter consumes a heavy-current, avoid a continuous running duty in equal to or more than 10 seconds. When not started within 10 seconds, it cuts a switch of. once and you repeat the same operation after pausing for equal to or more than 30 seconds.

● If the engine starts, separate a hand from the key. It returns to "◎" automatically.

【 Note 】

● While the engine turns, don't make a key a start position.

● Let's operate a leg slowly by the warming-up in about 5 minutes from the clutch pedal, to do just as it is of letting go.

【 Note 】

● While the engine turns, never remove a battery cord.

■ Operate the poor charge state of the battery or the manner preceding clause of the start at the time of the cold season cold sake.

● It pulls and it decompresses a Decompress control.

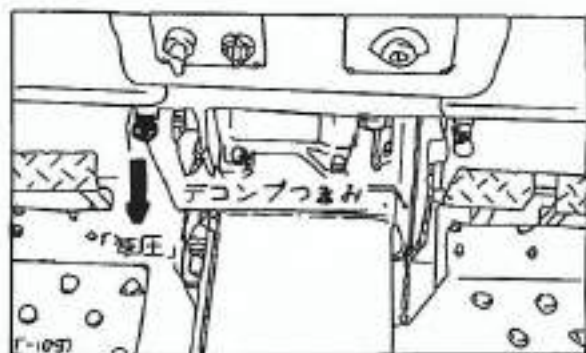

● It steps in the clutch pedal.

● If the engine begins to turn forcefully, push a Decompress control to the full.

The burglar quantity becomes in the compression leakage boiling when little and the engine output declines.

About the stop of the engine

■ The manner of the stop

● It pushes a hand accelerator lever in front of the fullness and it makes it an idling condition.

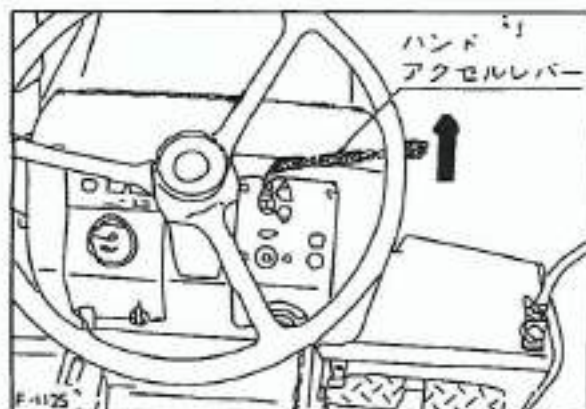

● When pulling "Engine Stop" control to the full, the engine stops.

Pushing a stop control at once after stop (Prepare for the following start.)

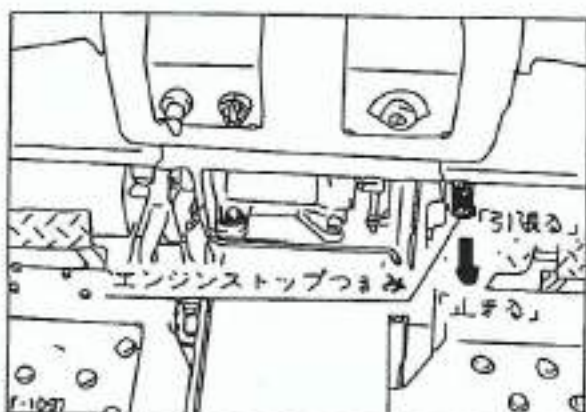

【 Note 】

● Let's make a Decompress control stop with the hand accelerator lever and the "Engine Stop" control without using it when stopping an engine.

● After making a key "◎" position, always let's pull out a key.

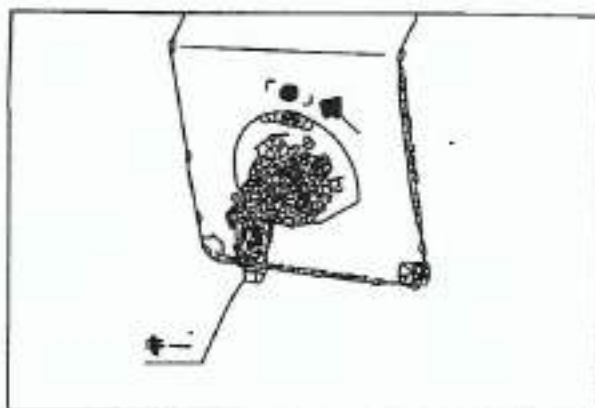

The average operation (The about 60 first hours)

During this period, observe especially the following strictly.

- (1) Abstain from the steep start, the slamming on the brakes.
- (2) Let's make not spend the speed and the load which is more than necessary.
- (3) The operation let's make do after the engine warms up sufficiently.
- (4) Slow down and let's run slowly in the bad road and the sloping ground.

About the warm-up

After start, about 5 minutes do a warm-up without spending a load. It is to make oil prevail in each engine part sufficiently. Be careful because it causes the trouble such as the seizure and the damaging in the operation part when spending a load at once after starting.

[Note] ● During warm-up, let's always use a parking brake.

Manner of the starting and the running

- Confirm that "Brake Pedal" is connected on either side.

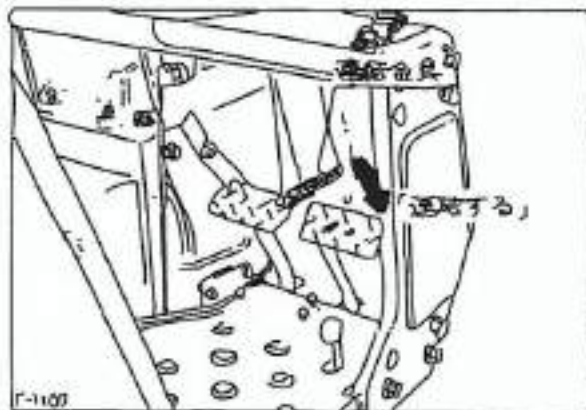

- It makes an engine turn an intermediate-speed turn from the idling.

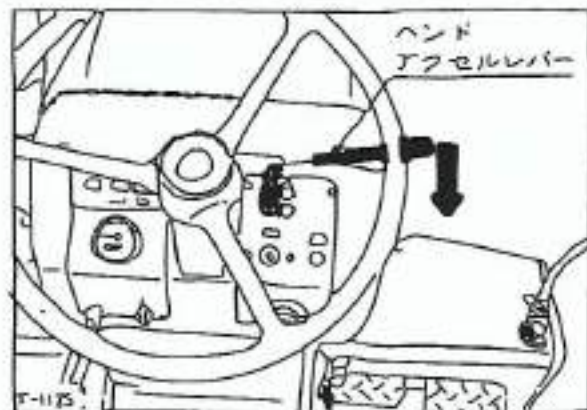

- In the control stalk, it raises "pulling back" implement and it hangs a chain on the chain pula blanket.

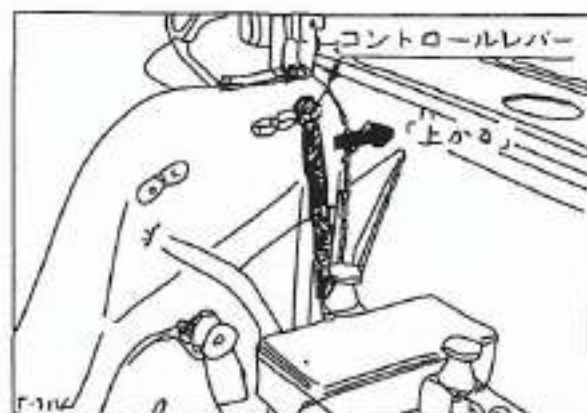

- The fullness and it steps in the clutch pedal.

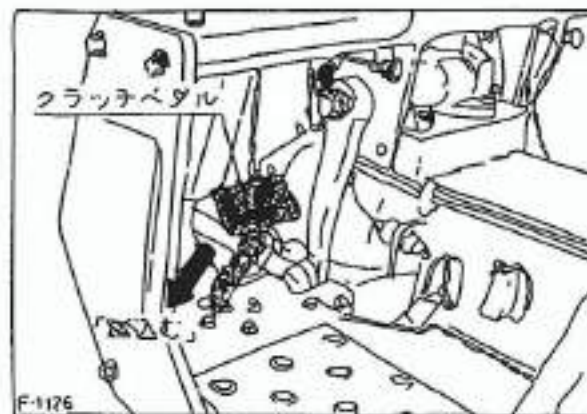

- It puts in the position to hope for the master and deputy gear lever (and, are a Creap gear lever).



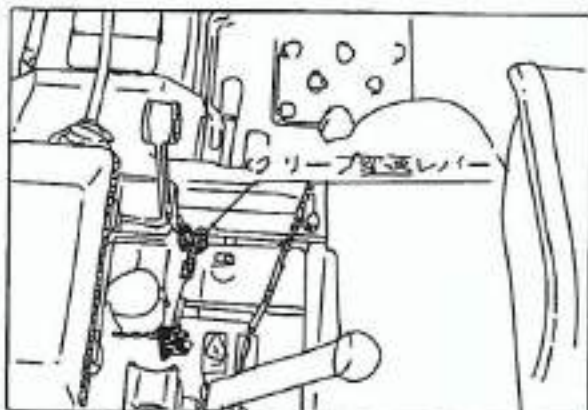
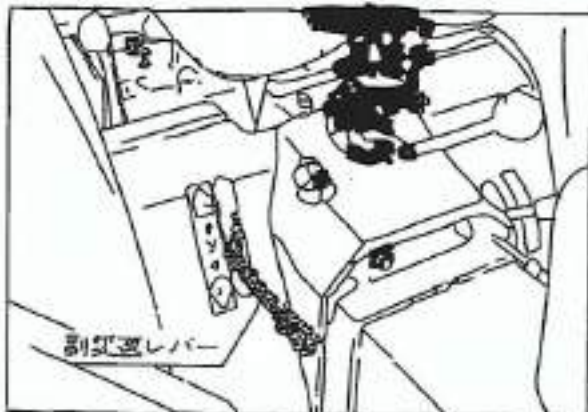

【 Note 】

- The gears can not be changed to the moving. Always, do a clutch pedal of. of making stop after stepping in the tractor.
- If letting a clutch pedal go slowly, the tractor begins to run.

【 Note 】

- (1) The moving let's make not load a leg on the clutch pedal. The abrasion becomes early in the condition which the clutch fails when carrying a leg.
- (2) Early when cutting the operation of the clutch pedal, when connecting, operate it slowly.

Safety Points

- Before moving a tractor, be careful of back and forth either side. It sometimes causes a life accident when neglecting it.

The manner of the stop

- It presses in front of the hand accelerator lever and it makes Engine turn an idling condition.
- It steps in the clutch and the brake pedal.
- After stopping fully, it makes a main gear lever " neutral ".
- When installing an implement, it lowers " laying in front " implement slowly in the control stalk.
- Lock a parking brake surely.

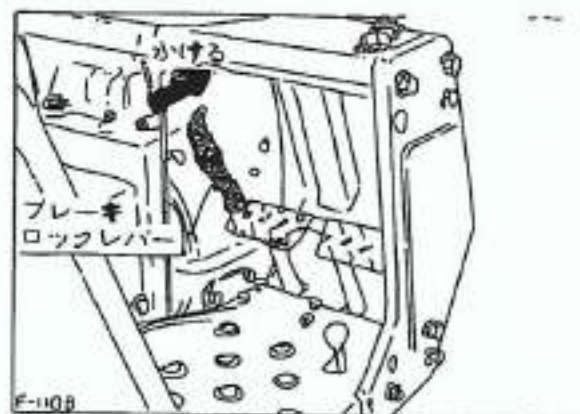

- It stops an engine with the engine-stop control.

【 Note 】

- When stopping a tractor beforehand on the way on the hill, let's always do a car stop beforehand to the tire.

About Rotary Tiller

The way of removing rotary tiller

When installing rotary equipment, there is residual pressure in the hydraulic hose and it is sometimes difficult to install a hydraulic hose.

Remove rotary equipment by the following procedure.

- It removes a chain for the rotary equipment safety-catch from chain Brackett.
 - It makes rotary equipment rise to the full.
 - It makes a depth of plowing control lever the deeper one.
 - It stops an engine.
 - It makes a depth of plowing control lever the shallower one.
- (It makes fall prudent to 0-5 of the cylinder graduation).
- It grounds rotary equipment with the control stalk.
 - It misses the hydraulic hose of the tillage depth control.

The hose comes when pushing the outer-tube of the joint.

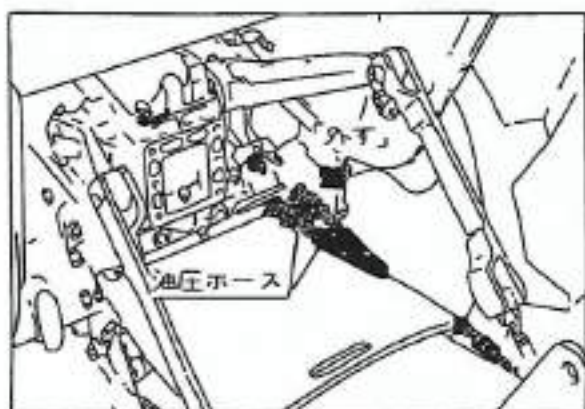

- It pulls out a veda pin and it pulls out two link pins.

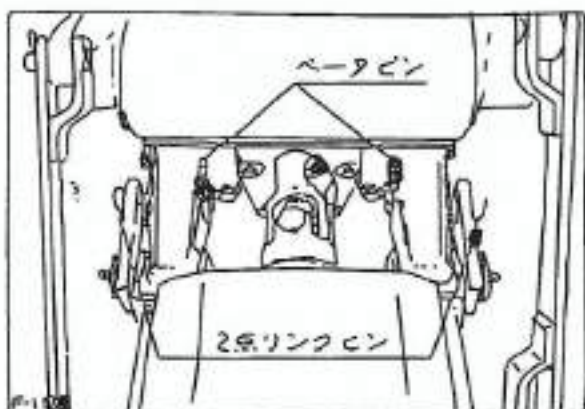

- It suppresses a joint stopper and it pulls out a joint to the side of the rotary.



- It pulls out a head-attached pin of the beta on going-up and down arm either side tightly.

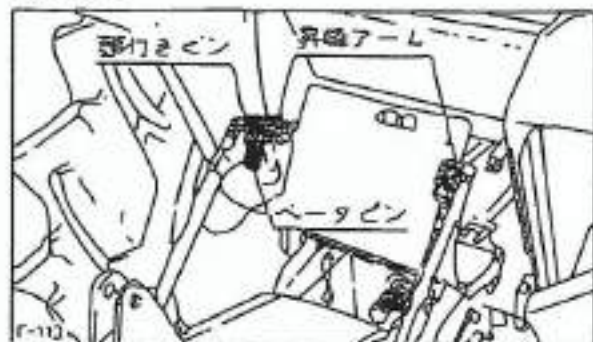

- The rotary equipment comes when having and pulling the cover of the rotary equipment quietly back.

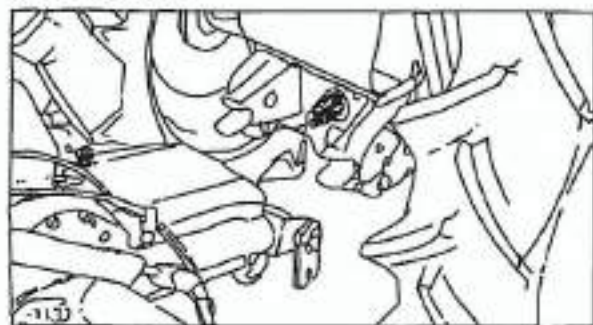

- After removing rotary equipment, install a cover in the PTO axis.



The way of installing rotary

It chooses the flat place at the floor and it is possible to do it in the way which is opposite to the removal but it can be installed in pipe single using the hydraulic pressure, too.

● Until the installation point of the rotary equipment contacts the installation point of the tractor, it is possible to mean a tractor by the sternway.

● It adjusts the fulcrum pin of the rotary frame to the U metal fitting part of two link pula blankets.



● With the control stalk, it lowers a going-up and down arm to the full and it connects a going-up and down arm and a rotary lift on either side head-attached tightly with the beta pin.



● When the connection ends, it lifts a rotary part by about 10 cm with the control stalk and it boils connection plate each other in the connecting pin hole and it stops a connecting pin with the insertion, beta pin.



● It inserts a joint in the side of the rotary to the full, it suppresses and it sets a joint stopper in the PTO axis.

【 Note 】

- (1) When it is difficult for Joint Stopper to operate, it moves lightly when oiling.
- (2) Confirm whether or not the joint stopper telescopes into the gap of the axis surely.



● It connects the hydraulic hose of the tillage depth control. 【 Note 】 (1) Because it is dividing into the gold and the black, connect with the joint with the same color. Be careful because the direction of the operation of the depth of plowing control lever becomes opposite when the connection of the hose becomes opposite. (2) It pushes the turnip (joint) of the hydraulic hose into the nipple (the joint) on the side of the tractor and it connects it.

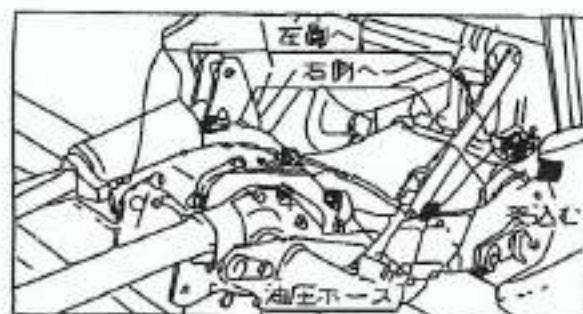

- (3) It be possible to do, that it is easy to connect between the nipple (the side of the tractor) and the coupler (the side of the rotary) with one hand but when it is difficult, don't do by force. (Damaging an O-ring and causing the oil leakage when doing by force)
- (4) When the connection is solid, it is lightly made when connecting after making a tillage depth control lever operate by the top and the bottom.



● Ascertain a rotary equipment-item and hitch a chain to the suitable position.

The way of installing the tiller tines of side drive [RS type]

● In case of Flat Tilling

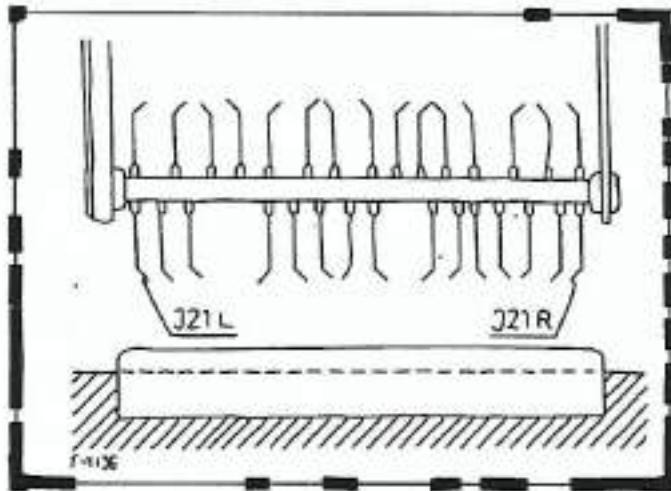

● It flat breaking yeah destroys in the ridge

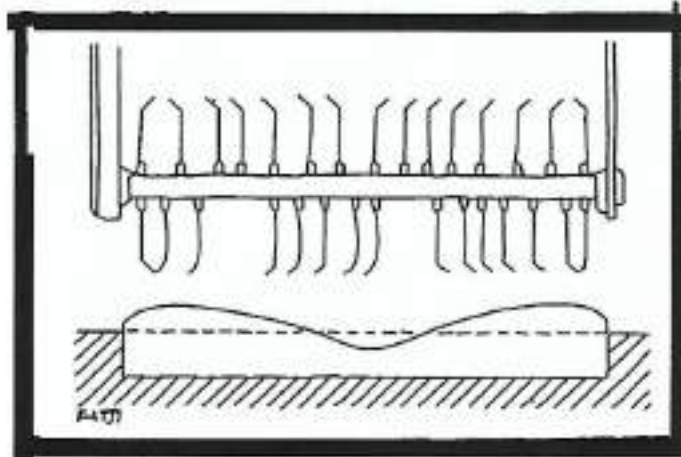

■ When doing by the inside flower

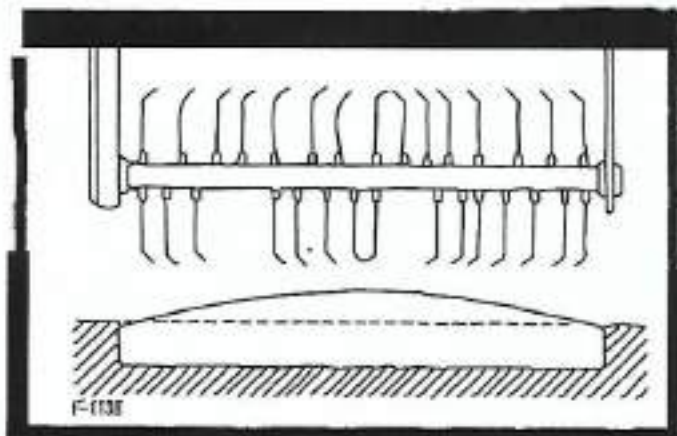

The way of installing Tiller Tines of Side Drive (RK type)

he full-cut method is providing an inclination nail axis.

The tilling nail inclines in the chain case lower part and gets to type and balance tilling generates no kind of ground.

In case of Flat Tilling

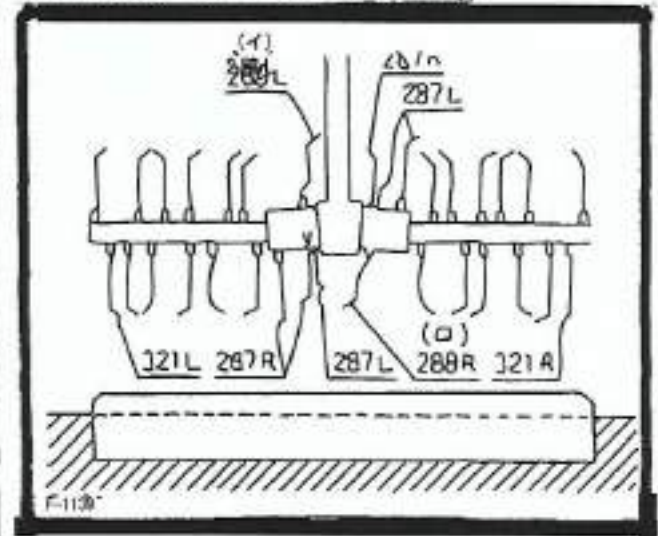

● It flat breaking yeah destroys in the ridge

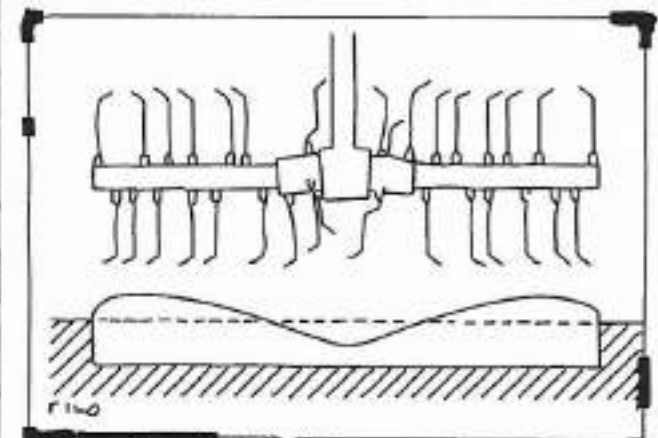

■ When doing by the inside flower

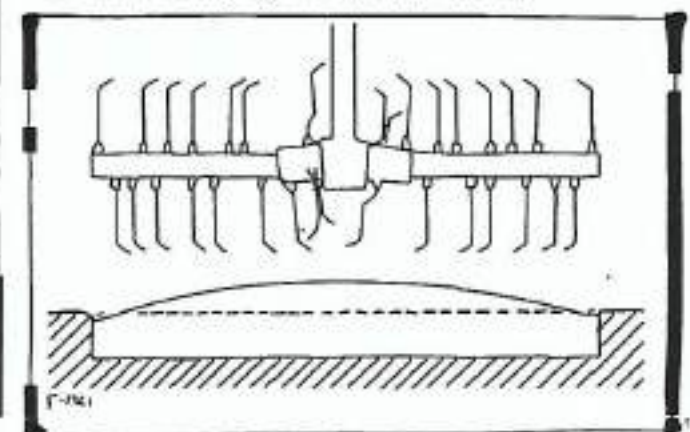



Note

● When installing a nail axis component in chain case (新爪軸ブラケット) mounting bolt in chain case (爪軸ピン) to the side of the coming 3Pcs. of each of the top sidedness nail shaft brackets after Brackett becomes right above, install from inside like the figure.

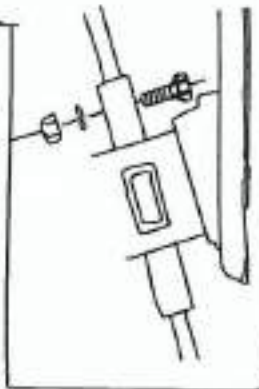

The way of attaching or removing nail axis component [the side drive RS type]

◆ The way of removing

- It removes a head-attached pin coming-off stop nail on the nail axis side (the left side) of the rotary case.
- It pulls out a cotter pin and it takes out a nail ring pin.

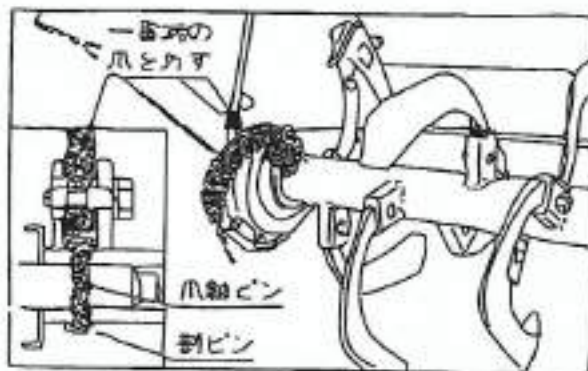

- It removes three bolts which are combining a side frame with the nail axis holder.

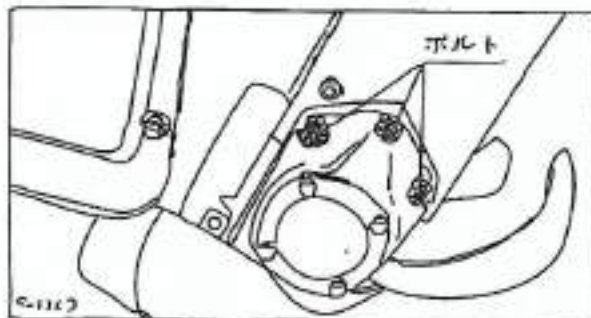

- It turns a nail axis holder in the right end 180°.
- It turns a nail axis and it looks for the position where the tilling nail doesn't touch a side frame.

- It makes a nail axis move to the right and it solves the combination of the spline part of the nail axis and the nail line shaft.

◆ The way of installing

Do the installation of nail axis component by above-mentioned opposite order.

The after handling of the 2 ring equipment

■ The control of the depth of plowing

Do tilling depth of the various work with the depth of plowing control lever.



Safety Points

- While the depth of plowing adjustment makes a tractor move forward, avoid an adjustment from the state of the side of the fuselage absolutely.

It sometimes causes a life accident when neglecting it.

■ The instruction of the depth of plowing

The position of the depth of plowing pointer of the cylinder shows a tilling depth. When the figure becomes big, the tilling depth becomes deep.

<Note>

- The tilling depth isn't constant with the condition of each land. The figure of the label has been written as the standard with tilling depth. Learn the position of the pointer in that it is possible to decide that case and for the pointer to be always there during tilling, the tilling depth of the land of the customer control with the control lever.

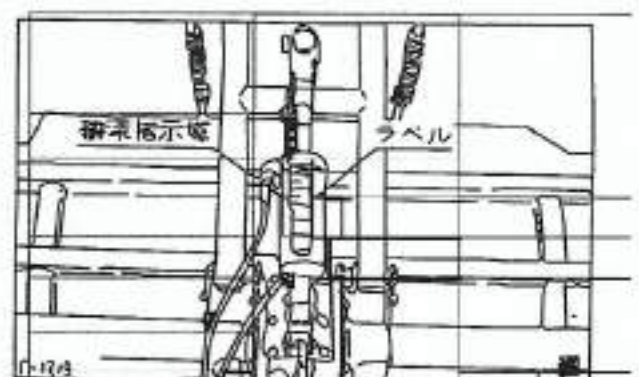

■ The after adjustment with the 2 ring support Use follows according to each work. Rear 2 rings go up and down when they remove a beta pin and pull out a head-attached pin.

(1) Raise rear 2 ring support in case of general tilling and control it.

(2) In case of plowing and irrigating the fields and paddy field tilling, lower a 2 ring support later and use it.

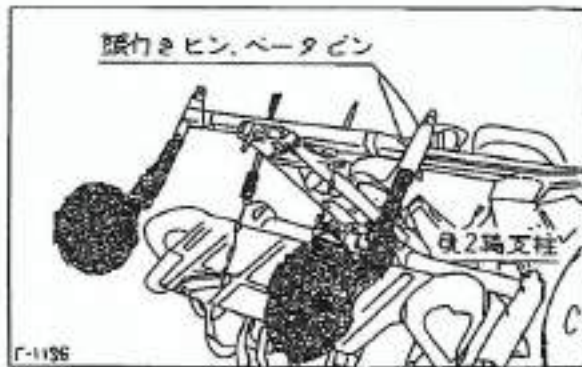

■ The after adjustment by the Rear 2 ring fulcrum pin, as for the 2 ring equipment, installed height is changed by the replacement of the pin according to the dry rice field and the paddy field. In case of paddy field tilling, install in the underside of the frame and in case of dry rice field tilling, install in the upper side. When installing in the underside, the 2 ring support left and the right, too, change installation later.

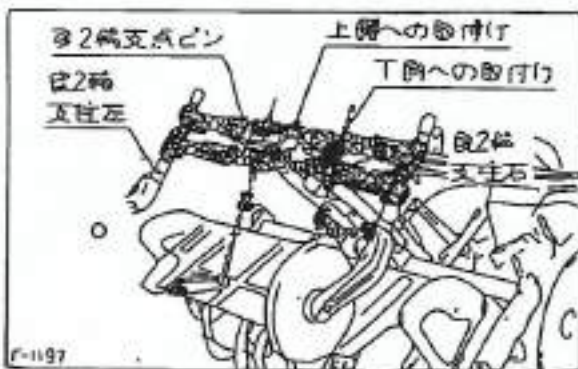

The control of the rear cover

Cultivate work with the rear cover exchange, command and use the position of the insertion hole of the snap pin in the rod underside for necessary cultivate pressure. If making a hole above, cultivate pressure becomes strong and becomes weak if making a hole below. Control the length of the rod with the snap pin in the rod upper side.

Moreover, when cheering up a rear cover from the ground and working, move the spring of the underside to the upper side of the 2 ring support later and use it again with the spring of the upper side.

【 Note 】 ● Be careful because the spring gets to stick when operating a depth of plowing control lever to the "shallow" direction in the condition to have lifted a rotary, and the rod props up and there is fear which damages a cover when continuing operation still more after sticking, too. (When inserting in the pin hole on 5 holes from below and being used)

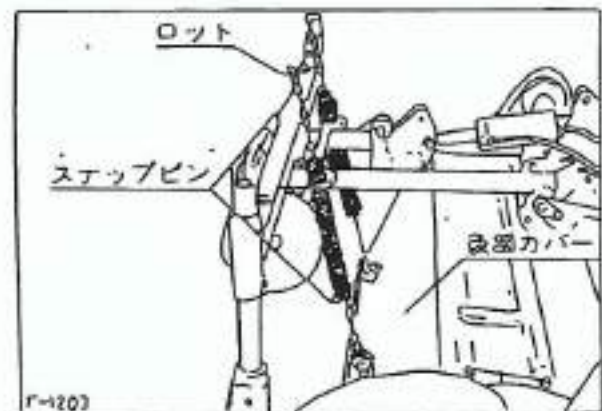

Way of rotary tilling

■ The way of the neighbor tilling

When the condition of the cultivated land is good, the neighbor tilling is efficient and the work, too, is simple.

● It makes a nose wheel and rear wheel tire the modes test.

● The speed makes a nail turn 1 - 3 paragraphs in 1 - 2 speed and begins tilling by the point like the figure.

● It leaves the neighborhood of the cultivated land by about 2.6 m and it does tilling around three times after going-straight on tilling.

● It operates the tilling order while careful so as not to proceed with it, to be next to each other and to fall to the place where the front and the rear ring tire tilled sometime.

● The side of the side frame boils a side drive rotary (the RS form) in footpath between rice paddies edge, and makes it become and tills in footpath between rice paddies edge.

◆ The order of the neighbor tilling

Forward direction of movement
It backs ←..... once.

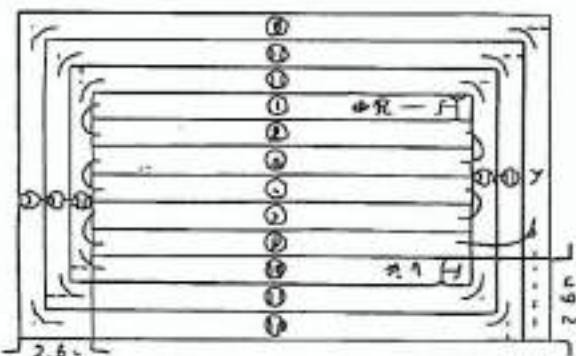

(1) One sheet of rectangular parts of the figure show the cultivated land which is tilled by once of going-straight on.

(2) It is the way of the best not to step on the place to have tilled sometime with the rear wheel tire that catches an order like the figure.

(3) Therefore, the starting point is decided by the place which the tractor leaves outside at last.

(4) It always raises. Rotary until the going-straight on ends and moves to the following going-straight on and it turns over.

■ The 1 ridge placing tilling method

As for this way, by the point which is the same as the conventional farm tractor, because it is simple, handling, too, is often used.

● It opens the neighborhood of the cultivated land by about 2.6 m and it begins tilling.

● First, after going straight on - boiling in the storehouse placing and being tillered, it wakes up the remainder in tilling and it completes it last in three times of tilling around.

● As for the width to leave in the placing boiling of 1 loss, the ones which are fewer somewhat than the facies medialis of the tire are completed in the beauty in the small loss in balance tilling.

Also, the rear wheel top of the centerline about the nosewheel or if controlling appulse outside, the work is easy.

◆The 1 ridge placing tilling method

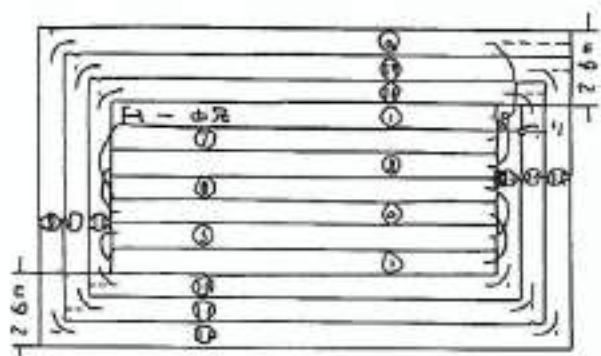

(1) The 1 ridge placing tilling is the way of using when the sharp turn is difficult.

The others are the same as the neighbor tilling.

(2) In the figure, a turn by the back is shown but the direction can be changed by turning, too.

■ The turn of the tractor

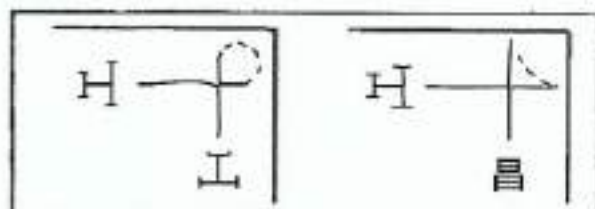

The rotary ridge standing work

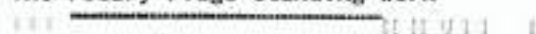

■ The way of installing a ridge standing receptacle

It inserts a ridge standing receptacle from under the mounting bracket hole, and change installed height according to the working state and install it with the bolt. (The ridge standing receptacle and the bolt are an option attachment part).

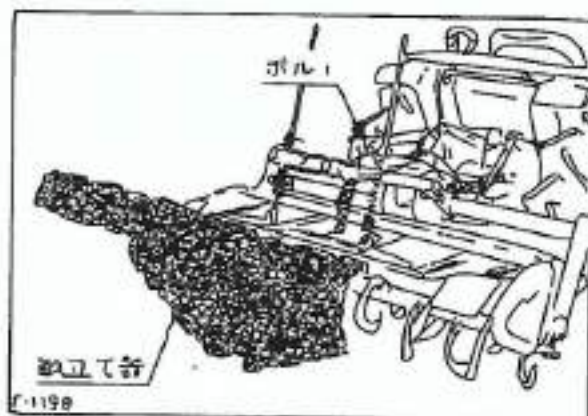

(1) There is an arrangement of the nail for the outside. (2) It installs depth of plowing control check metal fittings.

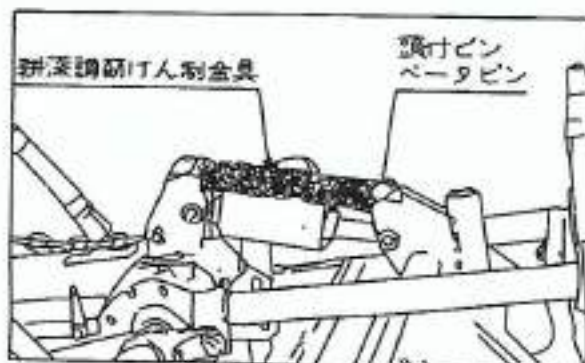

(3) It moves the ridge standing axis cover of the rear cover by 90 degrees.

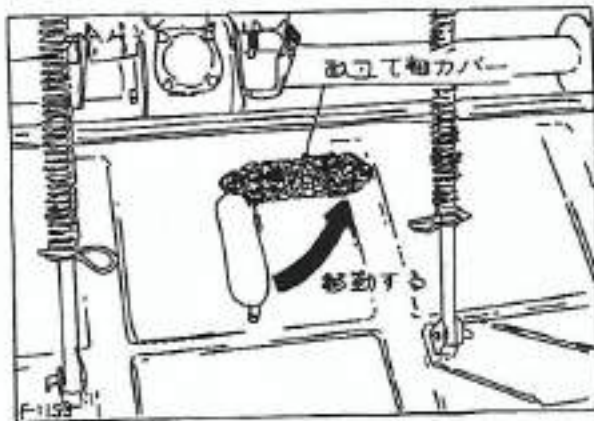

(4) It removes a rear 2 ring.

■ The work method

◆ The prudence ridge standing law (The 1 ridge placing ridge standing law)

This way is the most efficient but like the 1 ridge placing surface tilling ridge standing law, ridge width is limited by the tilling latitude.

- Installing a ridge standing receptacle
- It tills in the 1 ridge placing.

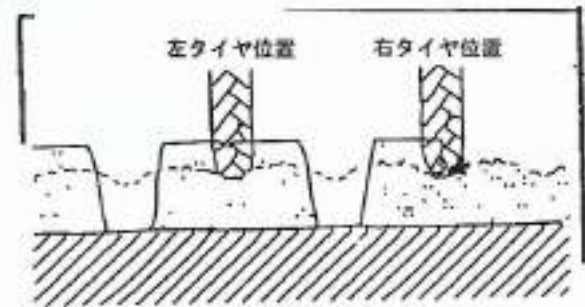
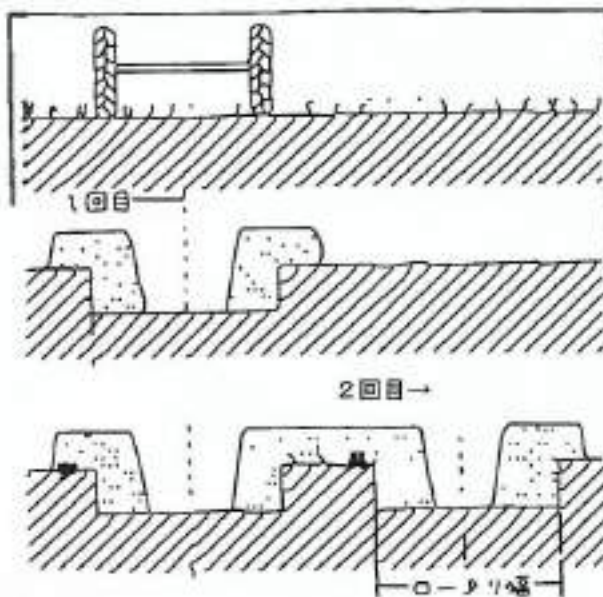

◆ The way of standing a heartless ridge (Way of standing a 1 ridge placing surface tilling ridge) This way is efficient compared with the way of standing a ridge after surface tilling. However, ridge width is limited by the tilling latitude.

- Almost, when deciding ridge width, it tills in the placing boiling of 1 ridge.
- It is possible to stand on the ridge while installing a ridge standing receptacle and tilling

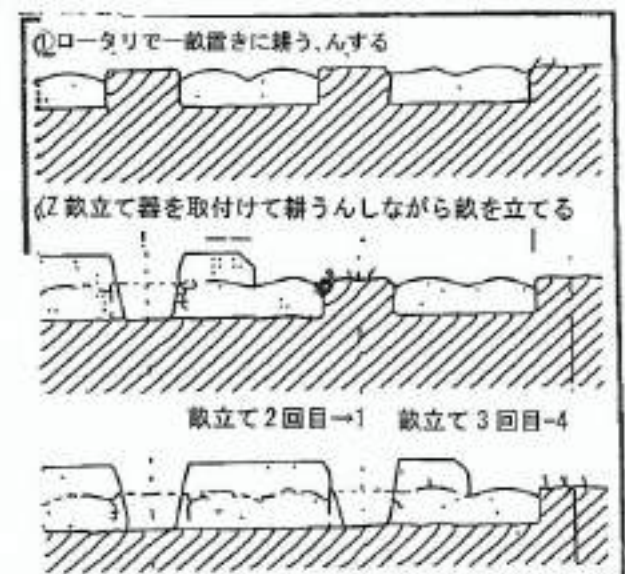

Things above mentioned are an example only. Because the condition depends on the district, think of the way of fitting a land condition.

[Note]

- Be careful because it becomes the cause which bends a nail and damages 2 rings and a chain case later in case of being as the tilling condition and turning over by turning the steering wheel by force.

◆ The ridge standing law after surface tilling

This way can choose ridge width freely and can do the ridge to be uniform and for clod to be thin, too.

- Almost, it is possible to leave a ridge standing receptacle on the ridge by installing it after tilling in the surface in the rotary and it works.

It is beautifully completed when it is possible to stand on the ridge after putting a nail in this case once more for the outside after doing all of the fields which

- The check of the mounting bolt of the exchange of the nail and the nail and so on begin work after of safety purpose, always stopping an engine by it, hanging a chain for the rotary equipment safety-catch and preventing from a fall by it.

Note of the handling in the farm———

When working at the farm, the work method depends on the shape, farm, the paddy field and the field of the crop and the tillage and so on. To make show the performance of the tractor sufficiently, study a work method according to the farm and work efficiently.

- (1) When attaching an implement to the rear, the weight which is taken for the nosewheel changes and it becomes easy for the nosewheel to rise.

When putting a clutch, make separate a leg from the clutch pedal quietly.

- (2) The going in and out of to a farm be careful of the following matters.

- Use a slope board or make the inclination of the footpath between rice paddies small because the rear wheel floats in addition to that it is possible to use the rotary part in the footpath between rice paddies boiling it and damaging a rotary part by it and passes away, that it is possible to move it when the case, difference-of-elevation to fall at the farm from the footpath between rice paddies is big.

- When rising from the farm to the footpath between rice fields, use slope board.

- Doing to do the footpath between rice paddies beginning of climbing and little stopping of the it nail turn by the rotary and doing and little lowering of it below and little rising of the nose wheel occurred finishes in case of doing and moving forward. Raise a rotary part at the same time as rising to the footpath between rice fields.

- When the tire is wet with the plowing and irrigating the fields work and so on, it sometimes slips in. in a form of sloping ground.

In such a case, use a slope board as much as possible.

- It doesn't think that the farm goes in and out easily, come out beforehand every farm and let's take counter measures of the footpath between rice fields to require and so on beforehand.

- (1) Always confirm connection on either side of the brake pedal.

- (2) The going in and out of to a footpath between rice fields and a farm doesn't get off diagonally in the climbing and do, being right-angled.

- (3) The ability to finish boiling particularly increases when utilizing the characteristic of the four-wheel drive car when going up the footpath between rice paddies and rising by the back.

- (4) When entering a farm and working, to improve a rotationality, remove and make the connecting-fitting of the brake pedal the condition which the brake on either side can be separately used for.

- (5) In the tilling of a rotary (of the reference to page 9) of control rate of descent, by the rate of descent control lever of the implement, make fall slowly and in the plow and so on, be made to make fall early.

- (6) It is footpath between rice paddies edge and when turning over, it is possible to do sharp turn turning-over when cutting a raising, steering handle and stepping on the brake pedal on the side of the turning-over in the implement with the control stalk.

Safety Points

- When turning over at the end of the footpath between rice paddies, always lower speed.

It is extremely dangerous when doing a bootleg turn at high speed.

- It sometimes causes a life accident when neglecting.

- (7) The driving speed depends on different work. Decide according to the purpose of the work and the condition.

- (8) The resistance of the wheel on, either side becomes disproportionate in case of the soft place and heavy tow work and the tire in the side sometimes idles. In such a case, when working a diff-lock pedal, it prevents idling and the tractive force comes out.

- (9) Remove a draining-plug in the bell housing lower part in paddy field tilling and as it used for water to the frame by the plowing and irrigating the fields work at the time and confirm whether or not water isn't included in.

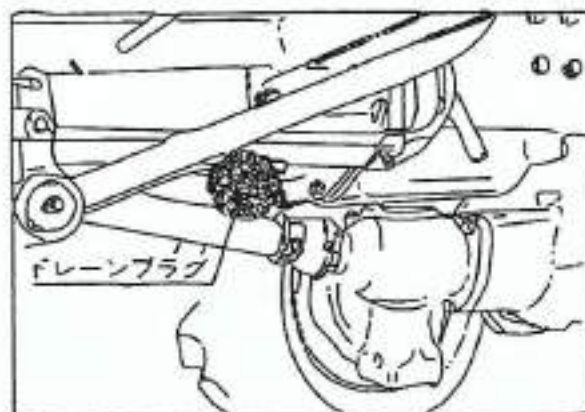

About the check before work (The beginning check)

The check part

To prevent trouble from happening, it is important to know always the condition of the machine well beforehand. The everyday check-up do without fail every day.

■ Implement a check by the following order.

(1) The abnormal part in the previous day

(2) Walking around the tractor

- The lighting-up of the lamp kind and it becomes dirty and being damaged

- The dirt, the damage of the license plate

- The air pressure, the crack, the damage, the abrasion of the tire

- The looseness of the bolt and Nut in the underside of the tire and so on

- The dirt, the damage of the antenna reflector

- The quantity of the transmission oil

- Fuel sufficiently?

- The cooling card oil leak check

- The oiling by the check rod

- The oiling by the rear 2 ring fulcrum pin

(3) Opening a bonnet

- The quantity of the engine oil

- The quantity of cooling water

- The stuff of the dust of the air cleaner

- Walking around the tension condition, the damage

(4) rotary of Juan belt

- The looseness of the nail and the nail axis mounting bolt

- The quantity of rotary case oil (The RS Type)

- The quantity of rotary case oil (The RK Type)

- The looseness of bolt Nut in each rotary part

- The confirmation of the pending-lock of the lock pin of the universal joint

(5) Sitting on the driver's seat

- The blink condition of the oil charge lamp (the warning light)

- The operation of the tractor meter

- The blink of the turn signal lamp

- The operation of the klaxon

- The reflection of the back mirror

- The play of the brake pedal

- The play of the clutch pedal

- The play and the gutter of the handle (6)

It starts an engine and it operates a test.

- The color of exhaust

- The effectiveness, one effectiveness of Brake

- It is the weight, the movement, gutter of the steering wheel.

How to Check

The air pressure of the tire

It examines whether the air pressure of the nose wheel and the rear wheel is proper.

The standard to judge from the outward appearance is as follows.

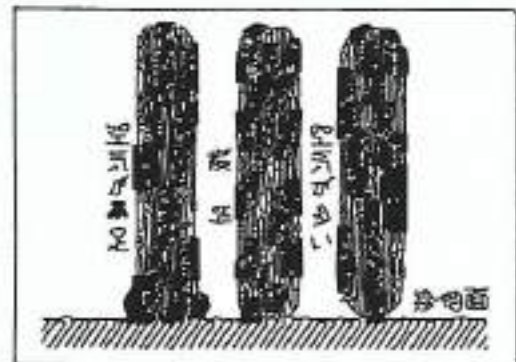

◆ Normal Air Pressure

	Air Pressure (kg/cm ²)	
	2WD	4WD
Front	2.4	1.6
Rear	1.0	

The nose wheel air pressure such as front Loader when the load hangs over the nose wheel press a style as follows.

	Air Pressure (kg/cm ²)	
	2WD	4WD
Front	3.2	2.0

[2]The quantity of the transmission oil

- It examines whether to pull out again after pulling out a bayonet gauge and wiping a tip beautifully and inserting it and whether or not there is oil among the carved seals.
- In the case below the minimum carved seal, it be necessary to replenish but don't put above the upper limit. (It is page 32 therefore to refuel)

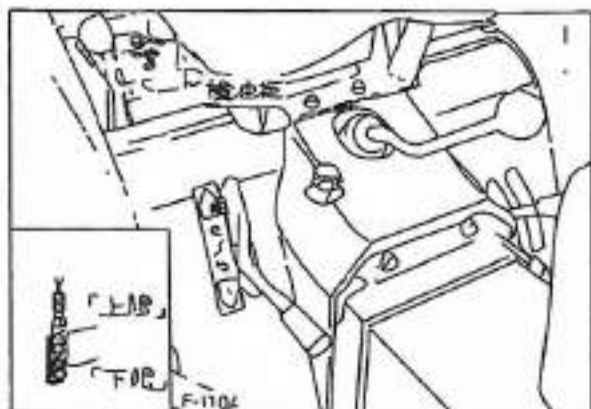

[3]Oil the oiling check rod receiving boss part and the check rod of the check rod in oil or grease.

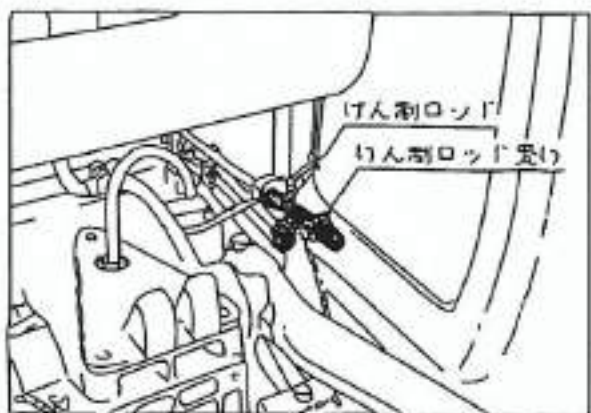

The oiling by the rear 2 ring fulcrum pin
Oil in oil or grease.

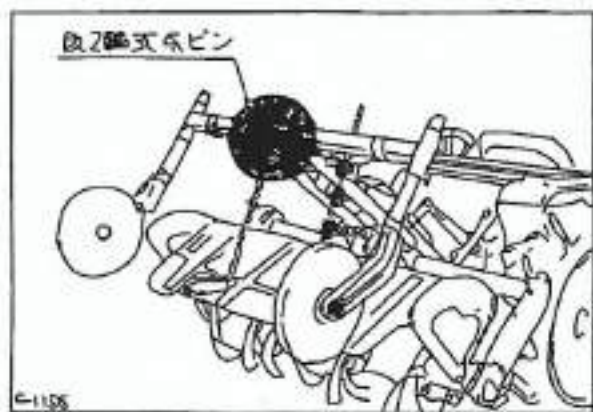

The quantity of the engine oil

- It examines whether there is oil between the pulling-out minimum and the upper limit again after pulling out an oil gauge and wiping a tip beautifully and inserting it.
- In the case below the minimum, it be necessary to replenish but don't put above the upper limit. (It is page 32 therefore to refuel)

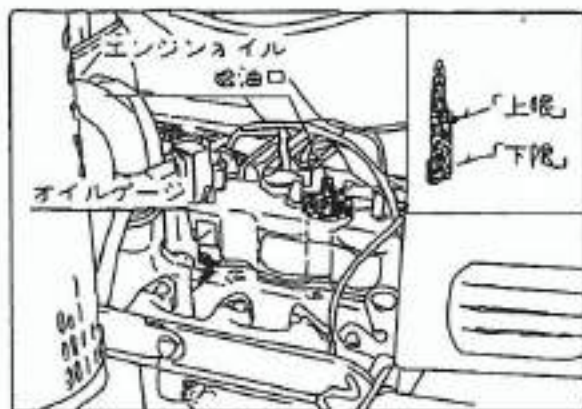

【 Note 】

(1) When checking, put a fuselage on the level place and do.

Correct quantity isn't sometimes shown when declining.

(2) Check whether or not the oil quantity is before engine starting after equal to or more than about 3 minutes after stopping an engine.

In oil, yet, it is left in each engine part and it isn't possible to measure correct oil quantity in case of meeting and not being.

6) The quantity of cooling water

The radiator has the compensating vessel and when cooling water in the radiator decreases, it becomes the structure which is automatically replenished from the Reserve tank. As for the quantity of cooling water, check quantity in Reserve Tank. It is normal if being the range of LOW from FULL. (It is page 35 therefore to water)

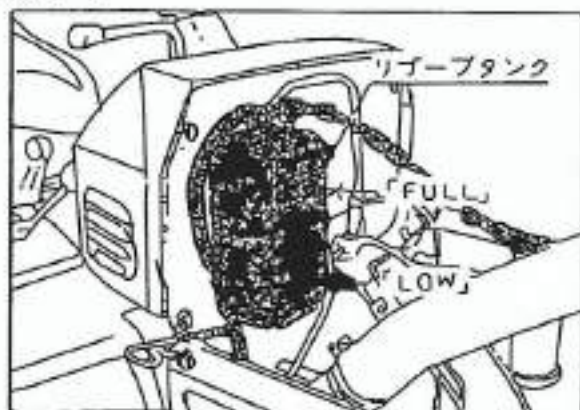

【 Note 】

● Don't open the others when the cap of the radiator main unit checks and exchanges cooling water.

(7) The stuff of the dust of the air cleaner

It hastens the abrasion of the cylinder liner and the piston ring and the air cleaner becomes output lack when it is the equipment which removes the garbage which is contained in inhalation air and dust and so on are contained in inhalation air.

(1) Confirm whether or not dust isn't collected in the cover.

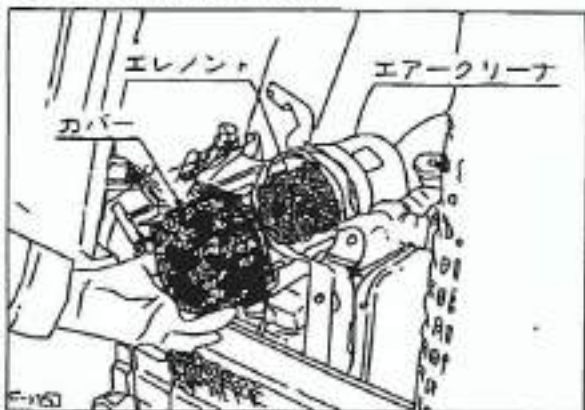

(2) Confirm whether or not garbage isn't collected at the air cleaner element.

【 Note 】

● Get the installation of the air cleaner cover for top in the cover back to look up.

When making a mistake in the grappling, Chile and the dust don't collect in the cover, and adhere to the element directly and make the lifetime of the element s. rt remarkably.

(8) The tension condition, the damage of Juan belt

When the adjustment of the belt is bad, it causes the over heat and the poor charge state. Bring under control the center of the belt with the fingertip and confirm whether or not the deflection is about 7 mm.

Also, it examines whether there are not a crack and to come off. (The adjustment is page 41)

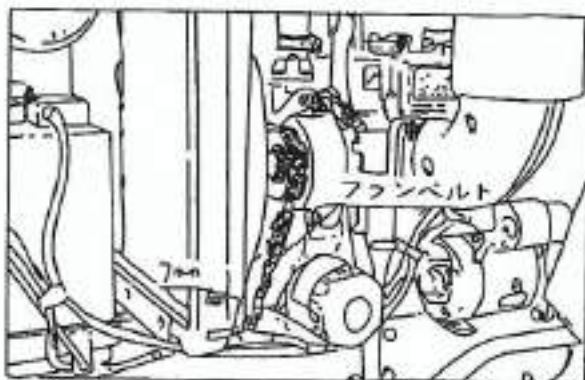

(9) The quantity of rotary case oil

【 Side drive RS type 】

● It examines to drop off a rotary part until the tilling nail grounds, and whether or not to remove oil check plug and whether or not oil pours.

● When not pouring, it is necessary to replenish. (The refueling is page 33)

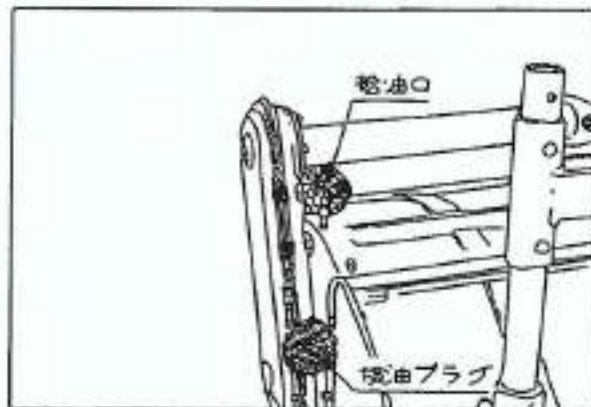

(10) The quantity of rotary case oil

【 Center-drive RK type 】

● It examines whether or not to remove a dropping-off. oil check plug and whether or not oil pours in the rotary part until the tilling nail grounds.

● When not pouring, it is necessary to replenish. (The refueling is page 34)

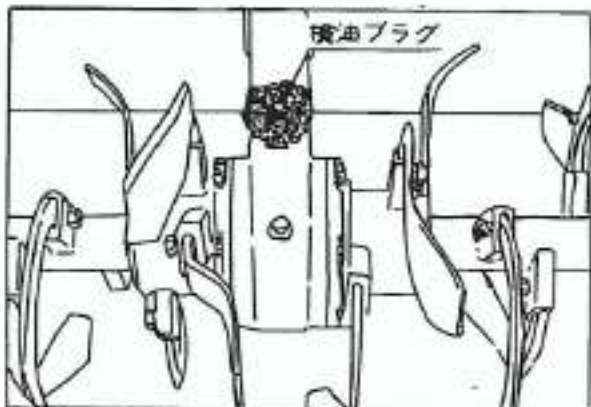

(11) The confirmation of the pending-lock of the lock pin of the universal joint

The lock pin or anyhow, as for the confirmation, it examines whether or not the head of the pin sticks out by equal to or more than 7 mm about whether or not it fell into a ditch correctly.



(12) The play of the brake pedal

When the adjustment of the brake is bad, it leads to the accident resulting in injury or death, too. Be always careful of the operating condition.

It works a pedal and it examines whether knocking over quantity of 30 - 40 mm and either side brake doesn't become not gathered in the play quantity.

(The adjustment is page 41)

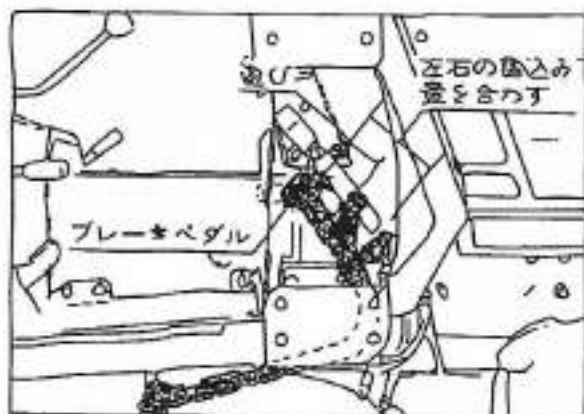

(13) The play of the clutch pedal

When the adjustment of the clutch is bad, it causes the slip in the occupied clutch and the power can not be sufficiently told.

Confirm whether the play quantity of the clutch pedal is 20 - 30 mm.

(The adjustment is page 41)

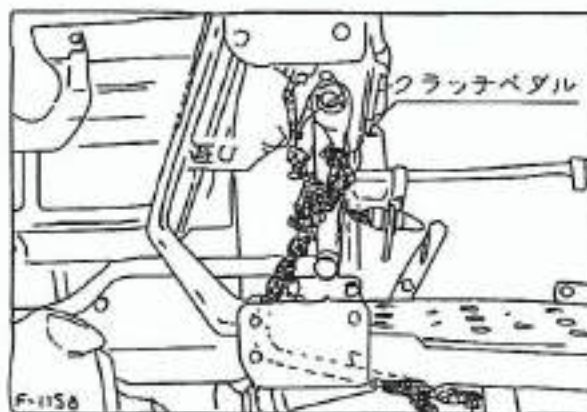

(14) The play and the gutter of the handle

When the adjustment of the handle is bad, the handle becomes heavy and the go-ability becomes bad. It examines the play when moving a handle to either side lightly. (20-50mm)

(The adjustment is page 42)

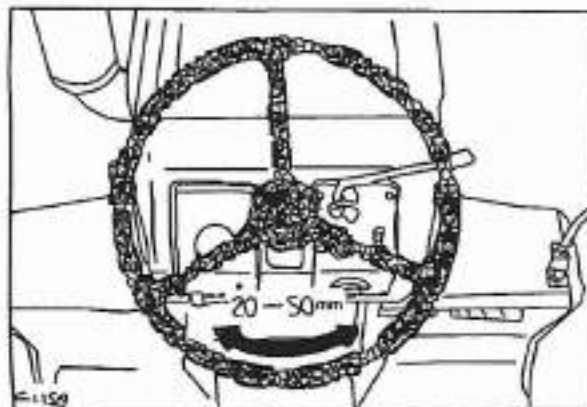

(15) The color of exhaust

The colorless normality

It is the imperfect combustion because black fuel is too thick.

The white engine oil is burning. But, when the temperature is low, steam sometimes can be seen, being white.

The simple improvement of the tractor and the maintenance

About Fuel

Use Kubota Corporation diesel oil or diesel light oil for fuel.



【 Note 】

● Because the fuel injection pump becomes a malfunction when the garbage and sand are mixing into fuel, always replenish through the filtration network.

■ The fuel filter

The water and the garbage which is contained in fuel are settled in the filter.

It closes a tap if water and the garbage collect, remove a filtration network and remove water and garbage.

At this time, air must be always pulled out.

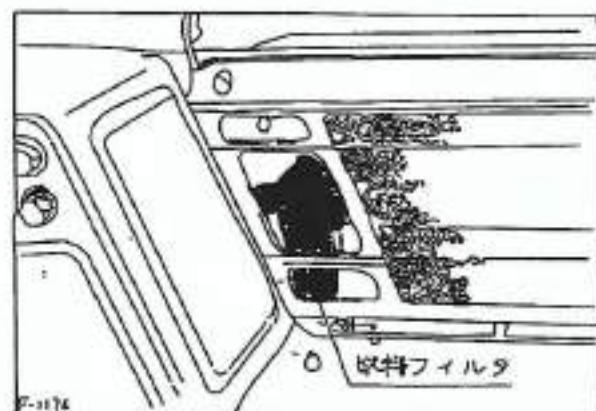

The manner of the air pulling-out

● It makes the cook of the fuel filter "ON".

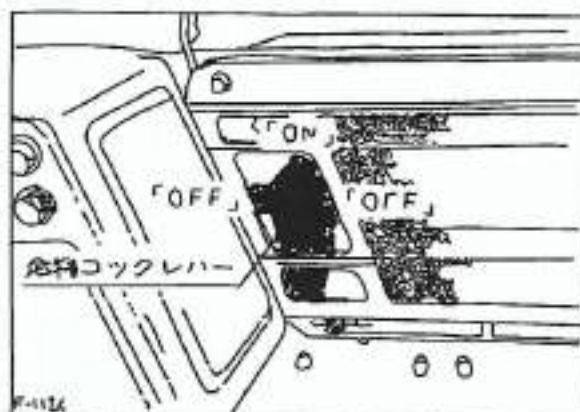

● It opens a cook on the fuel injection pump and a fuel filter overhead cook.

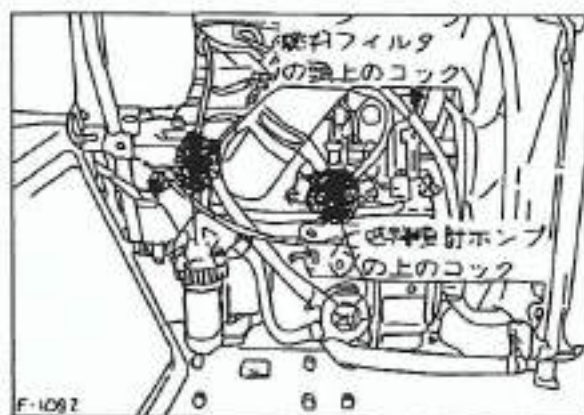

● It puts fuel in approximately half (the halfway with fuel level gage) to the tank.

● It closes a cook on the territory of the fuel filter.

● It puts fuel until the tank becomes fill up the tank.

● It starts and after operating for about 1 minute, it stops an engine.

● It closes a cook on the fuel injection pump.

【 Note 】

● The cook on the fuel injection pump and the fuel filter overhead cook always close beforehand the others when pulling out air.

It causes the breaking-down.

The refueling to each part and the exchange

The engine oil, the transmission oil, the gear oil to use always use Kubota Corporation pure oil. (Page 55 reference)

■ The exchange of the engine oil

● It removes a draining-plug and it lets out oil.

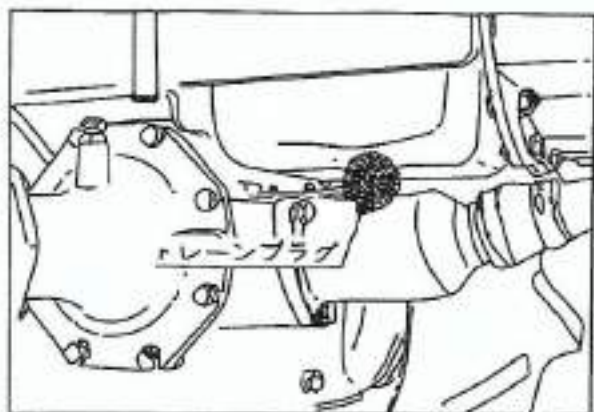

● Put the engine oil in the regulation quantity from the fuel tank cap. (About 3.4 liters)

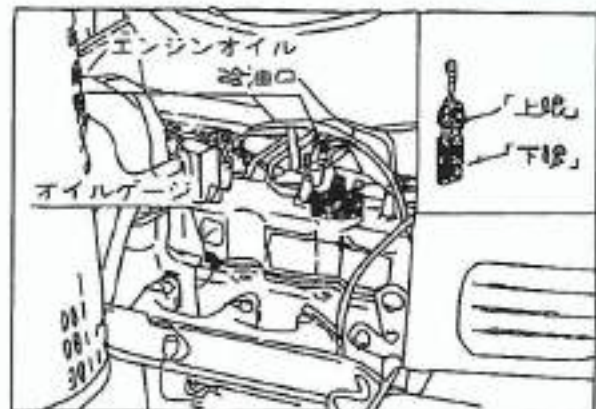

■ The exchange of the transmission oil

● It removes a draining-plug and it lets out oil.

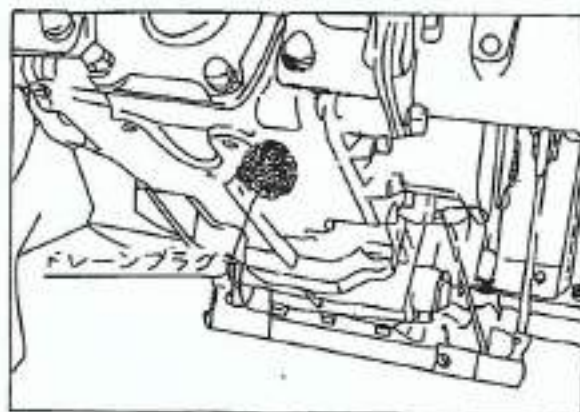

● From the fuel tank cap of the transmission oil Accept to the regulation quantity. (About 1 liter)

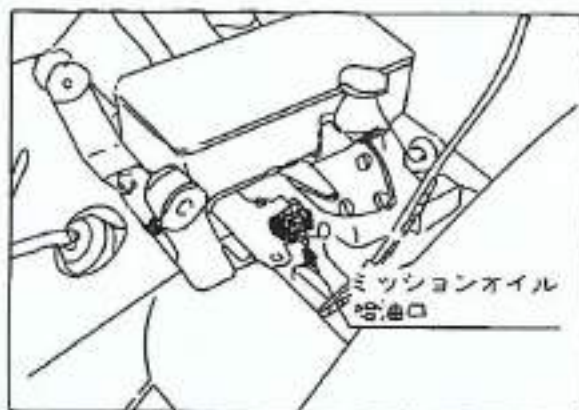

■ The replenishment of the oil of the steering gear box When lacking, it is necessary to replenish transmission oil under the fuel tank cap.

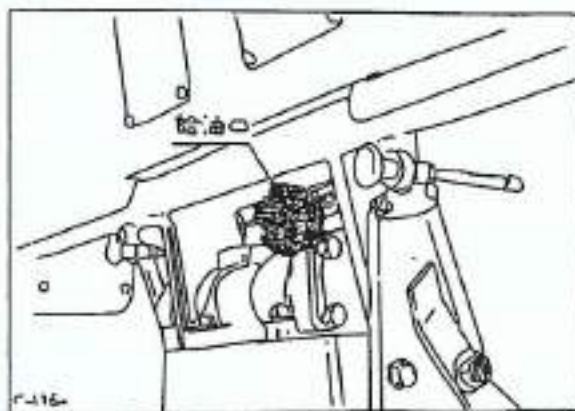

■ The exchange of the oil of the previous defense gear case [The 4WD DT specification]

● It removes a draining-plug and it lets out oil.

● Pour gear oil SAE90 in the regulation quantity from the fuel tank cap. (1.5 liters)

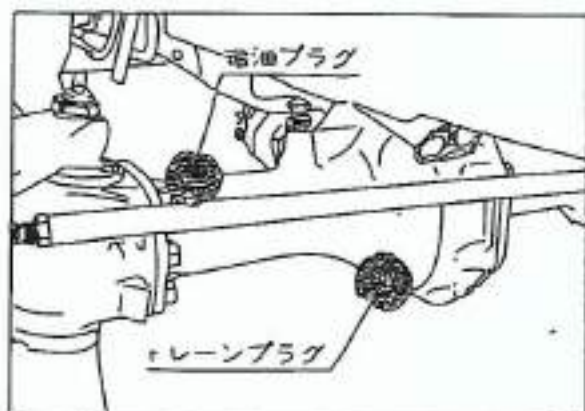

■ The one of oil on the drive-axle case right and the left

The exchange [The 4WD DT specification]

● It removes a draining-plug on either side and it lets out oil.

● Pour gear oil SAE90 in the regulation quantity from refueling [1 on either side. (0.5 liters)

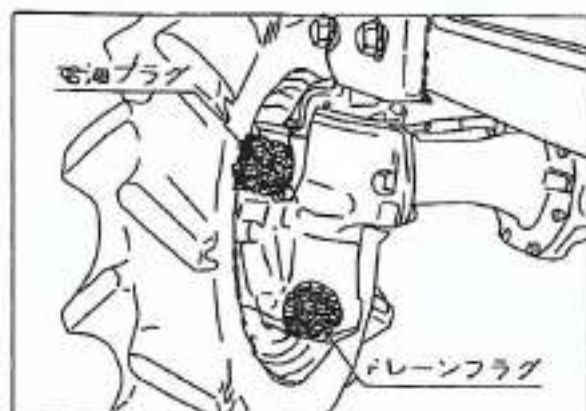

■ The exchange of the oil of The bevel gear case [The side drive RS type]

● It raises a rotary part, it removes a draining-plug and it lets out oil.

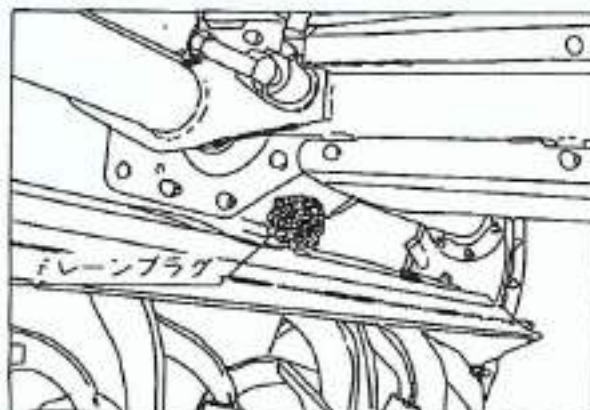

● It drops off a rotary part until the tilling nail grounds. Pour gear oil SAE90 in the regulation quantity from the fuel tank cap. (0.7 liters)

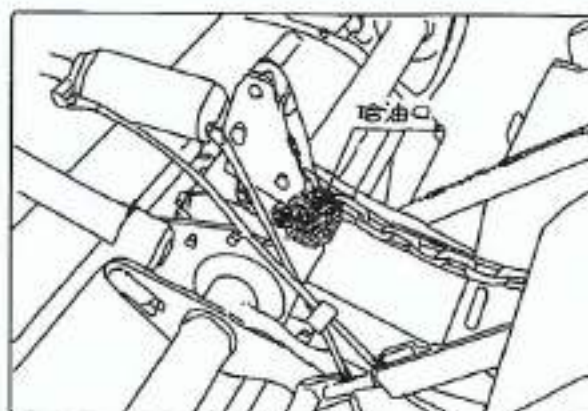

■ The exchange of the oil of the rotary case [Side drive RS type]

● It raises a rotary part, it removes a draining-plug and it lets out oil.

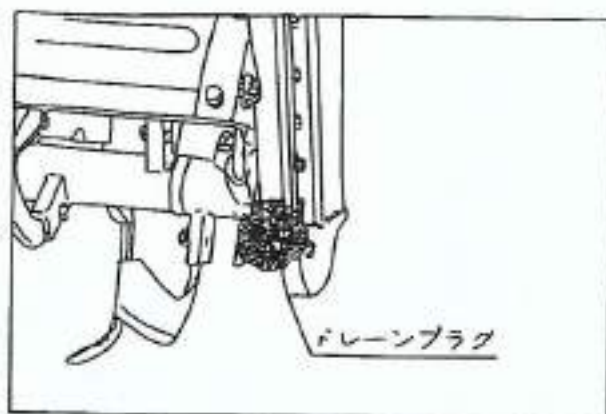

- It unloads a rotary part until the tilling nail grounds.
Pour gear oil SAE90 in the regulation quantity from the fuel tank cap. (1. 2 liters)

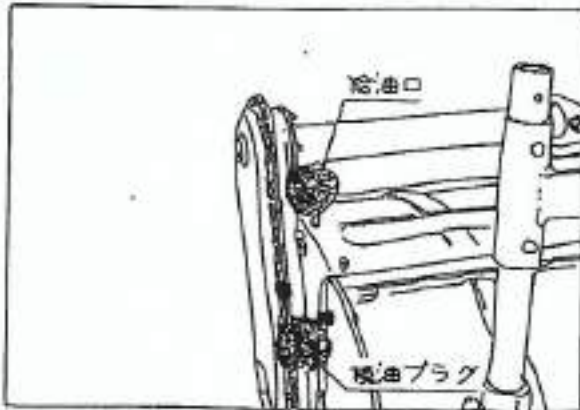

- The exchange of the oil of the rotary case
[Center-drive RK type] ● It drops off a rotary part until the tilling nail grounds, and it removes a draining-plug and it lets out oil.

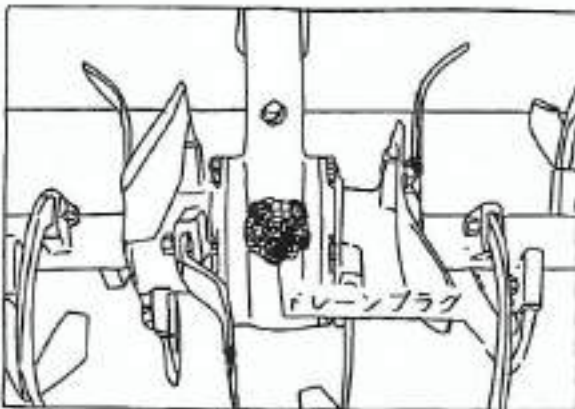

- Pour gear oil SAE90 in the regulation quantity from the fuel tank cap.
- (1. 6 liters)

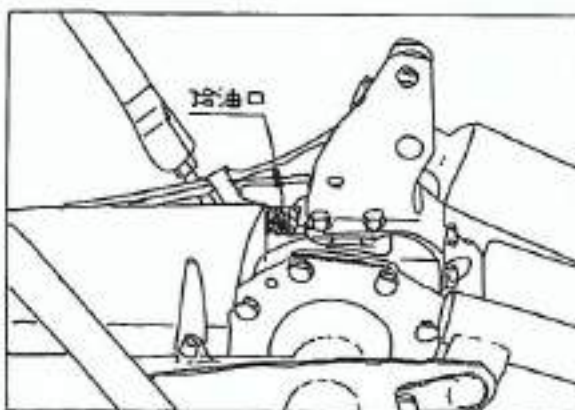

The exchange of each filter

- It removes with the filter wrench of the exchange
- attachment of the engine oil filter cartridge.



- After applying oil to the O-ring of the new cartridge thin, it puts a total surely with the hand.
- It replenishes regulation quantity with the engine oil.
- It stops an engine after operating for about 5 minutes and confirming whether or not the operation of the oil lamp doesn't have a malfunction.
- It confirms the fuel level again with the oil gauge and it must be replenished if lacking.
- It removes with the wrench of the cleaning attachment of the hydraulic pressure oil filter and it washes.

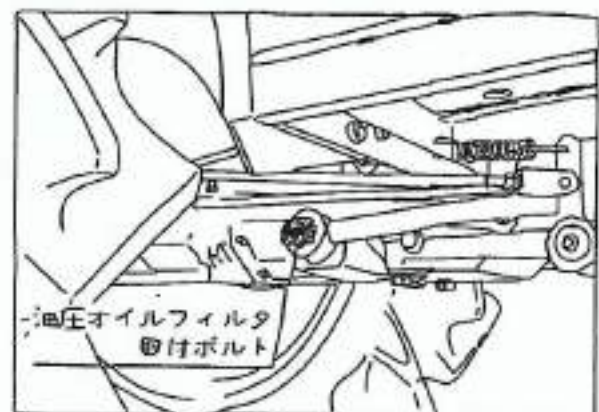

- The exchange of the fuel filter element
- Close the cock of the fuel filter.

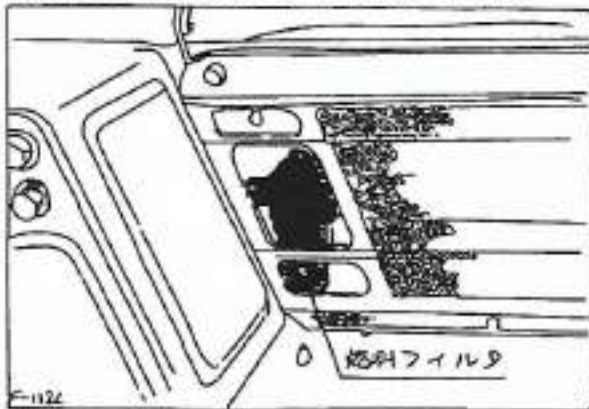

- It returns a retainer-ring in the cup upper part and it removes a cup and it washes the inside with light oil.
- It exchanges for the new filtering-element.

Note

- (1) When it is possible to grapple, let's be careful so as not for Chile and the dust to adhere.
- (2) After exchanging an element, let's always pull out air.

(Page 31 reference)

The exchange of cooling water

■ The manner of the exchange

- It opens a drain-cock and a radiator cap in the drive-axle frame right and it lets out all cooling water.

As for the drainage of the compensating vessel, it drains the overflow pipe of the radiator cap in the removal.

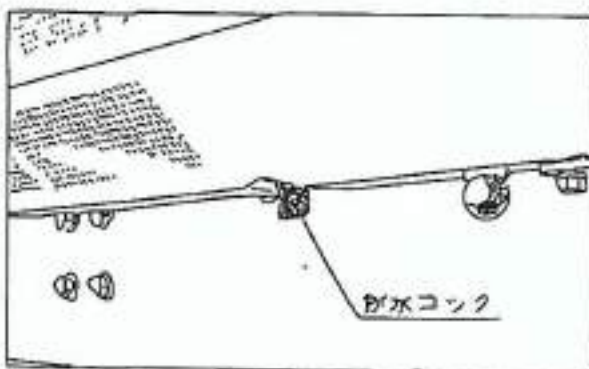

- It washes the inside of the radiator with water supply one. Pour water and it installs a drain-cock, a radiator cap, an overflow pipe.
- Water a radiator and a reserve Tank in cooling water.

■ The replenishment of cooling water

There is not need of the replenishment in generally but the cooling water of the compensating vessel replenish just under the level of FULL in the case below LOW.

Don't put above FULL.

Safety Point

- When it is possible to open a radiator cap during engine operating and immediately after stop, make open after that boiling water spouts gets cold after equal to or more than 10 minutes after being. stops.
- It sometimes burns with boiling water when neglecting it.

■ Radiator detergent No.11

(When not putting anti-freeze)

- (1) It prevents from water dirt generation by cooling water. When the water dirt collects, the chilling effect declines remarkably.

- (2) Let's make exchange once, cooling water to 3 months because the effect of the detergent lasts for 3 months.



■ How to use of the anti-freeze

The anti-freeze has the effect which lowers the freezing point of water and prevents the damage of the cylinder and the radiator by the cooling water freeze. At the time as the winter temperature becomes equal to or less than 0 ° C, always mix the anti-freeze of the permanent wave type (the PT type) with water and replenish a radiator and a compensating vessel with it. (An anti-freeze Long Life coolant is included in the time of shipment from factory)

【 Note 】

- (1) Because the mix proportion of the anti-freeze depends on the manufacturer and the temperature, too, little, follow the instruction manual of the manufacturer.
- (2) When using anti-freeze, don't invest a radiator detergent.

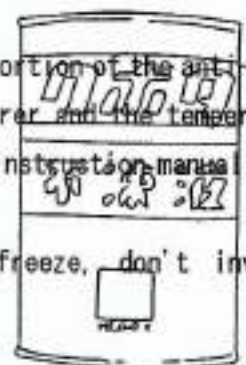

The sludge sometimes generates when the detergent mixes because a corrosion inhibitor is stored in the anti-freeze.

has a bad influence on the engine part.

(3) In the valid period of service of the Kubota Corp. anti-freeze, it is 2 years.

■ The cleaning of an insect screening

When using for farm and the night work, the fruit of the grass and the insect which doesn't come adhere to the insect screening and are sometimes choked up. In such a case, clean an insect screening.

< note >

● To work on straw ash and the withered grass, the garbage, do a check and cleaning briskly. Then, the engine make not start overheat.

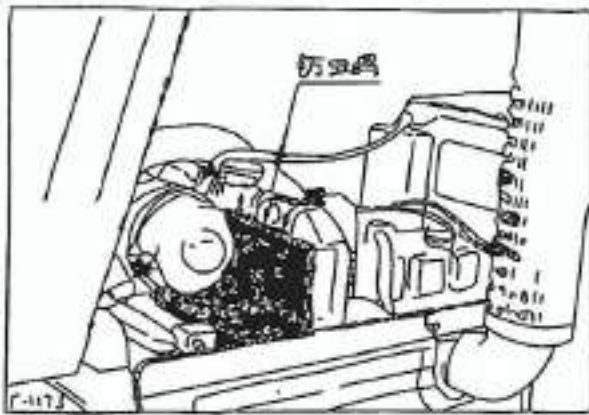

■ The cleaning of radiator core

When garbage is stored between the fin and the tube, pour with the tap water (the pressure water).

【 Note 】 ● Don't clean in the solid ones such as the spatula and the driver.

becomes the cause which loses the feature of the damaging radiator in the special fin.

■ The wash of the radiator

If using Kubota Corp. radiator lotion No. 20 for the wash, it is possible to wash in the beauty of the water dirt and so on.

- It is use in every 500 hours.
- When mixing anti-freeze
- When boiling only water from the anti-freeze mixing and changing it, use others.

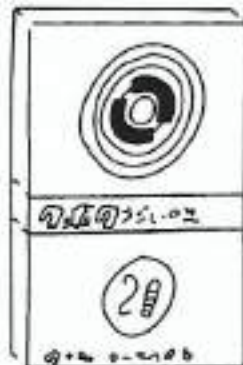

■ When leaking from the radiator

(1) In case of a little water leaking, if using Kubota Corp., radiator cement No. 40, it stops.

(2) When the water leaking is vigorous, consult the purchase shop and the agricultural cooperative to have bought.

■ The exchange of the air cleaner element

■ The way of removing an element

● It removes an air cleaner cover and it removes a butterfly nut.

● It lifts air cleaner a little and it takes out an element.

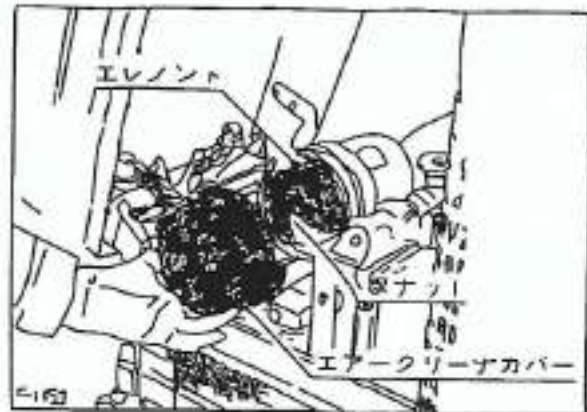

■ The cleaning of an element

Blow air or the cleaning of an element remove garbage from inside the element prosperous lightly with the hand.

■ The exchange of the element

Of the use later or the exchange of the element needs 1 year of exchange six times every time it cleans up.

【 Note 】

(1) Because it is using a dry process element, don't use oil.

(2) The element doesn't touch unnecessarily except the cleaning and the exchange.

■ The replenishment of the battery acid

The battery electrolyte in the battery evaporates while using and decreases.

(1) The liquid level is UPPER LEVEL and LOWER LEVEL. It should be among both LEVEL and rarely, it is necessary to replenish distilled water to UPPER LEVEL.

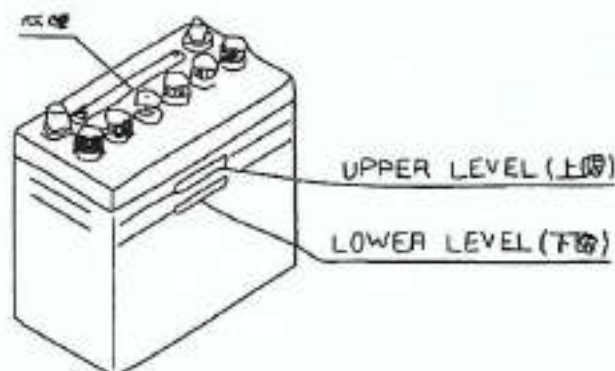

note >

(1) It damages a battery when liquid is lacking for the battery.

Liquid leaks out when many and corrodes the metallic part of the body.

(2) Avoid a boosting-charge as much as possible. It makes a battery lifetime short.

(3) When connecting a code with the battery, make not mistake a positive and a minus.

Fusible link breaks down when mistaking.

(4) When removing a cord from the battery, do from the side of the negative, the side of the positive when installing.

When making opposite, it short-circuits when the tool hits.

(5) The charging do a battery charger in the ordinary way of charging in being positive and the reduction of the battery by the battery charger in plus of the battery, connecting respectively negatively.

Safety Point

● Make not put a battery acid to the body and the clothes.

Adherently, scour off immediately with water.

When neglecting it, with dilute sulfuric acid, it sometimes burns.

■ The check of the pipe kind

The rubbers such as the fuel line and the coolant-hose are the consumables which age even if it doesn't use.

In every 2 years or when spoiling, it is necessary to exchange for the new article with the tightening band.

(1) Be always careful of whether the pipe kind and the tightening band loosen and whether they don't spoil.

(2) When exchanging a fuel line kind, air must be always pulled out.

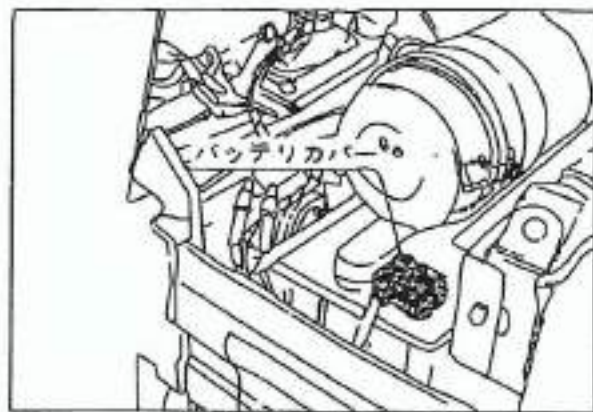
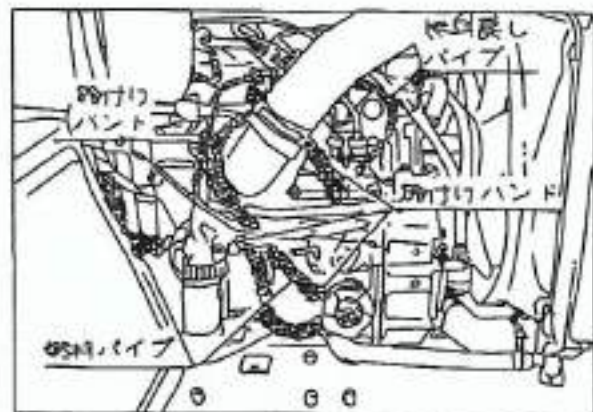
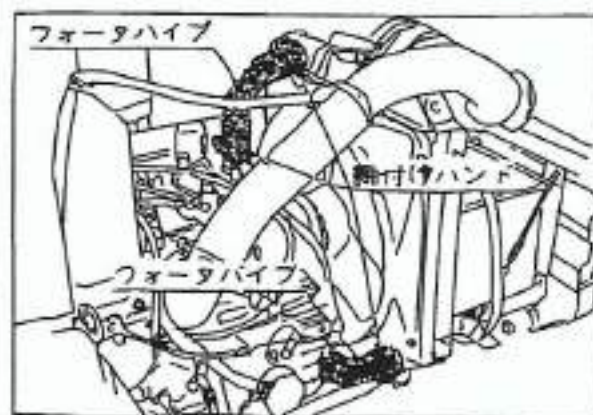

[Note]

● Be careful so as not for garbage to be stored in the pipe and the bulk-injection pump and so on in exchange.

It causes the malfunction of the bulk-injection pump when garbage is stored.

Safety Point

- Because it causes fuel leakage when the fuel line damages, let's always check.
- It causes life accidents such as the fire when neglecting.

The injecting part of grease

Let's always do a glee swap when entering into muddy water by the correction of do according to the regular inspection part list usual glee swap. the plowing and irrigating the fields work and so on and also after the work on the 1st ends.

Grease use Kubota Corp. recommendation grease. (The page 55 reference)

■ The grease injecting into each part

It injects a little chassis grease.

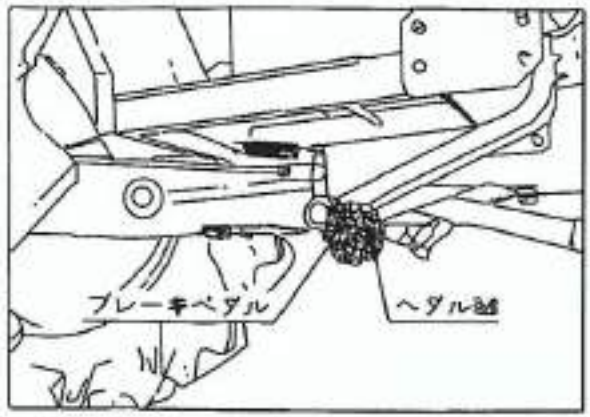
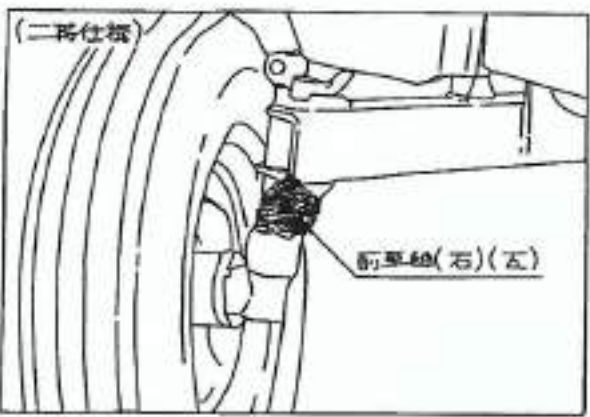
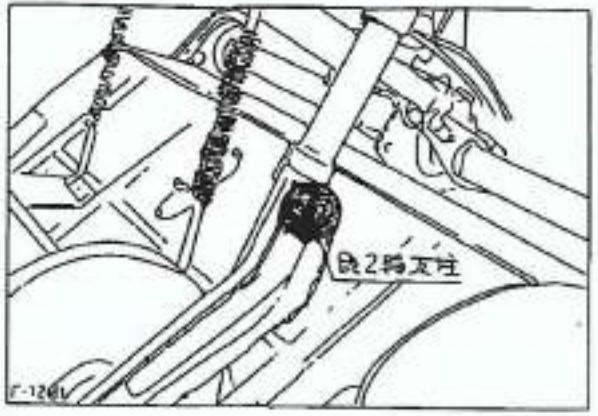
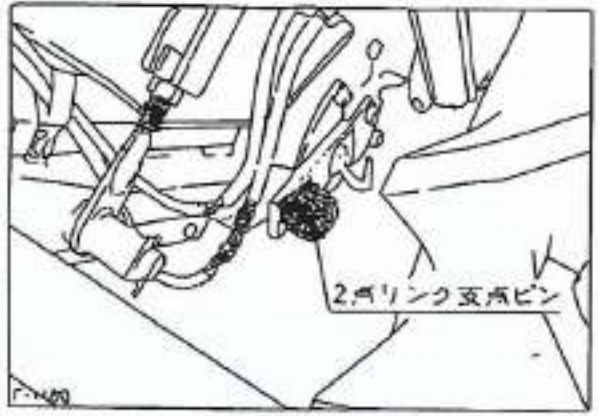
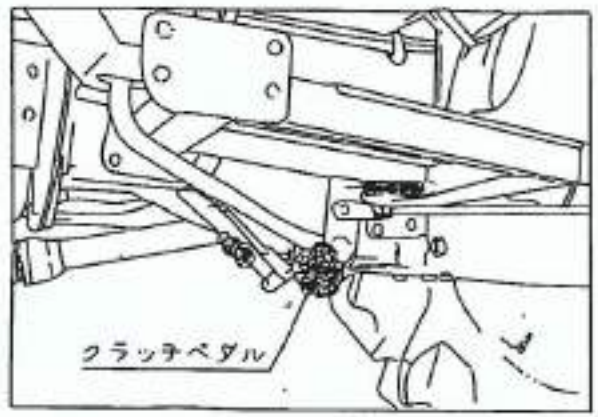

■ The clutch operator hub

It removes the cap of the housing case and it injects bearing grease by the fico.

(Injecting degree of twice of grease pumps)

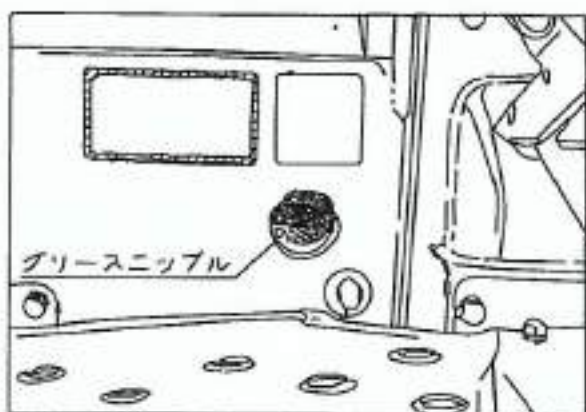

■ The rotary side frame

[Side drive RS type]

It removes a cover in the side frame lower part and it injects bearing grease.

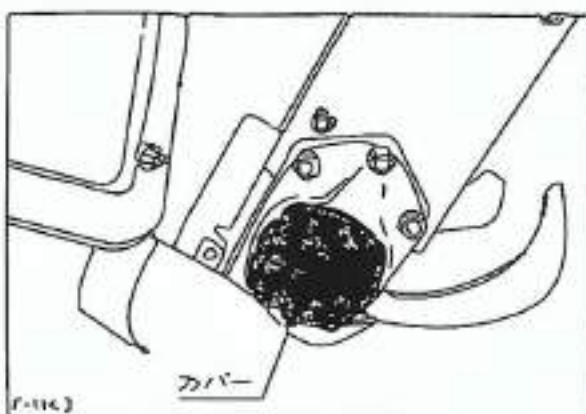

■ The application of grease to the spline part of the joint

It removes a joint and it applies bearing grease to the PTO axis and the axis on the side of the rotary thin.

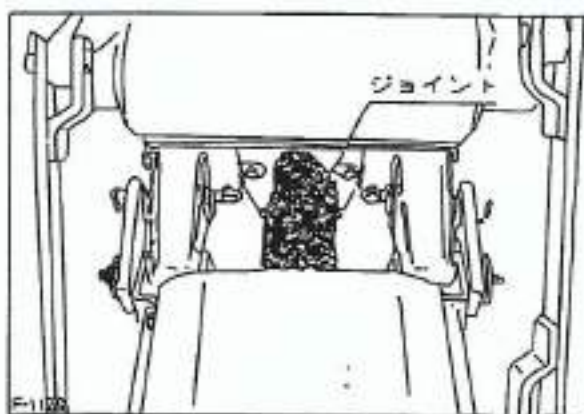

■ The nose wheel hub [The 2WD specification]

It injects a little bearing grease.

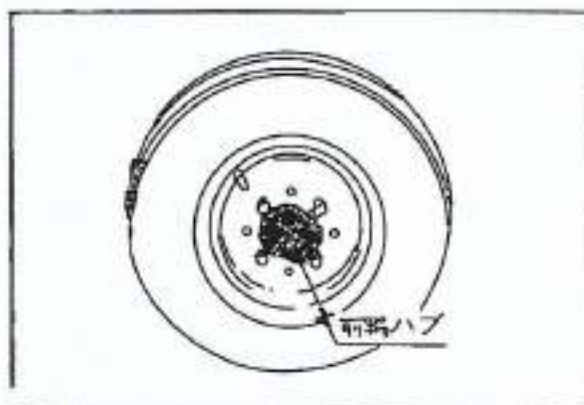

The adjustment of the track

■ The nose wheel

The track of the nose wheel can not be changed.

■ The rear wheel

● It cheers up a rear wheel on either side with the jack.

● It loosens Bolt Nut and it removes a tire and it replaces either side.

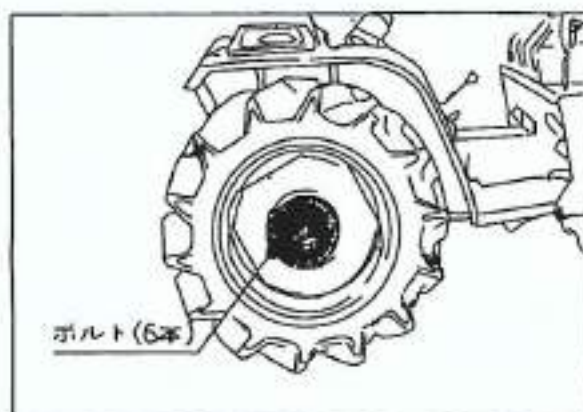

The track of the rear wheel can be controlled to two kinds.

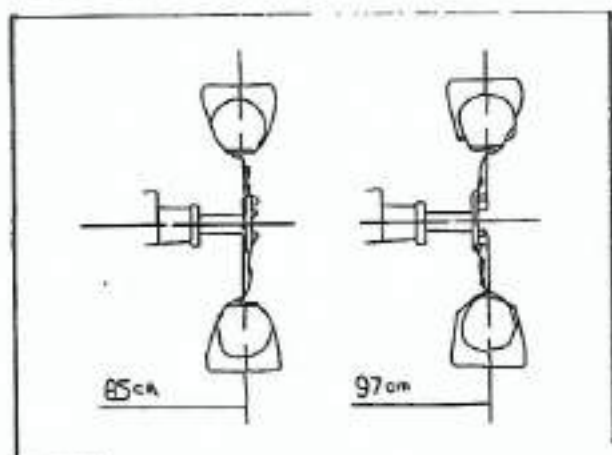

【 Note 】

- (1) Install for the tire to fit the direction of rotation when the arrow in the side moves forward.
- (2) Straike is installed only at the time of standard track (85cm).
- (3) A rear wheel weight is gotten at the time of standard track (85cm).

Safety Point

- In case of work inside the tow work and in the sloping ground and so on, make a track wide and use.
- At the minimum track, the balance on either side becomes unstable.
- It sometimes causes a life accident by the tumble when neglecting it.

The adjustment of the implement lift quantity

The mounting point of the check metal fittings can be changed by changing it by the adjustment of the lift quantity of the implement.

The rising quantity of the implement becomes small when loosening and fixing the set bolt of the check metal fittings behind.

The rising quantity becomes big when fixing in front.

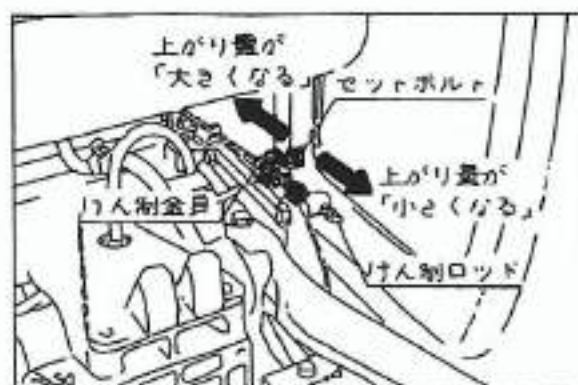

The adjustment of the depth of plowing control speed

Because the hydraulic pressure control valve has an adjusting-bolt, loosen and control a locknut with this screw.

6 - 10 seconds of strokes are suitable speed.

Adjusting Bolt	Speed
Fasten up	Slow
Loosen	Fast

After control, fasten up a locknut surely.

【 Note 】

- The speed adjustment of the descent and the rise can control the flow rate of the entrance and the exit of the double acting pneumatic cylinder by narrowing down it.

For example, when the tie-dyed cloth on the side of the rise gets (to make) a lot of (ascension-rates late), the speed becomes late about the side of the descent, too.



The adjustment of the brake

In the locknut, it turns a loosening rod and it adjusts the play of the pedal.

After adjustment, put a locknut surely beforehand with the total.

Confirm whether or not the brake pedal operates surely by the parking brake lock when stepping.

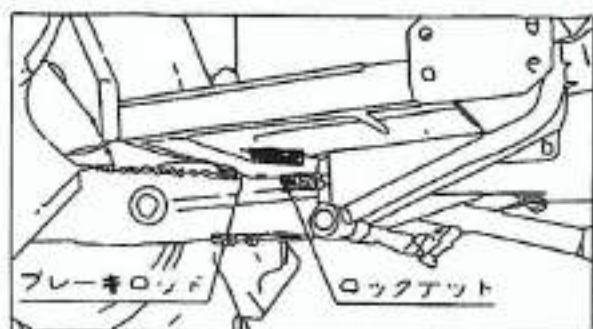

Safety Point

● Always adjust the knocking over quantity of the pedal on either side in adjustment.

The brake becomes to be too effective only in the side when not fitting.

● It sometimes causes a life accident when neglecting it.

The adjustment of the clutch

It loosens Nut, and it removes a head-attached pin and it adjusts the play of the pedal with the clutch rod.

After adjustment, put Nut surely beforehand with the total.

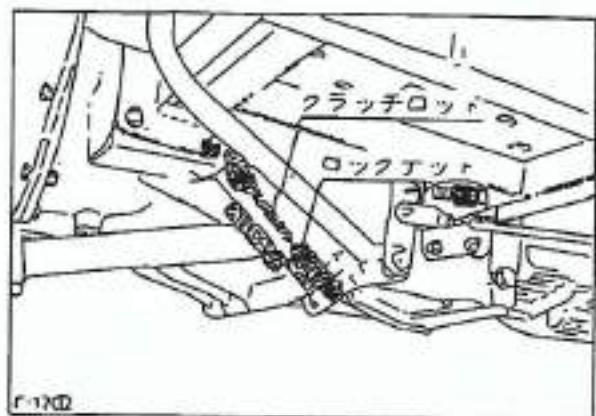

【 Note 】

● The adjusting-bolt is the one which prevents the exaggerated stroke of the diaphragm of the clutch, regulating the maximum knocking over quantity of the clutch pedal. We request so as not to touch because it commands in the time of shipment from factory and it is locked in the fixation.

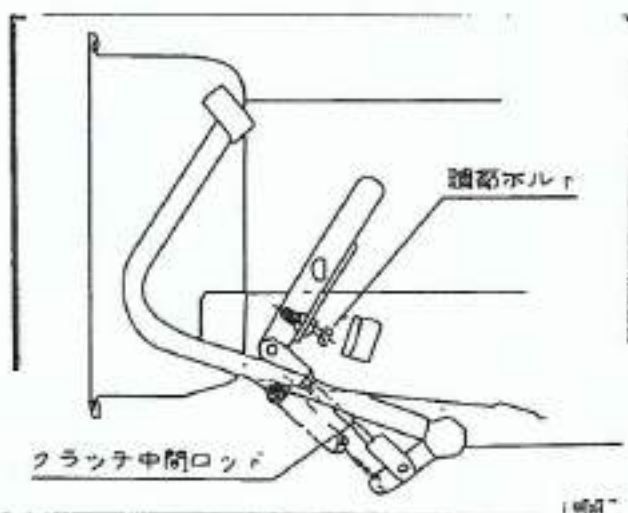

The adjustment of Fan belt

It loosens two pieces of Nut who is installing a dynamo, it moves and it adjusts a dynamo. After adjustment, put Nut surely beforehand with the total.

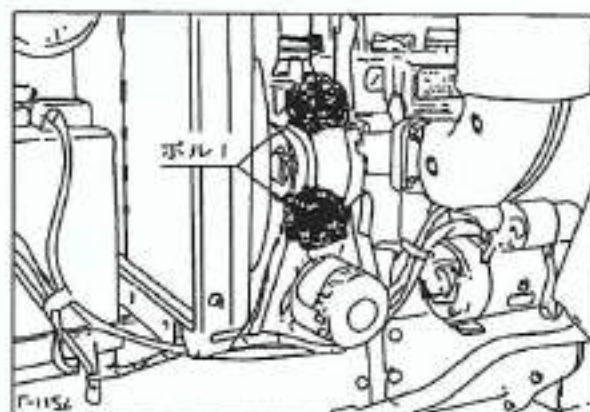

The adjustment of the steering wheel

It removes a rubber-screen and it loosens a locknut, and it turns an adjusting bolt with the driver and it adjusts play.

After adjustment, put Nut and a ball-head-lock-nut surely beforehand with the total.



The toe-in checking-adjusting

When the adjustment of the toe-in is bad, it is sometimes possible to be taken and to shake a handle extraordinarily.

■ The check of the toe-in

It measures the previous width (AB) of the nose wheel and rear width (CD) and it examines whether it becomes $(CD) - (AB) = 0\text{mm} - 5\text{mm}$



■ The adjustment of the toe-in

It loosens and it adjusts Nut of the tie rod. After adjustment, put Nut surely beforehand with the total.

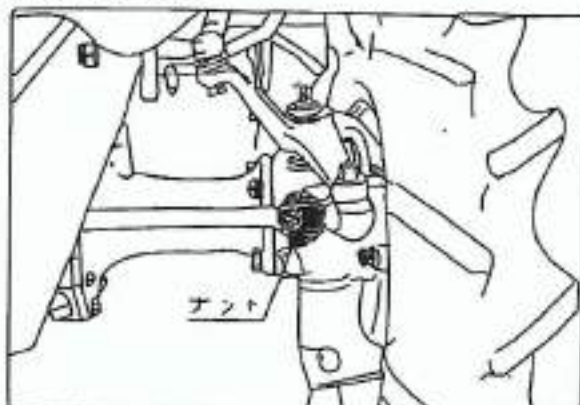

The checking-adjusting of the drive-axle support gutter

When the adjustment of the drive-axle support is bad, the nose wheel moves remarkably and the vibration spreads through the handle.

■ The check of the support gutter

It checks and it adjusts the gutter of the anterior-posterior if there is a gutter.

■ The adjustment of the support gutter

It removes a center pin stop spring, the total is crowded and adjusts a gutter in the slotted nut.

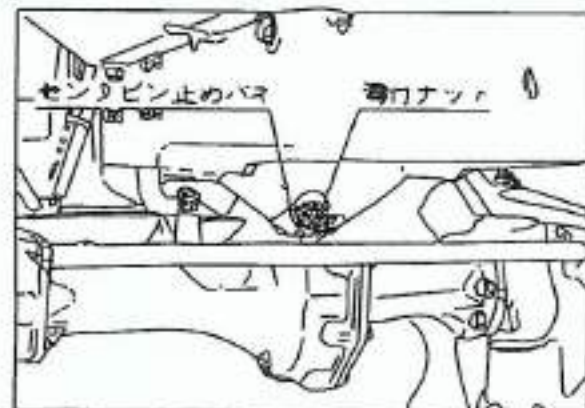

The adjustment of the rotary connections joining the two sections

When the play comes out between two link Brackett U metal fitting parts and the rotary frame fulcrum pin. It loosens the mounting bolt of the contact plate, it lifts a rotary part with the control stalk, lose a gutter and confirm that two link pins run lightly. After that, fasten up a connection plate mounting bolt.

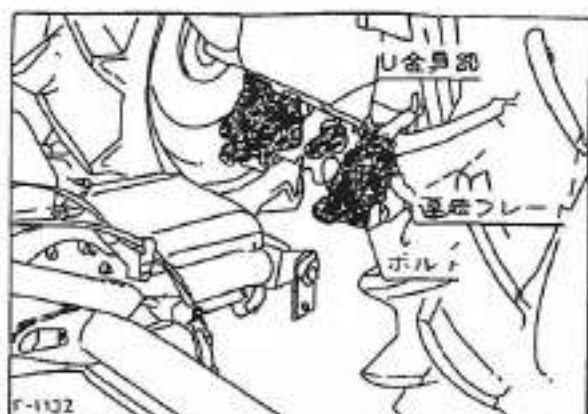

The exchange of the fuse and bulb

- The exchange of the fuse
- It removes the lid of the engine fuse board.
- It removes a fuse.
- It exchanges for the fuse with broken one and the same broken capacity.

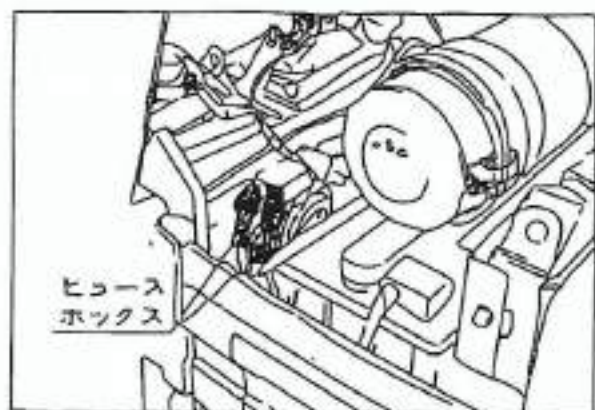

[Note]

- When a fuse is broken many times, don't use a wire and aluminum foil and so on and receive a check at the purchase shop and in the agricultural cooperative.

■ The exchange of fusible link

It removes and it exchanges a coupling.

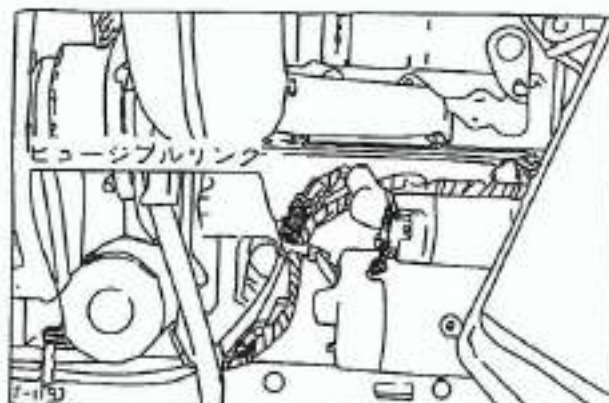

■ The exchange of the electric bulb kind

(1) The head light



(2) The turn winker bulb

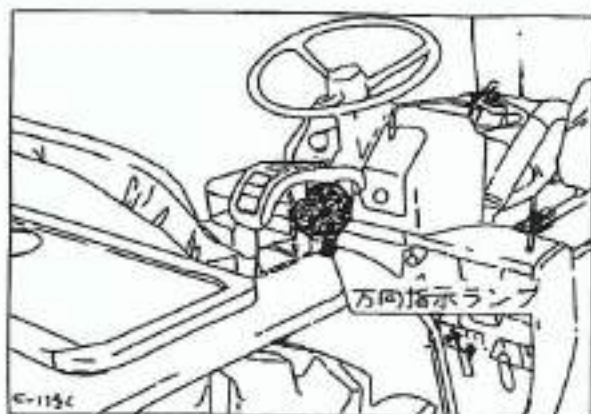

The improvement in case of the long-range storage

When not using a tractor for a long time, let's store after servicing by the following point.

- (1) Service a problem part.
- (2) It exchanges, operate the engine oil for about 5 minutes and make oil prevail in each part.
- (3) Make confirm the item of the regular inspection part list.
- (4) Do the injecting and the application of grease beforehand to the injecting of each grease and the application part.
- (5) Paint grease or oil beforehand the part where the rust of the body is cheap.
- (6) Make a fuel cock "OFF" beforehand.
- (7) Pull out cooling water, too, beforehand.
- (8) The clutch pedal hang lock metal fittings in the stepping condition in the clutch. It prevents from the rust of the clutch disc.

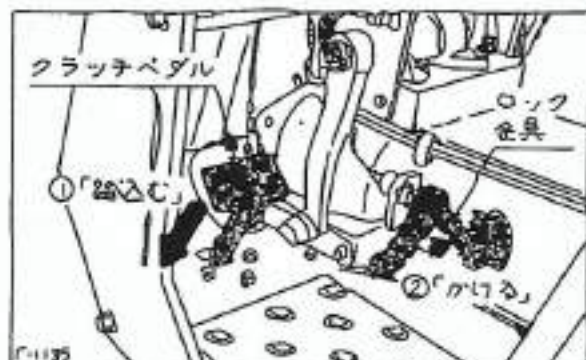

- (9) Make a little air pressure of the tire rather many from the standard.
- (10) The weight remove and make an implement the condition to have removed or for it to have been unloaded to the ground.
- (11) Check the tear of the damaging of the wiring, the battery code and the fuel pipe of each part and so on and the film, the outskirts of the code clamp surely and service them.
- (12) The battery during the storage be a taking battery charger in 1 month of. and let's be made to charge fully.
- (13) The storage place select the dry place which the rain doesn't depend on and let's make a sheet break.

Safety Point

- When hanging a sheet, boil after confirming a muffler and the cooling condition of engine itself. It becomes the cause which causes a fire when neglecting it.

The regular inspection part list

According to the following regular inspection table, always implement regular inspection.

Safety Point

When doing refueling and an inspection and maintenance, put a tractor on the flat wide place. Also, do after stopping an engine then, hanging a parking brake, hanging the chain which prevents the fall of the rotary, placing a wooden stand and so on under the nail axis more and confirming safety. It sometimes causes a life accident when neglecting it.

No.	Check Item	The hour meter display time (It exchanges every following time).										From the day of purchase		reference page		
		3	5	1	1	2	2	3	3	4	4	5	5		1	2
		5	0	0	0	0	0	0	0	0	0	0	0		year	years
1	The cleaning of the exchange hydraulic pressure oil filter of the transmission oil		@					○								32, 34
2	The exchange of the engine oil	@		○	175 hours		○	325 hours		○	475 hours					32
3	The oil replenishment by the steering gearbox				○			○			○					32
4	The changing-oil of the front defense gear case [The DT specification]		@					○								33
5	The changing-oil on the drive-axle case right and the left (DT specification)		○					○								33
6	The changing-oil of the bevel gear case [RS form]		@					○								33
7	The changing-oil of the rotary case [The RS form]		○					○								33
8	The changing-oil of the rotary case [The RK form]		○					○								34
9	The exchange of the engine oil filter cartridge				○			○			○					34
10	The exchange of the fuel filter element									○						35
11	The cleaning of an air cleaner element			○		○		○		○		○				36
12	The exchange of the air cleaner element												Every 6 time			36
13	The looseness check by the return pipe installation screw of the hydraulic pressure, and fuel and fuel		○	○	○	○	○	○	○	○	○	○				37
14	The looseness check by the coolant-hose tightening band				○			○			○					37
15	exchange of the pipe of the return of fuel													○		37
16	exchange of the coolant-hose													○		37
17	exchange of the battery cap													○		37
18	wash inside the radiator											○				36

No	Checking Item	The hour meter display time (It exchanges every following time)										From the day of purchase		Reference page
		3 5	5 0	1 0 0	1 5 0	2 0 0	2 5 0	3 0 0	3 5 0	4 0 0	4 5 0	5 0 0	ye ar	
19	Injecting part of grease ● Link fulcrum pin either side of two the front axle left and right [2RD] ● clutch pedal ● brake pedal ● pedal axis ● rear 2 ring support left and right ●		○	○	○	○	○	○	○	○	○			38
20	grease injecting by the clutch operator hub						○							39
21	grease injecting by the rotary side frame [The RS form]		@	○		○		○		○				39
22	application of grease to the spline part of the joint		○	○	○	○	○	○	○	○	○			39
23	grease injecting by nose wheel hub (2RD)						○							39

Always do @ mark after use for 50 hours for 35 hours in average

The case that the engine is a problem and the compatible

If the condition of the engine is sometimes bad, diagnose by the following table and do appropriate compatible.

Phenomeno	Cause	Compatible
When the start is difficult in the engine	(1) Fuel doesn't flow.	(1) It checks a fuel tank and it removes settled impurities and moisture. (2) It checks and it exchanges a fuel filter if dirty.
	(2) Air and water are mixing with the fuel injecting.	(1) It checks and it exchanges for the new article and it repairs a pipe and a band with the total beforehand if there is damage. (2) It pulls out air. (Page 31 reference)
When incapable to come out	(3) The oil viscosity is high at the time of the cold season cold sake and the revolution around the engine itself is heavy.	(1) It pours boiling water into the radiator. (2) It switches oil in the temperature. (In the winter, it uses D10W30).
	(4) There is not a force where the rotary force	(1) It charges in the battery. (2) It starts using the decomp equipment.
case to have stopped	excess compression, becoming such at the battery or in the rising touch.	(1) It refuels. (2) It examines fuel system. (Specifically, it is note at the aeration).
	(1) The fuel shortage	(1) It cleans an element. (1) It refuels.
exhaust color is bad	(2) The eye stuff of the air cleaner	(1) It examines fuel system. (Specifically, it is note at the aeration).
	(1) The fuel shortage	(1) It exchanges to high quality fuel. (2) It makes regular oil quantity.
When overheatin	(1) Fuel is bad quality.	(1) The check of the quantity (lacking) and the water leaking of cooling water
	(2) It passes in the entering of the engine oil. (1) Because cooling water became equal to or more than 100 ° C	(2) The check of the tension (the looseness) of Jamb belt (3) The cleaning of an insect screening

☆ When not understanding, consult the purchase shop and the agricultural cooperative to have bought.

Specification

■ The specification of the tractor

Name		B1600	B1600DT
Type		The small special motor vehicle for the farming	
Engine Model No.		D950	
Engine Type		The vertical 4 cycles of water-cooled diesel	
Cylinder		3	
Engine Capacity		927cc	
maximum output / turning speed		16PS/2600 r. p. m.	
cylinder bore × journey		75 × 70mm	
Fuel		Kubota Corp. diesel oil or diesel light oil	
The starting method		The cell starter type (With the glow plug hand decomp equipment)	
The cell start output		12V, 0.8kW	
The lubricating-system		The 4 leaf trochoid pump full-automatic force-feed-lubrication	
The cooling system		The pressurization radiator type (Controlled circulation 0.9kgf/cm ² by the cooling water circulation pump)	
The battery capacity		NS70L (12V65Ah) equivalent	
Fuel Tank Capacity		20 Liters	
Engine Oil Capacity		3.4 Liters	
Coolant Water Capacity		3.4 Liters including Reserve Tank	
Transmission Oil Capa.		17 Liters	
Dimensi on	Length	2420mm (without Rotary Tiller)	
	Width	1090mm (without Tiller, Wheel Width 850mm outside)	
	Height	1890mm	1900mm
wheel base		1350mm	
height on the most low land		305mm (Clutch Link)	240mm (nose wheel)
Wheel base	Nose Wheel	730mm	770mm
	Rear Wheel	850mm (Standard), 970mm	
Wheel Size	Nose Wheel	4.00-12-4PR	5.00-12-4PR
	Rear Wheel	8.3-22-4PR (New Balance Wheel)	
Weight		620kg (without Tiller, Dry)	640kg (without Tiller, Dry)
P.T.O. Shaft	taking-out part	Rear of Transmission Case 1 (Front part of Engine 1)	
	Height from Ground	460 mm	
	Rotation	It sees from behind and it is a dextroversion. (Clockwise)	
	gear paragraph / the number	3	
axis size		6 Splines Diameter 35mm	
Clutch		Dry Single Plate	
conduct equipment		Ball Screw Type	
gear method		gear choice religious type (The part constant mesh type)	
Gear Forward / Reverse		Forward 12 - Reverse 4	
Minimum Turn		1.75m	1.79m
Brake		The 1 system either side independence, the inside Extension type (With the connector)	
The differential gear		Only rear wheels	Nose and Rear Wheels