

**OPERATOR MANUAL**

**Solis 26**

**Solis**

**INTERNATIONAL TRACTORS LIMITED**

**HOSHIARPUR  
INDIA**

Part No. 10013156AA



## OWNERSHIP AND TRACTORS DETAILS

<b>OWNER'S NAME &amp; ADDRESS</b>	<hr style="border-top: 1px dashed black;"/>  <hr style="border-top: 1px dashed black;"/>
	.....TEL.NO.....

Model :	Delivery Date :
Chassis No. :	Bill No. / Date :
Engine No. :	Alternator Make / Sr. No. :
Battery Make / Sr. No. :	Starter Motor Make / Sr. No. :
FIP Sr. No. :	Hydraulic Pump Make / Sr. No. :

Tyre	Make	Size	Sr. No.
Front (Left)			
Front (Right)			
Rear (Left)			
Rear (Right)			

I have understood all the terms & conditions of the maintenance of the tractor, terms of warranty, systems, Scheduled services & understood operation of tractor in the field and other operations.

Received a new defect free tractor Chassis No. ....

Engine No. .... & fully satisfied with the transaction.

<b>OWNER'S SIGNATURE</b>	<b>DEALER STAMP &amp; SIGNATURE</b>
	PH. NO. .... DATE: .....

**\* IMPORTANT INFORMATION TO CUSTOMER:** For any assistance with regard to our product, please contact our authorized dealer or authorized service center.



## OWNERSHIP AND TRACTORS DETAILS

<b>OWNER'S NAME &amp; ADDRESS</b>	
	TEL.NO. ....

Model :	Delivery Date :
Chassis No. :	Bill No. / Date :
Engine No. :	Alternator Make / Sr. No. :
Battery Make / Sr. No. :	Starter Motor Make / Sr. No. :
FIP Sr. No. :	Hydraulic Pump Make / Sr. No. :

Tyre	Make	Size	Sr. No.
Front (Left)			
Front (Right)			
Rear (Left)			
Rear (Right)			

I have understood all the terms & conditions of the maintenance of the tractor, terms of warranty, systems, Scheduled services & understood operation of tractor in the field and other operations.

Received a new defect free tractor Chassis No. ....

Engine No. .... & fully satisfied with the transaction.

<b>OWNER'S SIGNATURE</b>	<b>DEALER STAMP &amp; SIGNATURE</b>
	PH. NO. .... DATE: .....

**\* IMPORTANT INFORMATION TO CUSTOMER:** For any assistance with regard to our product, please contact our authorized dealer or authorized service center.





## PREFACE

Dear Customer,

We welcome you with great pleasure for joining ITL family and thanks for faith and trust you have placed in the careful selection of your tractor.

We are sure that our dealer must have taken good care while delivering tractor upto your satisfaction.

Before using tractor, it is recommended to read this manual thoroughly. Any person who uses the tractor should be also advised to read these instructions.

Daily and routine maintenance operations can be easily performed with the use of this manual. To get best and trouble free performance from you tractor. Please ensure for periodic maintenance as per recommended schedule in the owner's manual at authorized dealership.

Use only genuine ITL spare parts from dealer/stockist for reliable and durable performance.

Information provided in this operator manual is accurate at the time of printing. Improvements and modifications are a continuous process at **International Tractors Limited (ITL)**, therefore ITL reserves the right for modification at any time without prior notice.

For any help/support feel free to call our dealership with the tractor details like Engine number and Chassis number.

We wish you prosperity and growth.

### **Export Department**

#### **INTERNATIONAL TRACTORS LIMITED**

Vill.-Chak Gujran, P.O. Piplanwala 146022

Jalandhar Road, Hoshiarpur, Punjab, India.

Phone: +91-1882-302-525/526

E-mail: [exports@sonalika.com](mailto:exports@sonalika.com)

## YOUR RIGHTS

While taking delivery of new “**SOLIS 26**” Tractor, kindly ask the dealer to give following items\*:

### 1. Tool kit which includes

- Grease Gun 1 pc
- D-spanner 10X11 1 pc
- D-spanner 12X13 1 pc
- D-spanner 14X17 1 pc
- D-spanner 18X19 1 pc
- D-spanner 20X22 1 pc
- D-spanner 30X32 1 pc
- Ring spanner 24X27 1 pc
- Ring spanner 16X17 1 pc
- Battery Guarantee Card 1 pc

### 2. Farmer kit which includes

- Fuel Filter Cartridge 3 pc
- Linch Pin 3 pc
- Tyre Pressure Gauge 1 pc
- Fuse Set 1 pc
- Fuel Tank Cap 1 pc
- Radiator Cap 1 pc
- Fan Belt 1 pc
- Air Cleaner Hose 1 pc

### 3. To avail the services.

### 4. To call dealers any time for any breakdown.

### 5. Additional Accessories as Standard fitment

- Plough Lamp
- Rear View Mirror

\* Charges applicable as per Invoice.



# CONTENTS

DESCRIPTION	PAGE NO.
<b>CHAPTER 1: TRACTOR IDENTIFICATION</b>	
Chassis Serial Number .....	15
Engine Serial Number .....	15
Statutory Plate.....	15
ROPS Certificate Plate.....	15
<b>CHAPTER 2: INTRODUCTION, WARRANTY &amp; SAFETY NOTES</b>	
Introduction .....	19
Warranty Policy .....	20
Safety Notes.....	22
<b>CHAPTER 3: INSTRUMENTS &amp; CONTROLS</b>	
Universal Symbols .....	33
Controls.....	34
Instrument Panel.....	35
Fuel Gauge .....	36
Engine Oil Pressure Gauge .....	36
Left Turn Indicator .....	36
Right Turn Indicator.....	37
Gear Lever Position Indicator .....	37
Temperature Gauge .....	37
Cold Start Indication.....	38
Battery Charge Indication .....	38
Engine RPM cum Hour Meter .....	38
Air Cleaner Clogging Indicator .....	38
High Beam Indicator.....	38
Dashboard Controls .....	39
Hazard Warning Light Switch.....	39
Combination Switch .....	39
Starting Key (Ignition) Switch .....	40
Beacon Light Switch.....	40
Fuse Box.....	41
Lights.....	41
Plough Lamp.....	41
Beacon Light .....	42
Driver's Seat .....	42
Registration Plate.....	43
Seven Pin Socket.....	43
Tool Box .....	43
<b>CHAPTER 4: OPERATION</b>	
Boarding & Leaving the Tractor .....	47
Engine: Starting the Engine .....	47
Engine: Cold Weather Starting.....	47
Engine: Running In .....	48

# CONTENTS

<b>DESCRIPTION</b>	<b>PAGE NO.</b>
Engine: Turning off the Engine .....	48
Under Hood Muffler .....	49
Opening the Bonnet .....	49
Accelerator Pedal .....	49
Clutch Pedal .....	49
'2WD/4WD' Lever .....	50
Hand Throttle Lever .....	50
Gear Shifter Lever .....	50
Power Take Off (PTO) .....	51
Using Implements with PTO Drive Shafts .....	52
Hydraulic Coupling Devices .....	53
Power Steering .....	53
Transport Lock .....	54
Hi-Low Lever .....	54
Differential Lock Pedal .....	54
DCV Lever .....	54
Service Brakes .....	55
Parking Brake .....	55
Ground Speed Chart .....	56
Wheels and Tyres .....	57
Ballasting of Tyres .....	58
Hydraulic .....	58
Three Point Linkage .....	59
 <b>CHAPTER 5: MAINTENANCE</b>	
Maintenance Schedule .....	63
Fuel Tank Filling .....	65
Fuel Requisites .....	65
Fueling .....	65
Fuel Storage .....	65
Checking Engine Oil Level .....	66
Replacement of Oil Filter and Engine Oil .....	66
Replacement of Fuel Filter .....	67
Coolant Level in Radiator .....	67
Radiator Draining and Flushing .....	68
Radiator Fins Cleaning .....	68
Radiator Cap .....	68
Inspection of Hoses .....	68
Air Cleaner (Dry Type) .....	69
Clutch Pedal: Free Play Adjustment .....	70
Foot Brake Pedals: Free Play Adjustment .....	70
Steering Cylinder Knuckle Joints .....	70
Oil Changes in 4WD Front Axle .....	71
Oil Changes in Transmission, Rear Final Drives and Power Lift .....	71
Recommended Oil Grade & application Range .....	72
Cleaning of Suction Strainer .....	72

# CONTENTS

<b>DESCRIPTION</b>	<b>PAGE NO.</b>
General Maintenance of Electrical System .....	73
Battery and its Maintenance .....	73
Starter Motor .....	75
Alternator.....	75
V-belt Checking and Adjustment .....	75
Fuses in Fuse Box .....	76
Long Idle Period .....	76
Greasing Points.....	77
Jack Up the Tractor - Lifting Points .....	78
Oil and Lubrication Chart .....	79
Electrical Wiring Circuit Diagram.....	81
<b>CHAPTER 6: TECHNICAL SPECIFICATIONS</b>	
Technical Specifications .....	85
Implement Specifications .....	86
<b>CHAPTER 7: DO'S AND DON'TS</b>	
Do's and Don'ts .....	91
<b>CHAPTER 8: TROUBLESHOOTING</b>	
Troubleshooting .....	97
<b>CHAPTER 9: INSTALLATION CERTIFICATE &amp; SERVICE RECORD</b>	
Installation Certificate .....	101
Service Record.....	103



## **CHAPTER - 1**

# **TRACTOR IDENTIFICATION**



# TRACTOR IDENTIFICATION

## Chassis Serial Number

The chassis and/or engine serial numbers are used to register the vehicles. They are also used to assist your dealer when ordering or referring to special service information. Whenever you have occasion to consult your dealer, remember to identify your vehicle with this number. Chassis number is punched on right hand side of the front axle bracket. Should you find the number difficult to read, you will also find it on the Statutory plate.



## Engine Serial Number

The engine serial number is stamped on the upper side of the fuel injection pump installation part located in the right side of cylinder block.

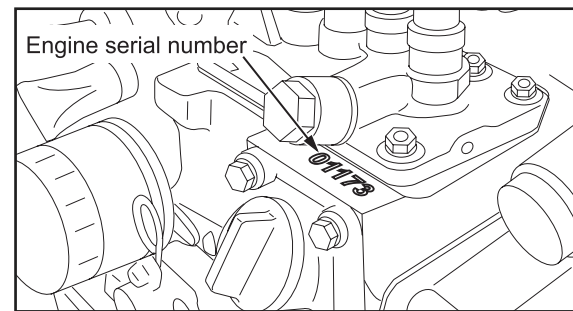

For easy and quick reference, engine serial number is also mentioned on the information sticker which is pasted on valve cover of the engine as shown in Fig.



## Statutory Plate

Chassis number is also engraved on Statutory plate which is located inside of the bonnet.

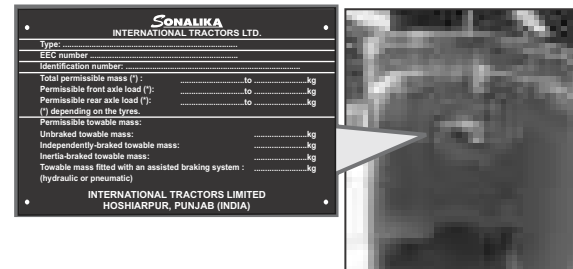

## ROPS Certificate Plate

ROPS certificate plate is riveted on ROPS as shown in Fig. Information about ROPS serial number and tractor model is engraved on ROPS plate.







## **CHAPTER - 2**

# **INTRODUCTION, WARRANTY & SAFETY**



# INTRODUCTION

## Tractor an Introduction

The word, 'Tractor' has been derived from 'Traction' which means pulling.

A Tractor is required to pull or haul an equipment or implement which are coupled to the Tractor body through suitable linkage. A Tractor can also be used as a prime mover as it has power outlet source which is also called Power Take off or PTO shaft.

In this manual the operating, maintenance and storage instructions for Solis-26 Tractor has been compiled. This material has been prepared in detail to help you in the better understanding of maintenance and efficient operation of the machine.

If you need any information not given in this manual or require the services of a trained mechanics, please get in touch with the ITL Dealer/Distributor in your country, Dealer/Distributors are kept informed of the latest methods of servicing Tractors. They keep stock of genuine spare parts which is supplied by the company.

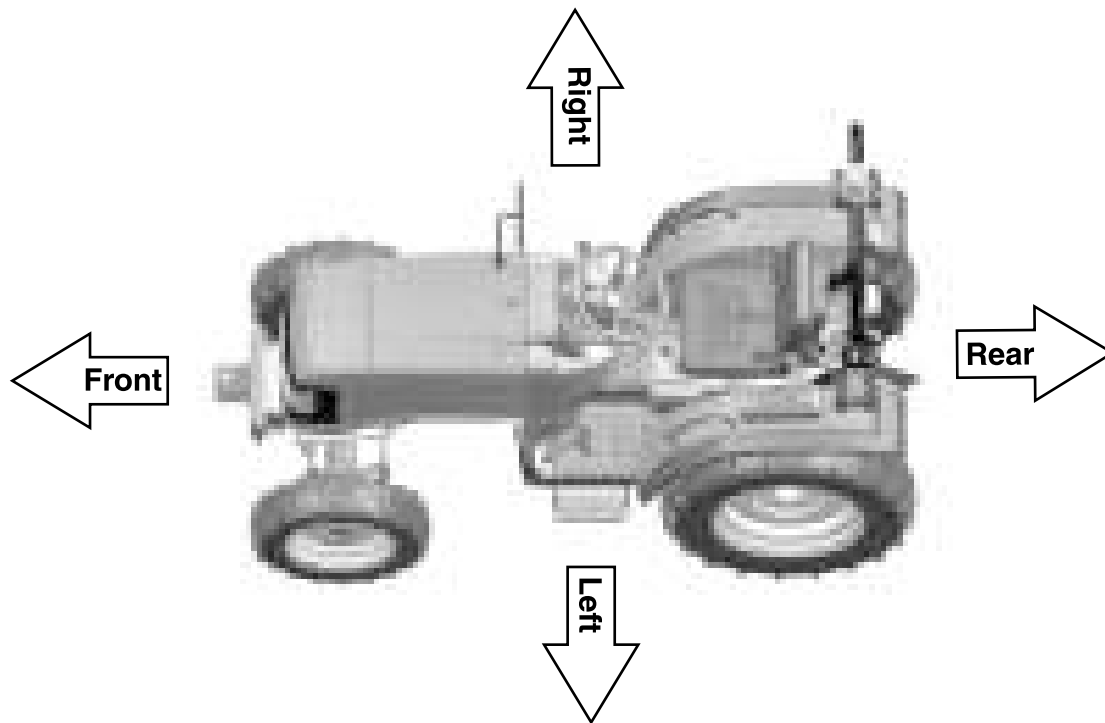

(Front, Rear, Left, Right Portion)

Through this manual. The use of the terms LEFT, RIGHT, FRONT and REAR must be understood, to avoid any confusion when following the introductions. The LEFT and RIGHT means left and right sides of the Tractor when facing forward in the driver's seat, Reference to the FRONT indicates the radiator end of the Tractor, while the REAR, indicates the drawbar end.

Always specify the tractor chassis and engine serial number when ordering spare parts. This will facilitate correct & faster delivery of require parts. For easy reference, we suggest you to write the number in the space provided in the owner's personal data.

# WARRANTY

## Warranty Policy

M/s International Tractors Limited, India warrant, subject as hereinafter provided that all new goods supplied by it are free from defects in material and workmanship. Its liability under such warranty being limited to 24 Months from date of Bill of landing or 18 Months from date of delivery to first original retail purchaser or 1500 Hours which ever is earlier. Warranty for proprietary items will be up to 12 months or 1000 working hours whichever appears earlier from the date of delivery to the first original retail purchaser. Claims will be settled against manufacturing defects by ITL as per their published warranty policy.

### (A) - Terms and Condition:

- ☞ During warranty period the Authorized Distributor will repair the Tractor by replacing the failed parts from their stock which are supplied by ITL against their order and lodge the claim within 60 days from the date of repair of Tractor.
- ☞ The claim will be settled as per ITL warranty policy.
- ☞ If any work is outsourced like welding, machining operation, transportation, labor charges etc will not be covered under warranty.

### (B) Exceptions To Warranty:

- ☞ Electrical fitment like Bulbs and Glasses do not come under warranty. At the time of delivery the customer should ensure that these things are in proper order because after that, customer himself is responsible.
- ☞ Policy does not include replacement of Oil and Fuel filters, Oil and Lubricants, Nuts & Bolts, Plastic Material.
- ☞ Warranty for propriety articles like Fuel Injection Equipments, Self starter, Alternator, Batteries, Tyres & Tube will be up to 12 months or 1000 working hours whichever appears earlier from date of sale to the original retail customer & shall be settled as per terms & conditions of the concerned manufacturer provided the repairable items have not been repaired from any other sources.
- ☞ Distributor will deliver the tractor with complete oil level as per standard onwards. In case of any seal leakage, customer will have to bear the cost of oil.
- ☞ Normal wear and tear of the components is not covered under warranty; however ITL will decide discuss premature or epidemic on case to case basis.
- ☞ Parts lost in field are not covered under warranty.

### Warranty is not applicable

- ☞ If tractor is being used overloaded or over heated, driver negligence, unauthorized modification, untimely servicing, poor maintenance or tractor met with an accident.
- ☞ Tractor has crossed the warranty period.
- ☞ In case of late submission of warranty claim. (The claim must be submitted within 60 days from the date of repair).
- ☞ If defective parts not available for inspection. ITL can request parts within 90 days from date of submission of warranty claims.
- ☞ Once a Tractor is purchased / delivered, it will not be returned or replaced. It will be repaired only as per ITL warranty policy.
- ☞ Warranty applicable only to first retail purchaser.
- ☞ This policy ceases if the components shows mishandling, modification, neglect of slight defect, overloading, overheating, poor maintenance or use of incorrect grade of oil.

# WARRANTY

- ☞ The warranty becomes void if the tractor is repaired/ dismantled in an unauthorized workshop and use of replacement parts, not supplied/approved by ITL.
- ☞ ITL's responsibility is limited to the terms of the warranty and it shall not be answerable for personal injuries or consequential or resulting liability, damage or loss arising from any defects.

## **(C) - Warranty Claims Submission: -**

Authorized Dealer will submit the warranty claim form by filling all column duly signed & seal by dealer with customer signature, along with following documents:

1. Photograph of failed component with Chassis/Engine number written with paint
2. Copy of Job card duly signed by dealer and customer.
3. Copy of Tractor Installation certificate//Delivery Certificate.

- ☞ Claims will not be entertained under warranty if received with incomplete information and without supporting documents.
- ☞ All warranty claims along with supporting documents must reach warranty department under intimation to Exports Department within 60 days from date of repair of Tractor thru courier/ e-mail.
- ☞ Distributor must provide the Installation certificate copy with in 30 days from the date the tractor is delivered to customer, for reference of ITL during warranty settlement. The claim of tractor for which installation certificate is not submitted, warranty claim shall not be settled.

## **(D) - Storage of Defective Parts: -**

- ☞ All failed parts pertaining to warranty replacement are property of ITL & must be retained with distributor at least for 90 days from date of submission of warranty claims with proper tagging & packing for further Inspection/investigation by ITL Engineer. These can be called back to ITL works if necessary for investigation at ITL expense.

## **(E) - Settlement of Warranty Claim: -**

- ☞ Claim will be settled with in 30 days from date of submission of warranty claim as per ITL warranty policy by our warranty division and reimbursement of parts value as per latest prices (applicable import price at the time of repair of tractor) + 35 % as freight component will be credited in Distributor account within 45 days of submission of warranty claim.

Address for submission of warranty claims: -

To,

Exports Department

INTERNATIONAL TRACTORS LTD,

Village - Chak Gujran,

P.O.- Piplanwala-146022.

Jalandhar Road,

HOSHIARPUR (Punjab), INDIA.

Tel No: +91-1882-302521

Fax No: +91-1882302523

E- Mail: exports@sonalika.com

# SAFETY NOTES

---

## Guidelines About Safety Sign

### Recognize Safety Information:

Any of the following symbols on your machine or in this manual, alert you to the potential for personal injury. Follow recommended precautions and safe operating practices.



The symbol and the word DANGER indicate an immediate hazardous situation, which if not avoided, will result in DEATH OR VERY SERIOUS INJURY.



The symbol and the word WARNING indicate a potentially hazardous situation. If the instructions or procedures are not correctly followed it could result in DEATH OR VERY SERIOUS INJURY.



The symbol and the word CAUTION indicate a potentially hazardous situation, which if not avoided, may result in MINOR INJURY.

**IMPORTANT :** Indicates that equipment or property damage could result if instructions are not followed.

**NOTE :** Indicates important information or information which is useful for tractor operation.

## SAFETY NOTES



### SAFE OPERATION

Careful operation is your best insurance against accident.

Read and understand this manual carefully before operating the tractor.

All operators no matter how much experience they may have, should read this and other related manuals before operating the tractor or any implement attached to it.

It is the owner's obligation to instruct all operators a safe operation.

### BEFORE OPERATING THE TRACTOR

#### READ SAFETY INSTRUCTION

Carefully read all safety instructions given in this manual for your safety. Tempering with any of the safety devices can cause serious injuries or death. Keep all safety signs in good condition. Replace missing or damaged safety signs.

Keep your tractor in proper condition and do not allow any unauthorized modifications to be carried out on the Tractor, which may impair the function/safety and affect Tractor life.

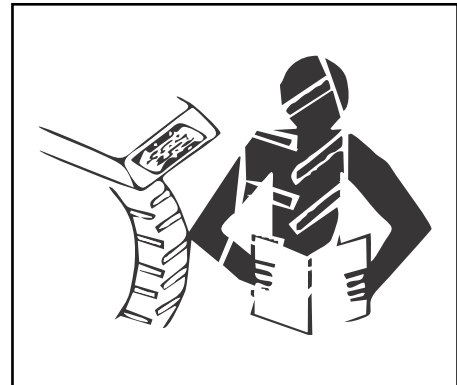

Strictly follow the instructions outlined in the operator's manual of the mounted or trailed machinery or trailer, and not to operate the combination tractor — machine or tractor — trailer unless all instructions have been followed.

### DRIVING THE TRACTOR

1. Watch where you are going especially at row ends, on roads, around trees and low hanging obstacles.
2. To avoid upsets, drive the tractor with care and at speeds compatible with safety, especially when operating over rough ground, crossing ditches or slopes, and when turning at corners.
3. Lock the tractor brake pedals together when transporting on roads to provide proper wheel braking.
4. Keep the tractor in the same gear when going downhill as used when going uphill. Do not coast or free wheel down hills.
5. Any towed vehicle and/or trailer whose total weight exceeds that of the towing tractor, must be equipped with its own brakes for safe operation.
6. When the tractor is stuck or tyres are frozen to the ground, back out to prevent upset.
7. Always check overhead clearance, especially when transporting the tractor.

# SAFETY NOTES

## STARTING THE TRACTOR

### Warn bystanders before starting:

Before starting, Walk all around the tractor and any attached equipment. Make sure that no one is under it, on it, or close to it. Let other workers and bystanders know you are starting up and don't start until everyone is clear of the tractor, implements and towed equipment.

Ensure that all bystanders, particularly children are in a safe position before starting the engine.

### Mount and dismount properly:

Always use 'three point contact' with the machine, and face the machine when you mount it. Three point contact means both hands and one foot or one hand and both feet are in contact with the machine at all times during mounting and dismounting.

Clean the soles of your shoes and wipe your hands before climbing on. Use handrails, grip handrails, ladders or steps (as provided) when mounting or dismounting.

NEVER use control levers as a hand hold and NEVER step on foot controls when mounting or dismounting.

NEVER attempt to mount or dismount from a moving tractor. NEVER jump off a tractor in any circumstances.

Adjust the seat, fasten the seat belt (where applicable as outlined in this manual), apply the parking brake and put all controls in neutral before starting up.



Before starting the engine, make sure there is plenty of ventilation. Never operate the engine in a closed building. The exhaust fumes may cause asphyxiation.



## KEEP RIDERS OFF TRACTOR

Do not allow riders on the Tractor.

Riders on Tractor are subject to injury such as being stuck by foreign objects and being thrown off the Tractor.

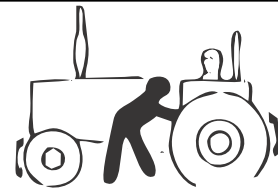

## PRECAUTION TO AVOID TIPPING

Do not drive where the Tractor could slip or tip.

Stay alert for holes and rocks in the terrain, and other hidden hazards.

Slow down before you make a sharp turn.

Driving forward out of a ditch or mired condition could cause Tractor to tip over backward. Back out these situations if possible.

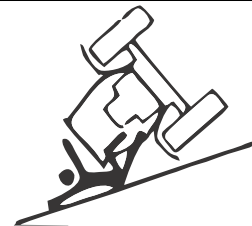



## SAFETY NOTES

### PROHIBITED USE OF TRACTOR DURING OVERTURNING

#### Risk of Overturning:

For your safety, tractor is fitted with safety frame and seat belts.

In the event of overturning with a tractor fitted with a safety frame, hold the steering wheel firmly and DO NOT attempt to leave the seat until the tractor has come to rest.

#### To avoid side overturns:

- Set the wheel track at the widest setting suitable for the job being done.
- Lock the brake pedals together before driving at transport speeds.
- Reduce speed to match operating conditions. If the tractor is equipped with a front end loader, carry the bucket and load as low as possible.
- Make wide slow turns on reduced speed. DON'T let your tractor bounce. You may lose steering control.
- DON'T pull a load too heavy for your tractor. It could run away on the down slope the tractor could jack knife around a towed load.
- DON'T brake suddenly. Apply brakes smoothly and gradually.
- When going down a slope use the throttle to slow the tractor engine and use the same gear you would use to up the slope. Shift into gear before you start downhill.
- Engine four-wheel drive (4WD), if fitted, will give you four wheel braking.

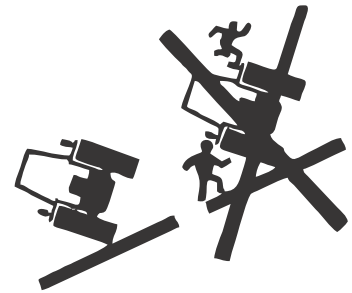

### PARK TRACTOR SAFELY

Before working on the Tractor:

Lower all equipments to the ground.

Stop the engine and remove the ignition key.

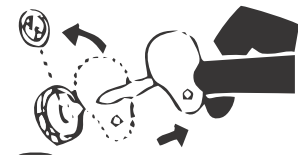

### SAFETY STARTER SWITCH

1. Clutch operated Safety switch is provided which allows the starting system to become operational only when the Clutch pedal is fully pressed.
2. Do not By-pass this Safety switch or work on it. Only Authorized Dealers are recommended to work on Safety starter switch.

### TRACTOR RUNAWAY

1. The tractor can start even if the transmission is engaged position causing Tractor to runaway and serious injury to the people standing nearby the tractor.
2. Keep Transmission in neutral position. Foot brake engaged and PTO lever in disengaged position while attending to Safety Starter Switch or any other work on the Tractor.

## SAFETY NOTES

### AVOID HOT EXHAUST

Servicing machine or attachment with engine running can result in serious personal injury. Avoid exposure.

Exhaust parts and streams become very hot during operation. Exhaust gases and components reach temperatures hot enough to burn people, ignite, or melt common materials.



### AVOID HIGH-PRESSURE FLUIDS

Escaping fluid under pressure can penetrate the skin causing serious injury. Keep hands and body away from pinholes and nozzles, which eject fluids under high pressure. If any fluid is injected into the skin, consult your doctor immediately.

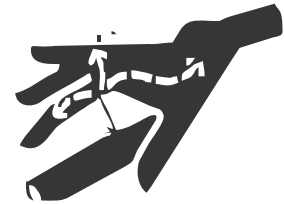

### PREVENT BATTERY EXPLOSIONS

Keep sparks, lighted matches, and open flame away from the top of battery.

Battery gas can explode.

Never check battery charge by placing a metal object across the poles.



### ALWAYS USE SAFETY LIGHTS

Use of hazard warning lights and turn signals are recommended when towing equipment on public roads unless prohibited by state or local regulations.



### ROAD REGULATIONS

- When operating your tractor on a public road a number of precautions must be taken.
- Know the route you are going to travel.
- Use caution when towing a load at transport speeds especially if the towed equipment is NOT equipped with brakes.
- Observe all local or national regulations regarding the road speed of your tractor.
- Use extreme caution when transporting on snow-covered or slippery roads.
- Wait for traffic to clear before entering a public road. Beware of blind intersections. Slow down until you have a clear view.



## SAFETY NOTES

### PREVENT ACID BURNS

Sulfuric acid in battery electrolyte is poisonous. It is strong enough to burn skin, cause holes in clothing and cause blindness. For adequate safety always:

1. Fill batteries in a well-ventilated area.
2. Wear eye protection and acid proof hand gloves.
3. Avoid breathing direct fumes when electrolyte is added.
4. Do not add water to electrolyte as it may splash off causing severe burns.

If you spill acid on yourself, immediately flush your skin with water and flush your eyes for 10-15 minutes. Get medical attention immediately.

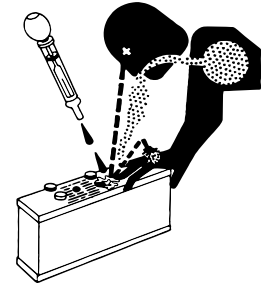

### HANDLE FUEL SAFELY-AVOID FIRES

Handle fuel with care; it is highly flammable. Do not refuel the Tractor while smoking or near open flame or sparks.

Always stop engine before refueling.

Always keep your tractor clean of accumulated grease and debris.

Always clean up spilled fuel.



### SERVICE TRACTOR SAFELY

Do not wear a necktie, scarf or loose clothing when you work near moving parts. If these items get caught, severe injury could result.

Remove rings and other jewellery to prevent electrical shorts and entanglement in moving parts.

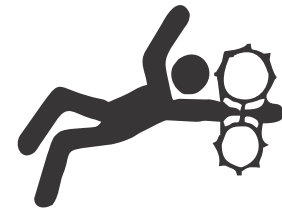

### STAY CLEAR OF ROTATING SHAFTS

Entanglement in rotating shaft can cause serious injury or death.

Keep PTO shield in place at all times.

Wear close fitting clothing. Stop the engine and to sure PTO drive is stopped before making adjustments, connections, or cleaning out PTO driven equipment.



### GENERAL OPERATING HAZARDS

- Three point hitch and side mounted implements make a much larger arc when turning that towed equipment. Make certain to maintain sufficient clearance for safe turning.
- When using attachments or implements with the tractor, be sure to thoroughly read the Operator Instruction Book for that attachment or implement and follow its safety instructions.
- Pull only from the approved drawbar. Towing or attaching to other locations may cause the tractor to overturn.
- Improper use of the drawbar, even if correctly positioned, may cause the tractor to overturn to the back.
- DO NOT overload an attachment or towed equipment. Use proper counterweights to maintain tractor stability. Hitch loads to the drawbar only.

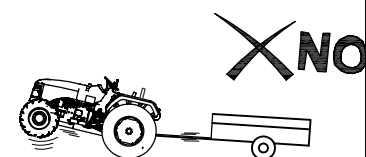
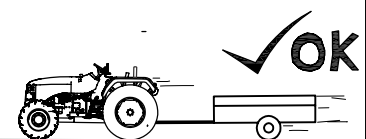

## SAFETY NOTES

### PRACTICE SAFE MAINTENANCE

- Understand service procedure before doing work.
- Keep the surrounding area of the Tractor clean and dry.
- Do not attempt to service Tractor when it is motion.
- Keep body and clothing away from rotating shafts.
- Always lower equipment to the ground. Stop the engine.
- Remove the key equipment to the ground. Stop the engine.
- Securely support any Tractor elements that must be raised for service work.
- Keep all parts in good condition and properly installed.
- Replace worn or broken parts. Replace damage/missing decals.
- Remove any buildup of grease or oil form the Tractor.
- Disconnect battery ground cable (-) before making adjustments on electrical system or welding on Tractor.



### SAFETY TIPS DURING MAINTENANCE

1. At least on a daily check all oil levels. Water level in the radiator and electrolyte level in the battery and perform services according to the service schedule.
2. Ensure tyre pressure are even and the correct pressure for the job being done is maintained.
3. Check to ensure that the all controls and preventive mechanisms of the Tractor and implement work correctly and effectively.
4. Ensure that an adequate set of the correct tools is available for maintenance and minor repairs.
5. Ensure that all service work and repairs are carried out on a flat area with a concrete or similar floor.  
Do not carry out service work on tractor until it is switched off, and the parking brake applied and wheels chocked. Where a tractor is staired in a confined area, ensure that the area is well ventilated as exhaust gases are very harmful, and can cause death.
6. Do not work under lifted implements/Implements under operation.
7. When changing wheels or tires ensure that a suitable wheel stand is placed under the axle prior to removing the wheel and the wheels are chocked.
8. Where guards or shields need to be removed to perform a service or repair, ensure that the guard or shield is correctly reinstalled before starting the Tractor.
9. Never refuel near a naked flame or with an overheated engine. Ensure to turn off Engine before refueling.
10. The cooling system operates under pressure, take care when removing the Radiator cap a hot engine to prevent being scalded by steam or hot water. Do not add water in the radiator when then engine is hot. Add water to the radiator only after the engine cools down completely.
11. To prevent fire keep the tractor including the engine clean and free from inflammable material and well away from fuels and other inflammable material.

## SAFETY NOTES

### Safety: Prepare For Safe Operation

#### Protect yourself:

Wear all the protective clothing and personal safety devices issued to you or called for by job conditions. Don't take risk hence you may carry/wear the following (Fig. 2.1)

- (a) A hard hat.
- (b) Safety glasses, goggles or face shield.
- (c) Hearing protection.
- (d) Respirator or filter mask.
- (e) Inclement weather clothing.
- (f) Reflective clothing.
- (g) Heavy gloves (neoprene for chemical, leather for rough work).
- (h) Safety shoes.

DO NOT wear loose clothing, jewellery or other items and tie up long hair which could catch on controls or other parts of the tractor.

Learn where fire extinguishers and first aid or emergency equipment is kept and where to get help in a hurry. Make sure you know how to use this equipment.



(a)



(b)



(c)



(d)



(e)



(f)

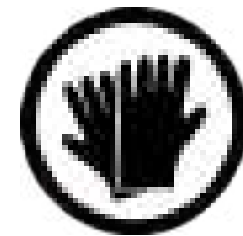

(g)



(h)

#### Protect The Environment :

It is illegal to pollute drains, water courses or soil. Use authorized waste disposal facilities, including civic amenity sites and garages providing facilities for disposal of used oil. If in doubt, contact your local authority for advice.

To get to know the correct methods to dispose of oils, filters, tyres etc. contact your Dealer or the local agency for waste recycling.



## **CHAPTER - 3**

# **INSTRUMENTS & CONTROLS**













# INSTRUMENTS & CONTROLS

## Universal Symbols

As a guide to the operation of your tractor, various universal symbols have been utilized on the instruments and controls and at other locations of the tractor. The symbols are shown below with an indication of their meaning.

	Safety Alert Symbol		Fast
	Fuel Level		Slow
	Engine Rotational Speed		Engine Coolant-Temperature
	Parking Brake		
	Air Cleaner Clogging Sensor		
	Battery Charging Condition		
	Engine Oil-Pressure		
	Turn Signal		
	Power Take-Off Clutch Control-Off Position		
	Power Take-Off Clutch Control-On Position		
	Differential Lock		
	Hazard Warning Lights		
	Master Lighting Switch		
	Parking Brake Indication		
	Headlight-Low Beam		
	Headlight-High Beam		
	Audible Warning Device		
	Four-Wheel Drive-On		
	Four-Wheel Drive-Off		

# INSTRUMENTS & CONTROLS

## Tractor Controls

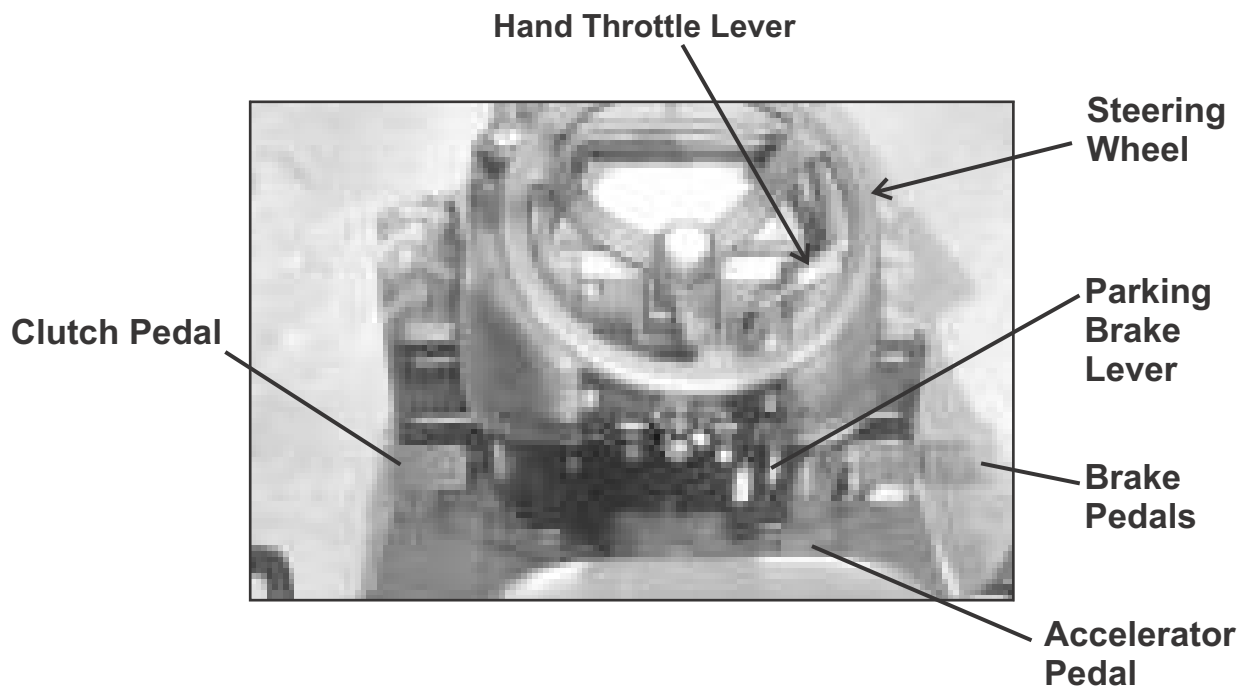
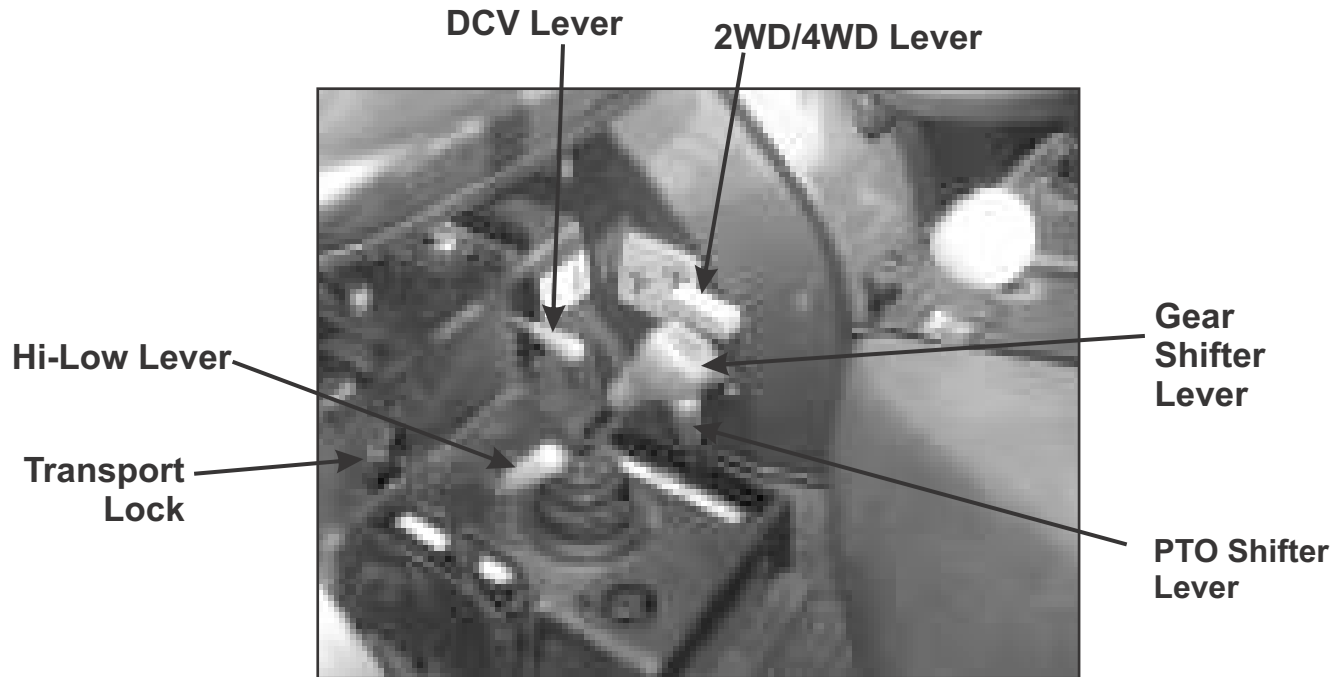

# INSTRUMENTS & CONTROLS

## 3.1 Instrument Panel

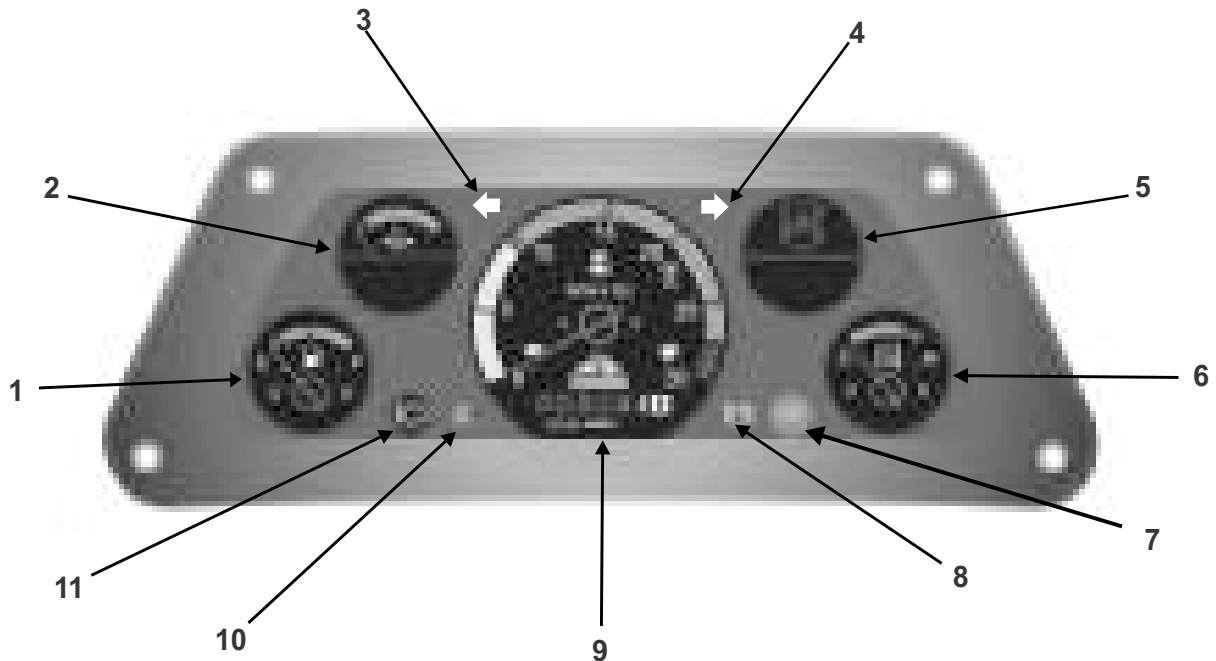

- 1 Fuel Gauge
- 2 Engine Oil Pressure Gauge
- 3 Left Turn Indicator
- 4 Right Turn Indicator
- 5 Gear Lever Position Indicator
- 6 Temperature Gauge
- 7 Cold Start Indicator
- 8 Battery Charging Indicator
- 9 Engine RPM cum Hour Meter
- 10 Air Cleaner Clogging Indicator
- 11 High/Low Beam Indicator

## INSTRUMENTS & CONTROLS

### Fuel Gauge

Fuel gauge gives an approximate indication of the quantity of fuel in fuel tank. If the needle enters in RED zone, refill the fuel tank.

Ensure Min. 5 Ltr. of Fuel in Fuel Tank to avoid air locking.

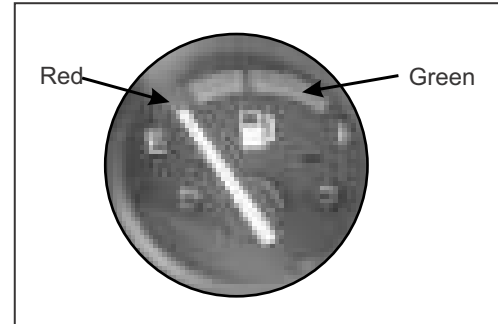

### Engine Oil Pressure Gauge

Oil Pressure Gauge indicates pressure of lubricating oil in the engine. If the needle goes in red zone, stop the engine and follow the procedure :

1. Stop your tractor to the side of road on leveled surface.
2. Wait for sufficient time after stopping the engine to get down the oil from gallery to oil sump.
3. Pull out the dipstick, wipe off oil with a clean cloth.
4. Insert the dipstick, fully into the oil level gauge guide, then pull out the gauge again. The correct oil level is between the Max. & Min. marks on the dipstick.
5. If the oil level is low, remove the oil filler cap and add recommended oil up to the Max. level.
6. Install the oil filler cap after top up.
7. Check the oil pan and other parts for oil leakage.
8. Start the engine, allow it to run idle and don't accelerate engine immediately if again, the needle goes into red zone, then contact your nearest dealer.

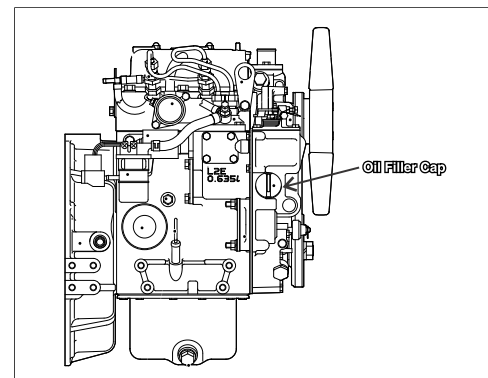
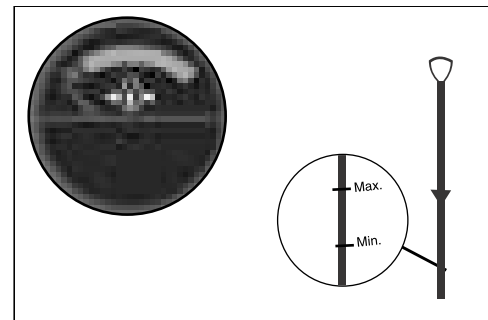

**IMPORTANT:** Do not operate the engine if there is no oil pressure indication. This may damage engine parts.

### Left Turn Indicator

It glows when the left side indicator is switched ON.

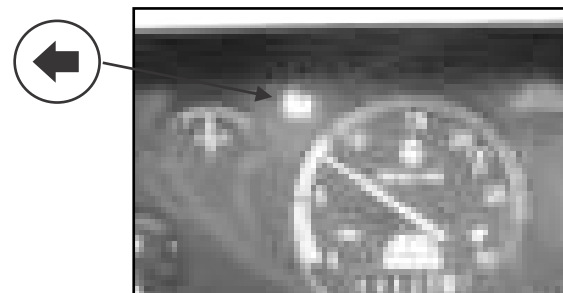

## INSTRUMENTS & CONTROLS

### Right Turn Indicator

It glows when the right side indicator is switched ON.

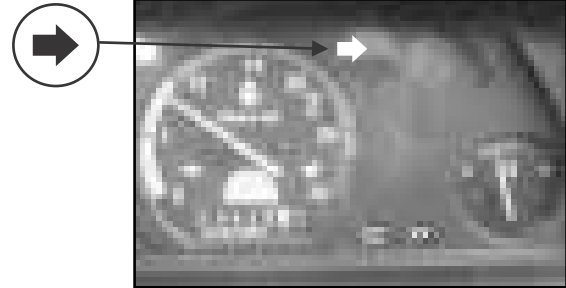

### Gear Lever Position Indicator

This is only for awareness about Positions of Gear Lever to select the desired gear.

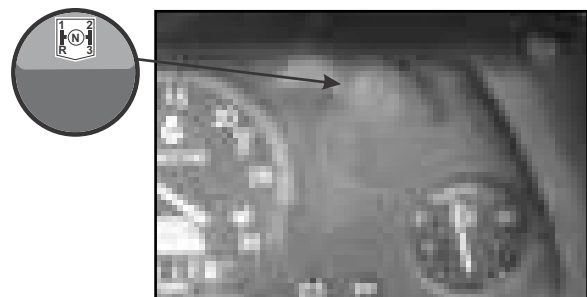

### Temperature Gauge:

This gauge indicates temperature of engine coolant, GREEN zone indicates normal temperature and RED zone indicates engine overheating. If the needle moves beyond normal range, towards RED zone, follow the procedure:

1. Drive safely to the side of road and stop your tractor.
2. Allow the engine to run idle.
3. If the temperature does not go down, shut it off and allow sufficient time for it to cool.
4. Visually inspect the fan belt for looseness, breakage and all water hose connections for leak.
5. If the fan belt is OK and no coolant leak is noticed check the coolant level.
6. Add coolant if required otherwise contact your nearest dealer.

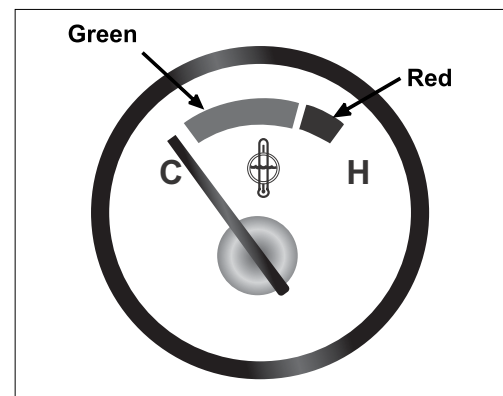

**WARNING**

Do not remove the radiator cap when the engine and radiator are hot. Hot coolant and steam may blow out under pressure, which could cause serious injury. The cap should only be taken off when the coolant temperature has lowered.

Necessary precaution to be taken while opening the radiator cap.

# INSTRUMENTS & CONTROLS

## Cold Start Indication

It glows when ignition heater is ON at second position of the starting key.

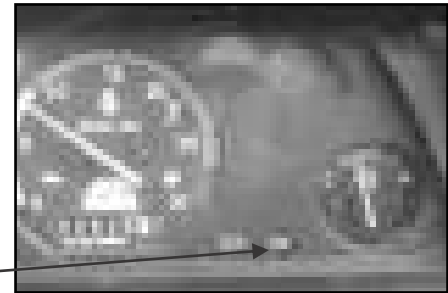

## Battery Charge Indicator

This indicator indicates that either battery is being charged or not. Refer the below given observations with respect to different

CONDITIONS			Battery Charging System Functioning
IGNITION SWITCH	ENGINE	INDICATOR	
ON	OFF	GLOW	OK
ON	OFF	OFF	Charging System/Battery is defective, Get both thing checked from electrician
ON	Start/Running	OFF	Battery being Charged
ON	Start/Running	GLOW	Charging System is defective/Battery is draining out, get the charging system checked from electrician.

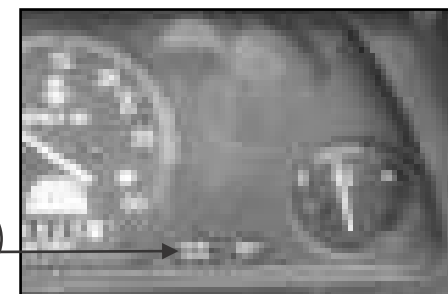

## Engine RPM cum Hour Meter

Needle of this meter indicates speed of engine in revolution per minute and the hour meter indicates the number of hours worked by the engine.

Green Zones is safe for operation.

**NOTE:** Hour meter may be defer from actual hour (As per Clock) this is purely depend on Engine RPM.

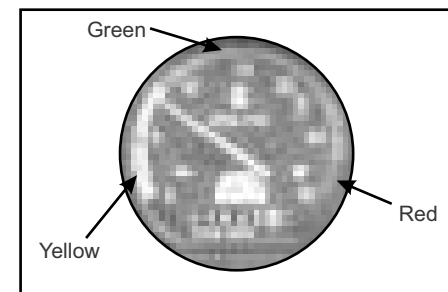

## Air Cleaner Clogging Indicator

This light will glow when the air filter get choked. Clean the air cleaner element immediately with air pressure if this light is glowing.

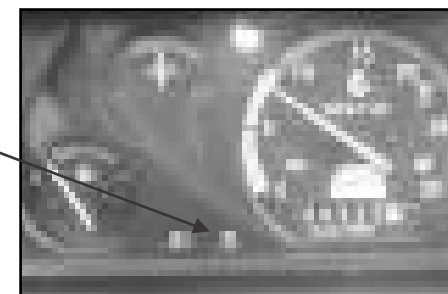

## High Beam Indicator

This light glows when Head Lights are in high beam mode.

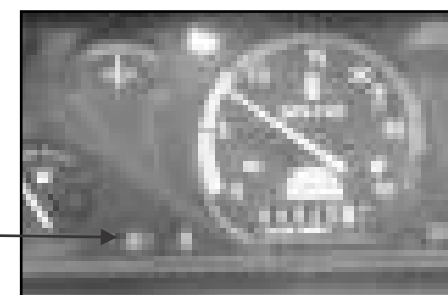

# INSTRUMENTS & CONTROLS

## 3.2 Dashboard Controls

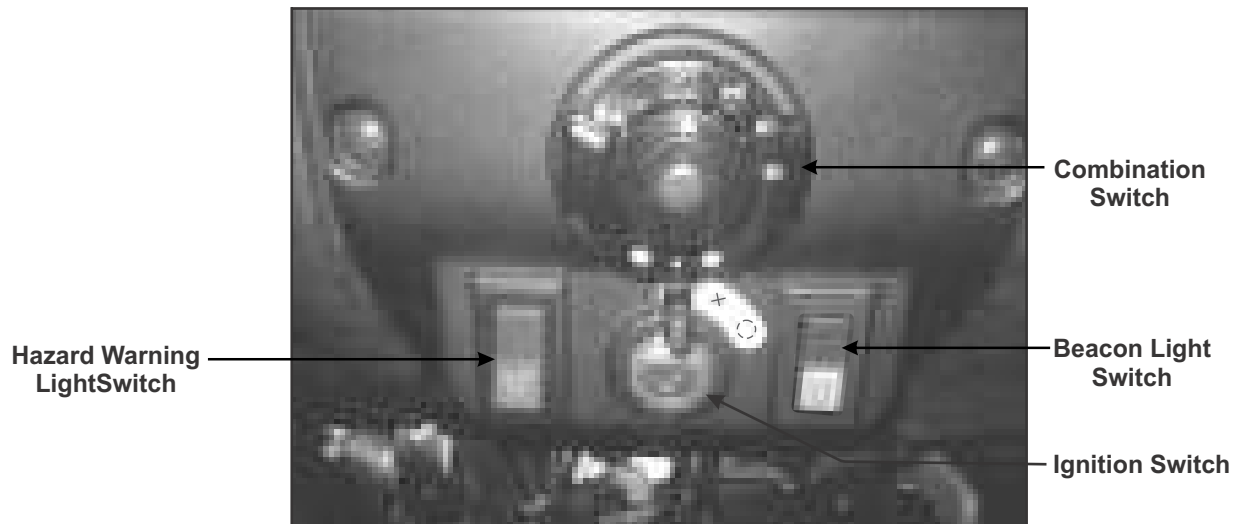

### Hazard Warning Light Switch:

Purpose of the hazard switch is as follows.

1. All the four lights blinking, indicates that driver has no control on tractor.
2. Mechanical defects in the tractor.  
Push this switch to blink all indicators in HAZARD situation to alert others.



### COMBINATION SWITCH:

#### Side Indicator Switch (A):

This switch is used for indicating the vehicle turn. Move turn signal lever left to indicate left (L) hand turn or right (R) for right hand turn. Indicator lights will flash according.

#### Horn Switch (B):

Press this switch to blow the Horn.

#### Head Light and Parking Light Switch (C):

This switch illuminates all lights (Parking Light, Head Light, High Beam, Low Beam) with the clockwise rotation.

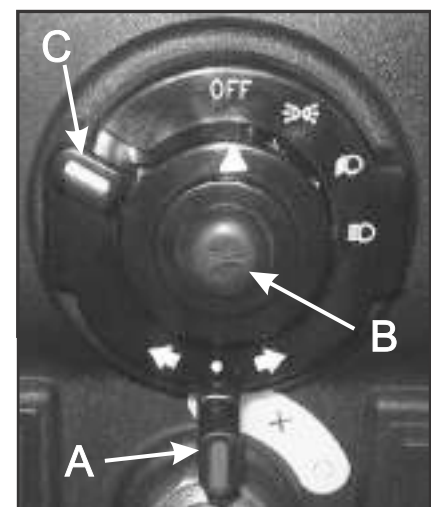

# INSTRUMENTS & CONTROLS

<p><b>OFF Position</b> All lights are off.</p>	<p><b>1st Position (Clockwise)</b> With 1st click Stop parking lights, Instrument panel lights and tail lights will glow.</p>	<p><b>2nd Position (Clockwise) :</b> With 2nd click Stop Head lights (Low beam), Instrument panel lights, Parking lights and tail light will glow</p>	<p><b>3rd Position (Clockwise) :</b> With 3rd click Stop Head lights (High beam) Instrument panel lights, Parking lights and tail light will glow.</p>	<p><b>Horn :</b> Press the combination switch to blow the Horn.</p>
--	---	---	--	---

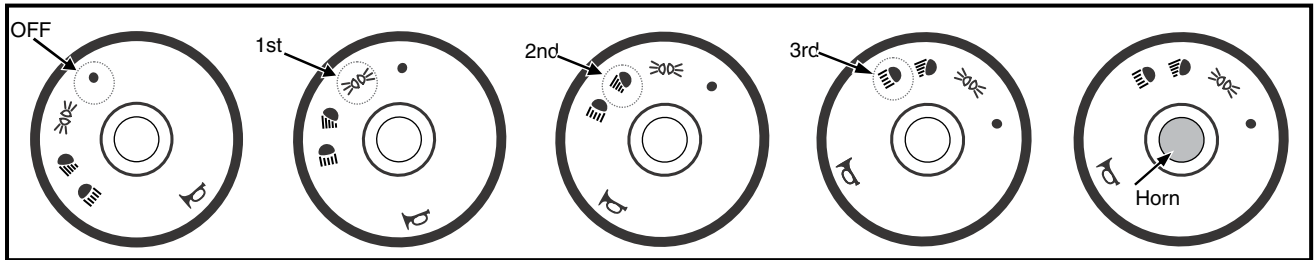

## Starting Key (Ignition) Switch:

Functioning of starting key switch is as below:

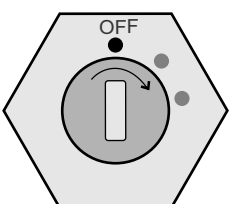
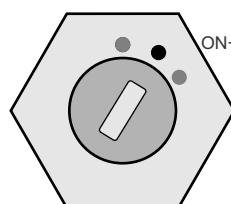
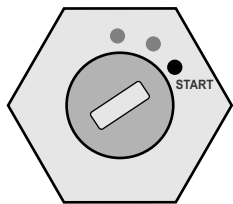
<p><b>1st Position (OFF) :</b> All the electrical systems remain disconnected in this position.</p> 	<p><b>2nd Position (ON &amp; COLD START) :</b> The warning lights (Battery, Oil Pressure indicator) will be functional in this position. This is normal running position after the engine is started. Glow plug indication in instrument cluster will glow at this position.</p> 	<p><b>3rd Position (START):</b> Immediate after the use of air heater turn the key further clockwise to Start position to start the engine.</p> 
---	--	---

**NOTE :**

- Do not keep the starter engaged more than 5-8 seconds. If engine stalls/fails to start then wait for 5-10 seconds before re-engaging the starter, otherwise you may damage it.
- Keep the switch in OFF condition when engine is also in OFF condition.

## Beacon Light Switch

This switch is used to ON/OFF the Beacon Light (Revolving Light) mounted on ROPS.

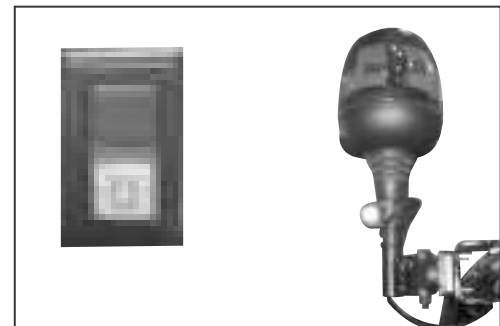



## INSTRUMENTS & CONTROLS

### Fuse Box:

Fuse box is mounted ahead right side of Fuel Tank. If an electrical failure occurs, check and rectify the problem and then replace the blown up fuse with genuine fuse of specified rating.



Never install a wire instead for proper fuse.



### Lights

Tractor is equipped with E marked head and tail lights.

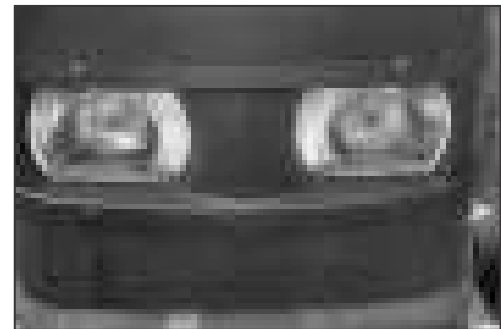

Headlights



Tail Lights

### Plough Lamp

Adjustable plough lamp (A) is provided at rear right side and it is mounted on Registration plate.



## INSTRUMENTS & CONTROLS

### Beacon Light

To be used according to your country's regulation. This light is detachable type and can be removed based on requirements.

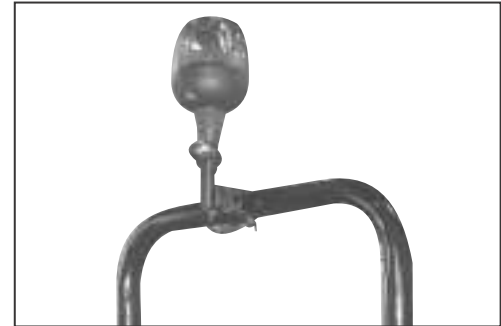

### Driver's Seat

While seating, adjust the wt of operator with wt adjustment knob provided at back side of seat so as to be comfortable driving & to minimise vibrations.

With the fore & aft adjusting knob, slide the seat so as to have a comfortable approach towards all levers. The range of effort that can be adjusted while sitting on seat is 50-140 kgf.

#### Horizontal Adjustment

- Lift the lever (1) to move the seat forward and backward.

#### Vertical Adjustment

- Use knob (2) to adjust the suspension.
- Use knob (3) to adjust the height of the seat vertically.
- Seat belt (4) for safety.



#### To avoid personal injury

- Make adjustments to the seat only while the tractor is stopped.
- Make sure that the seat is completely secured after each adjustment.
- Do not allow any person other than the operator to ride on the tractor.
- Always use the seat belt when the ROPS is installed.
- Do not use the seat belt if the tractor is not equipped with ROPS.

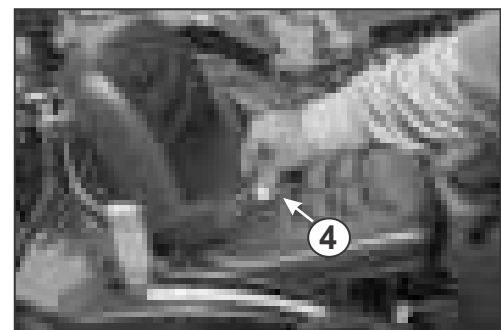
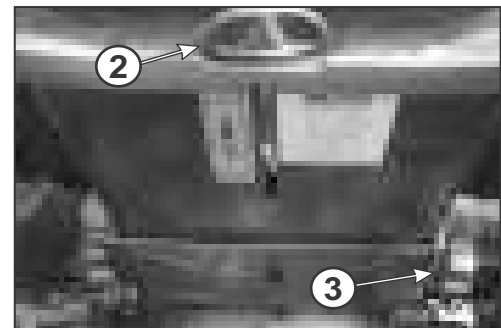

# INSTRUMENTS & CONTROLS

## Registration Plate

A vehicle registration plate (A) or number plate is mounted at rear end of the tractor as shown in Figure.

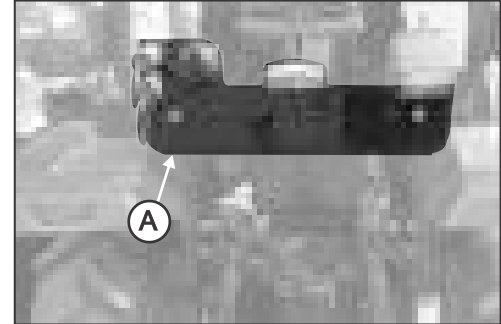

## Seven Pin Socket

7 Pin socket (B) is mounted on licence plate to attach the trailer connections:

Details of connectors is given under:

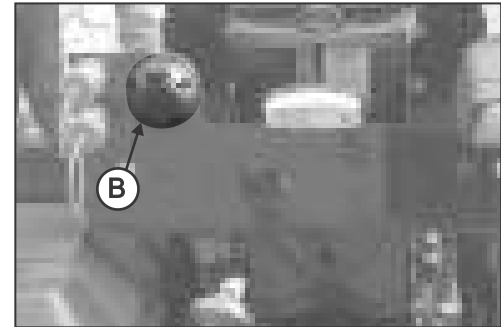

PIN No	Used for	Wire Colour Code
PIN1	Left Turn Signal	Green/Blue (G/L)
PIN2	Not in Use	-
PIN3	Earth	Black (B) or White (W)
PIN4	Right Turn Signal	Green/Red (G/R)
PIN5	Right Parking Light	Red (R)
PIN6	Brake Light	Green/Black (G/B)
PIN7	Left Parking Light	Red/Green (R/G)

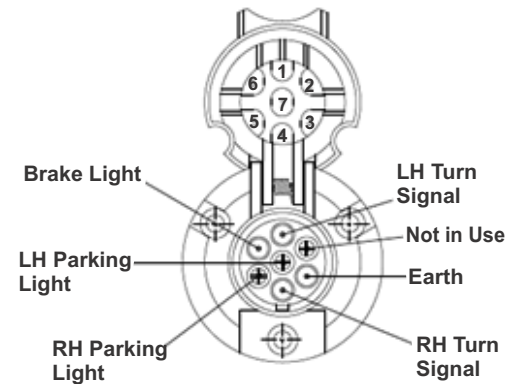

**7 Pin Socket (A)**

## Tool Box

Tool box (A) is mounted on left side fender.

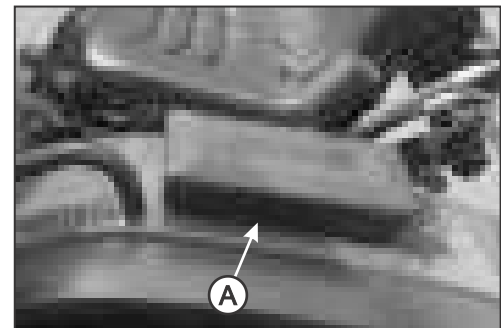



## **CHAPTER - 4**

# **OPERATION**



# OPERATION

## Boarding the Tractor

Always board the tractor from left hand side where a footrest is provided while taking care the other part of body must not foul with levers. This will provide ease to operator.

## Leaving the Tractor

After stopping the tractor, leave the tractor from LH or RH side of tractor.

## Engine:

### Starting the Engine (Having 3 Positions Switch):

Starting Key Switch: Starting Key switch is used to start the engine

#### 1. OFF POSITION

When the key is turned to this position, power supply to the electric circuits is cut off, and the key can be removed or inserted in this position.

**2. ON:** When the key is turned in to this position, power is supplied to the electric circuits. After the engine starts, the key is held in this position.

**& HEAT:** This is an intermediate position between the 'ON' and 'Start' position. When the key is turned to this position, the glow plugs would become hot and allow easy startup of a cold engine.

**3. START:** When the key is turned to this final position, the starter cranks the engine and the engine starts. When the key is released, it automatically returns to the 'ON' position.

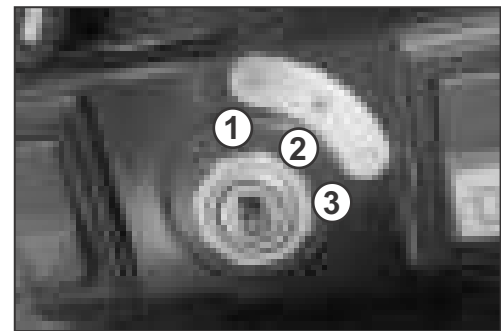

### For Starting:-

- A Check that the gear shifter lever is in neutral.
- B Move the low/ high speed selector lever to neutral position.
- C Tractor is equipped with clutch safety switch, always press the clutch pedal fully before starting the engine.
- D Check that PTO lever is in neutral.
- E Release the hand brake (if engaged).

## Cold Weather Starting (Temperature below 0 °C or 32° F):

### Proceed as Follows:

- 1 Perform operations A to E as instructed above.
- 2 Turn the Starter Key to 'Heat' position and keep it there for few seconds and then turn the key to start position.
- 3 If the engine fails to start repeat Step 2, wait for further 5 to 10 seconds and then turn the key to start position again.

### Note:

- 1 If the engine fails to start after two or three attempts and smoke can be seen coming out of the exhaust, repeat

## OPERATION

- the starting procedure with less time glow plug heater.
- 2 Do not keep the key turned to start position for more than 5-8 seconds at a time.
  - 3 Wait at least one minute after every two failed attempts of starting the tractor.

### Instructions:

1. The value of the noise at the operator's ear, measured according to Directive 2009/76/EC (1) of the European Parliament and of the Council and the noise of the tractor in motion measured according to Annex VI to Directive 2009/63/EC (2) of the European Parliament and of the Council: Operator ear level: 85.5dB Noise when tractor in motion, at By standard level: 82dB.
2. The value of the vibration level measured according to Council Directive 78/764/EEC (3) is less than 1.25 m/s<sup>2</sup>.

If the engine does not start regularly and easily, do not continue as for you may run down the battery. Bleed any air that may have accumulated in the fuel system and, if the problem persists check that:

- 1 Fuel filters are not blocked
- 2 The battery and Heater plugs are working efficiently.

**Note-:** Before starting a cold engine in cold weather first cover the radiator with a radiator cover. Remove the cover as soon as a normal working temperature is achieved.

### Running in

It is essential to take the following precautions during the running in period:

- 1 During this period, do not subject the tractor to loads greater than those it will have to deal with during the rest of its working life.
- 2 Engage low gears when towing heavy loads.
- 3 When running in, check regularly that all screws, nuts and bolts are tight.
- 4 To ensure prolonged clutch life, run in the clutch discs correctly.

### Turning off the engine:

- 1 Turn the engine accelerator to idle position.
- 2 Stop the engine by turning the starting Key to 'Off' position.

**IMPORTANT:** When outdoor temperature drops to around or below 0°C (32°F), check the cooling system and if necessary add the recommended antifreeze.

**IMPORTANT:** Do not inject fluids (ether) to make the engine easier to start in cold weather. The tractor is equipped with a cold start device.



## OPERATION

### Under Hood Muffler

Under hood muffler fitted inside the bonnet for better aesthetics, vision and better sound muffing capabilities.

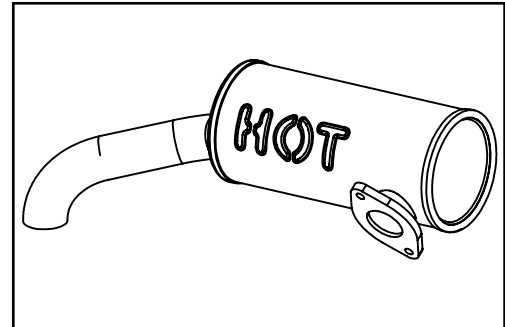

### Opening the Bonnet

Press the knob at center of bonnet towards steering wheel side with one hand (as shown) & with another hand, lift the bonnet from lower side (as shown).

### Closing of Bonnet

Gently lower the bonnet down, then press until lock is engaged.

**Note:** Do not use RVM holder as a support to open or close the bonnet, it may damage the mounting of RVM on bonnet.

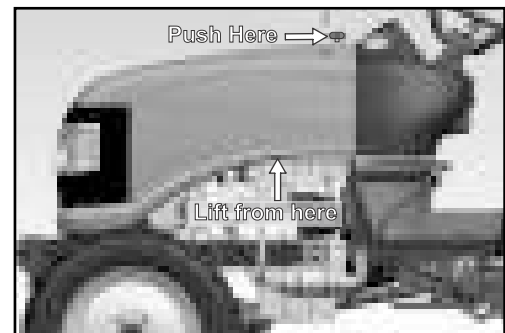

### Accelerator Pedal (A)

The accelerator pedal can override the setting of hand throttle lever to accelerate the engine.

However, when you release the pedal, the engine returns to the speed set by the hand lever. When using the accelerator pedal, always set the hand throttle lever to idling position.

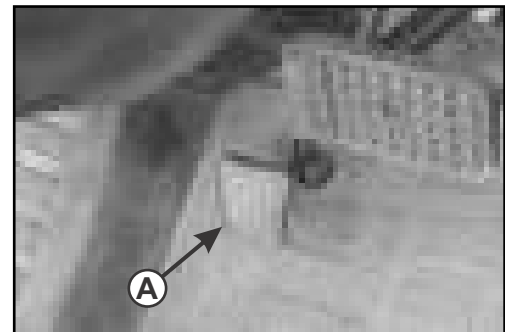

### Clutch Pedal (B)

Pedal released = Drive engaged.

Pedal Pressed = Drive disengaged.

Select lower gear as per load condition and don't over ride the clutch for acceleration.

**IMPORTANT:** Never keep your foot resting on clutch pedal when driving.

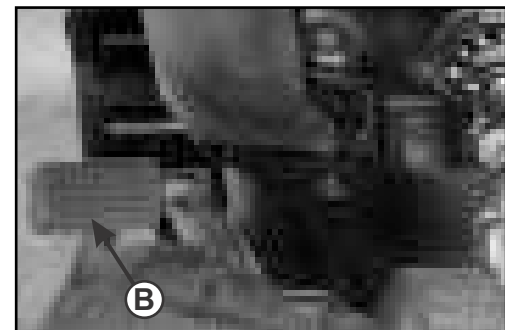

Never coast down slopes with the gear lever in neutral / clutch pressed when in gear.

## OPERATION

### 2WD / 4WD Lever (C)

You can drive the tractor in both 2WD or 4WD mode. Select the driving mode by Lever (A) as shown in figure.

**2WD MODE:** By engaging the lever in 2WD position the power is transmitted to rear wheels only. Pull the lever upward to select 2WD mode.

**4WD MODE:** With the lever in 4WD position the power is simultaneously transmitted to all 4 wheels (Front & Rear) of tractor. Push the lever downward to select 4WD mode.

**NOTE:** 4WD Mode is for field operation and 2WD mode is for road operation.

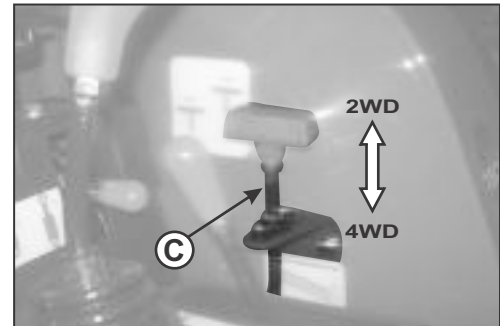

### Hand Throttle Lever (D)

Hand throttle lever mounted on front panel is used in field application. To increase the speed of engine, pull down the lever and to decrease, pull up the lever.

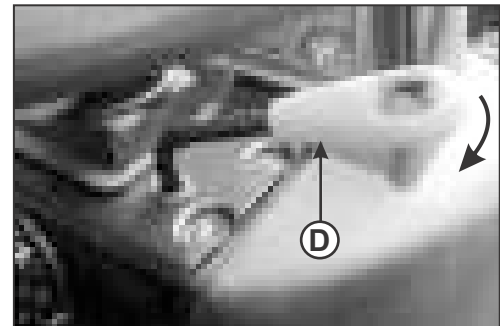

### Gear Shifter Lever

Gear shifter lever enables to get the required speed (6 Forward and 2 Reverse) by selecting the particular gear with combination of hi-low gear lever.

Before changing the tractor movement from forward to reverse or reserve to forward direction wait for the tractor to stop.

Release accelerator pedal and press the clutch pedal. Select required gear, release the clutch gradually and accelerate the engine.

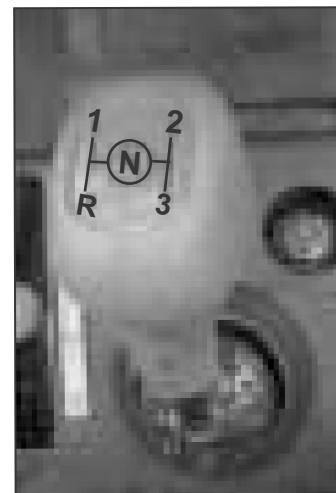

When traveling downhill always remain in gear. Never press clutch pedal. The gear selected should be same as used to climb up.

**IMPORTANT:** For engaging/disengaging gear always use the clutch.

# OPERATION

## Power Take off (PTO)

Power take off is mounted at rear side of tractor. This is used for supplying power directly to implement from engine. Power take off shaft has standard 06 Spline on 540 rpm. PTO can be engaged or disengaged by PTO shifter lever. Three speeds can be obtained by putting the PTO Lever in 3 different Position (i.e. 1, 2 and 3).

Position	PTO Speed	Engine RPM
1	540	2080
2	540E	1410
3	1000	1515

**IMPORTANT** : When PTO is not operational protect PTO splines with PTO Cap (A).

PTO Cap protects persons from injuries and the shaft splines from damage.

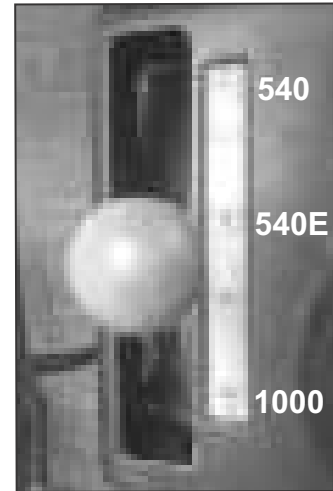

WARNING

Before connecting adjusting or working on implements operated by the PTO, disengage the PTO, stop the engine, remove the key from the dashboard and engage the parking brake. Do not work under raised implements.



WARNING

When using the PTO drive with a stationary tractor, ALWAYS make sure that the gears are in neutral and that the parking brake is applied.



WARNING

Check to make sure that all implements operated by the PTO are fitted with the correct protections, are in a good condition and comply with the provisions established by the law.



WARNING

Before driving an implement through the PTO, ALWAYS make sure that all bystanders are well away from the tractor.

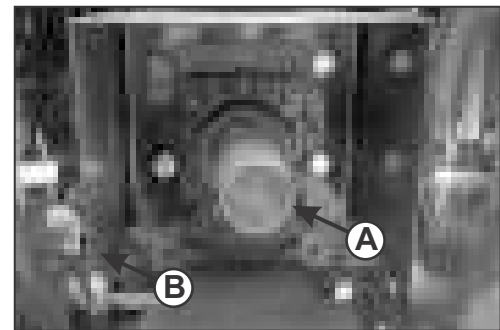

## A requirement to use only power take-off drive shafts with adequate guards



CAUTION

Remove PTO cap (A) only when the PTO is to be used. As soon as PTO-driven implement is removed, re-install cap over PTO stub shaft again afterwards. There are various versions of PTO guard that are not shown here.



CAUTION

Never operate PTO unless the master shield is in the position shown. Switch off the PTO before raising the implement.

## OPERATION



Before using the PTO, the maximum permissible angle of articulation on the telescoping driveline must be ascertained. During operation, there must be no contact between the PTO guard and the telescoping driveline. This is particularly important when turning corners.



Always put a guard (B) on the telescoping driveline and take action to prevent it from turning with the shaft. Do not operate the telescoping driveline unless a guard is installed that covers the PTO shaft completely and does not turn with the shaft.



Stay clear from the area of the three-point linkage when controlling it.



The mounted machinery must be lowered on the ground before leaving the tractor.



Stay clear from the area between tractor and trailed vehicle.

### Information about using implements with power take-off drive shafts

1. CAUTION: Shut off engine and disengage PTO before attaching PTO-driven equipment.

CAUTION: High-inertia implements do not come to a standstill the moment the PTO control lever is shifted to the disengaged position. Do NOT approach the implement while it is "coasting down". Do not work on the implement until it has stopped.

CAUTION: Before attempting to clean, adjust or lubricate a PTO-driven machine, the TPL, always make sure the PTO is switched off and stopped, the tractor engine is shut off and the ignition key is removed.

Turn key off to stop engine.

2. Attach implement to tractor before connecting PTO drive line. Lock TPL in upward position if it is not to be used.
3. Rotate PTO shield upward for clearance. With engine off, turn shaft slightly by hand if necessary to line up splines. Connect drive line to PTO shaft. Pull out on shaft to be sure drive line is locked to PTO shaft. Place PTO shield in downward position.
4. Be sure all shields are in place and in good condition. Never operate PTO unless master shield is properly installed. WITH ENGINE STOPPED, check integral shields on drive line by making sure they rotate freely on shaft. Lubricate or repair as necessary.
5. Check carefully for any interference, make sure TPL is locked in the upward position if it is not used.

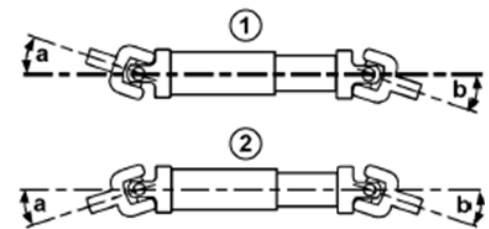

Articulation on Telescoping Driveline

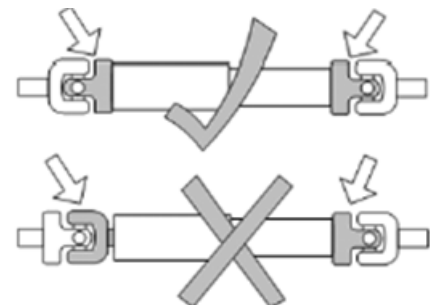

Align Forks Correctly

- 1 - Z-shaped layout
- 2 - W-shaped layout

## OPERATION

As far as possible, angles (a) and (b) at the universal joints should be the same at both ends of the Telescoping driveline.

In applications where this is not the case (e.g. sharp turns with PTO engaged), it is recommended to use a continuous-velocity drive shaft.

NOTE: The two schematic drawings do not show any guards on the telescoping driveline. A guard is mandatory when using telescoping drivelines.

IMPORTANT: Only operating conditions described in the Operator's Manuals of the various implements are permitted. This applies particularly to maximum permissible angle of articulation, to the use of freewheel clutches and overload clutches, and to the prescribed amount of overlap when shaped pipes are pushed together.

### Hydraulic Coupling Devices

Pull dust cover off coupler (A). When connecting the hose, ensure that the connectors are perfectly clean.

IMPORTANT: Connect the trailer's pipe with the QRC's , operate the DCV lever respectively to lift trailer.

### Power Steering

The tractor is equipped with power steering with a pump of 5.5cc & steering unit of 40cc which enables the operator for ease in operation.

The power steering function goes off when the engine is shut off.

IMPORTANT: Before using a PTO-driven implement, take action to ensure that the telescoping driveline is lubricated regularly. Comply with instructions in the Operator's Manual provided by the manufacturer.

IMPORTANT: On multi-component telescoping drivelines, the yokes at each end must be aligned as shown.

The yokes at each end must NOT be at 90° to one another.

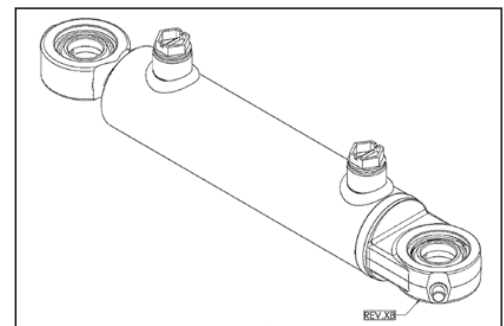

# OPERATION

## Transport Lock

It acts as safety device during transportation of implements. It is located on front side of Hydraulic Rear Cover below driver seat.

**Use:** For safety lock fully tighten the response valve by rotating it in clockwise direction.



*Response Valve should always be closed during implements transportation.*



## Hi-Low Lever

This lever is used to change the low speed into high speed or vice versa when tractor is moving. According to requirement you can use it with combination with main gear lever.

Speed Selection:

1. Neutral Position: Lever in the middle cut.
2. High Speed: Move the lever out of the cut and shift towards rear end.
3. Slow Speed: Move the lever out of cut and shift towards front end.

Select the speed before tractor movement.

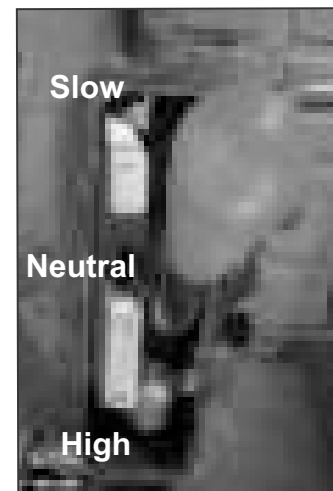

## Differential Lock Pedal

When you press the differential lock pedal, both the wheels will rotate at same speed.

**IMPORTANT:** *Differential lock operation should be in straight position only and should be disengaged at turnings to avoid any damage of differential assembly.*



*Do not apply differential lock while tractor speed is more than 6 kmph on turning.*



## DCV Lever

The tractor is equipped with single acting (1SA) directional control (DC) valve. The operation is with a lever located beneath LHS of driver seat. Quick Release Coupler (QRC) is fitted at rear side of tractor.



*Use cylinder implements only according to DCV fitted in your tractor.*

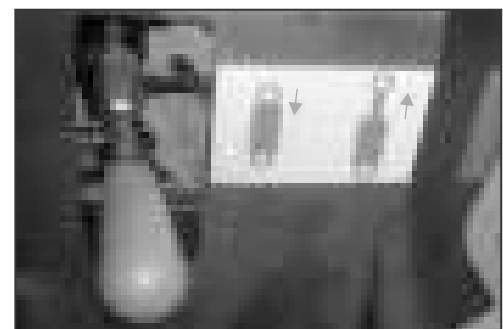

## OPERATION

### Service Brakes (A)

The main brakes are operated by means of two pedals, one for each rear wheel. Braking on one side assists steering in tight maneuvers. By locking rear wheel on the inside of curve, you can virtually turn the tractor around on its own axis. For simultaneous braking during normal use and for on road use, simply lock the two pedals together with the special brake coupling lock.



*Always keep the brake pedals coupled for on-road driving to ensure simultaneous braking on both rear wheels. Never use the brakes independently when driving on public roads.*



*If you ever notice the brakes becoming less effective, identify the cause immediately and repair. When working on slopes avoid using the brakes as much as possible and select a lower gear in order to use engine braking.*

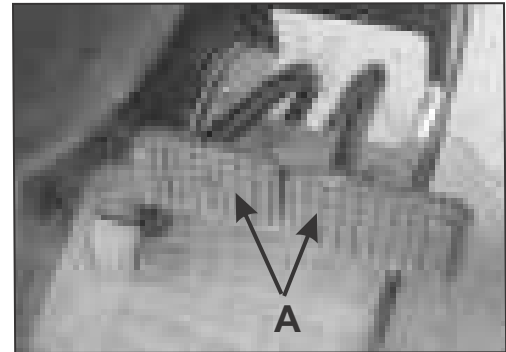

### Parking Brake (B)

The Parking brake is engaged by lever (B) which acts on the brake discs by means of a mechanical control.

#### Parking brake engagement:

- Press the brake pedals and pull down the lever completely to operate the parking Brake.

#### Parking brake release:

- Press the brake pedals and pull up the lever to disengage the parking brakes.



*Always engage the hand brake when the tractor is used for work at a standstill, even if only for brief periods of time.*

**IMPORTANT :** *Driving the tractor with the parking brake partially engaged will cause damage to internal brake components.*

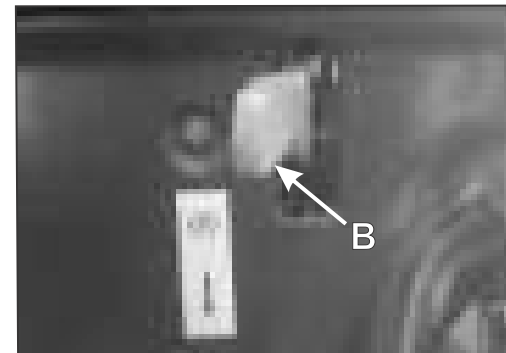

Parking Light Indicator



## OPERATION

### Ground Speed Chart

Following listed gear speeds are in kmph at rated rpm with 8.30 x 20 Rear tyres.  
To convert Kmph into mph, multiply with 0.625.

Range	Gear	Speed
 <b>SLOW</b>	<b>1st</b>	<b>1.53</b>
	<b>2nd</b>	<b>2.22</b>
	<b>3rd</b>	<b>3.87</b>
	<b>Reverse</b>	<b>1.96</b>
 <b>FAST</b>	<b>1st</b>	<b>6.73</b>
	<b>2nd</b>	<b>9.79</b>
	<b>3rd</b>	<b>17.05</b>
	<b>Reverse</b>	<b>8.60</b>

**Note:** Above speeds can vary within  $\pm 5\%$  according to tyre pressure & loading conditions.



# OPERATION

## Wheels and Tyres

Tyres Play vital role in transportation and agriculture operations. It is the most important factor in the efficient performance of tractor it should be used only as per company recommendation. Here we will discuss only pneumatic tyres.

On any tyre there is some marking which represents its size & capacity e.g. Tyre marking is 8.3x20, 4 ply rating i.e. 8.3 inch is the section width, 20 inch is the bead diameter. Ply rating doesn't show that the same No. of plies are inserted in tyre. It is only comparative measure of the load carrying capacity (L.C.C) of tyre. As more ply rating shows more L.C.C. at the same time as L.C.C. increase the shocks absorption capacity decreases.

In general, tractor is considered for two types of work:

- Work on soft soil where maximum adhesion is needed. In this case there will be use of lowest pressure compatible with the load carried.
- Work on hard ground and roads, towing etc. In this case there will be use of maximum pressure.

## In Field Operations

(Recommended Tyre Pressure : Front - 17 P.S.I & Rear 22 P.S.I)

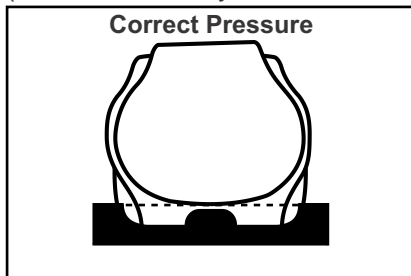

- Good adherence by dirt grousers.
- Good cleaning of the tread

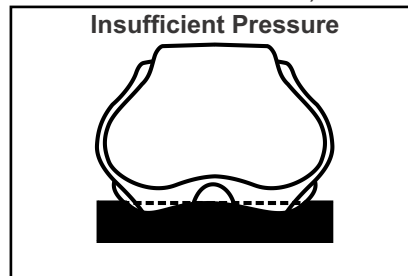

- Reduce adherence through lack of tyre grip.
- Deterioration of tyre casing by traction forces.

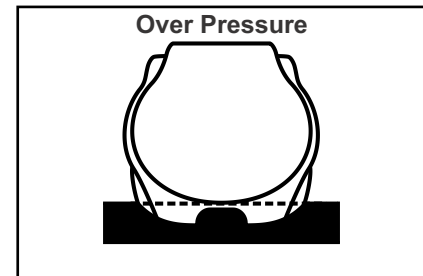

- Reduce group due to lack of cleaning
- Deterioration due to compacted ground.

## On Road Operations

(Recommended Tyre Pressure : Front - 16 P.S.I & Rear 20 P.S.I)

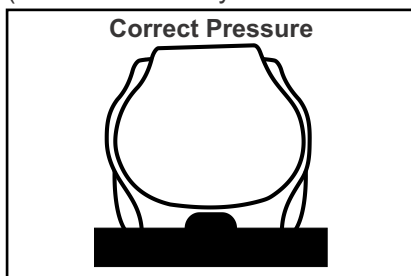

- Resistance to Wear

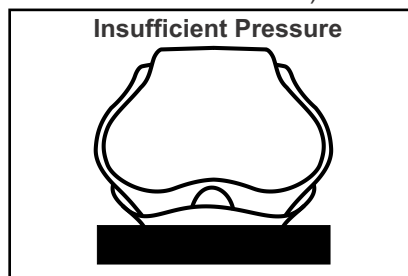

- Reduce adherence through lack of tyre grip.
- Deterioration of tyre casing by traction forces.

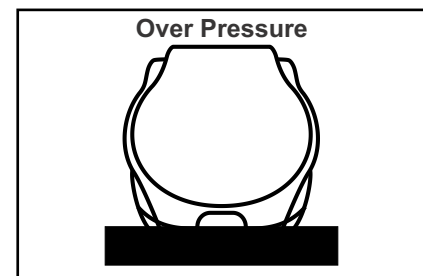

- Reduce group due to lack of cleaning
- Deterioration due to compacted ground.

Load Carrying Capacity				
Tyre Dimensions	Load carrying capacity as per tyre load index	Technical permissible mass per axle	Max. permissible vertical load on coupling fit	Recommended tyre pressure (kg/cm <sup>2</sup> )
6.00 – 12	325 kg @200kpa	650 kg	S:2.44kn	1.75
8.30 – 20	710 kg @200kpa	1420 kg	S:2.44kn	0.84

# OPERATION

## Check Wheel Nut Bolt

Check wheel nut of the front and rear wheel. Torque it as per specification.

Rear wheel : 130 Nm

Front wheel : 72 Nm

## Ballasting of Tyre

Proper ballasting is an important factor in tractor performance. For better performance of tractor, the weight of tractor can be decreased as per requirement. Maximum productivity can be achieved only if tractor weight is appropriate for the job. Ballast is required for traction and stability. The tractor is equipped with detachable front toe hook. Following factors determine amount of ballast.

- Soil surface loose or firm
- Type of implement
- Travel speed and tractor power output partial or full load.

By default tractor is equipped with 2 Front Weights of 15Kg each.

Use the front toe hook to tow the tractor.

## Hydraulic

### Hydraulic System

In this tractor live hydraulic system is provided in which hydraulic pump is driven by engine and mounted at cover of engine. As the engine run, the hydraulic pump also starts working and the oil is transferred from pump to lift via priority valve (located at LH side of Engine). Transmission lubrication oil is used as hydraulic oil.

### Position Control Lever (A)

This orange colour lever is mounted on R.H.S. of driver seat which enables raising or lowering the implement/lift.

### Priority Valve

Priority valve gets oil input from hydraulic system and serves as a unit to provide oil to:

1. Steering Mechanism
2. Hydraulic Lift
3. DCV unit

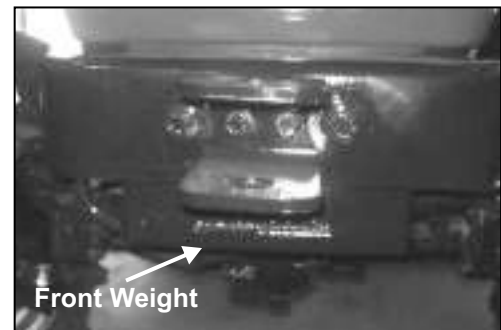

## OPERATION

### Three Point Linkage

Three-point linkage is used to mount the implement, which is fully mounted, or semi-mounted and used for different field operation. Three-point linkage is controlled by hydraulic lever. In this two lower link are available, of which one side of the lower link is attached with differential housing and other is used to hitch the lower pin of the implement. Lift rods are mounted on lift arm that is operated through rockshaft. Loose side of Top link is used for attaching upper hitch pin of implement. Top link is adjustable for proper setting of implement and ease at the timing of joining.

#### Adjustable Lift Rods (A & B)

The lift rods can be adjusted mechanically or hydraulically, depending on the lifting, to make the lower links level and lined up with each other. This will depend on the type of implement being used and the work to be done.

#### Top Link (C)

For length adjustment of top link, fix the top link other end and turn the lever for increasing or decreasing the length. During field operation lock the tube to avoid unnecessary turning.

#### Lower Links (D)

Lower Links are provided for hitching the implement.

#### Attaching Implement to 3 Point Linkage

Position the tractor to align corresponding linkage with the hitch points of implements. Keep the implement on hard & leveled surface and attach as per given below instructions :

- First attach with Left lower link (E) and Right Lower Link (F)
- Then at last attach with Top Link (C)

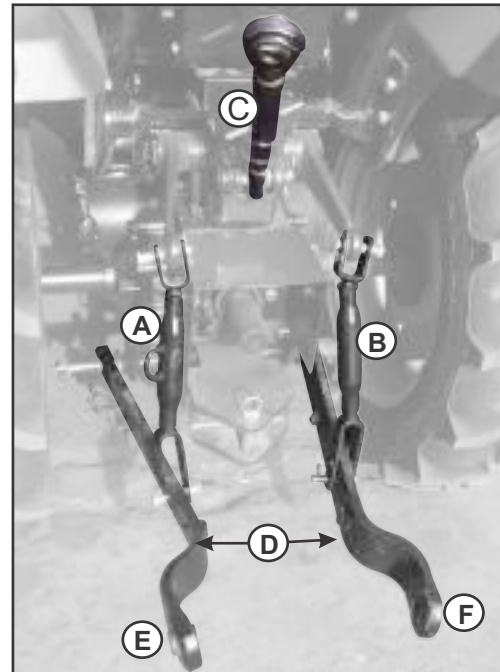

*Stay clear from the area of three point linkages while attachment and detachment of implements.*

**NOTE:** Maximum allowed vertical load on rear hitch is 2.44 kN.



## **CHAPTER - 5**

# **MAINTENANCE**



# MAINTENANCE

## Maintenance Schedule

Observe the following maintenance schedule. This maintenance schedule is applied to tractors which are operated under normal conditions. When your tractor is frequently operated in muddy places, greasing must be carried out more frequently and when the tractor is often operated in dusty places, clean the air cleaner element and fuel filter more frequently. Extra servicing must be carried out according to particular situation.

Parameters	50 hrs/ 1st Service	250 hrs/ 2nd Service	500 hrs/ 3rd Service	750 hrs/ 4th Service	1000 hrs/ 5th Service	1250 hrs/ 6th Service	1500 hrs/ 7th Service
<b>General</b>							
Washing	W	W	W	W	W	W	W
Greasing	G	G	G	G	G	G	G
Re-tighten All Fasteners	CT	CT	CT	CT	CT	CT	CT
RVM Holder	CT	CT	CT	CT	CT	CT	CT
<b>Engine</b>							
Engine Oil	R	R	R	R	R	R	R
Engine Oil Filter	R	R	R	R	R	R	R
Tappet Clearance	CA	CA	CA	CA	CA	CA	CA
Fuel Filter Element	R	R	R	R	R	R	R
Fan Belt Tension	CT	CT	CT	CT	CT	CT	CT
Radiator Coolant Level	C	C	C	C	C	C	C
Air Cleaner Element	CL	CL	CL	R	CL	CL	R
<b>Clutch</b>							
Clutch Pedal Free Play	CA	CA	CA	CA	CA	CA	CA
<b>Transmission / Hydraulic</b>							
Transmission Oil	C	C	C	C	R	C	C
Transmission Breather Assy	CL	CL	CL	CL	CL	CL	CL
Operation of Hydraulic Lift	C	C	C	C	C	C	C
Suction Starainer	CL	CL	CL	RR	CL	CL	RR



*Safety Starter Switch is to be replaced after every 2000 hours or 4 years, whichever is earlier.*

# MAINTENANCE

Parameters	50 hrs/ 1st Service	250 hrs/ 2nd Service	500 hrs/ 3rd Service	750 hrs/ 4th Service	1000 hrs/ 5th Service	1250 hrs/ 6th Service	1500 hrs/ 7th Service
<b>Brakes</b>							
Operation of Brakes	C	C	C	C	C	C	C
Brake Pedal Free Play	CA	CA	CA	CA	CA	CA	CA
<b>Steering</b>							
Steering Operation	C	C	C	C	C	C	C
<b>Front Axle 4x4</b>							
Front Axle Differential Oil	C	C	C	C	R	C	C
Breather Assy	CL	CL	CL	CL	CL	CL	CL
Front Axle Pivot	C	C	CA	C	C	C	C
<b>Wheels and Tyres</b>							
Front Wheel Bolts	CT	CT	CT	CT	CT	CT	CT
Rear Wheel Bolts	CT	CT	CT	CT	CT	CT	CT
Tyre Air Pressure	CA	CA	CA	CA	CA	CA	CA
<b>Battery</b>							
Battery Electrolyte Level	C	C	C	C	C	C	C
Battery Terminals	CL	CL	CL	CL	CL	CL	CL
<b>Electrical</b>							
Functioning of All Gauges & Meters	C	C	C	C	C	C	C
Functioning of Alternator & Starter	C	C	C	C	C	C	C

R-Replace, RR-Replace if Required, CT-Check & Tighten, C-Check, CR-Clean & Replace, CA-Check & Adjust, CL-Clean  
Beyond 1500 Hrs Repeat the cycle every 250 hrs.

- Engine Oil Grade should be selected as per operating Temperature condition.
- Anti freeze should be used in sub zero ambient temperature.
- Clean Air Cleaner element as and when required as per field operating conditions.
- Clutch pedal play should be adjusted as per field operating conditions.



# MAINTENANCE

## Fuel Tank Filling



*Comply with the following instructions when working with the diesel fuel:*

1. Do not smoke while filling the fuel tank because diesel is flammable liquid and catch fire easily.
2. Mixtures of diesel fuel and alcohol are not approved since the resulting lubrication of the fuel injection system is insufficient.
3. Clean the area around the filler neck where the fuel is poured.
4. Fill the tank at the end of the day to prevent the formation of overnight condensation.
5. Never remove the plug or fuel the tractor while the engine is running. Keep control of the pump nozzle whilst the tank is being filled.
6. The tank must not be completely filled. Allow space for an increase in volume. If the original tank plug is lost, it must be replaced with an original spare which must be fully tightened.
7. Dry up any fuel spill immediately.

## Fuel Requisites

It is important to use good quality fuel for the long life & good performance of the engine. The fuels must be clean, well refined and non-corrosive for the fuel system components. Make sure that you use fuel of a known quality and reliable origin.

## Fueling

Before you fuel the tractor, clean the zone around the filler neck to prevent foreign bodies from entering the tank. After fuelling, tighten the plug properly.

## Fuel Storage

Take all the necessary precautions to ensure that stored fuel does not become polluted with dirt, water or other substances.

Store fuel in black iron cans. Do not store it in galvanized cans as the galvanization treatment would react with the fuel and form compounds that would spoil the injection pump and injectors.

- Store fuel cans away from direct sunlight and slightly tilted, so that any sediment inside is eliminated through the outlet tube.
- To make sludge and water condensation easier to remove; there should be a discharge plug (c), in the lowest point, on the opposite side to the drain tube.
- If the fuel is not filtered from the storage can, use a funnel with the fine gauge mesh over the fuel tank fill plug inlet when fueling.
- Plan your fuel purchases so that summer fuels are not kept for too long and used in the winter.

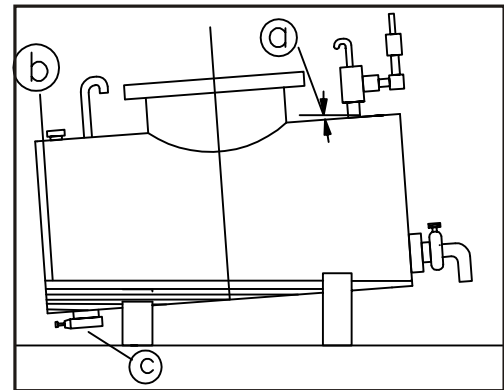

Setting up a tank for fuel storage and decanting.

- a. Slope 25%.
- b. Condensation water.
- c. Sludge drain plug.



Diesel Tank Cap for Filling Diesel

# MAINTENANCE

## Checking Engine Oil Level

Before checking the oil level be ensure that tractor is parked on leveled ground. Stop the engine and wait for some time, as all oil should return to oil sump.

Check the oil level by unscrewing dipstick (located at RHS of the Engine). Top up the oil level if the level is below the minimum level mark. Do not over fill than maximum level mark. Oil level should be between maximum and minimum marks.

We recommend SAE15W40 grade of Engine Oil.

Recommended oil viscosity according to air temperature	
Temp. (°C)	-30 -20 -10 0 10 20 30 40 50
Engine Oil Viscosity	SAE10W
	SAE30
	SAE40W
	SAE15W-40

## Replacement of Oil Filter & Engine Oil

### Changing Oil Filter:

1. Stop your tractor to the side of road on leveled surface and drain the engine oil in an oil pan after removing the drain plug.
2. Remove the oil filter by rotating it in anti-clockwise direction by hand or with the filter wrench.
3. Take new oil filter and check it for proper seating of gasket.
4. Apply clean engine oil to gasket on the new oil filter.
5. Install oil filter. When the filter gasket contacts the mounting surface of filter, tighten the new oil filter.

### Refilling Engine Oil :

1. Re-install the Drain plug and remove the oil filler cap.
2. Fill the engine oil with the specified engine oil (SAE15W40) to the specified level to sump capacity (4.2 Ltr.) from oil filler cap.
3. Insert into the oil level gauge guide, then pull out the gauge again.
4. Ensure that oil level should be between the MAX. & MIN. marks on the oil level gauge. If less, then pour the oil to bring it to specified level.
5. Install the oil filler cap after a refill.
6. Check the oil pan and other parts for oil leakage.
7. Start the engine, allow it to run idle and don't race it immediately.

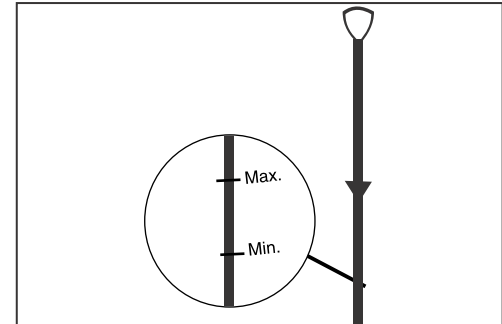

Dipstick marks

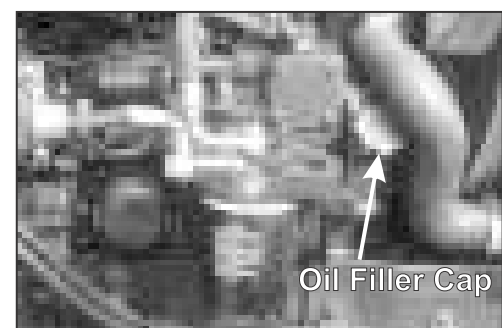
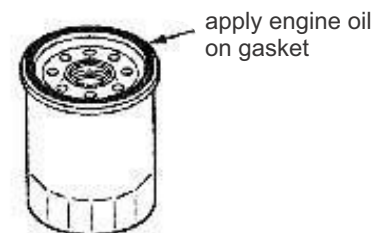
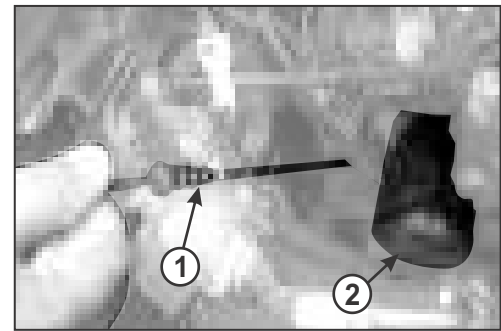

# MAINTENANCE

## Replacement of Fuel Filter

1. Shut down fuel cock.
2. Remove the filter by rotating it in anti-clockwise direction by hand or special wrench.
3. Take new filter and check it for proper seating of gasket.
4. Apply clean engine oil to gasket on the new fuel filter.
5. Install fuel filter, when the filter gasket contacts the mounting surface of filter, tighten the filter and ensure that there is no leakage.



## Fuel Filter Replacement / Air Bleeding of Fuel System

After changing the fuel filter the system must be air - bleed in following manner:

1. Switch ON the ignition key to start the electric pump till completion of air bleeding process.
2. Loosen the vent plug (A) at the top of fuel filter body.
3. Tighten the vent plug (A) until the bubble free fuel flows from the air vent plug hole.
4. Loosen the return valve (B) of FIP and allow the air to flow out from the system.
5. Tighten the vent plug (B) until the bubble free fuel flows from the return valve.
6. Loosen the injector pipes (C) and crank the engine till the bubble free fuel flow is ensured.
7. Tighten all the injectors.

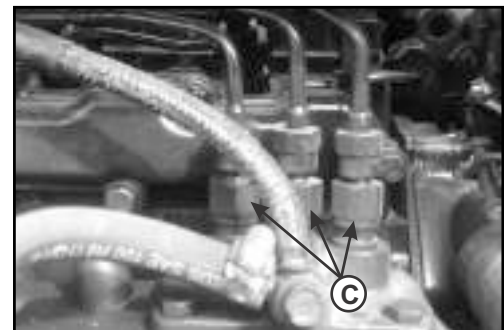
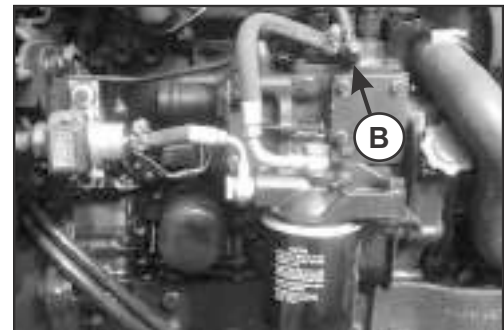

## Radiator

### Coolant Level in Radiator (Hot)

Slowly open the radiator cap (1) up to the safety catch (about 1/3 turn). Wait to allow the steam to escape. Continue opening the cap, press it down firmly to release the safety catch. The level of coolant should just touch the tab located in the filling spout.

If the level has dropped, check the entire cooling system for leakage (radiator, hoses etc.) If there is no leakage, Top up the coolant.

Fill the reserve tank (2) with coolant up to the FULL line mark for coolant Top up.

Coolant is mixture of water and anti scaling / anti rusting agent in recommended ratio.

**In Sub Zero Temperature climate conditions use Ethylene Glycol Antifreeze Agent along with water in following ratio:**

Temperature Range °C	0 to -3	-3 to -8	-8 to -16	-16 to -25	-25 to -37	-37 to -55
Antifreeze (%)	10	20	30	40	50	60

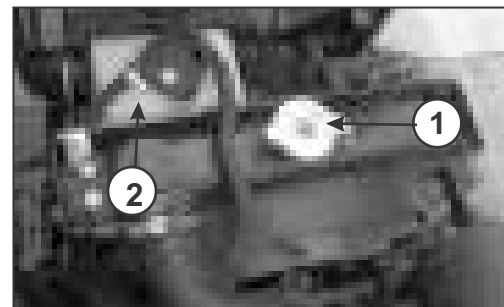

# MAINTENANCE

## Radiator Draining & Flushing (when Cold)

1. Remove the radiator cap and drain plug (A).
2. Let the coolant drain out. Close drain cock and plugs. Flush the cooling system with water / Cleaning Solution for 15 minutes, then drain the cleaning solution.
3. Refit the drain plug and refill the coolant (Mixture of water, anti scaling agent, antifreeze).
4. Run the engine with radiator cap open and accelerate 2-3 times and Top up coolant if required.
5. Refit the radiator cap and ensure tightness all the connections for any leakage.

## Radiator Fins Cleaning

1. Check Radiator Fins for holes or cracks for chocking.
2. To clean the radiator blow compressed air from engine side to outside.

**Capacity of Radiator : 2.5 Ltrs**

## Radiator Cap

Cooling system is closed pressurized system so don't operate the tractor without radiator cap or cap with damaged rubber seals/defective release valve to avoid water loss and engine overheating.

Use genuine radiator cap only.

## Inspection of Hoses

### Check/replace hoses

Check hoses regularly – on every service/before cranking tractor after long idle standing– for leaks, kinks, cuts, tears, rubbing, bulges, corrosion, exposed fabric and other signs of wear and damage.

Replace worn or damaged hoses immediately.

Replacement hoses are available from your dealer.

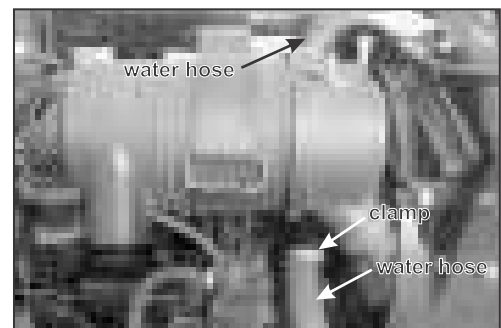
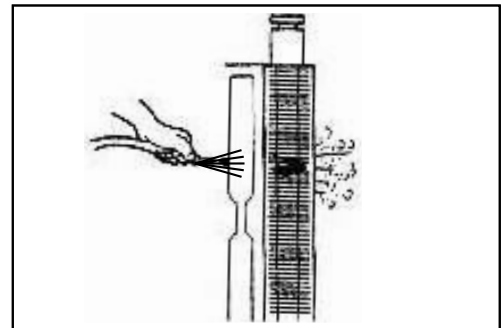
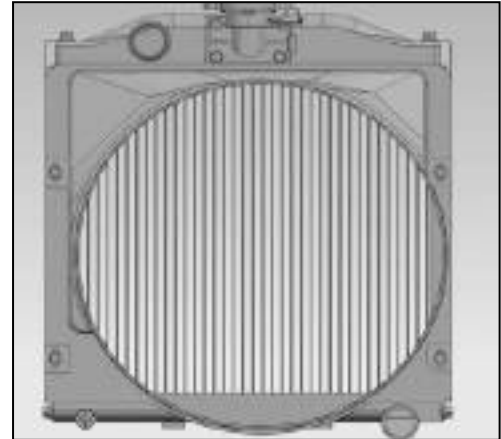

# MAINTENANCE

## Air Cleaner (Dry Type)

### Air filter discharge valve

Discharge the dust deposits and sediments daily by pressing the rubber valve (4) on the air filter housing (1).

### External Cartridge Of Dry Air Filter

- (1) Air Filter Housing
- (2) Clamp
- (3) Cover
- (4) Rubber Valve
- (5) Air Cleaner Element

### Important Instructions :

- ! Clean the air cleaner element at first 50 hrs & then after every 250 hrs of operation or whenever choke indicator glows on dashboard.
- ! Clean filter element by blowing air (max. pressure not more than 5.9 bar) from inside.
- ! Use clean cloth to wipe sealing areas of element.
- ! After replacing new filter element ensure matching of (◀) mark on cover with the mark (▶) on air filter housing.
- ! Ensure proper seating of filter into housing before latching the cover. Do not use latches on the cover to force the filter into air cleaner that could cause damage to housing and will void the warranty.
- ! Ensure proper seating of all rubber rings. Replace the damaged ones.

**Replace air cleaner element after three cleaning operations or at every 750 hours, whichever is earlier.**

**IMPORTANT:** NEVER attempt to clean the filter element with exhaust gas from the engine. NEVER ever use oil on dry filter. NEVER ever use oil, diesel fuel, paraffin or solvents to clean the filter element.

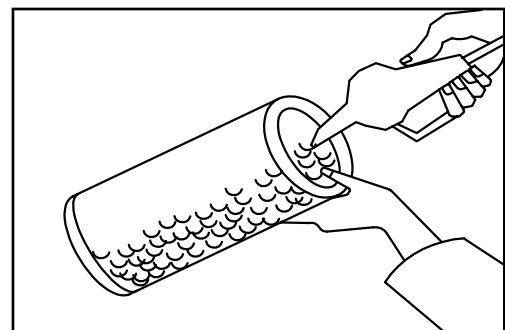
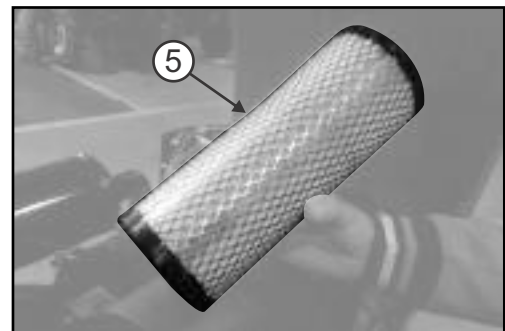
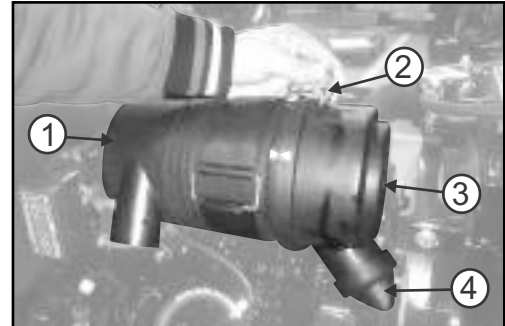

# MAINTENANCE

## Clutch Pedal

By pressing clutch pedal the motion and power or engine will be disengage from gearbox. Release the clutch pedal slowly for transfer the engine power to gear box.

### Method to Check Clutch Pedal Free Play

Press down the clutch pedal and measure the free play of pedal as shown in the figure. The distance should be 25 to 30 mm. If the distance is less than 25 mm or higher than 30 mm then get it adjusted.

**IMPORTANT:** Do not keep foot on clutch pedal while tractor is in running condition. It may cause excessive wear of clutch and clutch falls before its life time.

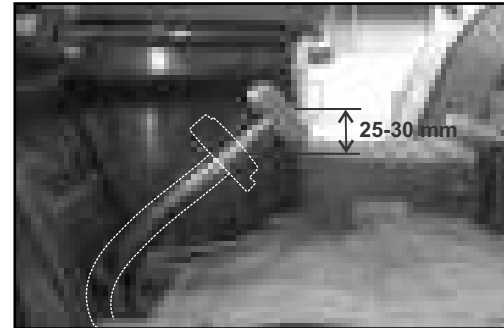

## Foot Brake Pedals

Use independent brake in the field operations. In field you will turn more sharply by pressing brake pedal for the side wheel on the turn. The pedals must be locked for road use.

### Method To Check Brakes

Release the hand brake. Uncouple the two pedals. Press down the right hand pedal and measure the free play of pedal as shown in the figure. The distance should be between 35-40 mm. If the free play is less than 35 mm or higher than 40 mm then adjust the both hex nut on actuator tie rod until free play comes to 35 to 40 mm. Now, press down the left hand pedal. If the values are not equal with the right hand pedal then repeat the same procedure until values come equal.

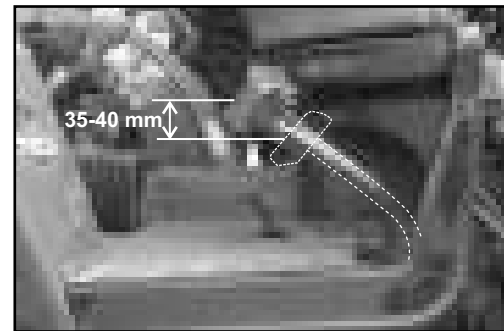

*Difference in the free play will lead to unbalanced brakes, the tractor can slew in the event of violent braking. The wheel on which the brakes are applied locks and the tyre wears out quickly. During Road Operations both the brake Pedals should be locked.*

## Steering Cylinder Knuckle Joints

Have the knuckle joint nuts (1) checked by an authorized service center after the first 50 hours and then at every service.

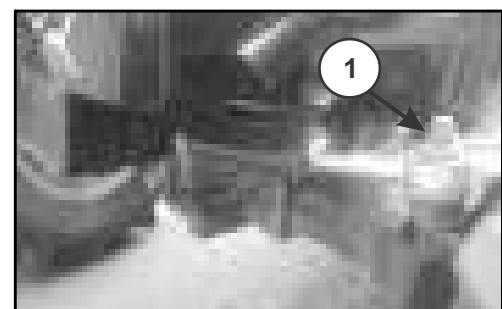

# MAINTENANCE

## Oil Changes in 4WD Front Axle

Oil filling plug (A) is provided on right hand side of the front axle (as shown in fig.). Open the plug and check the oil level. The lower point of the plug should be immersed in the oil.

Front Axle Oil Capacity: 2.7 Litres  
Oil Grade: EP-80

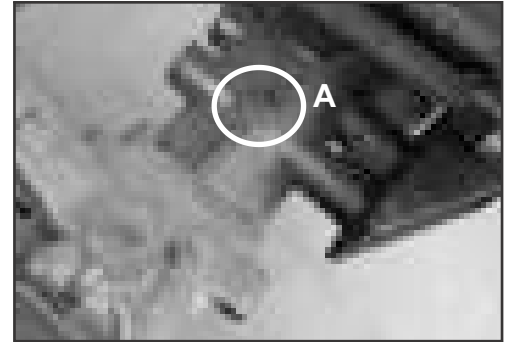

## Oil Changes for Transmission, Rear Final Drives and Power Lift Hydraulic Circuits

**NOTE:** When draining out and filling oil and checking oil level, take care that the transmission is in horizontal position.

### Oil draining

1. Lower the lift arms to the ground.
2. Remove the plugs located at LH side of lower portion of brake housing to make oil draining easier.
3. Place vessel under all drain plugs of transmission housing to collect the oil as it drains out.



*Beware of powerful oil jets. Follow all safety rules.*

4. Remove the plugs and drain out the oil.
5. Clean the plugs and fit back on.

### Filling up the transmission

1. Fill up the transmission oil from dipstick plug (1) opening to the maximum level mark on the dipstick.
2. Put the gearshift lever in neutral and start the Engine. Let it run on idle until the oil reaches a temperature over 25°C.
3. Check that the transmission oil reaches the required level mark on the dipstick.
4. If required, fill up to the correct level.

**NOTE :** Let the oil stabilize before checking its level.

**IMPORTANT:** See the Lubricants and Fuel chart for the type of oil to be used according to the transmission type.

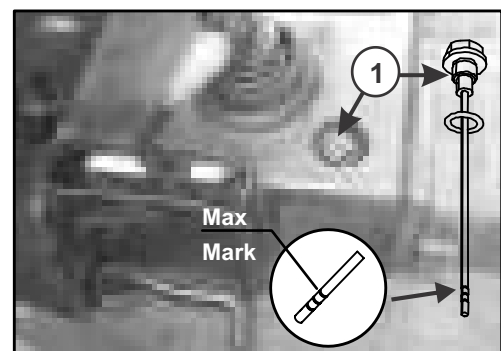

**NOTE :** If implement used require more quantity of oil, make sure that the transmission contains enough oil for every work condition. Top up as required.

# MAINTENANCE

## Recommended Oil grades & application range

We recommend use of ELF-2412, SAE-80W oil grade for transmission and oil brakes.

Refer the chart for appropriate oil viscosity according to the ambient temperature.

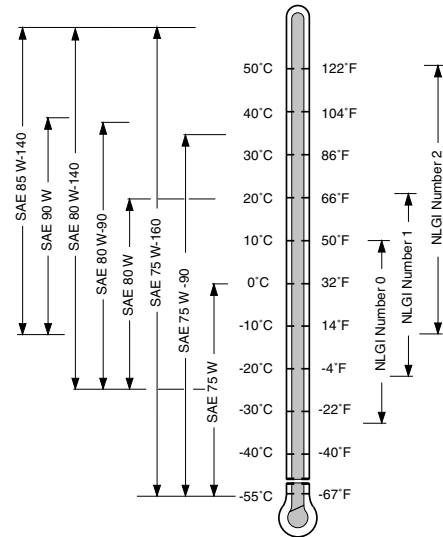

Recommended oil viscosity according to air temperature

## Cleaning of Suction Strainer (A)

At each oil change, thoroughly clean suction strainer by washing with light oil or kerosene.

Failure to observe this will result in extensive shortening life of hydraulic system.

### Cleaning Procedure of Suction Strainer:

- (1) Remove all hose warm clips (1).
- (2) Separate the Hose pipes (2) from Strainer Assy.
- (3) Hold the strainer assembly in left hand & remove the wire clip (5) & magnetic strainer (4) from the housing (3) with the help of right hand fingers.
- (4) Unscrew the nut (6) & remove supporting cup (7). After dis-assembling supporting cup remove the sheath (8) having ferrous dust by sliding it with the help of plastic support (10).
- (5) Clean the sheath from ferrous dust with the help of soft cloth and refit the same.
- (6) Assemble the supporting cup & tighten the nut.
- (7) Assemble magnetic strainer in strainer housing and lock it with the wire clip.
- (8) Fix the hose pipes and tighten the hose warm clips.

**Replacement:** If required, replace the magnetic stainer at every 750 Hours.

**IMPORTANT:** Do not dismantle the magnets (9) as these are assembled in polarity sequence and it should not be disturbed.

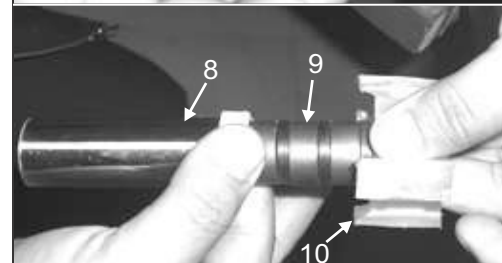
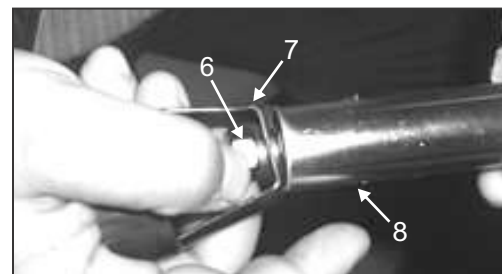
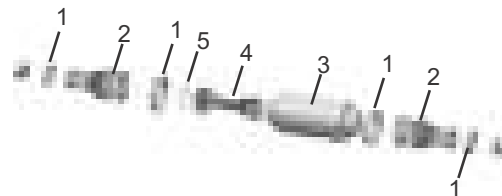



# MAINTENANCE

## General Maintenance of Electrical System

- Never Patch up the electrical circuits.
- Never replace a blown fuse by a higher capacity fuse. It could cause a fire.
- Never work on components such as the alternator or starter motor when the engine is running.
- Lastly when you are cleaning the tractor and using the pressure spray, take care not to damage the connections on the various electrical cable.

## Battery and its Maintenance

Specifications: 12V, 50 Ah

### Battery Removal Procedure

Battery is located at front of the tractor as shown in the figure, follow the below procedure to access the battery:

1. Open the bonnet.
2. Remove the fly nut (1) by rotating it anticlockwise.
3. Detach the (-)ve and (+)ve terminals (2) respectively.

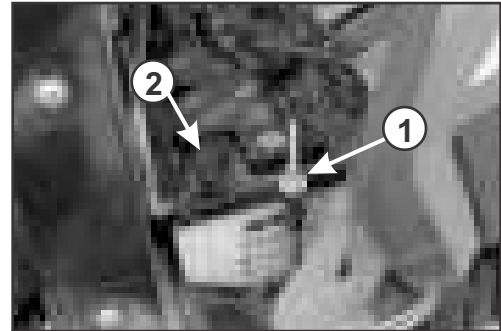

### Check Electrolyte Level

It must be as per the recommendation of battery manufacturer. If required top up with distilled water. Never add acid.

### Check Carefully Battery Charging

Protect against freezing. Insure that terminals are clean and tight. Check specific gravity of battery using a battery hydrometer.

Specific gravity of a fully charged battery is  $1.265 \pm 0.005$  at  $27^\circ\text{C}$ .

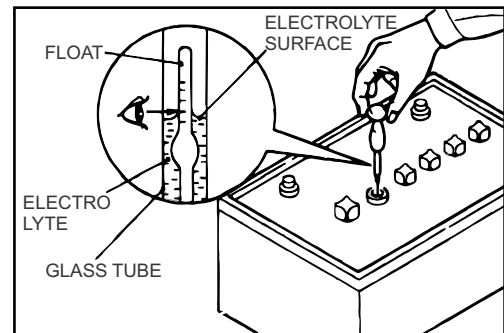

### Hazards Related to Battery

- Never Patch up the electrical circuits.
- Never replace a blown fuse by a higher capacity fuse. It could cause a fire.
- Never work on components such as the alternator or starter motor when the engine is running.
- Lastly when you are cleaning the tractor and using the pressure spray, take care not to damage the connections on the various electrical cable.
- Battery gas can explode. Keep sparks and flames away from batteries. Use a flashlight to check battery electrolyte level.



## MAINTENANCE

Never check battery charge by placing a metal object across the posts. Use a voltmeter or hydrometer.

Always remove grounded (-) battery clamp first and replace clamp last.

Sulfuric acid in battery electrolyte is poisonous and strong enough to burn skin, eat holes in clothing, and cause blindness if splashed into eyes.

### Avoid hazards by:

- Filling batteries in a well ventilated area.
- Wearing eye protection and rubber gloves.
- Avoiding use of air pressure to clean batteries.
- Avoiding breathing fumes when electrolyte is added.
- Avoiding spilling or dropping electrolyte.
- Using correct battery booster or charger procedure.

### If acid is spilled on skin or in eyes:

- Flush with water.
- Apply baking soda or lime to help neutralize the acid.
- Flush eyes with water for 15-30 minutes. Get medical attention immediately.

### If acid is swallowed:

1. Do not induce vomiting.
2. Drink large amounts of water or milk, but do not exceed 2 L (2 qt.).
3. Get medical attention immediately.



*Battery posts, terminals, and related accessories contain lead and lead compounds, chemicals known to the State of California to cause cancer and reproductive harm. Wash hands after handling.*

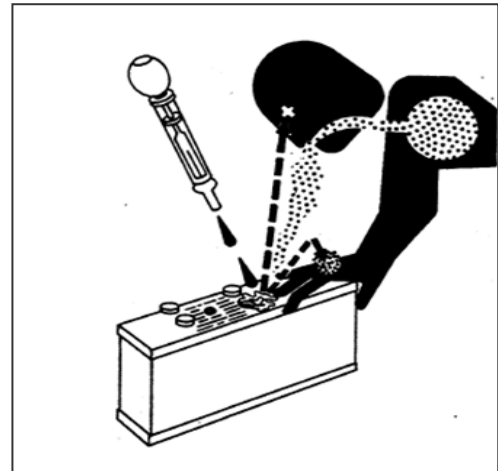

# MAINTENANCE

## Starter Motor (12V, 1.6 kW)

Starter motor is mounted on the left side of the engine. The starting motor rotates the engine crankshaft for starting.

Visually check the starter for damage. If starter is dusty, blow off dust using compressed air.

Note: If defects are found in the starter, contact your dealer.

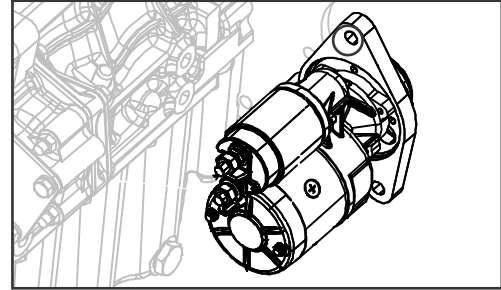

## Alternator (12V, 40A)

Alternator is fitted on Left side of engine and generates current which charges battery for healthy electrical back up.

Visually check the alternator for damage. If the alternator is dusty, blow off dust using compressed air.

Remove V-belt, and turn the pulley with hands to make sure it rotates smoothly.

Note: If defects are found in the alternator, contact your dealer.

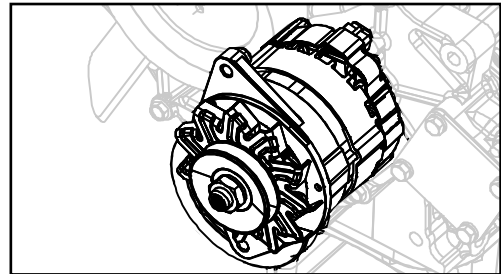

## Checking V-belt:

1. Ensure that V-Belt is free from defects such as wear, cuts or surface separations, otherwise replace with genuine specified belt.
2. Inspect belt tension by pushing the belt downward with approx. 98N (10kgf) (22lbf) force midway between pulleys. If the deflection is 10 to 12mm, the tension is correct. If the tension out of the specified value, adjust belt tension.

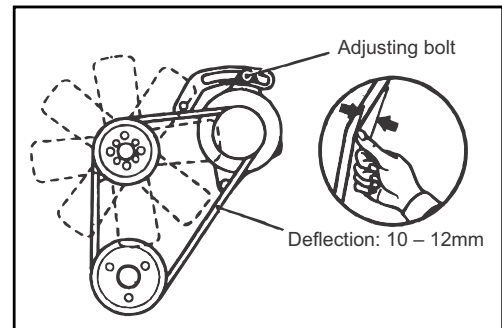

## Adjusting V-belt tension:

1. Loose all retaining bolts of the alternator and adjusting plate.
2. Insert a bar between the alternator and cylinder block and use leverage to move that alternator to have proper v-belt tension.
3. While V-belt tension is appropriate, retighten all the retaining bolts of the alternator and adjusting plate.

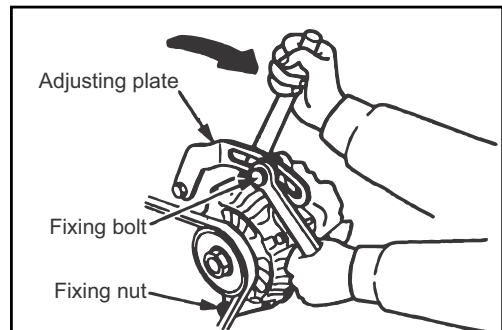

# MAINTENANCE

## Fuses in Fuse Box

Fuses against short circuits and excessive power draw protect the tractor's electrical system. The number of the fuses in the electrical system depends on the tractor model.

**NOTE :** *Before replacing a blown fuse with a new, equivalent ohm, the cause that lead to the fault should be ascertained and removed.*

## Long Idle Period

Take the following precautionary measures when your tractor is not going to be used for a long period of time.

- Park the tractor in dry sheltered place.
- Drain the coolant from the radiator and engine.
- Grease all points provided with grease nipples.
- Remove the injectors and squirt a small quantity of engine oil into the cylinders. Turn the engine over by hand, and then fit the injectors back in place.
- Generally clean the tractor ,particularly the bodywork components. Protect the painted parts by applying silicon wax and the unpainted metal parts by applying protective lubricant. Park the tractor in a dry, sheltered and possibly ventilated place.
- Make sure that all the controls are in neutral (including he electric switches and parking brake controls).
- Remove the ignition key from ignition switch.
- Make sure that the cylinder stems (of the power steering, power lift system, etc) are positioned.
- Empty the fuel tank and fill with it with new diesel fuel until the maximum level is reached.
- Remove the battery, clean the cover and spread Vaseline on the terminal and terminal caps. Now connect the battery in the ventilated place where the temperature is not liable to drop below 10 and where it is not exposed to direct sunlight.
- Check the battery charge with a voltmeter as described in the battery part of this section Recharge if it is necessary.
- Place stands or other supports under the axles in order to take the weight off the wheels. When the tractor is raised in this way, it is advisable to deflate the tyres. If this is not possible, the tire pressure must be periodically checked.
- Cover the tractor with a tarpaulin (not plastic or waterproof).

Front Work Lamp - 15 Amp	High Beam - 15 Amp
Rear Work Lamp - 15 Amp	Low Beam - 15 Amp
Plough Lamp - 30 Amp	Parking Light - 10 Amp
Brakes - 10 Amp	Horn - 10 Amp
Flasher - 15 Amp	Glow Plug - 40 Amp
Revolving Light - 10 Amp	Mobile Socket - 10 Amp
Wiper - 10 Amp	Controller Timer- 20 Amp



*At the end of the idle period. When you start the engine again, pay particular attention to the instruction about starting engine in the operation chapter.*

# MAINTENANCE

## Greasing Points

- |   |            |
|---|------------|
| 1. Clutch Actuator Shaft (LH and RH)                                      | - 2 Points |
| 2. Brake pedal shaft (LH and RH)  | - 2 Points |
| 3. 4WD Mechanism  | - 1 Point  |
| 4. Propeller shaft UG joints (Front and Rear)                             | - 2 Points |
| 5. Power Steering Cylinder Knuckle Joint<br>(On steering arm double side) | - 1 Point  |
| 6. Lift Rods (LH and RH)  | - 2 Points |
| 7. Front Axle Pivot Pin   | - 1 Point  |
| 8. Power Steering Cylinder  | - 1 Point  |



1. C.A. Shaft

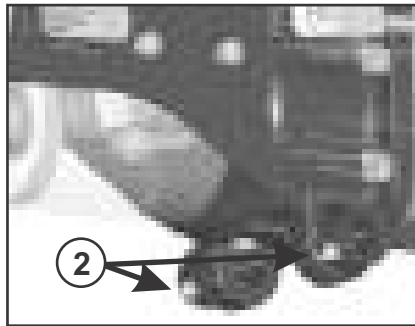

2. Brake pedal shaft

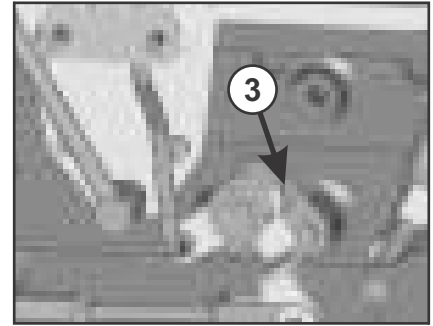

3. 4WD Mechanism

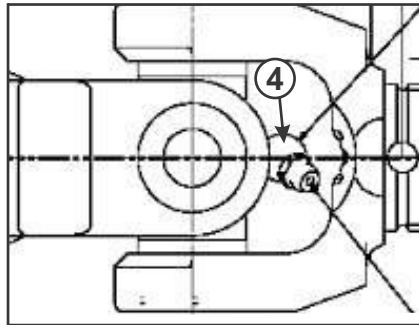

4. Propeller Shaft UG Joint

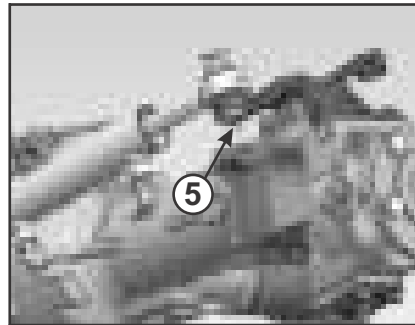

5. Power Steering Cylinder  
(On steering arm double side)

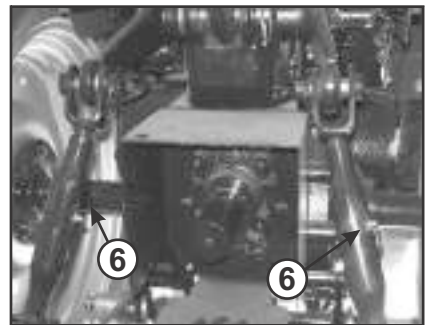

6. Lift Rods



7. Front Axle Pivot Pin

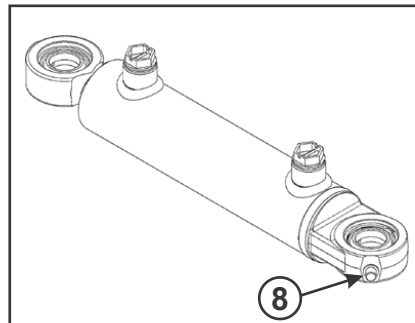

8. Power Steering Cylinder  
(On mounting bracket)

# MAINTENANCE

## Jack Up the Tractor - Lifting Points

The illustrations show the recommended lifting points for jacking up the tractor. Use a stable lifting jack with sufficient lifting force.

- A- Raise Right End of Axle, e.g. to Remove Right Front Wheel.
- B- Raise Center of Axle (Use Wooden Wedges to Prevent Axle from Tilting).
- C- Raise Left End of Axle, e.g. to Remove Left Front Wheel.
- D - Raise Rear of Tractor, e.g. to Remove Rear Wheel



- Use approved lifting equipment only.
- Jack up tractor on firm, level ground only.
- Before doing any further work on the tractor, first secure it using suitable support stands.

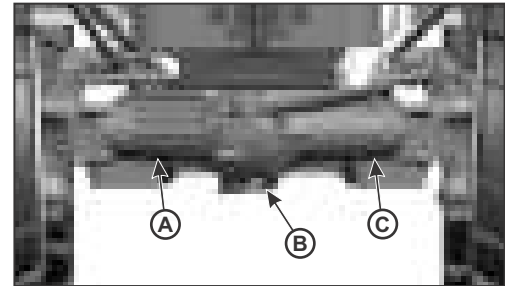

*Raise front of tractor*



*Raise rear of tractor*

## MAINTENANCE

### Oil and Lubrication Chart

Aggregate	Capacity	Recommended Grade
Engine Oil	4.2 Litres	SAE-15W40
Gearbox and Rear Axle	18 Litres	ELF-2412 (SAE-80W)
Front Axle	2.7 Litres	EP-80
Fuel	29 ± 3 Litres	High Speed Diesel conforming to IS: 1460-2000 Density 0.840 g/cm <sup>2</sup>





# MAINTENANCE

ELECTRICAL WIRING CIRCUIT DIAGRAM

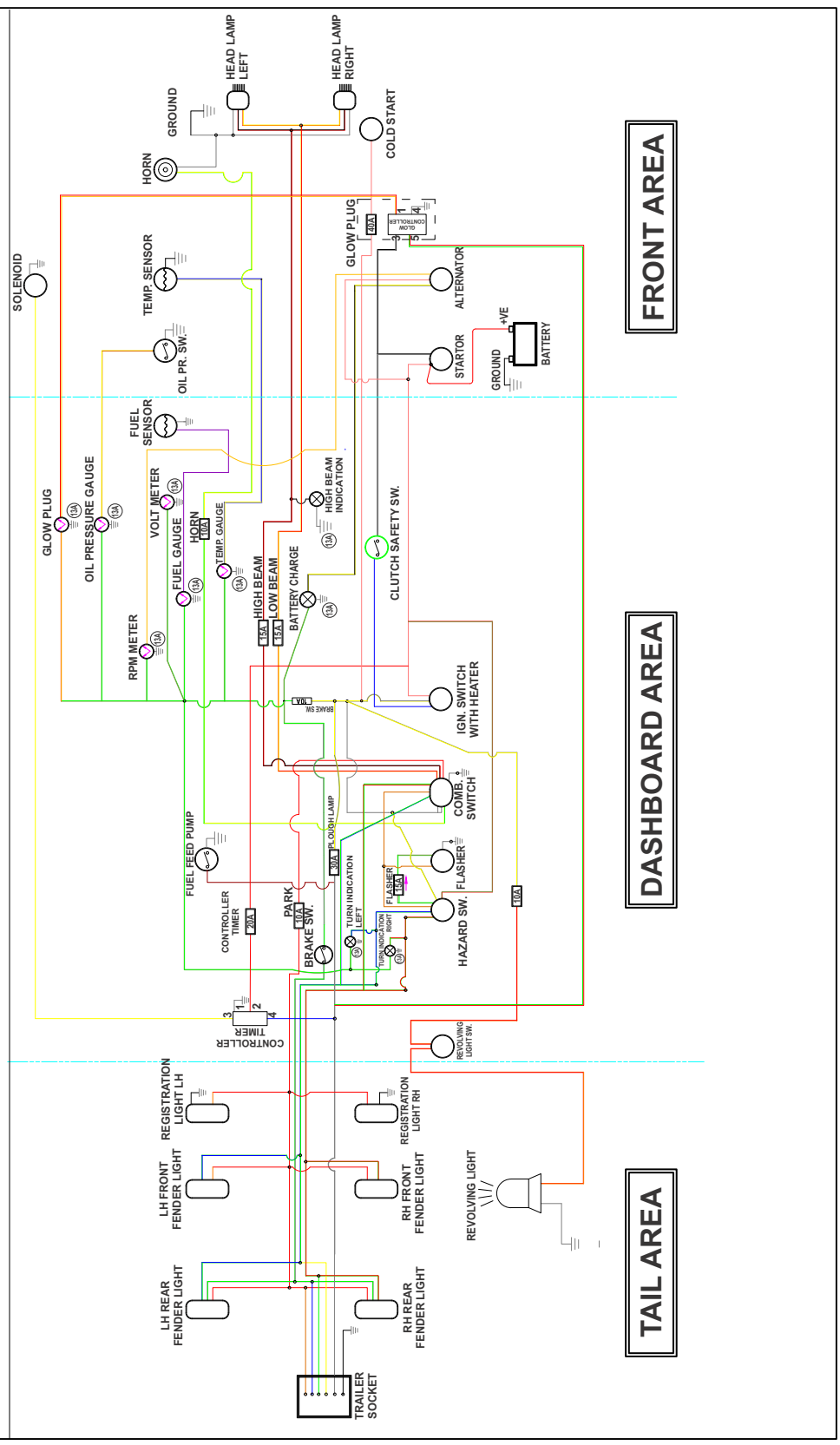



## **CHAPTER - 6**

# **TECHNICAL SPECIFICATIONS**



## TECHNICAL SPECIFICATIONS





### Technical Specifications

<b>ENGINE</b>	<b>Model</b>	<b>Solis-26</b>	
	<b>Make</b>	Mitsubishi Heavy Industries, Ltd.	
	Engine Type	3 Cylinder, 4 Stroke, Naturally Aspirated Water Cooled, Vertical overhead valve	
	Model and Identification	S3L2	
	Bore x Stroke	78 mm x 92 mm	
	Firing order	1-3-2	
	Displacement (cc)	1.318 Litres	
	Compression ratio	22:1	
	Injection timing	17° BTDC	
	Engine Rated speed	2700 rpm	
	Low Idling	1000±25	
	Valve Clearance Intake (mm) / Exhaust (mm)	0.25 / 0.25	
<b>LUBRICATION</b>	Total Engine Lub. Oil capacity (l)	4.2 Litres	
<b>TRANSMISSION</b>	Clutch Type	Single Clutch, Mechanical (Ø224)	
	Gearbox Type	Sliding Mesh (6+2)	
<b>BRAKES</b>	Type	Oil Immersed Brakes	
	Minimum radius of turning circle With Brake (m) / Without Brake (m)	2.098 / 2.980	
<b>STEERING SYSTEM</b>	Mechanical / Power	Power Steering	
<b>P.T.O.</b>	Power take off	Type	Type-I
		PTO Speeds	540@2080ERPM, 540E@1410ERPM, 1000@1515ERPM
<b>TYRES</b>	Front Tyre Size	6.00 x 12	
	Rear Tyre Size	8.30 x 20	
<b>OVERALL DIMENSIONS (mm)</b>	Wheel base	1560	
	Front Wheel Track	894	
	Rear Wheel Track	825	
	Length	2705	
	Width	1058	
	Height	1300 (upto steering wheel), 2153 (upto ROPS)	
	Ground Clearance	320	
	Total mass (Front/Rear reactions)	1020 Kg (Frt: 420 Kg, Rear: 600 Kg)	

Note: All dimensions & specifications are for guidance purpose only & are subjected to change without prior notice.

# TECHNICAL SPECIFICATIONS

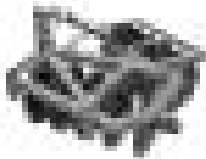



## IMPLEMENTS SPECIFICATIONS

Sr. No.	Implements	Parameter	Size	Gear	ERPM
1.	Rotavator 	Maximum no. of blades-Lblade,Jblade Maximum Width L or J Blade - cm (in) Length of one L-blade - cm (in) Height of one L-blade - cm (in) Maximum weight - kg (lbs.)	20,28 105 (41.3) 7 (2.8) 0.6 (0.23) 150 (330)	L1,L2,L3	2000-2100 540PTO-1 RPM @ 2080 ERPM
2.	Cultivator (Spring loaded) 	Maximum no. of tynes Maximum height of cultivator from ground - cm(in) Maximum Width - cm(in) Width of one tyne - cm(in) Height of one tyne - cm(in)	7 45 (17.7) 145 (57) 5 (1.9) 8.5 (3.3)	H1	2100-2500
3.	Disc Harrow 	Maximum no. of discs Maximum Width - cm (in) Disc diameter - cm (in) Maximum weight - kg (lbs.)	5x5 83 (33) 46 (18) 130 (286)	H1	2100-2500
4.	Sprayer 	Maximum tank capacity - Lts (U.S. gals)	600 (160)	H1	2000-2100 540PTO-1 RPM @ 2080 ERPM
5.	Trailer 	Dimensions of trolley(LXBXH) - cm (in) Height of trolley from ground, with trolley tyre size-105/80R14 - cm (in) Maximum gross weight - kg (lbs.)	180x90x50 (70.9x35.4 x19.7) 180 (70.9) 2000 (4400)	H3	As per customer practice

Note: Implement size/ERPM (Engine RPM) & gear selection may vary as per geographic conditions

# TECHNICAL SPECIFICATIONS

## IMPLEMENTS SPECIFICATIONS

Sr. No.	Implements	Parameter	Size	Gear	ERPM
6.	Rear Lawn Mower 	Maximum cutting width - cm (in) Maximum weight - kg (lbs.)	122 (48) 130 (286)	H1,H2	2000-2300
7.	Flail Mower 	Maximum cutting width - cm (in)	110 (43.3)	H1,H2	2000-2300
8.	Rotary Cutter 	Maximum cutting width - cm (in) Maximum weight - kg (lbs.)	110 (43.3) 130 (286)	H1,H2	2000-2100 540PTO-1 RPM @ 2080 ERPM
9.	Box Blade 	Maximum cutting width - cm (in) Maximum weight - kg (lbs.)	125 (49.2) 150 (330)	H1,H2	2000-2300
10.	Bottom Plough 	Maximum Size - in	14x1	L1,L2,L3	2000-2300





## **CHAPTER - 7**

### **DO'S AND DON'TS**



# DO'S AND DON'TS

## Do's and Don'ts

### DO'S

#### ENGINE

##### a. General

1. Do release the starter key once the engine has started.
2. Do check the proper functioning of oil pressure gauge and battery charging indicator once the engine has started.
3. Do get the tightness of cylinder head and manifold nuts checked regularly.

##### b. Air inlet System

1. Do inspect the element precleaner / oil bath. Clean if necessary.

##### c. Fuel System

1. Do drain sediments from the fuel tank periodically
2. Do clean fuel tank thoroughly once in every 500 hrs.
3. Do change filter regularly as recommended in service schedule.
4. Do fill diesel in the tank at the end of the day's work so as to avoid condensation.
5. Do ensure that pull to stop cable/knob is not in pulled condition.

##### d. Water cooling System

1. Do ensure that radiator is always filled with clean (soft) water & radiator cap is tight
2. Do clean the radiator front grill to ensure free flow of air when the engine is operating.
3. Do ensure proper tension of fan belt. Deflection should not be more than (10 mm) when pressure is applied between the fan pulley and the crankshaft pulley.

##### e. Lubrication System

1. Do replace engine oil after first 50hrs. of operation. Thereafter, engine oil should be replaced every 250 working hrs.
2. Do check oil level daily with tractor parked on a level ground.
3. Do replace lub. oil filter element every 250 working hrs. After 1st replacement at 50 hrs.

#### CLUTCH

1. Do ensure that clutch free pedal play is between 25 to 30 mm.
2. Do ensure that the clutch pedal is released slowly while moving the tractor.

### DON'T'S

#### ENGINE

##### a. General

1. Do not keep on continuously cranking the engine with starter key. It will shorten the life of battery.
2. Do not race the engine in neutral condition.

##### b. Air inlet System

1. Do not run the tractor if the air cleaner assembly is defective as this will lead to impure air being taken in and consequently excessive wear of liners and piston rings.

##### c. Fuel System

1. Do not keep the fuel tank without a proper sealing cap.
2. Do not use contaminated fuel as it may affect the operation of fuel injection pump and the injectors.
3. Do not allow leakage through fuel pipe joints.

##### d. Water Cooling System

1. Do not run the tractor with the radiator cap removed/non-acting radiator cap.
2. Do not run the tractor when the radiator hoses are leaking as it will lead to overt heating of the engine.
3. Do not remove thermostat as it will affect engine performance.
4. Do not run the belt tight as it will lead to premature failure of water pump and alternator bearing.
5. Do not run the belt loose as it will lead to inefficient cooling and improper charging of the battery.

##### e. Lubrication System

1. Do not use wrong grade of lubrication oil.
2. Do not mix different brands of engine oil.

##### f. Exhaust System

1. Do ensure that the exhaust passage is not blocked.

#### CLUTCH

1. Do not rest the foot on the clutch pedal.
2. Do not work the tractor by slipping and re-engaging the clutch.
3. Do not coast down steep slopes with tractor in neutral/with clutch pedal pressed.

# DO'S AND DON'TS

## DO'S

### TRANSMISSION

1. Do change the transmission oil after 1000 hrs. of operation.
2. Do check the condition of rubber protection bellows on the gear levers periodically as they prevent infiltration of water and dust into gear box.

### HYDRAULIC SYSTEM & LINKAGE

1. Do ensure that hydraulic control lever is in down position while draining the transmission oil.
2. Do ensure that the hydraulic strainer is cleaned at every schedule.
3. Do adjust the top link for proper length.
4. Do ensure that the lift cover bolts are always tight.
5. Do keep the lower links in lifted position when the tractor is moving without an implement mounted on it.
6. Do keep the ball joints on top and lower links clean and dry. Do not lubricate them.
7. Do ensure that implements are raised and lowered using the control lever.

### BRAKING SYSTEM

1. Do keep the brake pedals locked with interlocking latch when the tractor is not being used in field.
2. Do use parking brakes when the vehicle is stationary
3. Do check loose connections in linkage mechanism
4. Do grease brake pedal bush, brake bracket connections.

### FRONT AXLE & STEERING MECHANISM

1. Do lubricate the Bushes and steering drag links periodically.
2. Do get the toe-in adjusted by an authorised service centre periodically. It should be maintained between (3-6 mm)
3. Do check the tightness of front and rear wheels to recommended torque (Front wheel is 72 Nm, Rear wheel 130Nm)
4. Do flush oil once a year or 1000 hrs which ever is earlier.

### TYRES

1. Do operate the tractor with correct tyre pressure. This will lead to better traction, longer tyre life and better fuel consumption.

## DONT'S

### TRANSMISSION

1. Do not use top gears with low engine rpm.

### HYDRAULIC SYSTEM & LINKAGE

1. Do not move the operational control range to fast response, while the tractor is on a hard surface like concrete, as the implement will crash down and get damaged.
2. Do not attempt to pull or tow anything from the top link connection. It is dangerous.
3. Do not use bolts in place of linch pins.
4. Do not reverse the tractor with PTO driven implement attached and PTO lever in ground PTO position implement may get damaged in reverse.

### BRAKING SYSTEM

1. Do not attempt to turn sharply using independent brakes when travelling at high speed. This may cause the tractor to overturn.
2. Do not rest foot on the brake pedal.

### FRONT AXLE & STEERING MECHANISM

1. Do not use wrong grade of oil for lubrication of steering gear box.

### TYRES

1. Do not allow oil, grease and some crop spray containing considerable amounts of acid and alkalies to contaminate the tyre. These can cause considerable damage to the tyre if they penetrate into plies through small holes or splits.
2. Do not operate the tractor with excessive tyre pressure.

# DO'S AND DON'TS

## DO'S

### ELECTRICALS

1. Do ensure that the battery terminals are kept clean.
2. Do ensure terminal base is Lubricated with petroleum jelly.
3. Do earth the tractor by wrapping a chain around the front axle, dropping one end of the chain on the ground while working with stationary PTO driven implement. This saves the electric equipment from damage due to static electricity.
4. Do clean the switches periodically using a jet of air.

### SAVE DIESEL

- Do switch off the engine when tractor is not in operation. Avoid unnecessary idling.
- Do operate at Optimum speed and correct gear.
- Do maintain the recommended tyre pressure for fuel efficient operation and long life of tyres. Check daily.
- Do use matching trailer for transportation. Ensure proper hitching. Never overload the trailer.
- Do maintain your tractor in good working condition.
- Do replace genuine parts from SONALIKA Authorised Dealers.

### For Better performance

- Ensure that safety shields are in place and in good condition.
- Read all operating instructions before commencing to operate Tractor.
- Keep the air cleaner clean.
- Fit new sealing rings when the filter elements are changed.
- Watch the oil pressure gauge or warning light and investigate any abnormality immediately.
- Ensure that the transmission is in neutral before starting the engine.
- Keep all fuel in cleans storage and uses a filter when filling the tank.
- Attend to minor adjustments and repairs as soon as the necessity is apparent.
- Allow the engine to cool before removing the radiator filler cap and adding water, remove the radiator cap slowly.
- Shift into low gear when driving down steep hills.
- Latch the brake pedals together when driving on a highway.

Ensure daily care of your tractor to avoid breakdowns.

## DONT'S

### ELECTRICALS

1. Do not change leads of the battery terminals as this will lead to failure of electrical components.
2. Do not leave the battery leads in the connected position if the tractor is not going to be used for a long period of time.
3. Do not overfill the battery with distilled water. The level should be just enough to submerge the battery plates.
4. Do not do any welding in the tractor without disconnecting Battery terminals.

### EVERY DROP COUNTS

- Do not allow fuel or oil to leak. Ensure that the joints are adequately tight.
- Do not spill fuel or oil while filling or topping up. Use a funnel.
- Do not overfill engine oil as this can cause excessive oil consumption and oil leaks.
- Do not overfill engine oil as this can cause excessive oil consumption and oil leaks.
- Do not ride the clutch or brake pedal.
- Do not allow the rear wheel to slip. Use ballast, if necessary.
- Do not use worn-out tyres.
- Do not use inferior quality lubricants, use only recommended grade.

### For safe operation

- Do not Run the engine with the air cleaner disconnected.
- Do not Start the tractor in an enclosed building unless the doors and windows are open for proper ventilation.
- Do not Operate the tractor or engine while lubricating or cleaning.
- Do not Temper with the fuel injection pump, (if the seal is broken) the warranty becomes void.
- Do not Allow the engine to idle for a long period.
- Do not Use the independent brakes for making turns on the highway or at high speeds.
- Do not Refuel the tractor with the engine running.
- Do not Start the engine with the PTO engaged.

Carefully read and follow the other instructions given in the Do's and DON'Ts maintenance booklet, to ensure maximum saving of oil/fuel.



## **CHAPTER - 8**

# **TROUBLESHOOTING**





# TROUBLESHOOTING

## Troubleshooting

PROBLEM	POSSIBLE CAUSE	REMEDY
<b>ENGINE</b>		
<b>Engine not starting</b>	Wrong way of starting engine	Use proper way of starting
	No fuel	Check Fuel level
	Air trapped in fuel system	Bleed the fuel system
	Checking of fuel system	Contact your dealer
	Fuel injector faulty	Replace
	Pull to lever knob in pulling condition	Return it to its proper position
	Fuel filter choke	Replace filters
<b>Engine not running in proper way</b>	Fuel filter choke	Replace filters
	Low quality of oil	Drain diesel from tank and fill clean diesel
	Choking of fuel system	Check fuel system
	Fuel injectors faulty	Replace fuel injector
<b>More oil consumption</b>	Oil level is more than maximum level	Keep oil level up to mark
	Oil quality is not good	Use genuine oil
<b>Engine not giving maximum power</b>	Leakage of oil	Check and repair
	Heavy load on engine	Decrease load or shift in low gear
	Air cleaner dirty	Clean air cleaner
	Fuel filter choke	Replace filter
	Engine overheating	Check cooling system
	Engine operating temperature is less	Check thermostat
	Valve clearance not proper	Adjust through authorized dealer.
	Throttle system not working properly	Check & repair through authorized dealer.
<b>Engine abnormal noise</b>	Oil level less	Top up
	Oil pressure less	Check through authorized dealer
	Engine is overheated	Check and find reason
	Improper tappet setting	Adjust through authorized dealer
<b>Oil pressure Indicator shows warning</b>	Oil level is less	Top up oil up to level
	Oil quality is not good	Use genuine engine oil
	Oil pump not working	Check and repair through authorized dealer
<b>Engine Over Heating</b>	Radiator cap faulty	Replace with new one
	Choked radiator fins	Clean it
	Engine gets overload	Decrease load or shift to low gear
	Oil level is less	Top up to level
	Coolant level is less	Check level and leakage of system and top up
	Slippage of fan belt	Check belt tension
	Thermostat faulty	Replace
	Choking of cooling system	Clean the cooling system
Water temp. Gauge not working	Check through dealer and faulty replace	

# TROUBLESHOOTING

PROBLEM	POSSIBLE CAUSE	REMEDY
<b>ENGINE</b>		
<b>More Fuel Consumption</b>	Air cleaner is dirty / choked	Clean air cleaner
	Overloading of engine	Reduce load or shift to low gear
	Improper valve clearance	Check and adjust
	Implement setting improper	Adjust it and take instrument from dealer for right
	Less engine temp	Check injectors and service
	Fuel injection nozzle faulty	Check and service through dealer
<b>HYDRAULIC</b>		
<b>Excessive Heating of Oil</b>	Improper inflation pressure	Check and adjust according to specified
	Oil level is high or less	Check and maintain proper level
	Hydraulic Strainer choked	Clean/Replace
	Mechanical linkage may faulty	Contact your authorized dealer
<b>Linkage Goes Down Slowly</b>	Bush tight	Contact your authorized dealer
	Response valve setting improper	Contact your authorized dealer
<b>Linkage Not Lift Fully</b>	Improper lift arm setting	Contact your authorized dealer
	Improper internal adjustment	Contact your authorized dealer
<b>TPL Not Respond To Lifting While Operating Hydraulic Lever</b>	Linkage connection not joint properly	Contact your authorized dealer
	Heavy load on linkage	Contact your authorized dealer
<b>Hydraulic System Not Working Properly</b>	Response valve setting very low	Check valve by your dealer.
	Oil level low	Check and top up
	Hydraulic Strainer choked	Clean/Replace
	Hydraulic system faulty	Check through authorized dealer
	Hydraulic pump not working	Contact your authorized dealer
<b>BRAKES</b>		
<b>Noise While Applying Brakes Tractor Goes in One Side</b>	Wrong adjustment of brakes	Check
	Both brakes are not set properly	Adjust
<b>Brakes Works When Fully Pressed</b>	Wrong adjustment of brake pedal	Check and Adjust.
<b>ELECTRICAL</b>		
<b>Electrical System Not Working</b>	Battery terminal loose or rusting of terminal	Clean and tight the terminals
	Less specific gravity	Replace or fill electrolyte up to level
<b>Starter Motor Not Working.</b>	Battery terminal loose / Battery discharged	Tightened / Recharge or replace battery
	Faulty starter motor	For repair contact your dealer
<b>Battery Not Charging</b>	Loose or rusted terminals	Clean and tight terminal
	Belt loose	Check belt tension
	Faulty battery	Replace

## **CHAPTER - 9**

### **SERVICE RECORD**

### **INSTALLATION CERTIFICATE**





# INTERNATIONAL TRACTORS LIMITED

Vill. Chak Gujran, P.O. Piplanwala, Jalandhar Road, Hoshiarpur

## TRACTOR INSTALLATION CERTIFICATE

TRACTOR DETAILS		OWNER'S DETAILS			
Engine No	_____	Name	_____		
Chassis No:	_____	Address	_____		
FIP No.	_____	Phone No	_____		
Gear Box No.	_____	Tractor Model:-	_____		
Alternator Make and No.	_____	Invoice Number:-	_____		
Hydraulic Pump No.	_____	Invoice Date:-	_____		
Battery Make and No.	_____	Invoice Value:-	_____		
Tyre Details (Sr. Nos) :-		Details of other tractor owned (if any)	_____		
Front : Left _____ Right _____					
Rear : Left _____ Right _____					
LIST OF INSTRUCTIONS TO BE UNDERSTOOD AND FOLLOWED					
S.No	Instructions	Tick here			
1	Use of Operator's handbook				
2	Location & Significance of Engine No. Chassis No. etc				
3	Starting and Stopping Procedure				
4	Safety Precautions to be observed				
5	Use and adjustment of Clutch & Brake Pedals				
6	Running of New Tractor for first 100 hrs				
7	Maintainence of correct Tyre Pressure				
8	Operation of Hydraulic System & Adjustment of three point linkage & Mast height setting				
9	Selection of proper gears for different jobs and method				
10	Attachment & Detachment of Implements/Use of lift lock for transportation implements				
11	Setting of Wheel Track width for different crops				
12	Hitching of Trailer/Trolley & Use of Accessories				
13	Lubrication Points and correct grade of lubricants				
14	Periodic Replacement of fuel filters, oil filters, hydraulic filter				
15	Procedure for bleeding Fuel System				
16	Proper handling and storage of fuel				
17	Maintainence of Cooling System, Fan Belt Adjustment				
18	Maintainence of Electrical Equipments				
19	Tightening of bolts and nuts				
20	Daily and Weekly Maintainence Schedule				
21	Terms and conditions of warranty				
22	Availing of Free Service from Authorised Dealer				
<i>Upload Photograph of Customer with Tractor &amp; Impliments taken during installation</i>		Major Application (✓)		Accessories received (✓)	
		Cultivation		Drawbar	
		Rotavator		Bumper	
		Haulage		Hook	
		Genset		Top link	
		Loader Dozer		Tool kit	
		Grass cutter		Operator manual	
				Front Weights	
		Wheel Weights			
<i>I hereby certify that I have understood all the instructions mentioned in this Certificate regarding Tractor maintenance and Proper use of all controls. I understand that Warranty starts from today, whose terms and conditions have been explained to me and are acceptable to me. I have carefully read all the instructions necessary for maintainence and proper use of Tractor. I will follow all the instructions, failing which my Warranty will stand cancelled.</i>					
Dealer representative Name & Signature			Customer Name & Signature		
Dealership Name:-			Installation Date:-		
Dealership Phone No.			Dealership Address:-		



# SERVICE RECORD

CH. NO. \_\_\_\_\_ ENGINE NO. \_\_\_\_\_

S. NO.	DATE/HMR	DEALER CODE	BRIEF JOB DESCRIPTION	ACTION TAKEN	DEALER SIGN

**TO ENSURE  
LONG AND EFFICIENT  
SERVICE FROM YOUR TRACTOR**

**USE ONLY**

**GENUINE SPARE PARTS  
&  
RECOMMENDED LUBRICANTS**