

# 1

## *Disassembling gearbox 2 Wheels Tractors and Mowers*



**PASQUALL**



**FERRARI**

## 2

### *Disassembling gearbox 2 Wheels Tractors and Mowers*

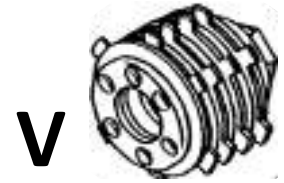
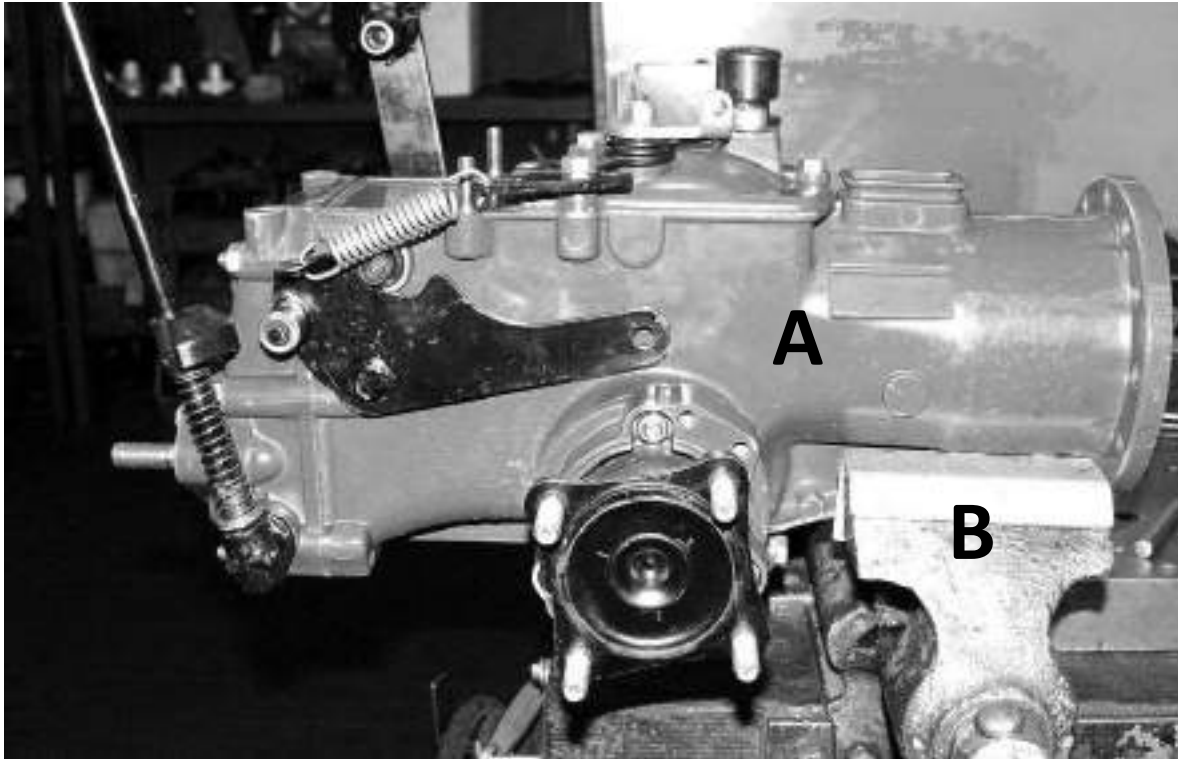

***Before** disassembling the gearbox dismount the engine, the rods, the wheels, detach the cables and the handlebar, remove drums, strains and the semi-flanges (right and left) of the brakes, flow out the oil, lock the gearbox **A** in a clamp **B** as shown. In some old models take out the clutch with disks **V**, or with double cone **W**. To change the PTO oil seal or oil seal side clutch see table 3.*

### 3

## Disassembling gearbox 2 Wheels Tractors and Mowers

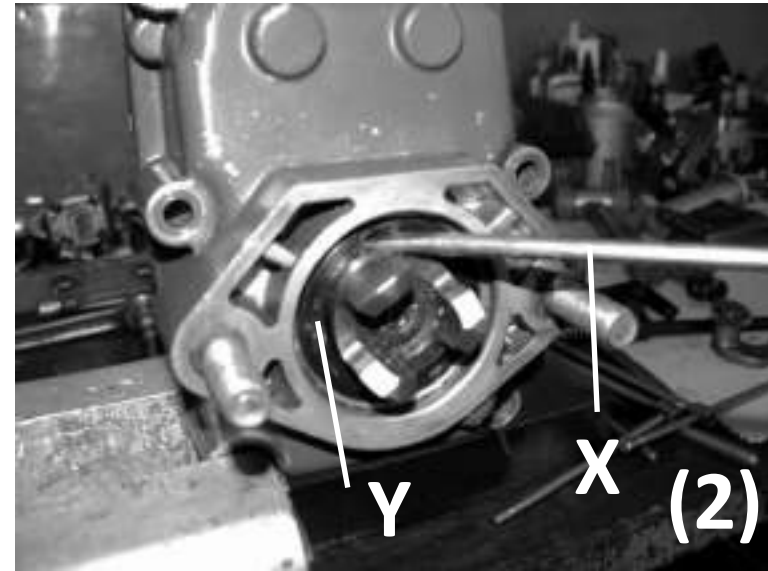
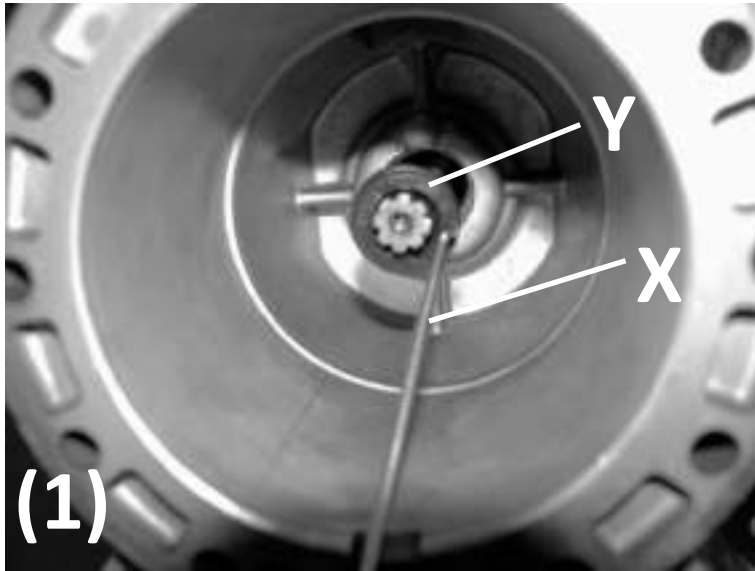

***In this phase***, before the complete dismount, is possible change the oil seal in the side of the clutch (1) or the oil seal of the PTO (2), pay attention to not damage the aluminum housings and proceed as follows: between shaft and oil seal introduce the hook X, hook the oil seal Y and pull out it until it is out of its housing, remounting a new oil seal is necessary to lubricate with grease and turn slowly on the shaft until it is put on its housing. ***In some old models, to change the oil seals open the gear box, proceed as by next tables.***

# 4

## Disassembling gearbox 2 Wheels Tractors and Mowers

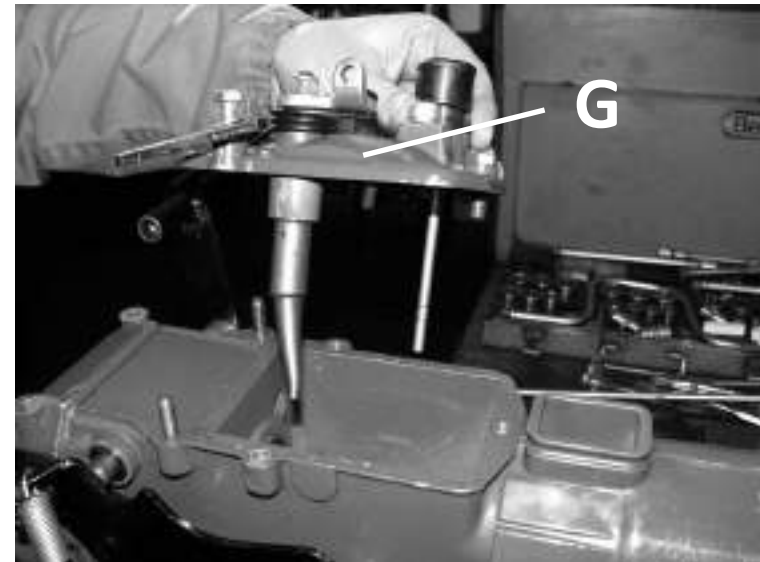
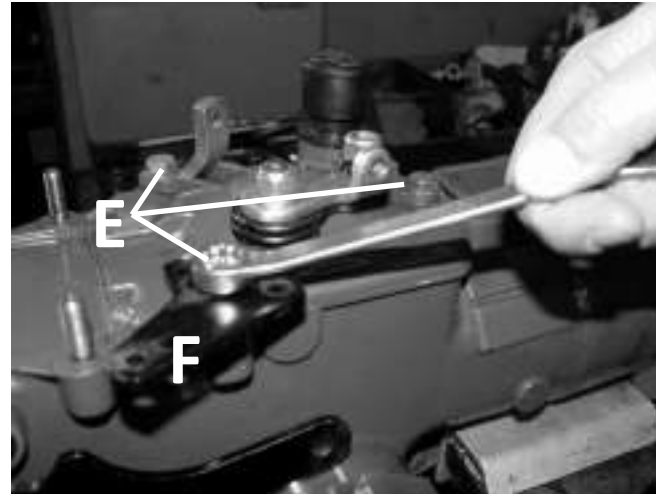
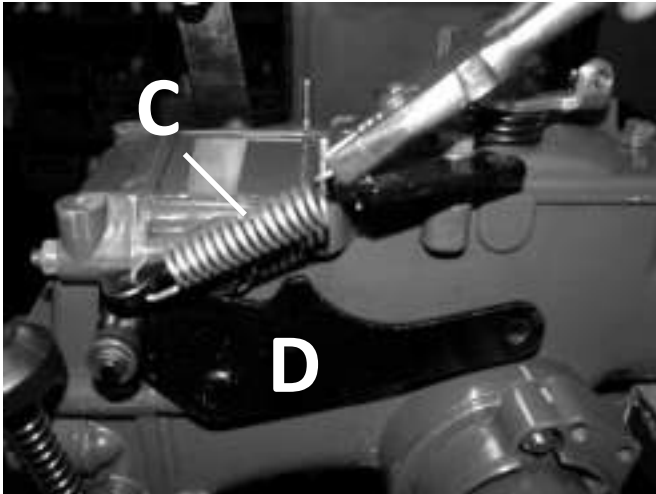

*In this phase, before the complete dismount, open the top cover and verify inside the gearbox, final transmission or differential lock coupling: detach the spring **C** of the reverse speed lever **D**, unscrew the screws **E** and remove the attach **F**, raise the top cover **G**.*

# 5

## Disassembling gearbox 2 Wheels Tractors and Mowers

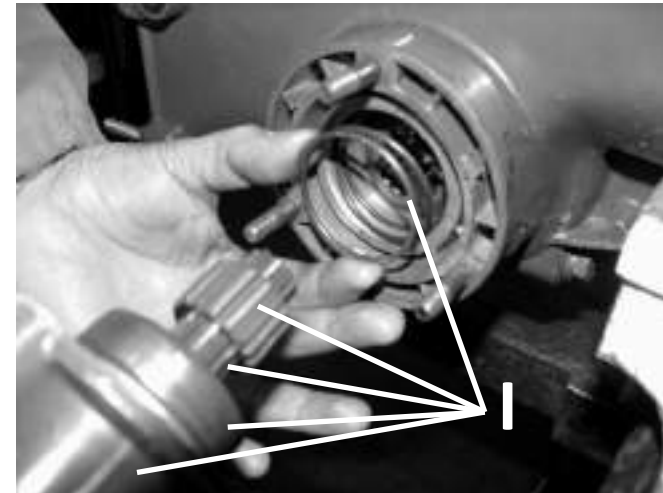
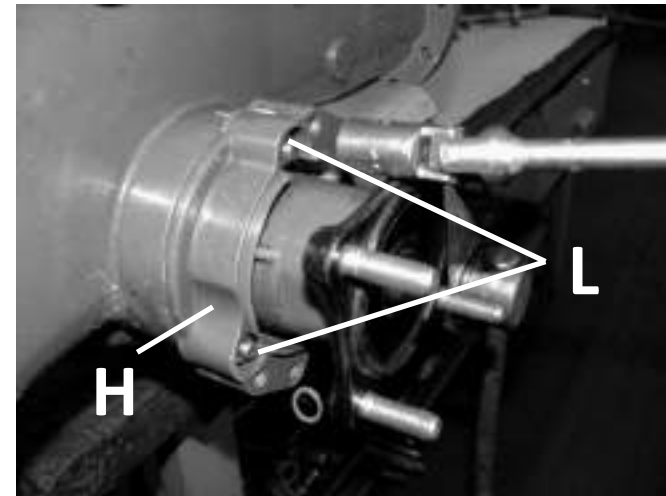
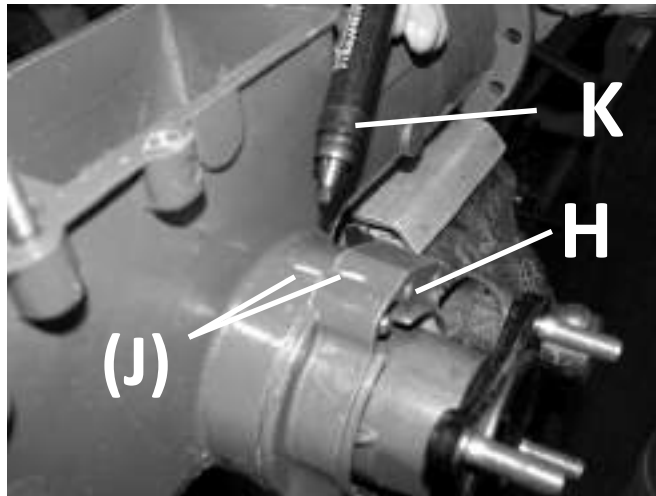

*In this phase, before the complete dismount, dismount the two semi-axes **H** (right and left), and verify or change the components **I**, or change the oil seal of the semi-axes as explained in the next table **6**. suggest to mark the position **(J)** with a marker **K**, dismount the screws **L** and remove the semi-axle **H**.*

# 6

## Disassembling gearbox 2 Wheels Tractors and Mowers

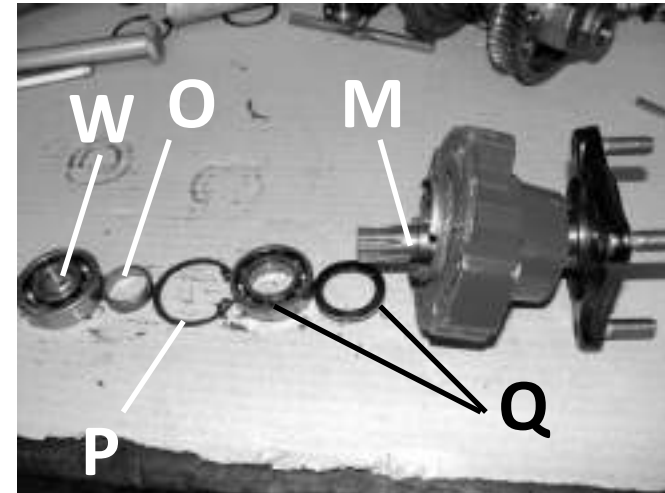
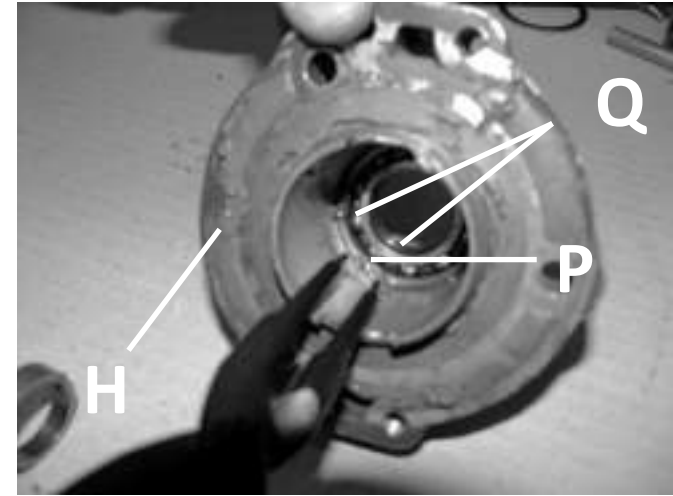
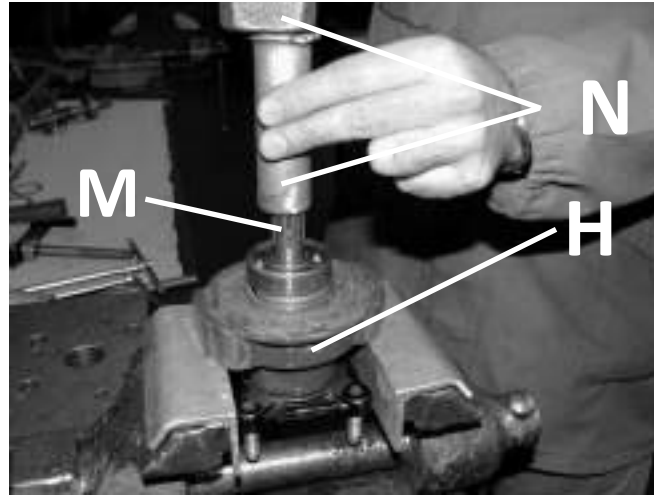
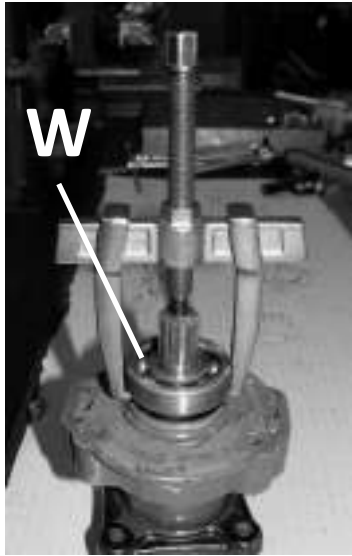

**Proceed** dismounting the bearing **W** with a standard extractor or position the semi-axle **H** on a clamp and beat the edge of the shaft **M** with a hammer and a aluminum cane **N** until the shaft come out, recover the shaft **M**, bearing **W**, the ring **O**, remove the seeger **P**, the bearing and the oil seal **Q**.

**Remounting need** to always change the ring **O** with a new one, the ring is pressed on the shaft.

# 7

## Disassembling gearbox 2 Wheels Tractors and Mowers

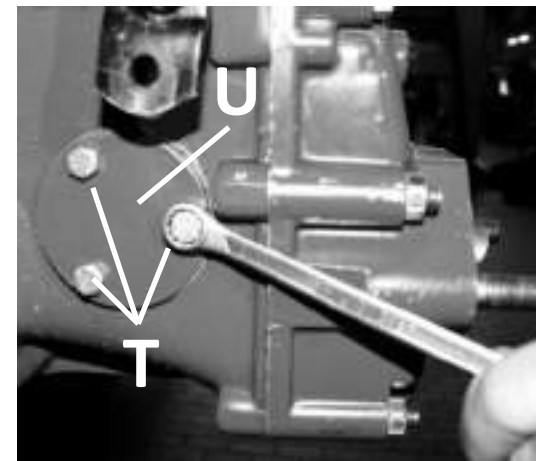
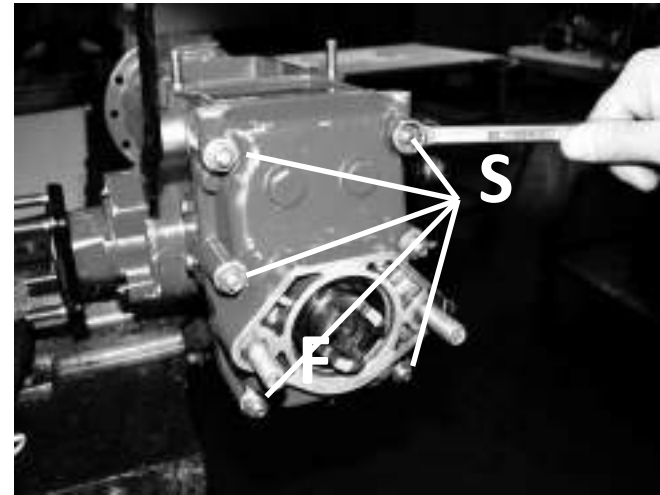
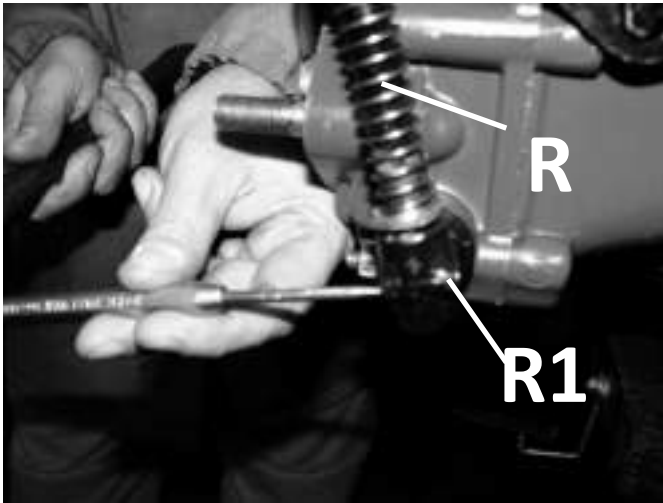

*If necessary to dismount the PTO lever **R** take out the pin **R1**, to open the gearbox proceed as follows: Take out the nuts **S** and screws **T** and remove the round cover **U**. In some models the cover **U** is also the support of the reverse gear.*

# 8

## Disassembling gearbox 2 Wheels Tractors and Mowers

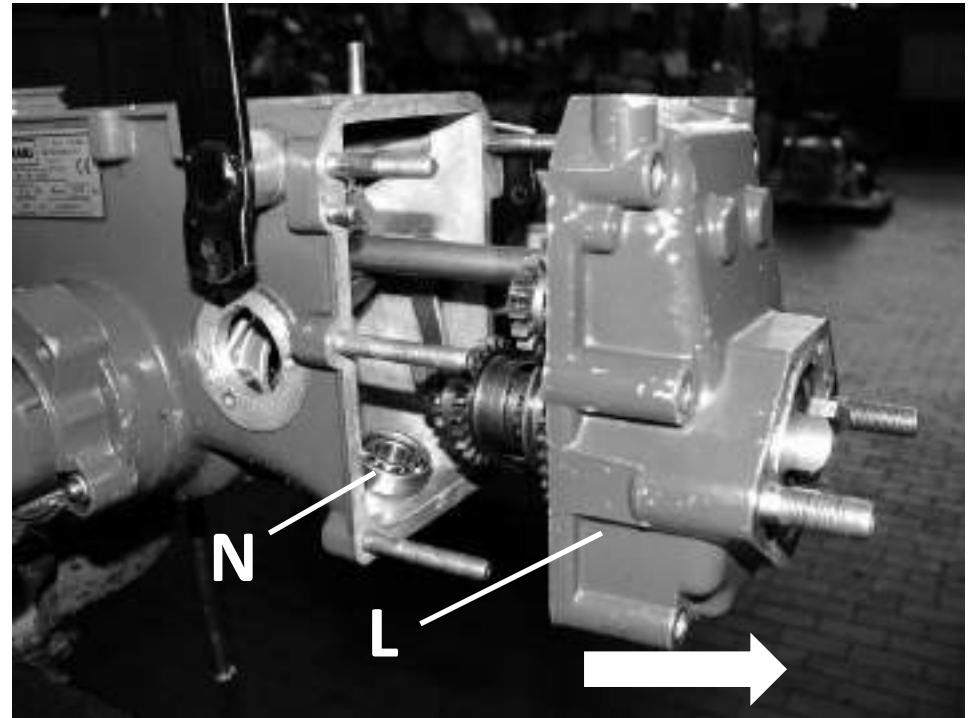
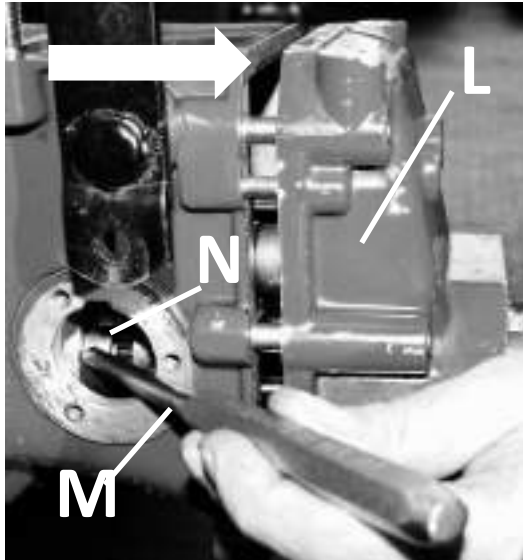

---

**Open** the PTO cover **L** as by arrow, if the cover allows. With the aid of a pin driver **M** remove the small bearing **N** from the PTO shaft, now is possible to extract the cover **L**.



# 9

## *Disassembling gearbox 2 Wheels Tractors and Mowers*

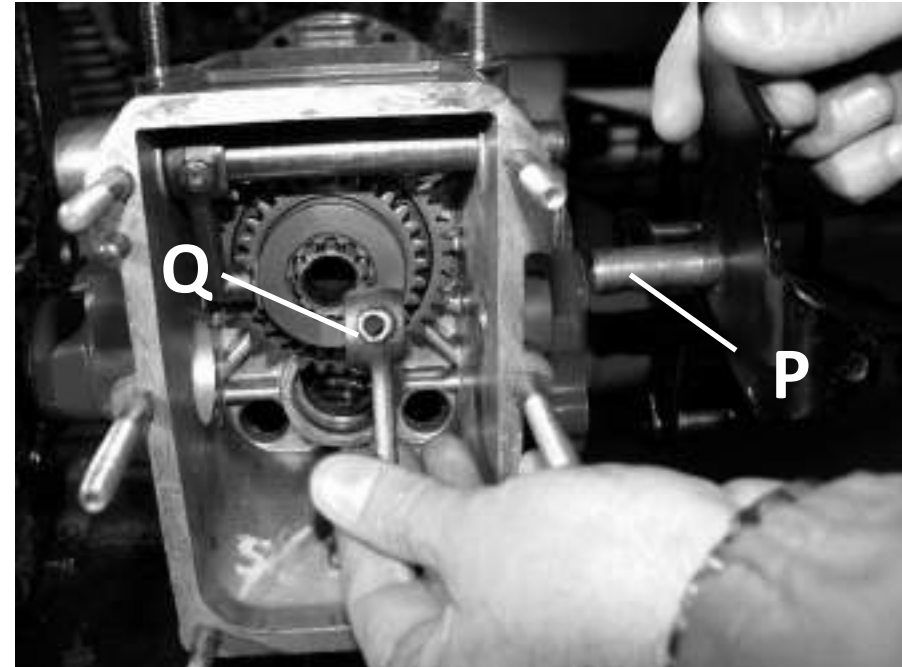
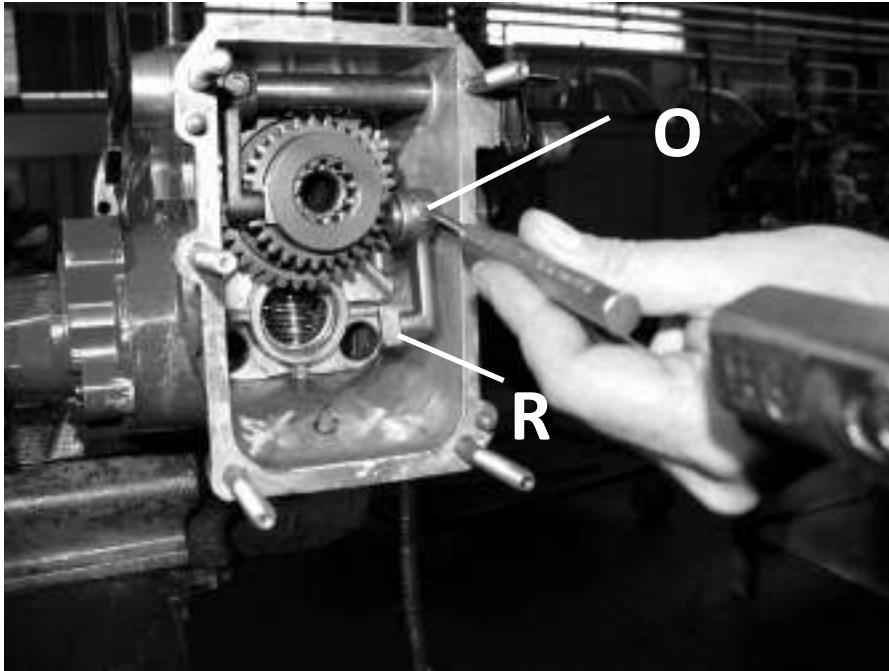

*With a pin driver pull out the pin **O** and recover it, pull out the lever **P**, the lever **Q** and the shoe **R**. **On the old model the pins are 2.***

# 10

## Disassembling gearbox 2 Wheels Tractors and Mowers

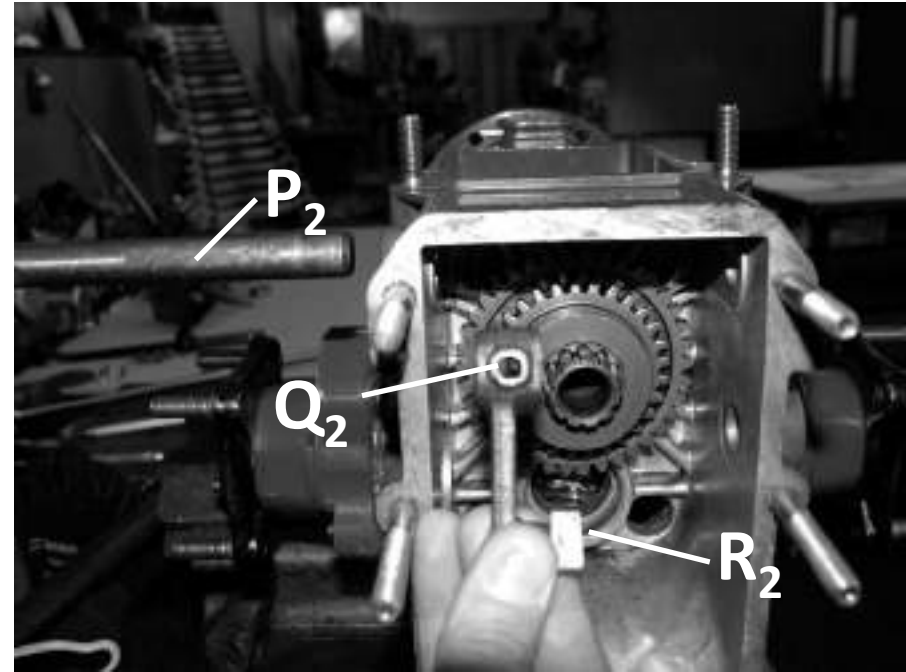
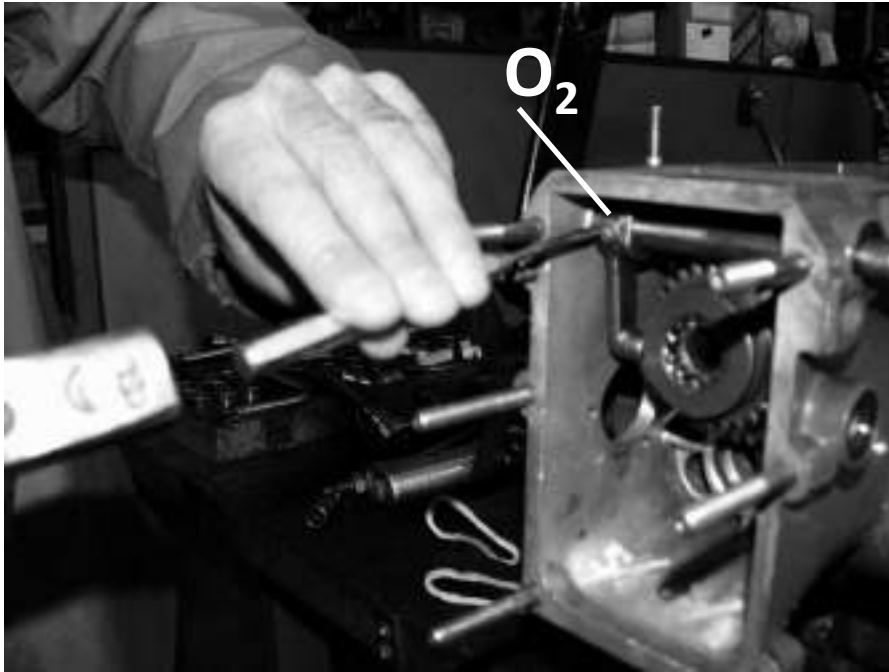

**With a pin driver** remove the pin  $O_2$  and recover it, remove the lever  $P_2$ , the lever  $Q_2$  and the shoe  $R_2$ . **On the old model the pins  $O_2$  are 2.**

# 11

## Disassembling gearbox 2 Wheels Tractors and Mowers

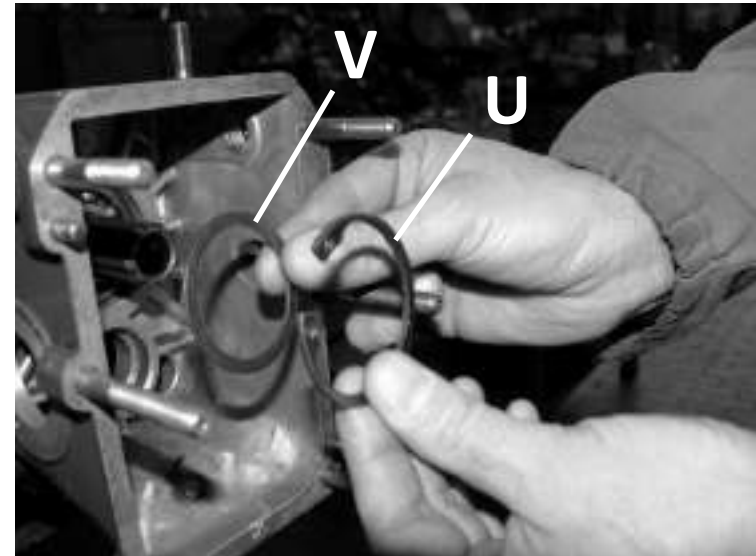
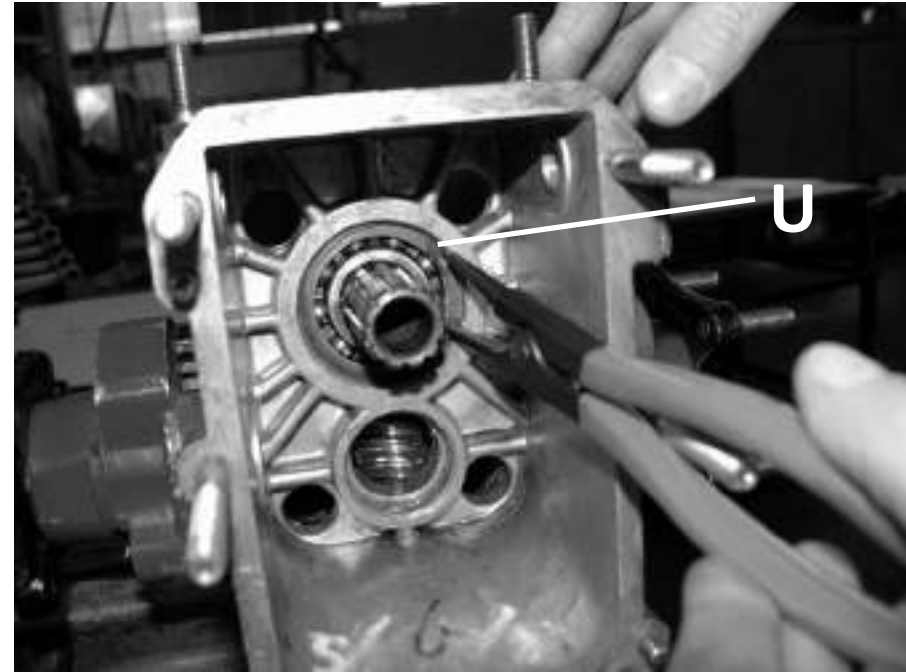
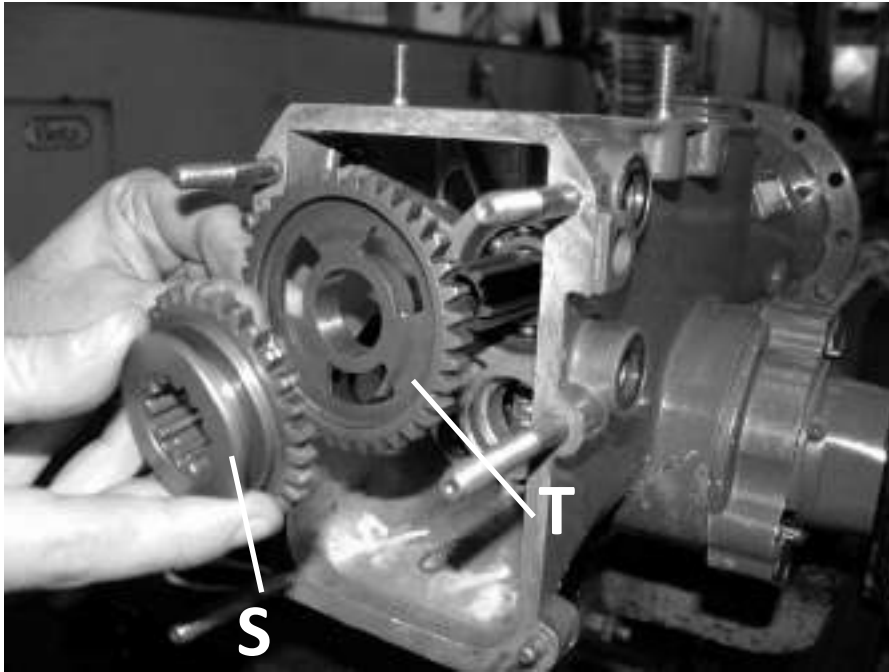

**Remove the shifting gear *S* and the 1st speed gear *T*, disengage and recover the seeger ring *U* and the spacer ring *V*. **ATTENTION**, the seeger ring *U* has a different thickness depending models. The old models have also a small ring spacer on first gear.**

# 12

## Disassembling gearbox 2 Wheels Tractors and Mowers

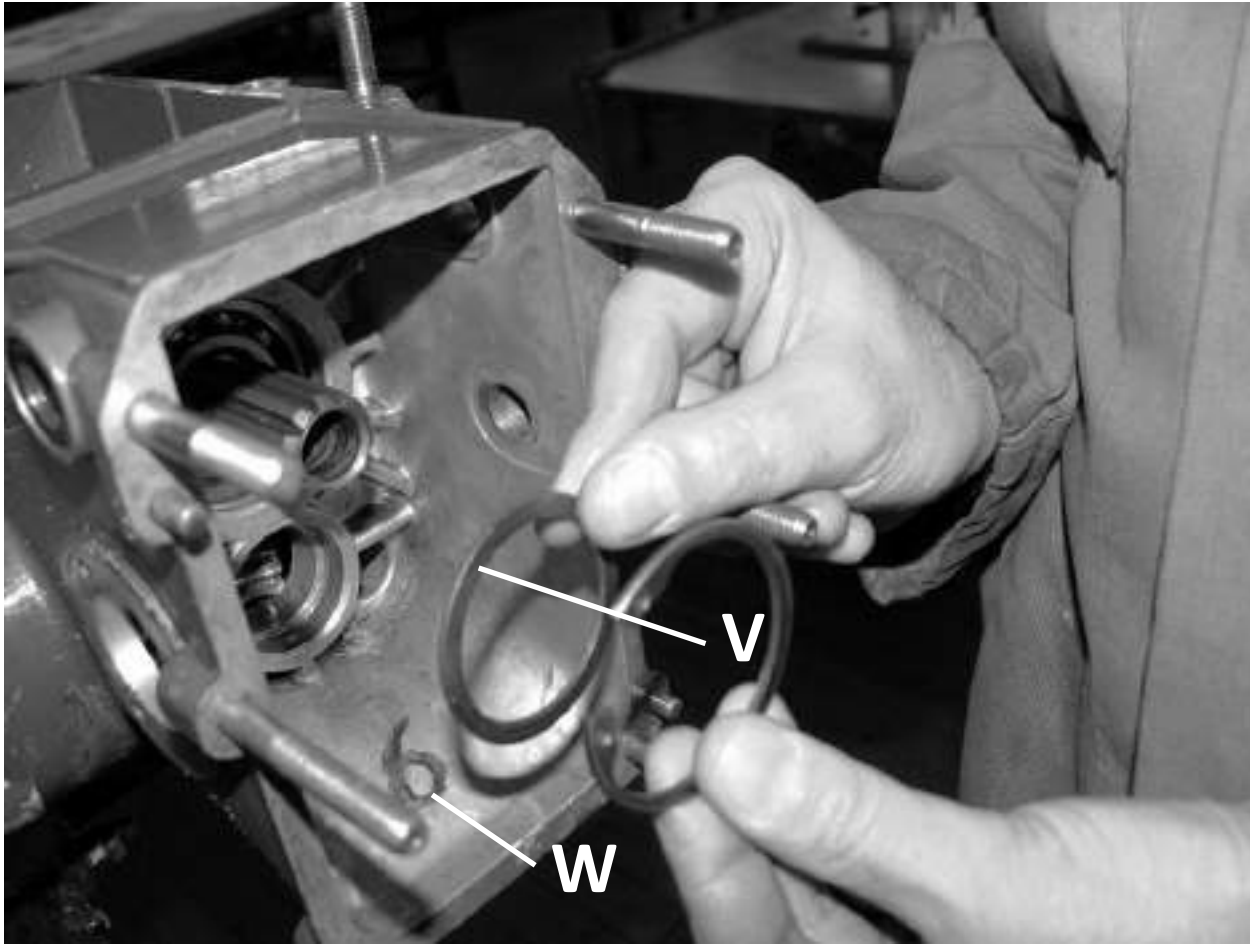

**ATTENTION:** reassembling the shimming ring **V** verify if it is correct with the measure **W** wrote inside the gearbox (6 means a shim of 1,6 mm, 5 means 1,5 mm etc.) see next page 13.

**The shimming rings V** have different measures and code, they are inside the exploded tables of the gearbox, it is important have an accurate shimming.

**Attention:** some gearboxes have thrust bearings Y mounted on the worm shaft Z, need to direct the bearings as in figure below, the arrow means the direction of the load to determine the orientation; “g” means the bigger side of the internal ring of the bearing.

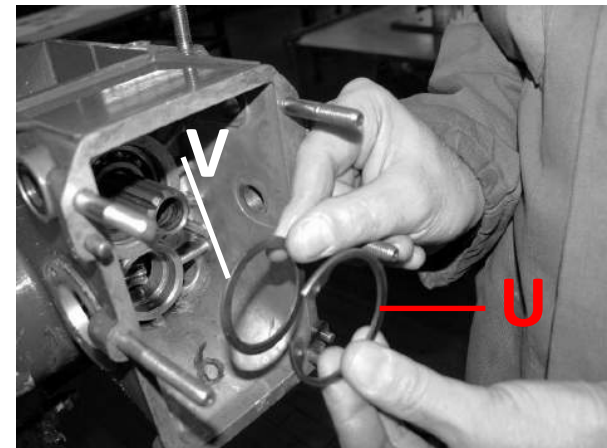
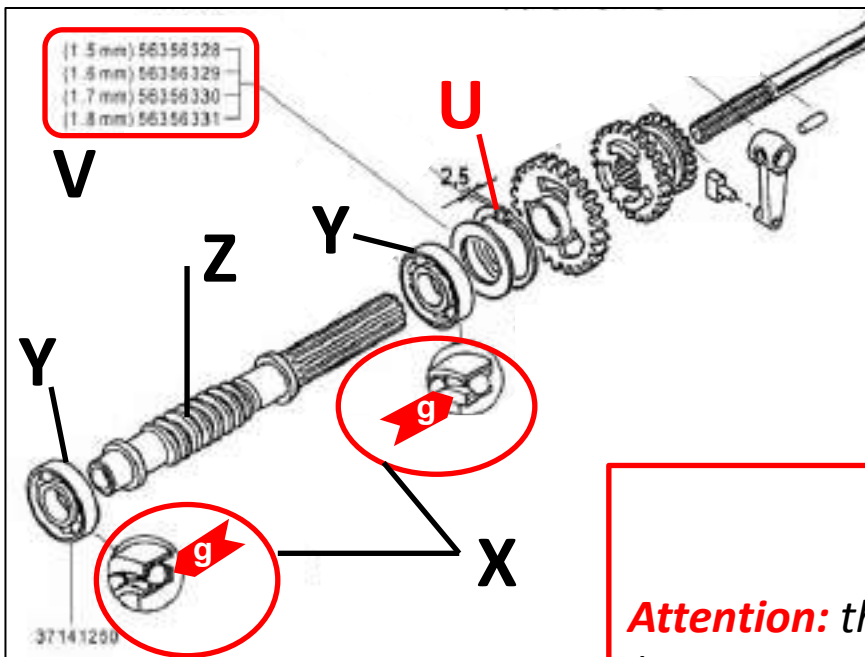

**Attention:** the seeger ring U could have different measure (2 or 2,5 mm), it depends by the housing where fitted.

# 14

## Disassembling gearbox 2 Wheels Tractors and Mowers

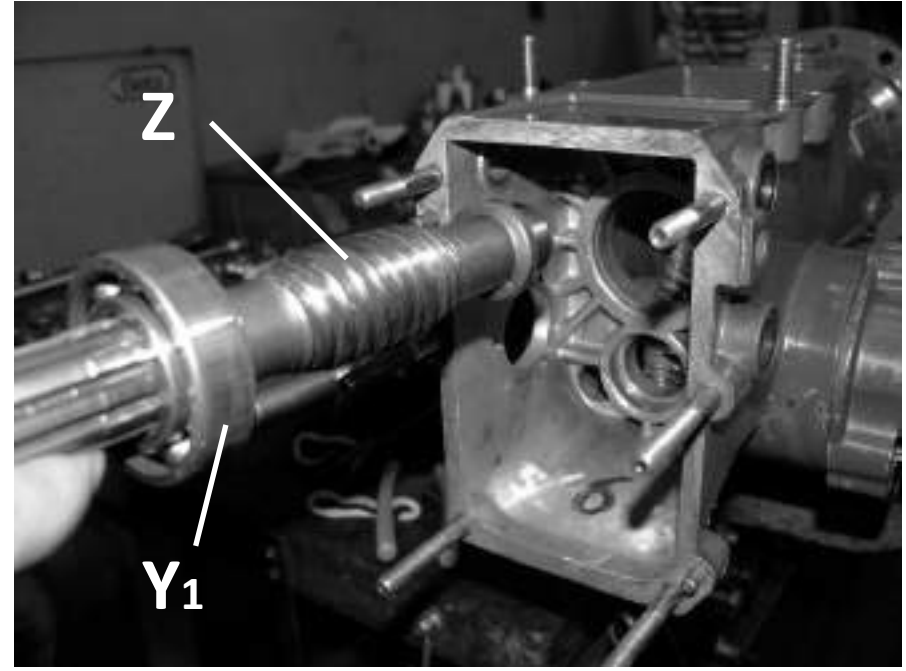
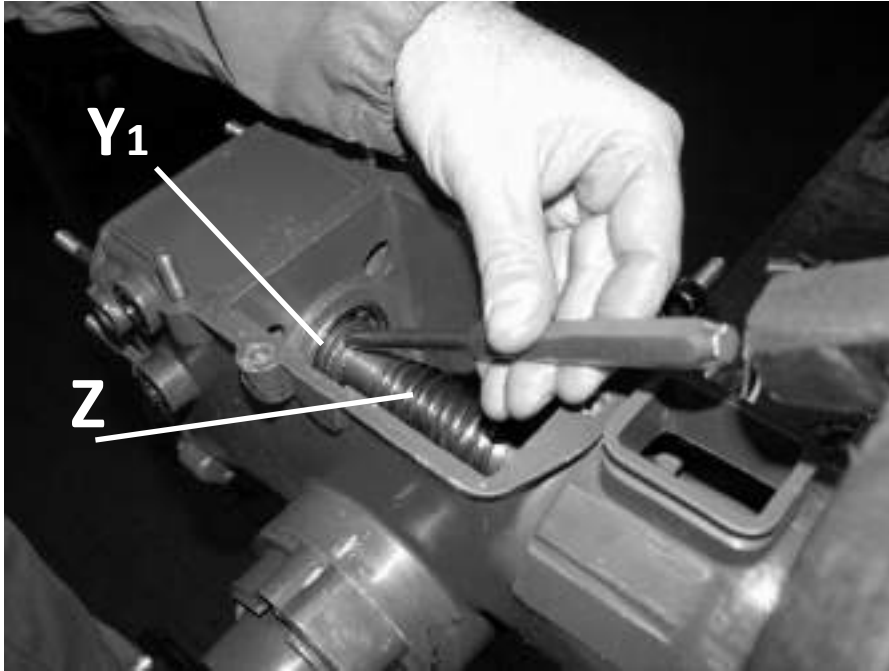

**Proceed** to dismount the worm shaft **Z** and the bearing **Y<sub>1</sub>** of the gears side with the aid of a pin driver as shown, then remove the bearing **Y<sub>2</sub>** of the engine side and the oil seal in the old models.

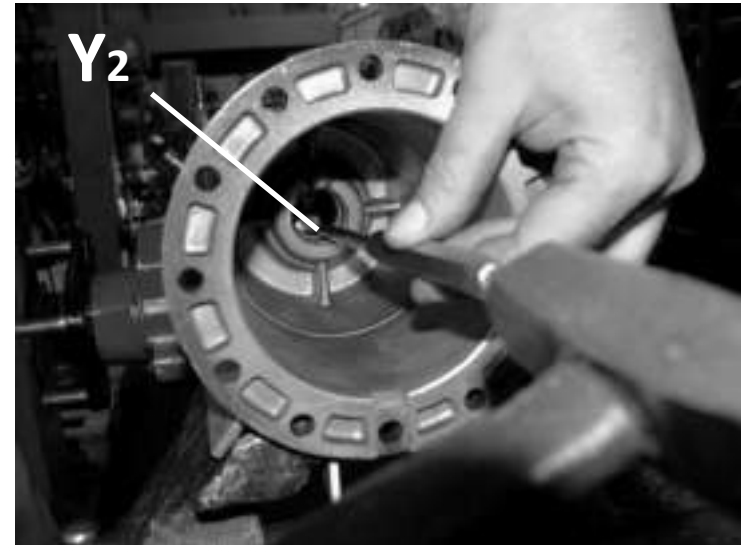

## Disassembling gearbox 2 Wheels Tractors and Mowers

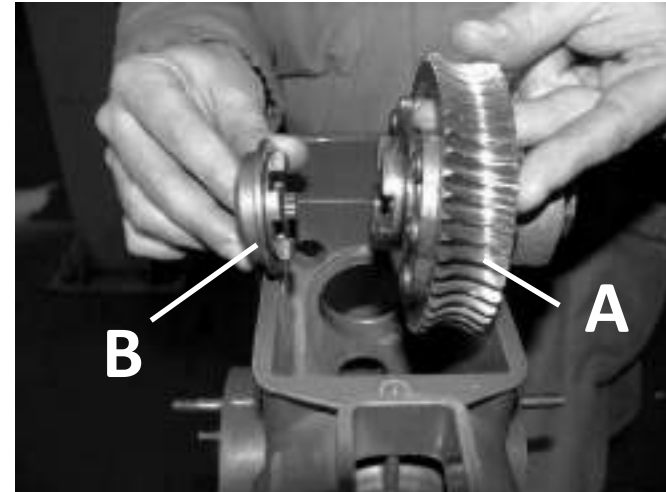
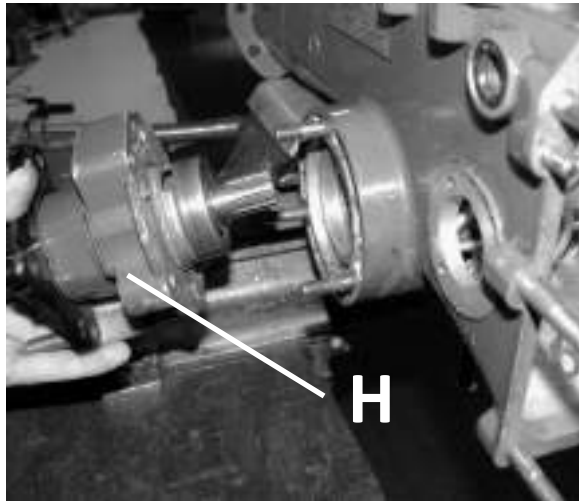

**Remove** the semi-axles right and left **H** if not already removed following the instructions of the pages 5 and 6, then remove the differential gear **A** and the coupling **B** of the differential lock.

**Remove** the nut **C** and recover the shaft and the spring **D**.

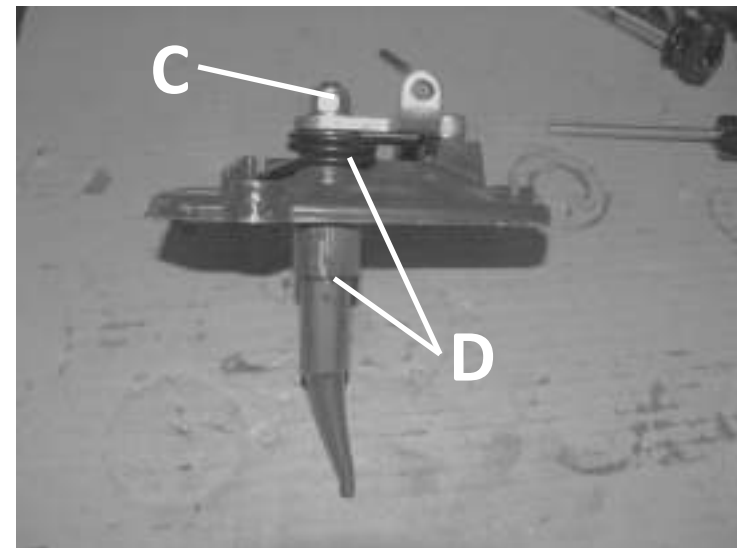

# 16

## Disassembling gearbox 2 Wheels Tractors and Mowers

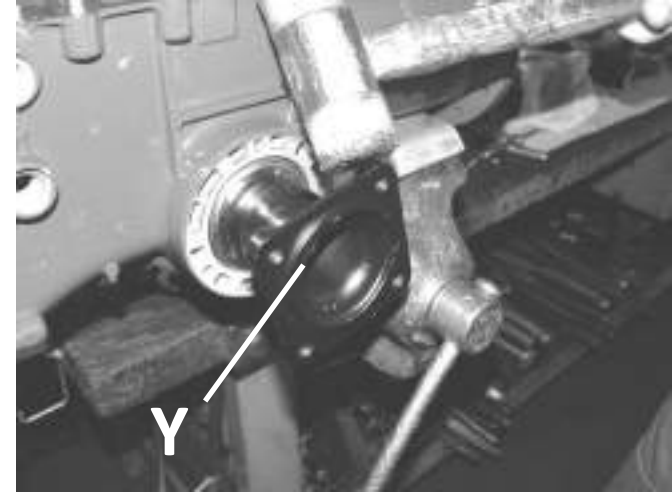
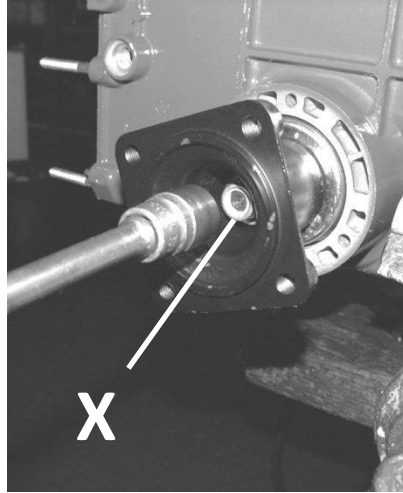
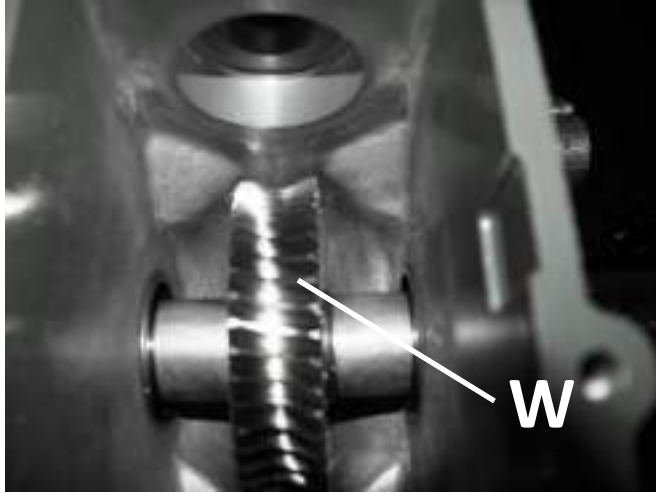

*For the models without differential, to dismount the bronze crown **W** need unscrew the nut **X** and remove the hub **Y**.*

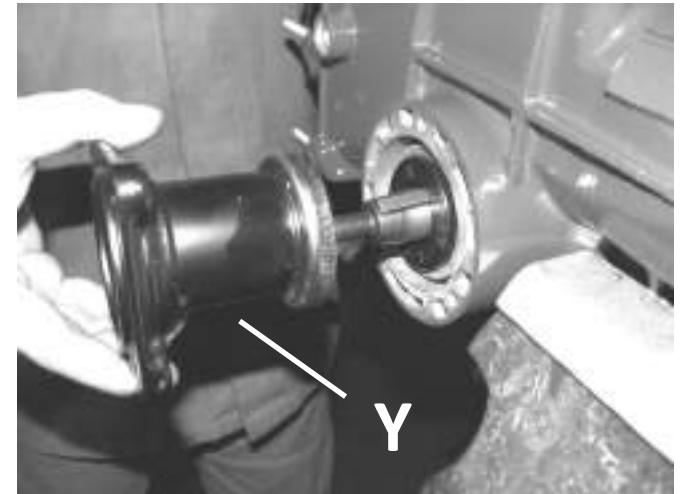



# 17

## Disassembling gearbox 2 Wheels Tractors and Mowers

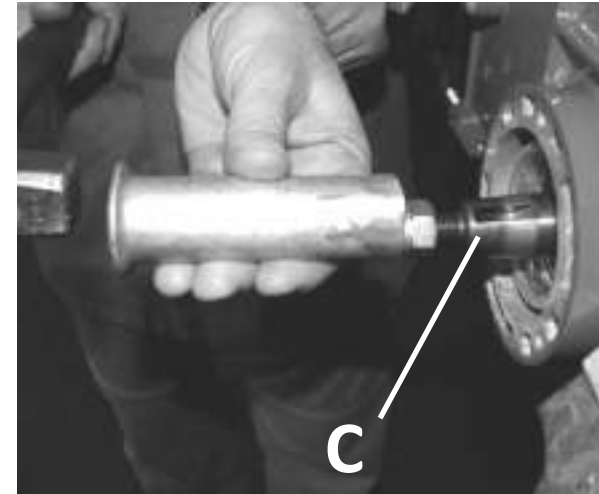
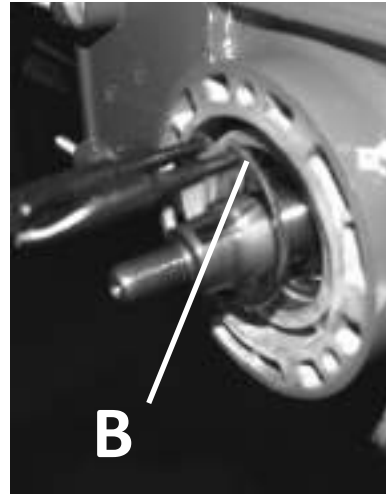
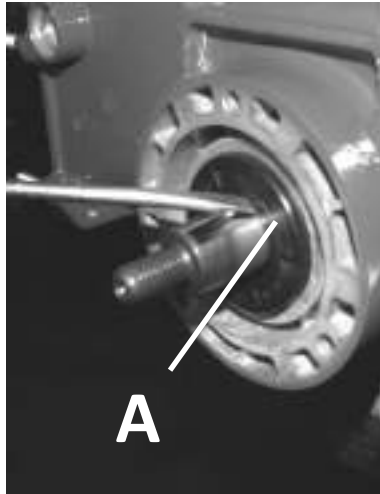

**Remove the key *Z*, the oil seal *A*, the seeger *B* in both sides, remove the shaft *C* with a aluminum cane protecting the thread of the shaft, recover the shaft *C* with the spacers *D* and the crown *W*.**

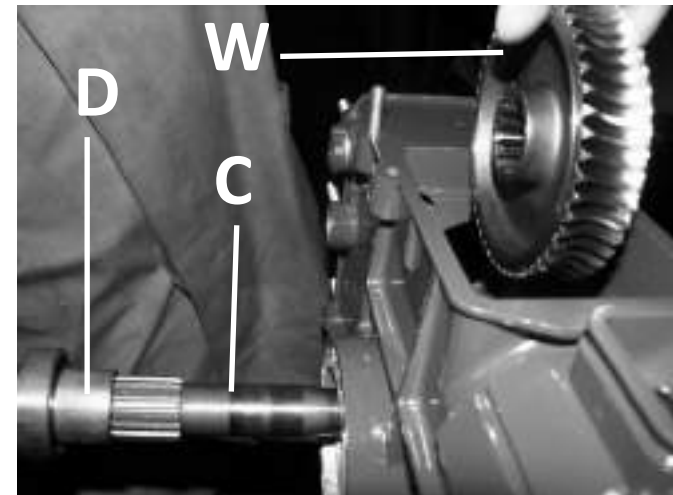

# 18

## Disassembling gearbox 2 Wheels Tractors and Mowers

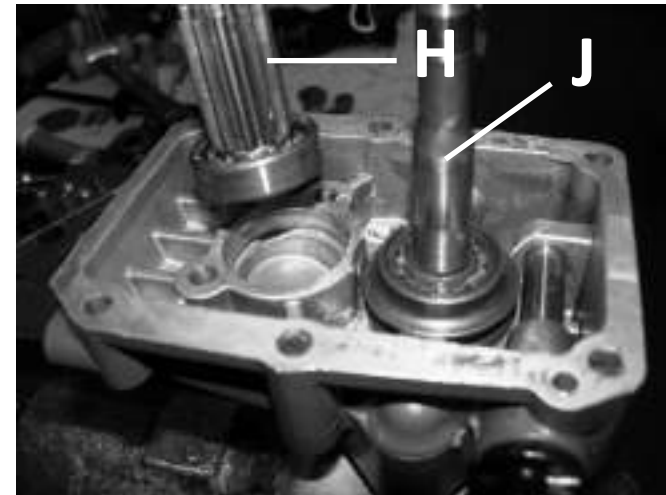
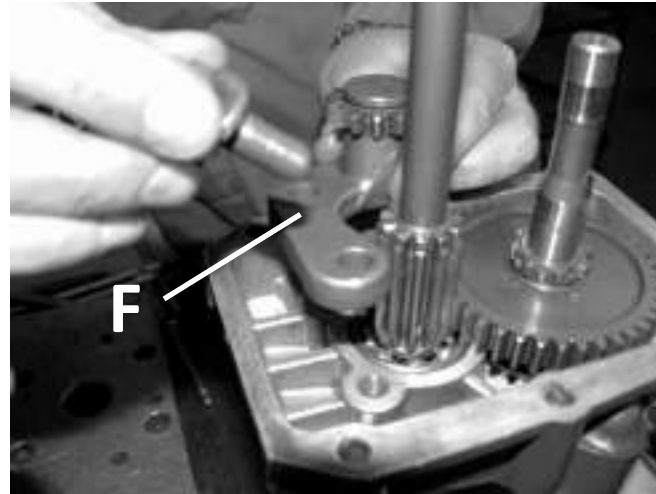
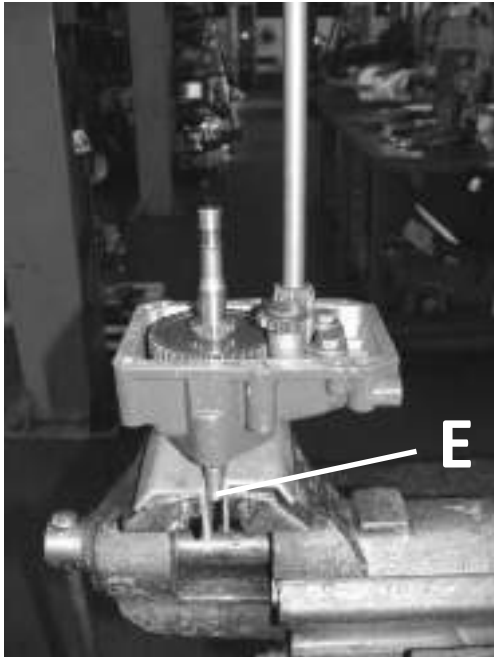

**Dismounting the PTO cover**, put in the clamp the cover with the 2 studs **E** protecting them with aluminum, **Remove** the support of the reverse gear **F**, the gear **G** and the first shaft **H** (shaft of the clutch). *In the old models the gears **G** is complete of the shaft **J**.*

## Disassembling gearbox 2 Wheels Tractors and Mowers

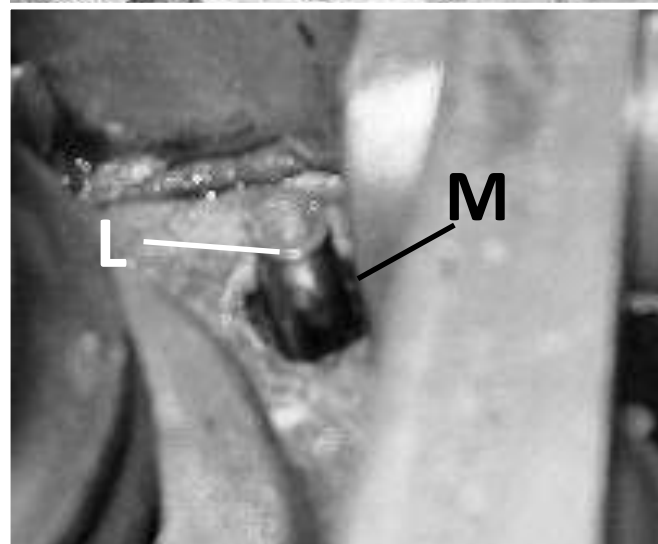
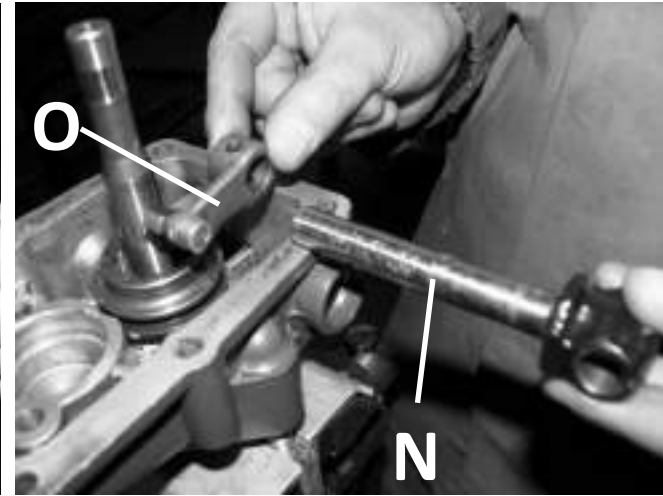
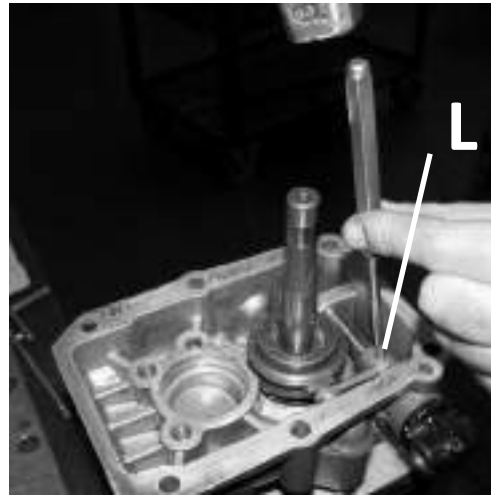
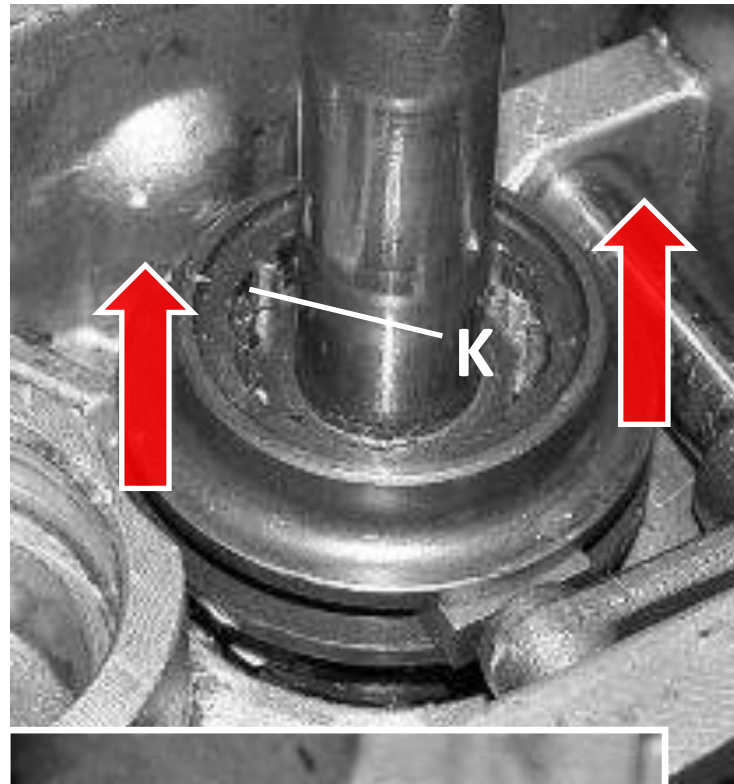

**To dsassemble the lever O and the pivot N, put in high position the coupler K, in this position the pin L is on the centre of the housing M, push off the pin L, dismount the PTO pivot N and the lever O.**

## Disassembling gearbox 2 Wheels Tractors and Mowers

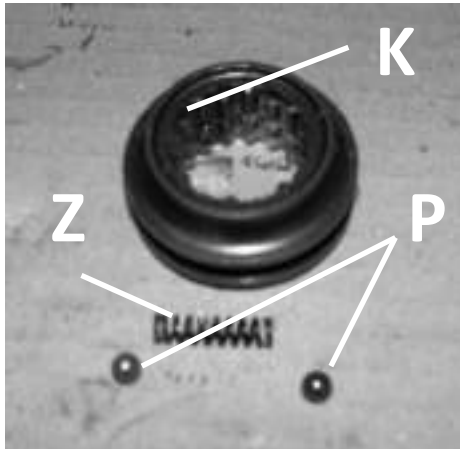
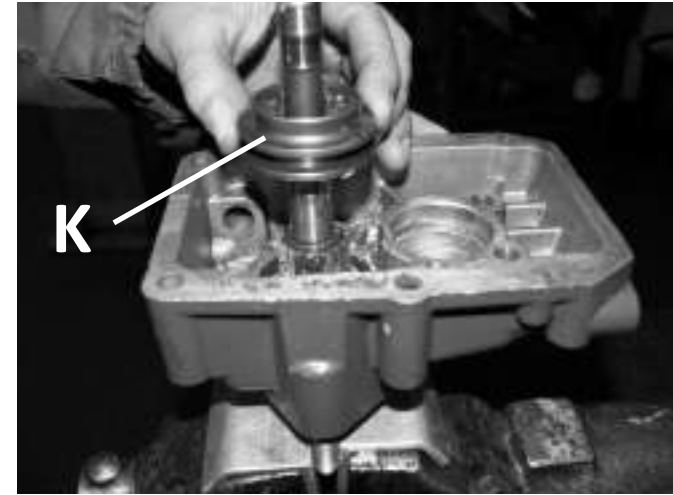
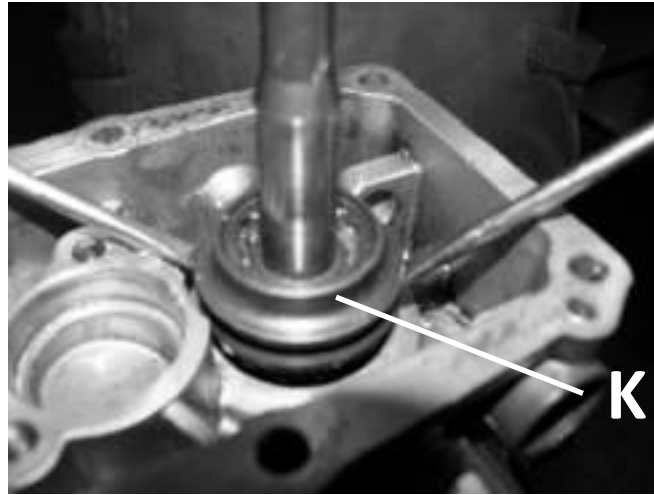

**Recover** the pin **L**, with the aid of 2 screw-drivers **dismount** the coupler **K**, recover the spring **Z** and the 2 balls **P**.

*On the old models the PTO coupler is in the external side of the cover, it is possible to **dismount** the coupler from the table 7.*

## Disassembling gearbox 2 Wheels Tractors and Mowers

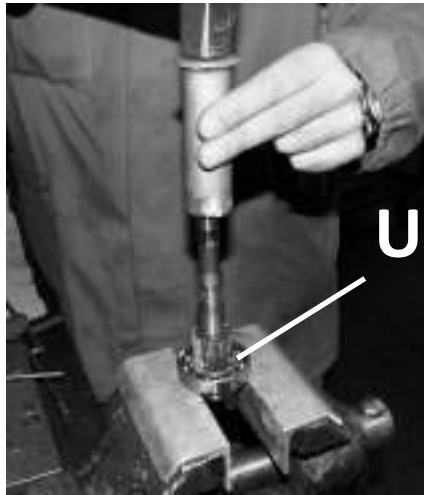
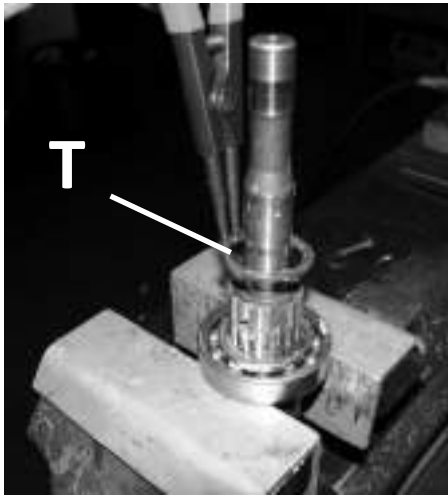
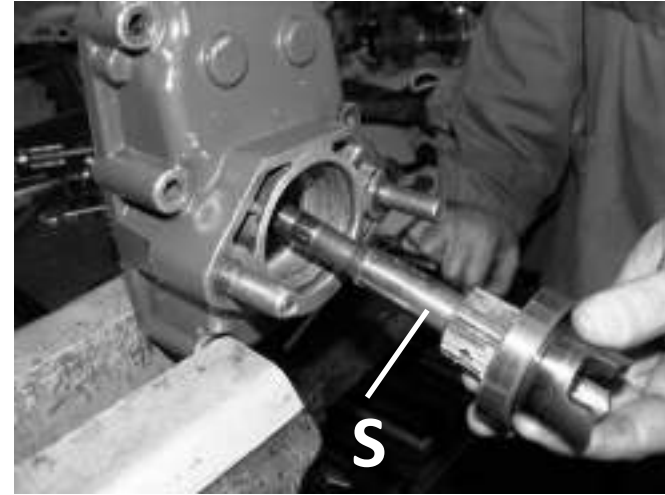
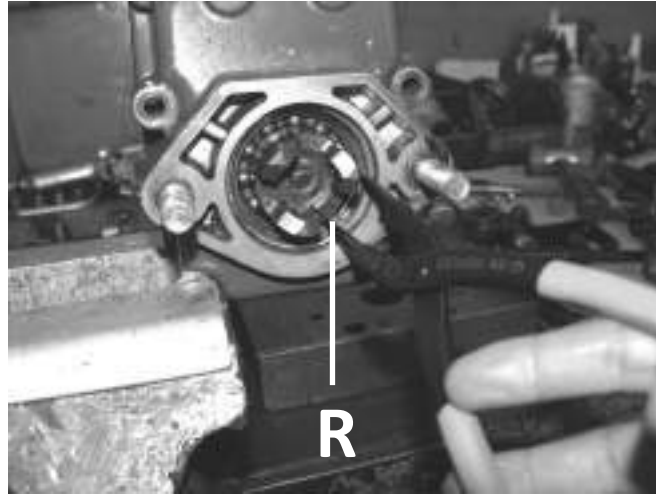
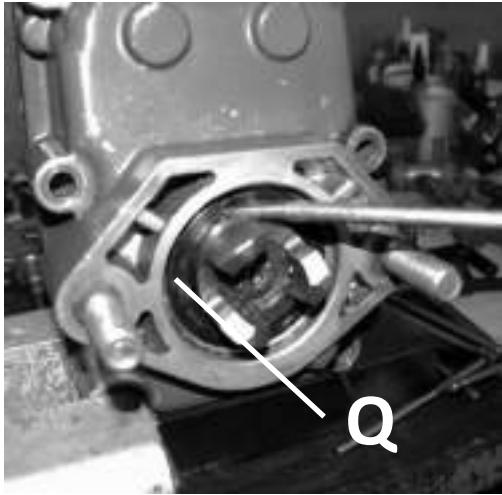

**Take off** the oil seal **Q** and the seeger ring **R**, take off the PTO shaft **S**, take off the seeger ring **T**, remove the bearing **U**.

## Disassembling gearbox 2 Wheels Tractors and Mowers

**ATTENTION:** from this point we start to remount the gearbox, in the case needs to change some wear components or bearings or external parts to the gearbox ect. is necessary refer exclusively to the specific **EXPLODED TABLES** and to the **SERIAL NUMBER** for every model of machine. The exploded tables are available on BCS site, the s/n. is positioned on the gearbox, punched in the space 1 or 2 in figure A. For the sealant see table 26.

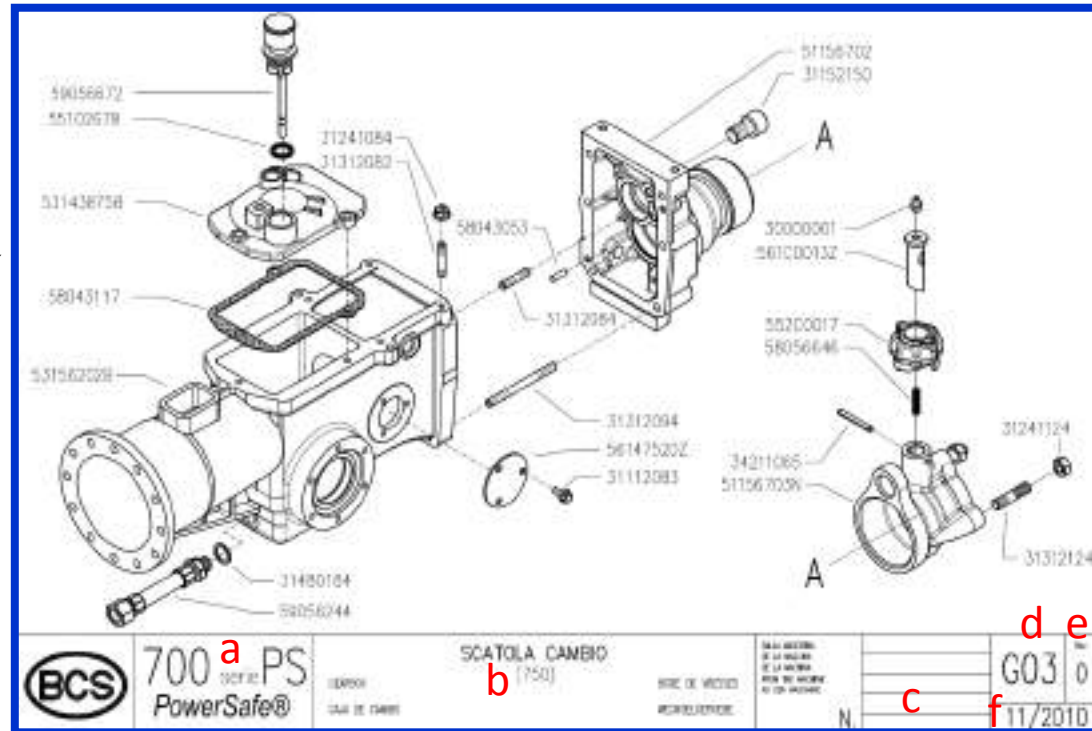
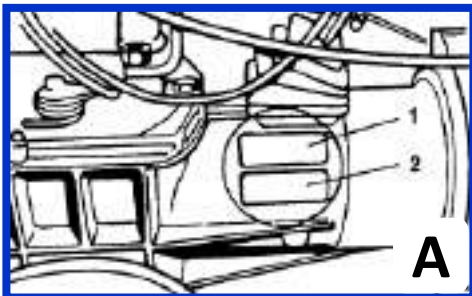

*a – family*  
*b – model*  
*c – serial number*  
*d – table number*  
*e – revision*  
*f - date*

## Disassembling gearbox 2 Wheels Tractors and Mowers

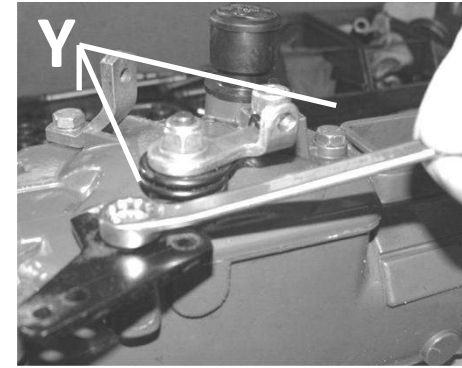
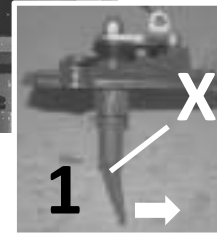
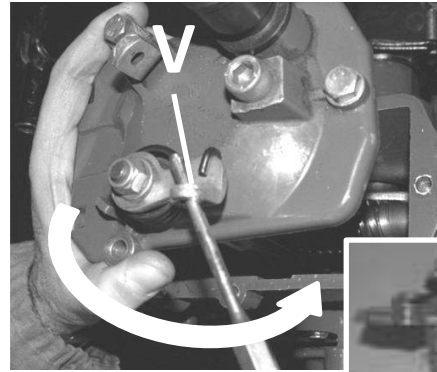
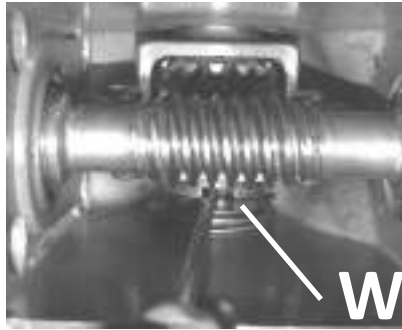
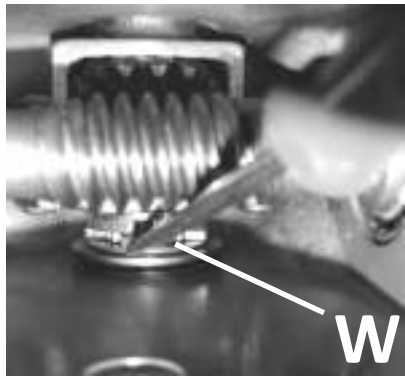

**REMOUNT** the left and right semi-axes proceeding to the contrary of as shown in table 6, introduce the differential group in the gearbox and mount the semi-axes as shown in the tables 15, 14, 13, 12 and 5, **open the coupler W** positioning tooth against tooth, turn in centre the pin **X** of the differential lock of the top cover and put it up on the gearbox, with one hand keep down the cover and tighten the 3 screws **Y**, then release the pin of the differential lock.

(\*)

For the silycone sealant see table 26

## Disassembling gearbox 2 Wheels Tractors and Mowers

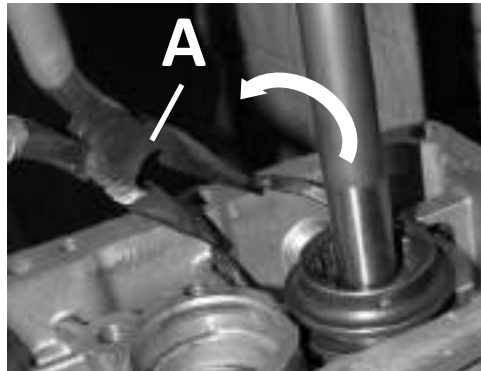
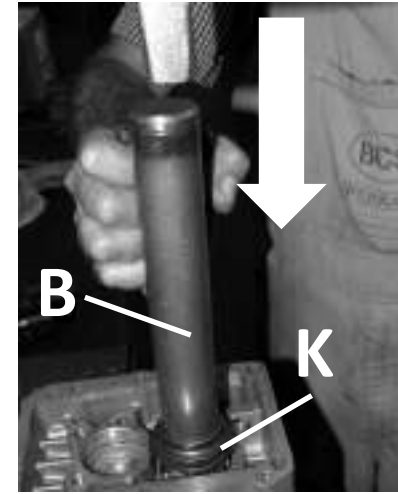
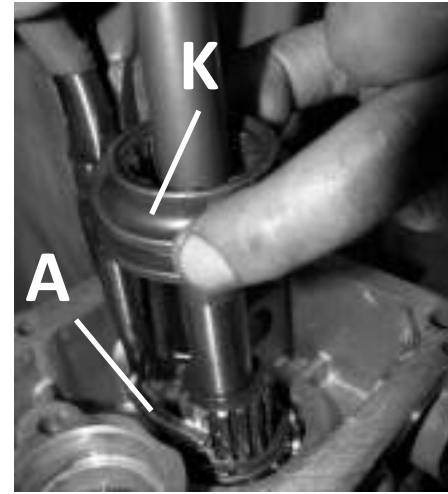
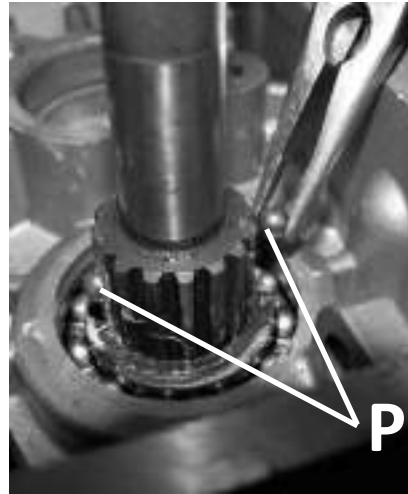
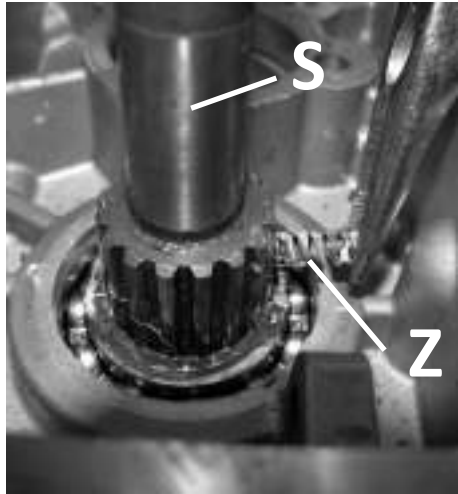

---

Proceeding at the contrary of as shown on table 21, remount the PTO shaft **S** on the rear cover, lubricate with grease the spring **Z** and introduce it on the hole of the PTO shaft, with grease introduce in the two sides of the hole the two balls **P** and take them compressed with the special tongs **A**, mount the PTO coupler **K** and with a tube **B** of right dimension and an hammer beat a decisive coup on coupler **K**, check if the balls are in correct position inside the coupler, remove the tongs **A**.



**Finish to remount** the cover with reverse support and the clutch shaft starting from table 19 and proceed to the contrary until the table 2 (\*).

Tighten the screw of the clutch, to the engine (or to the gearbox if old model) at 3 kgm (table 2)

Tighten the 6 nuts **S** of the rear cover at 2,7 kgm (table 7)

Tighten the 2 nuts **X** of the wheels's hubs at 8,5 Kgm (machines without differential) (table 16)

Tighten the 6 nuts **L** of the semi-axles at 2,7 kgm (machines with differential) (table 5)

Tighten the 2 screws M10 of the reverse support at 5 kgm (table 18)

For the tightenings above, always use adhesive as Loctite strong threadlocker

For the adjustment and the correct mounting see also table 27

To fit the clutches on engines with cylindrical shaft see table 28

(\*) per il sigillante silicone vedere la favola 26

For the silicone sealant see table 26

## Disassembling gearbox 2 Wheels Tractors and Mowers

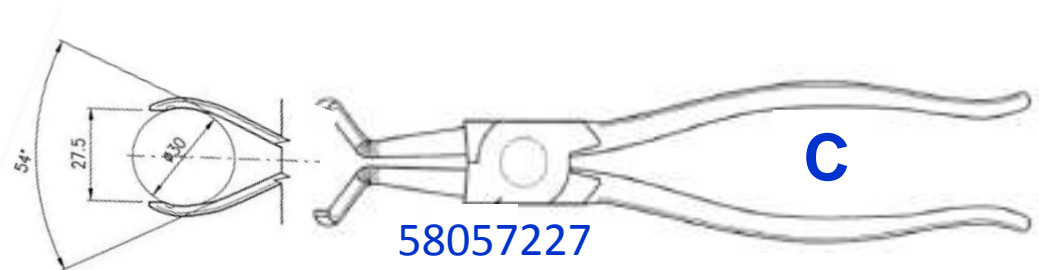
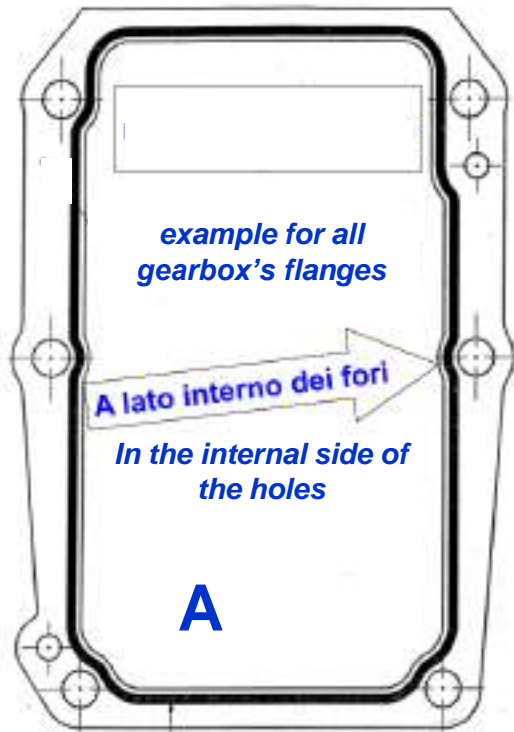

Special tongs to mount the PTO balls

For the adjustment and the correct mounting see also tables 27 and 28

# Smontaggio cambio Motocoltivatori e Motofalciatrici Disassembling gearbox 2 Wheels Tractors and Mowers

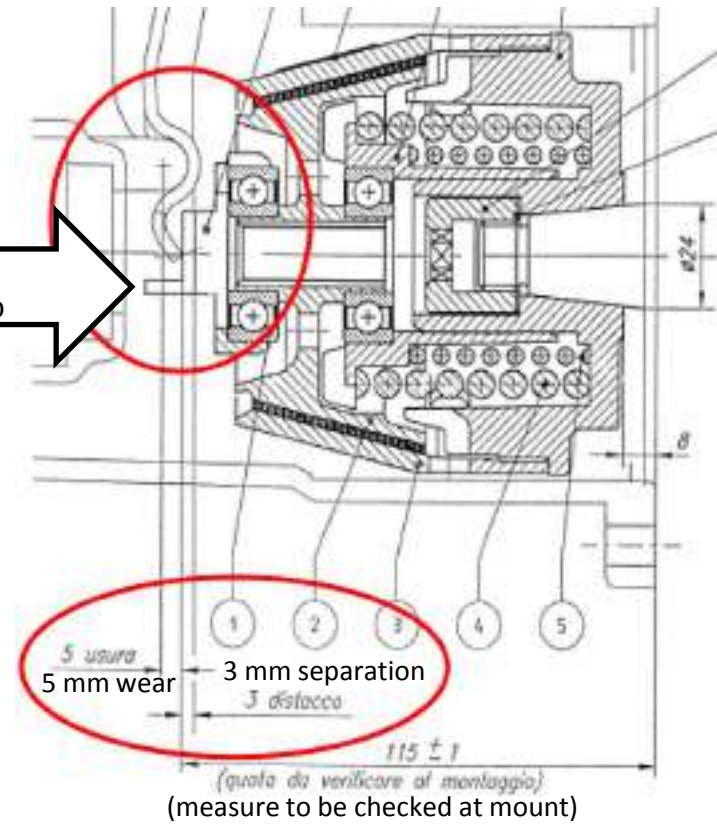
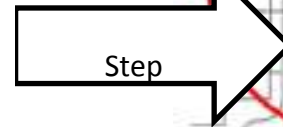
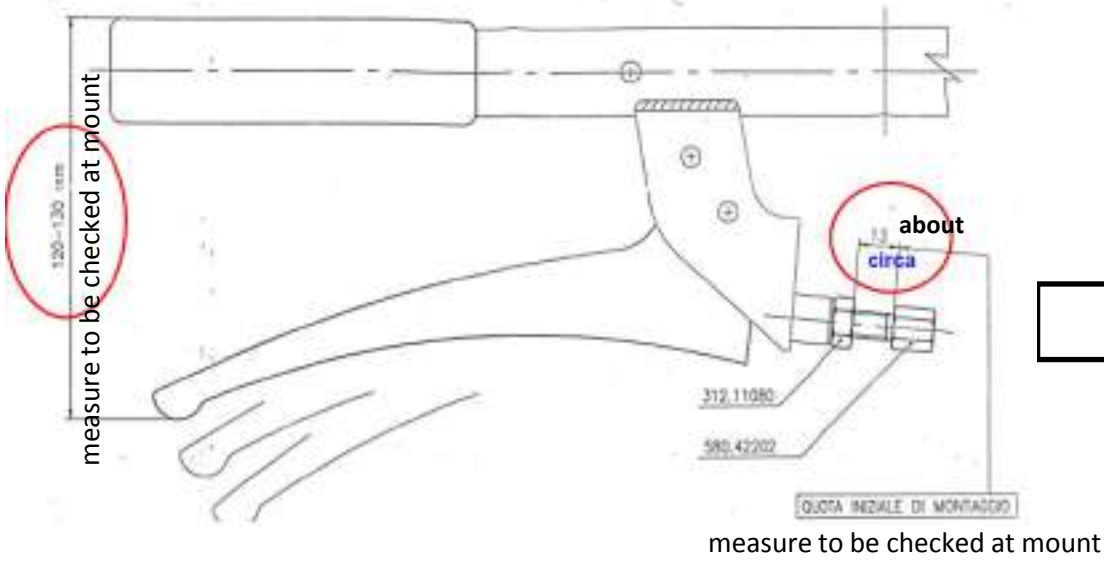

## Disassembling gearbox 2 Wheels Tractors and Mowers



1 togliere la vite  
*Take out the screw*



2 togliere la frizione e la chiavetta  
*Take out the old clutch and the key*



3 togliere il cuscinetto  
*Take out the bearing*



4 inserire il distanziale  
*Introduce the spacer*



5 mandare in battuta il distanziale  
*Put in position the spacer*



6 montare la bussola conica  
*Fit the special conic bushing*



7 montare la nuova frizione  
*Fit the new clutch*



8 serrare la vite con la chiave in dotazione alla frizione  
*Tighten the screw with the special wrench*

**Attenzione:** la chiavetta non viene più montata, l'albero motore deve essere ben liscio e senza rigonfiamenti lungo la sede della chiavetta.

*The key is not fitted more, the engine shaft has to be smooth and without protuberance along the key place.*